

F24-800

Description:

The F24-800 is a single primary and dual secondary, split bobbin design which operates with an input of 115V. The output voltage will be either 24.0V with a center-tap under a 0.8A load with the secondaries wired in series, or 12.0V under a 1.6A load with the secondaries wired in parallel. The split bobbin design eliminates the need for costly electrostatic shielding.

Electrical Specifications (@25C)

1. Maximum Power: 20.0VA
2. Primary: 115V
3. Secondary: Series: 24.0V CT@ 0.8A
Parallel: 12.0V @ 1.6A
4. Voltage Regulation: 25% TYP @ full load to no load
5. Temperature Rise: 25C TYP
6. Hipot tested 100% at 2500 VRMS

Construction:

Three flange bobbin construction with primaries and secondaries wound side by side for low capacitive coupling.

Agency File:

UL: File E53148, UL 5085-2 (506), Class B General Purpose Transformer,
cUL: File E53148, UL 5085-2 (506), Class B General Purpose Transformer,
Canadian Use (CSA 22.2, No.66.2-06)

This model is also available in Class 2, UL 5085-3 (1585) version as [F24-800-C2](#)



Dimensions:

Units in inches.

H	W	L	A	B	C	D	E	F
1.437	1.875	2.25	0.300	0.400	1.600	0.041	0.020	0.234

Weight: 0.80 lbs

Schematic:

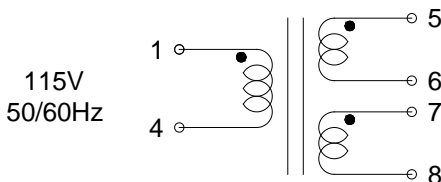

RoHS Compliance: As of manufacturing date February 2005, all standard products meet the requirements of 2011/65/EU, known as the RoHS initiative.

As of April 7, 2008, UL standards 506 and 1585 will be migrated to UL 5085-2 and 5085-3, respectively.

*Upon printing, this document is considered "uncontrolled". Please contact Triad Magnetics website for the most current version. For soldering and washing information please see <http://www.triadmagnetics.com/faq.html>

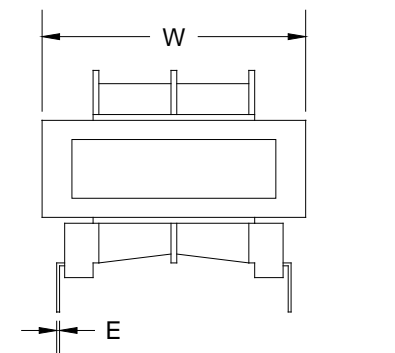

Board Layout

X-ON Electronics

Largest Supplier of Electrical and Electronic Components

Click to view similar products for [Power Transformers](#) category:

Click to view products by [Triad](#) manufacturer:

Other Similar products are found below :

[1-1672275-3](#) [A41-43-20A20](#) [DST5-120B39](#) [14A-56-36B42](#) [EN2997SE61808F8](#) [9-1611461-2](#) [29768](#) [1654308-1](#) [170R](#) [ST2-12B42](#) [ST3-12B5](#) [ST6118T-R](#) [PE-68421NL](#) [PL2.5-12-130B-C](#) [PoE4W3x5.0-R](#) [POE7W3X3.3-R](#) [4000-20C02K999](#) [4001-09W15AE777](#) [48RO-5000G-SIL](#) [TRA-0130-R](#) [XON7-15/2](#) [47045010](#) [1-1611760-0](#) [EN2997SE61808F9](#) [OPT110F-EAS00004AU](#) [XON25-9/24](#) [XON01349](#) [XON01200](#) [XDCA001/INER01](#) [PE-68414NL](#) [F-91X](#) [F-29U](#) [DST4-16B10](#) [DP241-8-24A55](#) [P-8577](#) [T50-24M3](#) [1-1672277-2](#) [1-1672277-0](#) [1-1672275-5](#) [1-1672275-0](#) [PC-24-180B18](#) [750315837](#) [750315125](#) [POE13W2VERS-R](#) [PA2380NL](#) [14A-10-12B9](#) [PE-68411NL](#) [750315126](#) [DPC-28-160B50](#) [PA0803NL](#)