

PH CONNECTOR

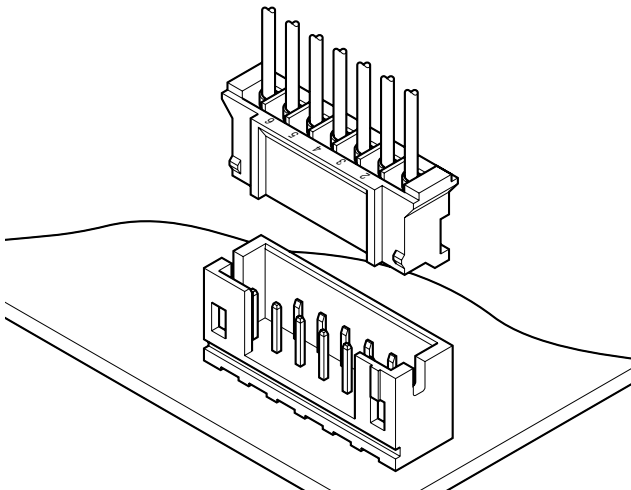

2.0mm pitch/Disconnectable Crimp style connectors



This is a thin, low-profile 2.0mm pitch connector 8.0mm in height after mounting and 4.5mm in width. It is designed to meet the demand for high-density connection of internal wires to printed circuit boards. It is compact, highly reliable and low in cost.

- **Reliable contact**
- **Fully shrouded header**
- **Printed circuit board retention mechanism**
- **Surface mount model (SMT)**

Specifications

- Current rating: 2A AC, DC (AWG #24)
- Voltage rating: 100V AC, DC
- Temperature range: -25°C to +85°C
(including temperature rise in applying electrical current)
- Contact resistance: Initial value/10m Ω max.
After environmental testing/20m Ω max.
- Insulation resistance: 1,000M Ω min.
- Withstanding voltage: 800V AC/minute
- Applicable wire: AWG #32 to #24
- Applicable PC board thickness: 0.8 to 1.6mm
- * Compliant with RoHS.
- * Refer to "General Instruction and Notice when using Terminals and Connectors" at the end of this catalog.
- * Contact JST for details.

Standards

- Ⓜ Recognized E60389
- Ⓢ Certified LR20812
- ⚠ R75087

PC board layout and Assembly layout

〈Through-hole type (viewed from soldering side)〉

Top entry type

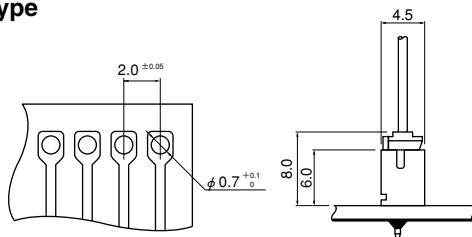

Side entry type

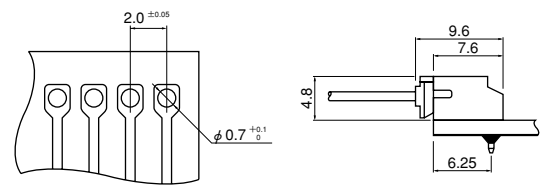

Note: 1. Tolerances are non-cumulative: ±0.05mm for all centers.

2. Hole dimensions differ according to the kind of PC board and piercing method. If PC boards made of hard material are used, the hole dimensions should be larger. The dimensions above should serve as a guideline. Contact JST for details.

〈SMT type (viewed from component side)〉

SM4 type

Top entry type

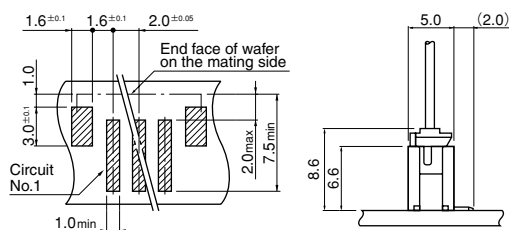

Side entry type

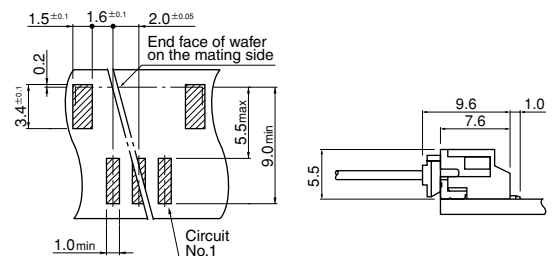

Note: 1. Tolerances are non-cumulative: ±0.05mm for all centers.

2. The dimensions above should serve as a guideline. Contact JST for details.

PH CONNECTOR

Contact

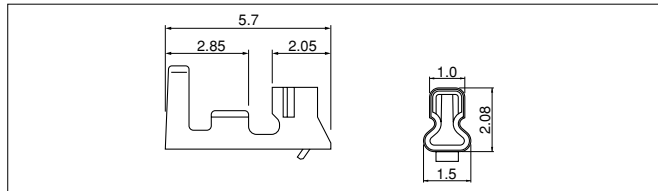

Contact	Crimping machine	Applicator		
		Crimp applicator	Dies	Crimp applicator with dies
SPH-002T-P0.5S	AP-K2N	MKS-LS · MKS-L	MK/SPH-002-05S	APLMK SPH002-05S
		*MKS-SC	SC/SPH-002-05S	APLSC SPH002-05S
SPH-002T-P0.5L		MKS-LS · MKS-L	MK/SPH-002-05L	APLMK SPH002-05L
		*MKS-SC	SC/SPH-002-05L	APLSC SPH002-05L
SPH-004T-P0.5S	MKS-L-10	MK/SPH-004-05S	APLMK SPH004-05S	
	*MKS-SC-10	SC/SPH-004-05S	APLSC SPH004-05S	

Note: *Strip-crimp applicator

Model No.	Applicable wire			Q'ty / reel
	mm ²	AWG #	Insulation O.D. (mm)	
SPH-002T-P0.5S	0.05 ~ 0.22	30~24	0.9~1.5	8,000
SPH-002T-P0.5L	0.08 ~ 0.22	28~24	0.8~1.5	
SPH-004T-P0.5S	0.032~0.08	32~28	0.5~0.9	10,000

Material and Finish

Phosphor bronze, tin-plated (reflow treatment)

RoHS compliance

Note:

- Contact JST for gold-plated products.
- SPH-002T-P0.5L is low-insertion force type contact, for easier insertion/withdrawal, which would be less resistant to the vibration. The crimp height is different from the standard.
- Contact JST for details.

Housing

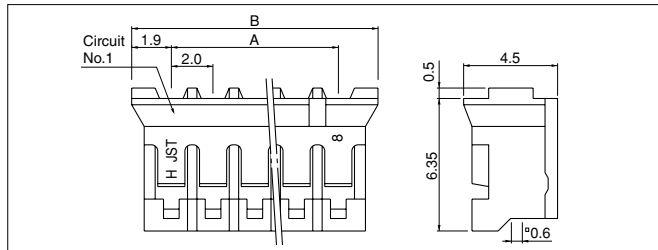

<For reference> As the color identification, the following alphabet shall be put in the underlined part. For availability, delivery and minimum order quantity, contact JST.

ex. **PHR-2-oo**

(blank)...natural (white)

BK...black R...red TR...tomato red BL...blue Y...yellow

L...lemon yellow M...green D...orange N...brown

P...purple PK...pink H...gray LE...light blue

FY...vivid yellow DPK...dark pink

Circuits	Model No.	Dimensions (mm)		Q'ty / box
		A	B	
2	PHR-2	2.0	5.8	1,000
3	PHR-3	4.0	7.8	1,000
4	PHR-4	6.0	9.8	1,000
5	PHR-5	8.0	11.8	1,000
6	PHR-6	10.0	13.8	1,000
7	PHR-7	12.0	15.8	1,000
8	PHR-8	14.0	17.8	1,000
9	PHR-9	16.0	19.8	1,000
10	PHR-10	18.0	21.8	1,000
11	PHR-11	20.0	23.8	1,000
12	PHR-12	22.0	25.8	1,000
13	PHR-13	24.0	27.8	1,000
14	PHR-14	26.0	29.8	1,000
15	PHR-15	28.0	31.8	1,000
16	PHR-16	30.0	33.8	1,000

Material

PA 66, UL94V-0, natural (white)

RoHS compliance

Through-hole type shrouded header

Top entry type

(2 circuits)

(3 circuits or more)

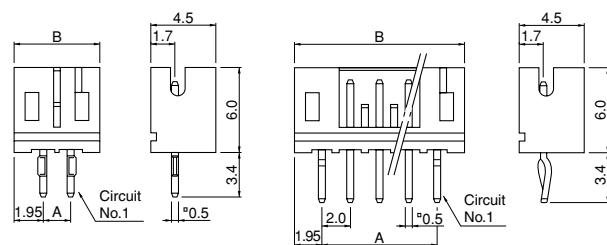

Side entry type

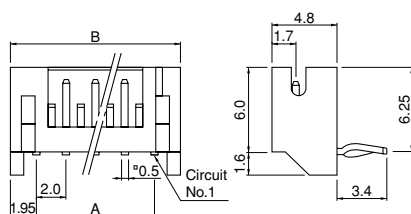

Circuits	Model No.		Dimensions (mm)		Q'ty / box	
	Top entry type	Side entry type	A	B	Top entry type	Side entry type
2	B2B-PH-K-S	S2B-PH-K-S	2.0	5.9	1,000	1,000
3	B3B-PH-K-S	S3B-PH-K-S	4.0	7.9	1,000	1,000
4	B4B-PH-K-S	S4B-PH-K-S	6.0	9.9	1,000	500
5	B5B-PH-K-S	S5B-PH-K-S	8.0	11.9	1,000	500
6	B6B-PH-K-S	S6B-PH-K-S	10.0	13.9	1,000	500
7	B7B-PH-K-S	S7B-PH-K-S	12.0	15.9	500	500
8	B8B-PH-K-S	S8B-PH-K-S	14.0	17.9	500	250
9	B9B-PH-K-S	S9B-PH-K-S	16.0	19.9	500	250
10	B10B-PH-K-S	S10B-PH-K-S	18.0	21.9	500	250
11	B11B-PH-K-S	S11B-PH-K-S	20.0	23.9	500	250
12	B12B-PH-K-S	S12B-PH-K-S	22.0	25.9	400	250
13	B13B-PH-K-S	S13B-PH-K-S	24.0	27.9	250	250
14	B14B-PH-K-S	S14B-PH-K-S	26.0	29.9	250	250
15	B15B-PH-K-S	S15B-PH-K-S	28.0	31.9	250	200
16	B16B-PH-K-S	S16B-PH-K-S	30.0	33.9	250	200

Material and Finish

Post: Brass, copper-undercoated, tin-plated (reflow treatment)
Wafer: PA 66, UL94V-0, natural (white)

RoHS compliance

This product displays (LF)(SN) on a label.
<For reference> As the color identification, the following alphabet shall be put in the underlined part. For availability, delivery and minimum order quantity, contact JST.

ex. **B2B-PH-K-oo**

S...natural (white)

K...black R...red TR...tomato red

E...blue Y...yellow L...lemon yellow M...green

O...orange N...brown P...purple PK...pink H...gray

LE...light blue FY...vivid yellow (blank)...ivory

PH CONNECTOR

Through-hole type shrouded header <Low insertion force type>

Top entry type

(2 circuits)

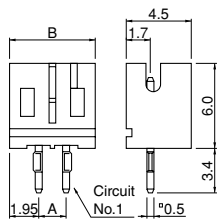

(3 circuits or more)

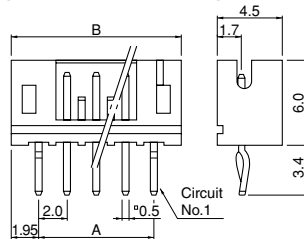

Side entry type

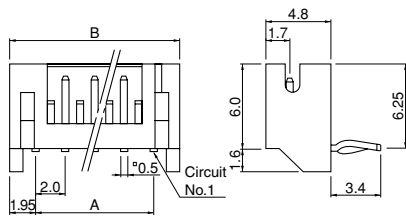

Circuits	Model No.		Dimensions (mm)		Q'ty / box	
	Top entry type	Side entry type	A	B	Top entry type	Side entry type
2	B2B-PH-KL	S2B-PH-KL	2.0	5.9	1,000	1,000
3	B3B-PH-KL	S3B-PH-KL	4.0	7.9	1,000	1,000
4	B4B-PH-KL	S4B-PH-KL	6.0	9.9	1,000	500
5	B5B-PH-KL	S5B-PH-KL	8.0	11.9	1,000	500
6	B6B-PH-KL	S6B-PH-KL	10.0	13.9	1,000	500
7	B7B-PH-KL	S7B-PH-KL	12.0	15.9	500	500
8	B8B-PH-KL	S8B-PH-KL	14.0	17.9	500	250
9	B9B-PH-KL	S9B-PH-KL	16.0	19.9	500	250
10	B10B-PH-KL	S10B-PH-KL	18.0	21.9	500	250
11	B11B-PH-KL	S11B-PH-KL	20.0	23.9	500	250
12	B12B-PH-KL	S12B-PH-KL	22.0	25.9	400	250
13	B13B-PH-KL	S13B-PH-KL	24.0	27.9	250	250
14	B14B-PH-KL	S14B-PH-KL	26.0	29.9	250	200
15	B15B-PH-KL	S15B-PH-KL	28.0	31.9	250	200
16	B16B-PH-KL	S16B-PH-KL	30.0	33.9	250	200

Material and Finish

Post: Copper alloy, copper-undercoated, tin-plated (reflow treatment)
Wafer: PA 66, UL94V-0, gray

RoHS compliance This product displays (LF)(SN) on a label.

<For reference> As the color identification, the following alphabet shall be put in the underlined part. For availability, delivery and minimum order quantity, contact JST.

ex. **B2B-PH-KL-oo**
(blank)...gray
R...red E...blue S...natural (white)

SMT type shrouded header

Top entry type

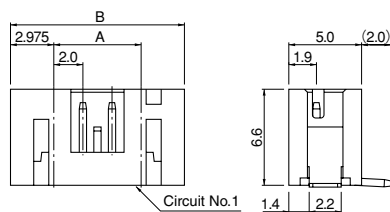

Side entry type

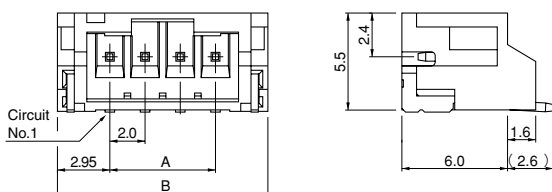

Circuits	Model No.		Dimensions (mm)			Q'ty / reel
	Top entry type	Side entry type	A	B		
				Top entry type	Side entry type	
2	B2B-PH-SM4-TB	S2B-PH-SM4-TB	2.0	7.95	7.9	1,000
3	B3B-PH-SM4-TB	S3B-PH-SM4-TB	4.0	9.95	9.9	1,000
4	B4B-PH-SM4-TB	S4B-PH-SM4-TB	6.0	11.95	11.9	1,000
5	B5B-PH-SM4-TB	S5B-PH-SM4-TB	8.0	13.95	13.9	1,000
6	B6B-PH-SM4-TB	S6B-PH-SM4-TB	10.0	15.95	15.9	1,000
7	B7B-PH-SM4-TB	S7B-PH-SM4-TB	12.0	17.95	17.9	1,000
8	B8B-PH-SM4-TB	S8B-PH-SM4-TB	14.0	19.95	19.9	1,000
9	B9B-PH-SM4-TB	S9B-PH-SM4-TB	16.0	21.95	21.9	1,000
10	B10B-PH-SM4-TB	S10B-PH-SM4-TB	18.0	23.95	23.9	1,000
11	B11B-PH-SM4-TB	S11B-PH-SM4-TB	20.0	25.95	25.9	1,000
12	B12B-PH-SM4-TB	S12B-PH-SM4-TB	22.0	27.95	27.9	1,000
13	B13B-PH-SM4-TB	S13B-PH-SM4-TB	24.0	29.95	29.9	1,000
14	B14B-PH-SM4-TB	S14B-PH-SM4-TB	26.0	31.95	31.9	1,000
15	B15B-PH-SM4-TB	S15B-PH-SM4-TB	28.0	33.95	33.9	1,000
16	B16B-PH-SM4-TB	—	30.0	35.95	—	1,000

Material and Finish

Post: Copper alloy, copper-undercoated, tin-plated (reflow treatment)
Wafer: PA, UL94V-0, natural (ivory)
Solder tab: Brass, copper-undercoated, tin-plated (reflow treatment)

RoHS compliance This product displays (LF)(SN) on a label.

Note: Contact JST for the top entry type headers with suction cap.

<For reference> As the color identification, the following alphabet shall be put in the underlined part. For availability, delivery and minimum order quantity, contact JST.

ex. **B2B-PH-SM4-oo-TB**
(blank)...natural (ivory)
R...red E...blue M...green L...lemon yellow K...black
DPK...dark pink

X-ON Electronics

Largest Supplier of Electrical and Electronic Components

Click to view similar products for [Headers & Wire Housings](#) category:

Click to view products by [JST](#) manufacturer:

Other Similar products are found below :

[95000-104TRLF](#) [10135584-644402LF](#) [DF62W-EP2022PCA](#) [95000-106TRLF](#) [DF62W-2022SCA](#) [DF62W-EP2022PC](#) [2203348](#) [DF62W-2022SC](#) [1084018](#) [1029039](#) [1084017](#) [802-10-012-10-002000](#) [1112640](#) [1112639](#) [000-34000](#) [0009482033](#) [0009507031](#) [57102-S06-03LF](#) [57202-S52-04LF](#) [PCN6-15S-2.5E](#) [0039019024](#) [58102-G61-06LF](#) [582553-1](#) [0009485154](#) [0009508121](#) [0022285053](#) [0050291907](#) [018731A](#) [LY20-4P-DT1-P1E-BR](#) [02.125.8002.8](#) [60101931](#) [60598-1 \(Cut Strip\)](#) [M1625-3R/100](#) [61062-3](#) [61082-181009](#) [636-1427](#) [638009-1](#) [641938-9](#) [641991-4](#) [644168-1](#) [647662-1](#) [65039-019ELF](#) [65781-047](#) [65817-002LF](#) [65817-015LF](#) [65863-015LF](#) [66207-023LF](#) [67016-026LF](#) [67046-001LF](#) [67095-007LF](#)