

Sensors Mating Cordsets

4 and 5-Pin *eurofast*® Field Wireable



Application	Specifications	Straight/Female	Right Angle/ Female	Straight/Male	Right Angle/ Male
Mates with standard key 4-pin cordsets and receptacles	125 VAC / 150 VDC, 3.0 A PG 7 cable gland, accepts 4-6 mm cable Screw terminals	B 8141-0	B 8241-0	BS 8141-0	BS 8241-0
Mates with standard key 5-pin cordsets and receptacles	30 VAC / 36 VDC, 3.0 A PG 9 cable gland, accepts 4-8 mm cable Screw terminals	B 8151-0	B 8251-0	BS 8151-0	BS 8251-0

B 814(5)1-0

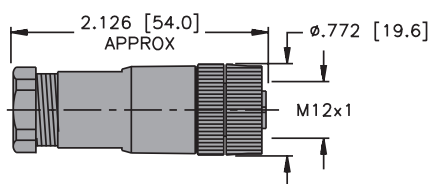

Female Connector

BS 814(5)1-0

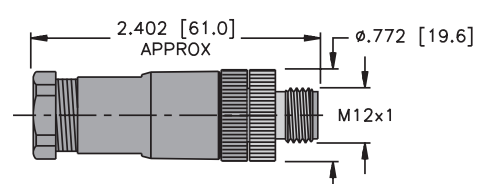

Male Connector

B 824(5)1-0

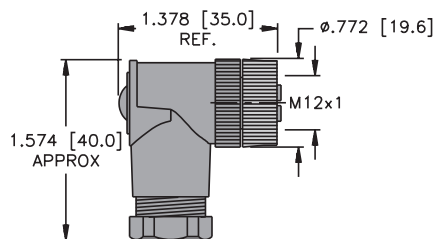

Female Connector

BS 824(5)1-0

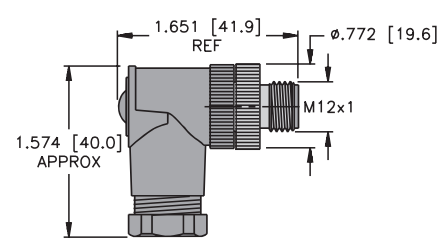

Male Connector

Pinouts

Female		Male	
4-Pin	5-Pin	4-Pin	5-Pin

**Industrial
Automation**

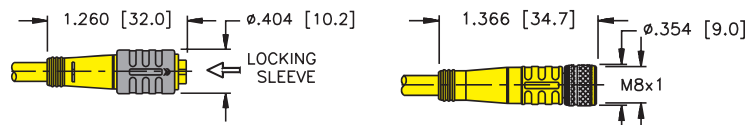

**3-Pin *picofast*®
Cordset
Standard Plug Body
125 VAC/VDC, 4 A**

3-Pin

Application	Part Number	Cable Specifications	Pinout
3-Wire <i>picofast</i> Snap Lock Connection CSA Certified	PKG 3Z-*	3/24 AWG Yellow PVC 105°C 4.4 mm OD	1. BN 3. BU 4. BK
	PKG 3Z-*/S90	3/24 AWG Black PUR 80°C 4.4 mm OD	1. BN 3. BU 4. BK
3-Wire <i>picofast</i> Threaded Connection CSA Certified	PKG 3M-*	3/24 AWG Yellow PVC 105°C 4.4 mm OD	1. Bn 3. Bu 4. Bk
	PKG 3M-*/S90	3/24 AWG Black PUR 80°C 4.4 mm OD	1. Bn 3. Bu 4. Bk

Cords - Acc

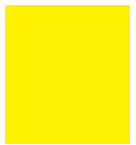

Pinouts

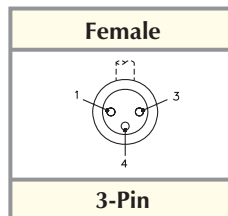

FEMALE PIN-OUT - END VIEW

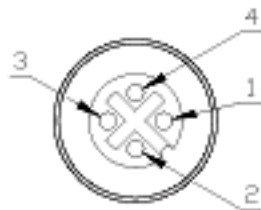

SPECIFICATIONS

HOUSING MATERIAL/PLATING	PA/BLACK
CONTACT MATERIAL/PLATING	NICKEL PLATED BRASS
COUPLING NUT MATERIAL/PLATING	PBT
RATED CURRENT [A]	3.0 A
RATED VOLTAGE [V]	125 V
MAXIMUM WIRE SIZE	18 AWG
CABLE GRIP RANGE	4-8 mm
TEMPERATURE RATING	-40°C to +85°C (-40°F to +185°F)
PROTECTION CLASS	MEETS NEMA 1,3,4,6,13 AND IEC IP67
SPACINGS [VDE 0110 b]	125 VAC/150 VDC, Gr. C

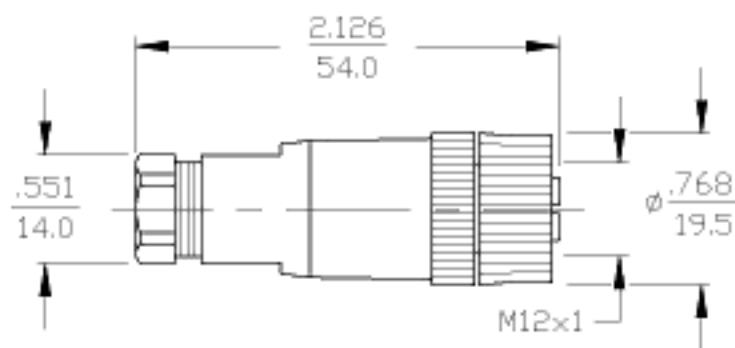

MATERIAL		3RD ANGLE PROJECTION		TURCK INC		
FINISH						
DRFT	JMS	DATE	10/9/95	PART NO./DESCR.		
DSGN			Y#	B-8141-0		
DIMENSION UNITS: INCHES [MILLIMETERS]				SIZE	ID NO.	REV
				A	U6545	A
				SCALE	EUR\FW\U6545	SHEET OF
				NONE		

A	SEE REVISION DOCUMENT U6545	JMS	10/9/95	T1416
REV	DESCRIPTION	DRFT	DATE	ECO NO.
REVISIONS				

X-ON Electronics

Largest Supplier of Electrical and Electronic Components

Click to view similar products for [turck](#) manufacturer:

Other Similar products are found below :

[BI10-M30-AP6X-H1141](#) [BI2-G12-AZ33X-7M](#) [BS4151-0/13.5](#) [NI12U-G18-ADZ30X2-B1331](#) [NI12U-M18-AN4X](#) [BI1.5-G08K-AN6X](#) [BI5-G18-AZ3X](#) [BI5-G18-AZ3X-B1331-50MM](#) [VB20](#) [B 5143-0](#) [BI 2-EG08K-AP6X-V1131](#) [BMWS 8151-0/9](#) [BI30U-CK40-AP6X2-H1141](#) [NI12U-M18-AP6X-H1141](#) [NI4U-EG08-AN6X-H1341](#) [NI5-G12-AP6X-H1141](#) [NI14-G18-ADZ30X2](#) [BC10-QF5.5-RN6X2](#) [PKG 3M-4/S90](#) [B1N360V-Q20L60-2LU3-H1151](#) [FKFD 4.5](#) [RK40-2M](#) [BI5-G18-AP6X-B1441/S34](#) [NI3-EG08K-Y1-H1341](#) [BCF5-S18-RP4X/S90](#) [BI5-M18-Y0X-H1141](#) [NI35U-CK40-ADZ30X2-B3131 W/BS4](#) [WK 4T-2](#) [IM1-22EX-T](#) [RK 4T-10](#) [NI12U-MT18-AP4X-H1141](#) [BI1.5-EG08-AP6X-H1341](#) [BC 5-Q08-AP6X2-V1131](#) [BC5-S18-Y1X](#) [CT 2-A30/M](#) [C10-T13X/024VDC](#) [FDN20-4S-4XSG-E](#) [FKV-CC](#) [FSFD 8](#) [NI4U-EG08-RP6X-V1131](#) [CMBS 8141-0](#) [FEN20-16DXP](#) [BI10-M30-AN6X-H1141](#) [VB80-P7X9-8/CS12](#) [FKFD 8](#) [RI360P0-QR24M0-INCRX2-H1181](#) [PKW 3M-6](#) [NI8-M18E-VN4X](#) [WK 4.5T-2/S618](#) [BI8U-M18-AP6X-H1141](#)