



GROOVE14 EF/TY

BASIC ALUMINIUM RECESSED PROFILE

PODSTAWOWY, ALUMINIOWY PROFIL WPUSTOWY

- decorative and lighting profile
- used mainly in furniture
- maximum LED strip width: 14 mm
- profil dekoracyjno-oświetleniowy
- głównie do zastosowania meblowego
- maksymalna szerokość taśmy LED: 14 mm

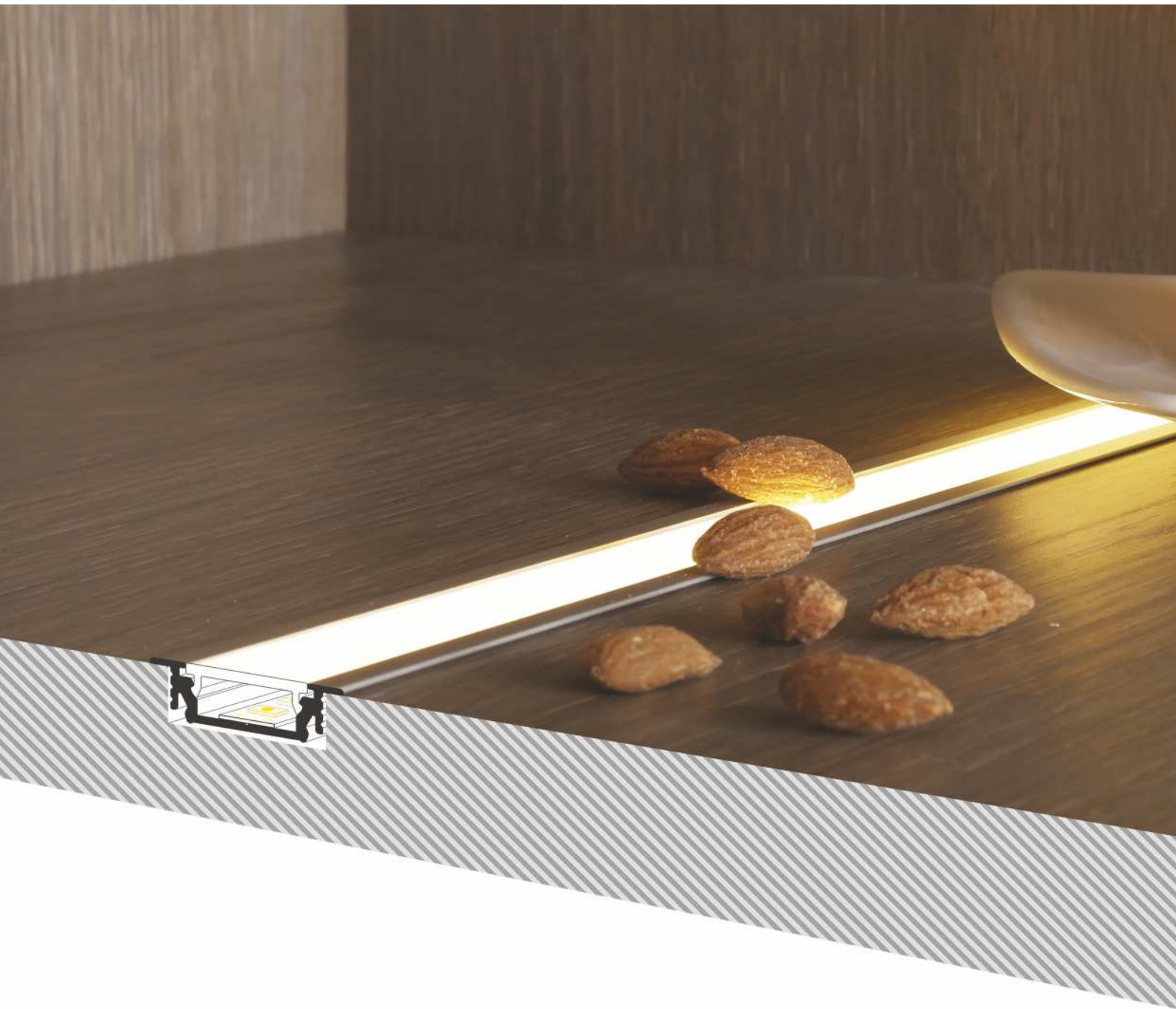

SIMILAR IN THE OFFER / PODOBNE W OFERCIE



DEEP10
BC/UX



GROOVE10
BC/UX



TRIO10
BC



UNI12
BCD/U



GROOVE14 EF/TY

- E** slide cover
klosz E wsuwany
- F** click cover
klosz F klik
- Y¹** flexible mounting plate
uchwyt Y sprężysty
- Y²** cone Y flexible mounting plate
uchwyt Y sprężysty cone
- T** mounting plate
uchwyt T

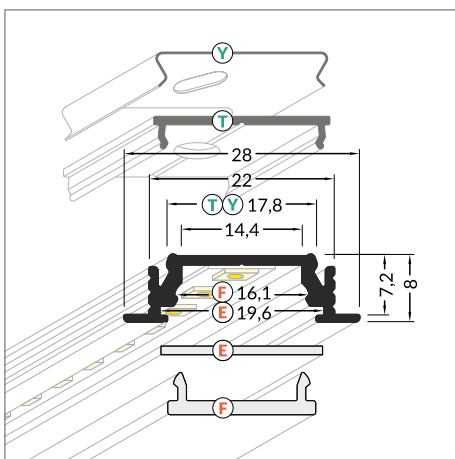
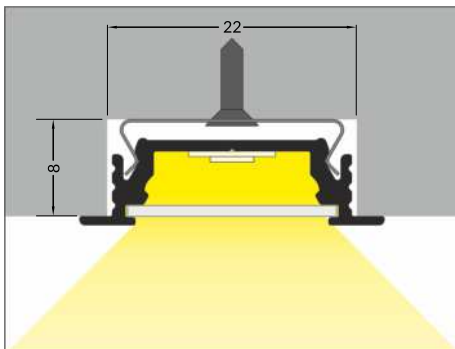
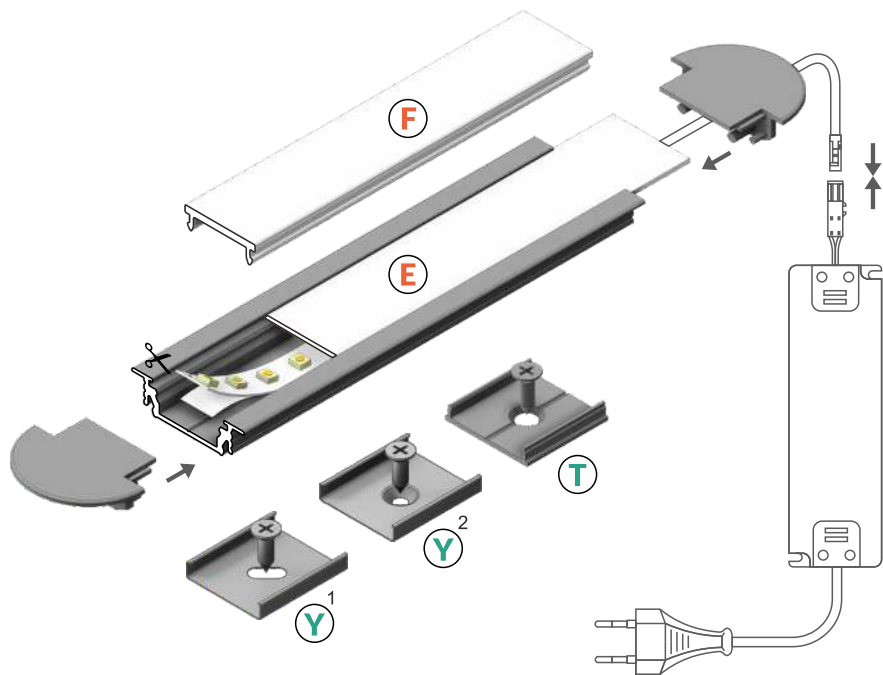

INDEX = 1 pc, length 2000 mm
package = 10 pcs
INDEKS = 1 szt., długość 2000 mm
opakowanie = 10 szt.

 white painted
biały malowany
A3020001

 anodized
anodowany
A3020020

 black anodized
czarny anodowany
A3020021

 raw aluminium
surowe aluminium
A3020000

Available lengths / Dostępne długości
1000 mm, 2000 mm, 3000 mm, 4000 mm



COVERS / KLOSZE

E slide cover

colours: transparent, frosted, white
material: PC, PP, PP

klosz E wsuwany
kolory: przezroczysty, szron, mleczny
materiał: PC, PP, PP



Note! Dimensions of the space to install LED source
Uwaga! Wymiary przestrzeni do zamontowania źródła LED

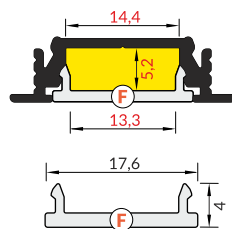
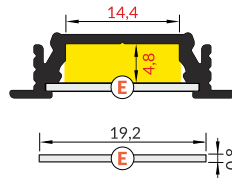

F click cover

colours: transparent, white
material: PMMA

klosz F klik
kolory: przezroczysty, mleczny
materiał: PMMA

E7 click cover
colour: white
material: PMMA



klosz E7 klik
kolor: mleczny
materiał: PMMA

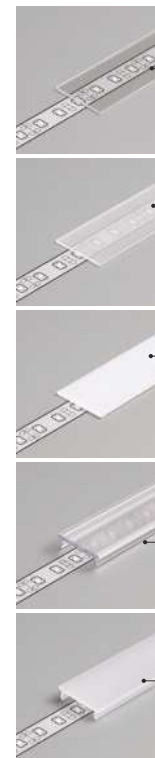
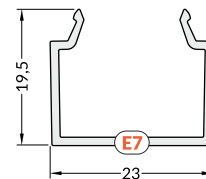

INDEX = 1 pc, length 2000 mm
package = 10 pcs
INDEKS = 1 szt., długość 2000 mm
opakowanie = 10 szt.

E transparent / E transparentny
A2040016

E frosted / E szron
A2040039

E white / E mleczny
A2040038

F transparent / F transparentny
A2060016

F white / F mleczny
A2060038

E7 white / E7 mleczny
C1080038

E7 white ending
zaślepka E7 mleczny
C1840038

MOUNTINGS / MOCOWANIA

Y flexible mounting plate

colour: inox
material: stainless steel

uchwyt Y sprężysty
kolor: inox
materiał: stal nierdzewna

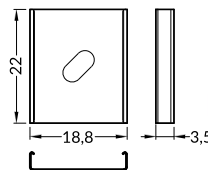
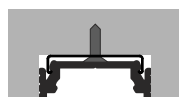

cone Y flexible mounting plate

colour: inox
material: stainless steel

uchwyt Y sprężysty cone
kolor: inox
materiał: stal nierdzewna

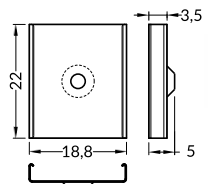

T mounting plate
colour: raw aluminium
material: aluminium

uchwyt T
kolor: surowe aluminium
materiał: aluminium

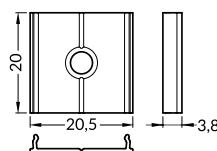
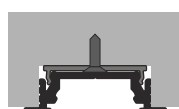

INDEX = 1 set
package of 10 sets = 20 pcs
INDEKS = 1 komplet, opakowanie
zawiera 10 kompletów = 20 szt.

Y flexible mounting plate
uchwyt Y sprężysty

inox
inox A2090019

cone Y flexible mounting plate
uchwyt Y sprężysty cone

inox
inox A2130019

T mounting plate
uchwyt T

raw aluminium
surowe aluminium
C6960000



ENDINGS / ZAŚLEPKI

GROOVE14 ending with hole
colours: white, silver, black, grey
material: ABS

zaślepka GROOVE14 z otworem
kolory: biały, srebrny, czarny, szary
materiał: ABS

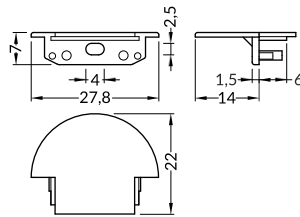

INDEX = 1 set
package of 10 sets = 20 pcs
INDEKS = 1 komplet, opakowanie
zawiera 10 kompletów = 20 szt.

	white białe	A3100001
	silver srebrne	A3100040
	black czarne	A3100002
	grey szare	A3100022

CONNECTORS / ŁĄCZNIKI

T connector
colour: raw aluminium
material: aluminium

łącznik T
kolor: surowe aluminium
materiał: aluminium

GROOVE14 connector 90 deg
colours: white, anodized, black
material: aluminium

łącznik GROOVE14 90 st
kolory: biały, anodowany, czarny
materiał: aluminium

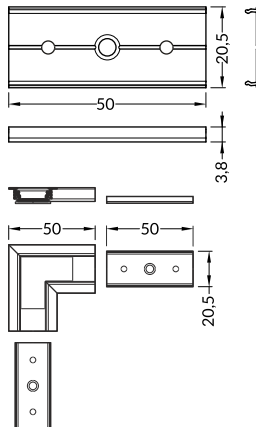

INDEX = 1 set
INDEKS = 1 komplet

T connector / łącznik T

raw aluminium
surowe aluminium
C6990000

connector 90 deg / łącznik 90 st

	white painted biały malowany	A3990001
	anodized anodowany	A3990020
	black anodized czarny anodowany	A3990021

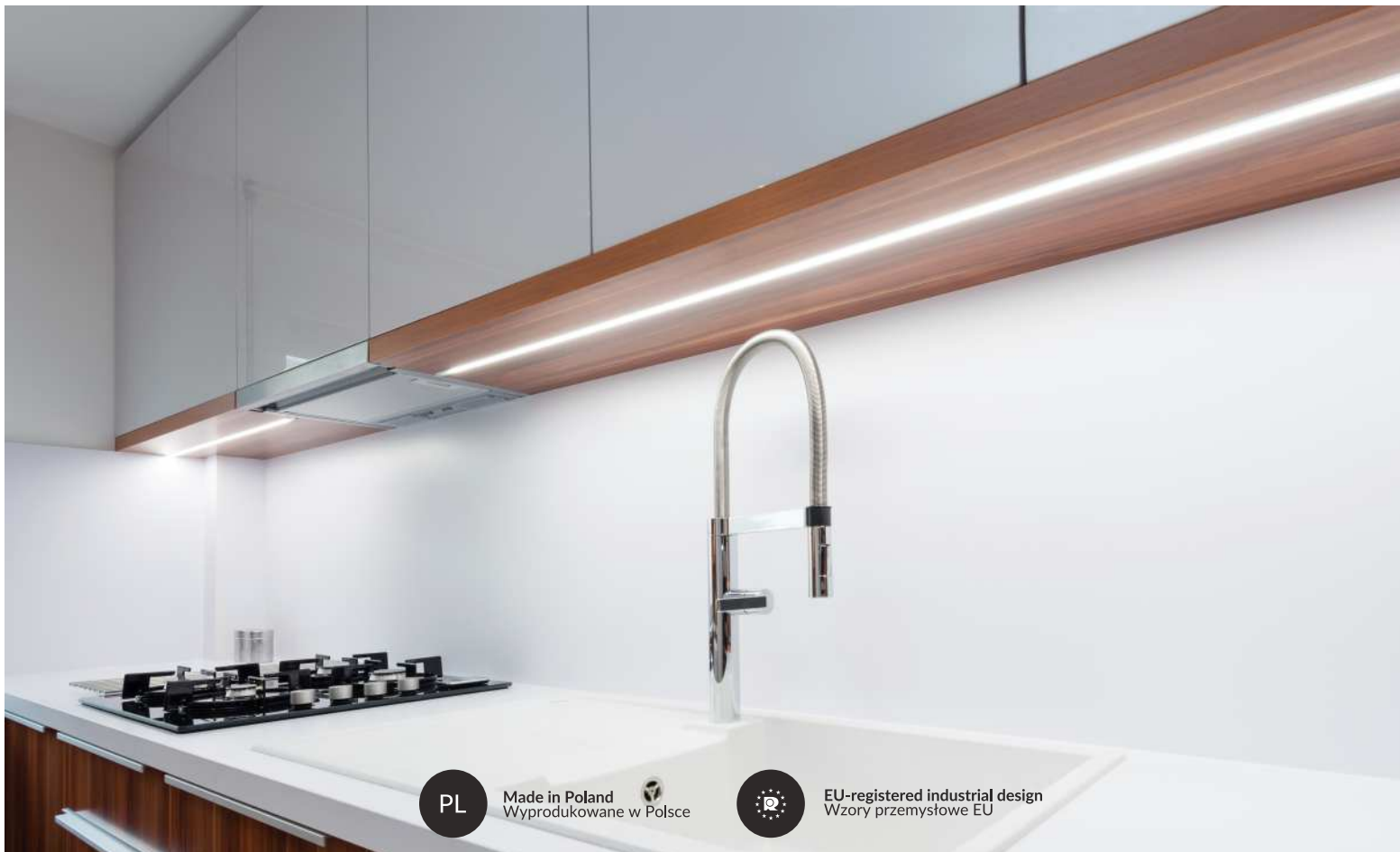

PL

Made in Poland
Wyprodukowane w Polsce



EU-registered industrial design
Wzory przemysłowe EU

X-ON Electronics

Largest Supplier of Electrical and Electronic Components

Click to view similar products for [LED Lighting Mounting Accessories](#) category:

Click to view products by [Topmet](#) manufacturer:

Other Similar products are found below :

[3635](#) [C16142_HEKLA-SOCKET-K](#) [3SU1401-1BF20-3AA0](#) [3SU1401-1BF60-3AA0](#) [3SU1900-0BC31-0AA0](#) [3SU1900-0BC31-0NB0](#)
[2213118-2](#) [3SU1401-2BB20-1AA0](#) [3SU1401-2BB40-1AA0](#) [3SU1401-2BB60-1AA0](#) [3SU1401-2BB60-3AA0](#) [1SFA616921R2131](#)
[1SFA616921R2132](#) [1SFA616921R2133](#) [1SFA611621R1033](#) [1SFA611621R1041](#) [1SFA611621R1091](#) [23110022](#) [23110040](#) [23120022](#)
[23130000](#) [68550022](#) [68550040](#) [70290000](#) [70290022](#) [70290040](#) [70300022](#) [76620000](#) [76990022](#) [77280022](#) [77980022](#) [77990001](#) [77990002](#)
[77990040](#) [83130001](#) [83130040](#) [83150001](#) [83150022](#) [83150040](#) [83980001](#) [83980040](#) [83990001](#) [83990022](#) [83990040](#) [84040022](#) [84510002](#)
[86050038](#) [86180003](#) [89080002](#) [89080022](#)