



Ty-Rap® / Ty-Fast® Cable Fastening Systems

Ty-Rap® /Ty-Fast® Cable Tying System
OverviewJ2-J3

Ty-Rap® Cable TiesJ4-J8
Cable Ties for Special EnvironmentsJ9-J10
Cable Ties for Special Applications.....J11

Stainless Steel Cable Ties and
AccessoriesJ12-J13

Multi-Lok Stainless Steel
Self-Locking Cable TiesJ14
Reusable Stainless Steel Cable TiesJ15
Stainless Steel TiesJ17-J19
Free-EndJ16

Customized Embossed Tags
Stainless Steel Tape EmbossingJ20

Stainless Steel I.D. TagJ21

Self-Locking Ties.....J22-J23
Deltec® Cable Ties.....J24-J25

Hook and Loop FastenersJ26

Lashing StrapsJ27-J28

Cables – Materials Selection
Ordering GuideJ29-J33'

Ty-Fast® Cable Ties.....J34-J45

Ty-Fast® Low-Profile In-Line FastenersJ46

Ty-Fast® Badge Holder.....J47

T&B Cable Tie Mounting BasesJ48-J55

T&B Cable Clamps and Clips.....J56-J65

T&B Harnessing Accessories.....J66-J67

T&B Mounting Bases for Heavy-Duty
ApplicationsJ68-J69

T&B Wire Protection ProductsJ70-J73

T&B Braided Expandable Wire Sleeving.....J74-J76

T&B Cable Tie Installation ToolsJ77-J82



Thomas & Betts

Thomas & Betts

Cable Tie Mounting Bases

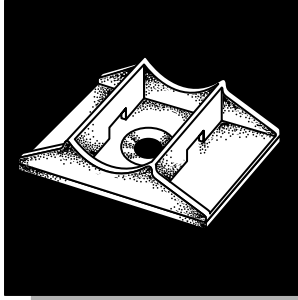

Mounting Cradle

- Accepts cable ties to 50# tensile (miniature through standard).
- Supplied on closed cell foam with synthetic polymer "rubber" based adhesive.
- Use #6 self-tapping screw for added strength if desired.
- UL Flammability 94 V-2 (mount).
- Mount molded in 6/6 Natural Nylon.

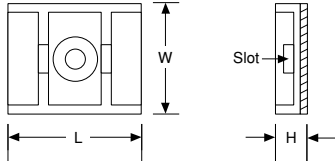

Cat. No.	Material	H Height		L Length		W Width		Slot Height		Slot Width		Mount Method	Bulk Pkg.
		Inch	(mm)	Inch	(mm)	Inch	(mm)	Inch	(mm)	Inch	(mm)		
MCNY-1250-9-D	Natural Nylon	.285	(7.24)	1.250	(31.73)	1.000	(25.40)	.090	(2.29)	.300	(7.62)	Adhesive	500
MCNY-1250-9-C	Natural Nylon	.285	(7.24)	1.250	(31.73)	1.000	(25.40)	.090	(2.29)	.300	(7.62)	Adhesive	100
Tolerance ±		.010	(.254)		.015	(.381)		.010	(.254)				

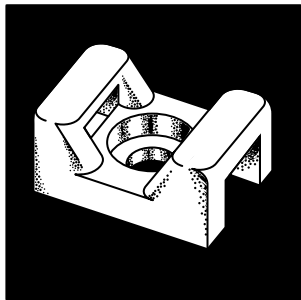

Screw Mount

- SMNY-001 accepts cable ties to 50# Tensile (miniature through standard).
- SMNY-002 accepts cable ties to 120# Tensile (miniature through heavy duty).
- Use #4, #6, #8 or #10 machine screw (as referenced) to apply.
- Stocked in 6/6 Natural or heat stabilized Black Nylon.
- UL Flammability 94 V-2.

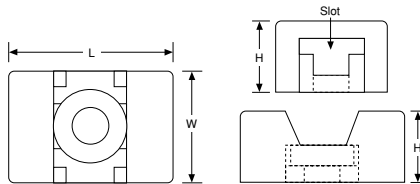

Cat. No.	Material	H Height		L Length		W Width		Slot Height		Slot Width		Mount Method	Bulk Pkg.
		Inch	(mm)	Inch	(mm)	Inch	(mm)	Inch	(mm)	Inch	(mm)		
SMNY-000-9-D	Natural Nylon	.270	(6.86)	.570	(14.48)	.340	(8.64)	.070	(1.78)	.120	(3.10)	#4 Screw	500
SMNY-001-9-D	Natural Nylon	.280	(7.11)	.600	(15.24)	.385	(9.77)	.060	(1.52)	.200	(5.08)	#6, #8 Screw	500
SMNY-002-9-C	Natural Nylon	.390	(9.90)	.875	(22.22)	.625	(15.87)	.090	(2.29)	.325	(8.26)	#8, #10 Screw	100
SMNY-002-9-D	Natural Nylon	.390	(9.90)	.875	(22.22)	.625	(15.87)	.090	(2.29)	.325	(8.26)	#8, #10 Screw	500
SMNY-001-0-D	Heat Stabilized Black Nylon	.280	(7.11)	.600	(15.24)	.385	(9.77)	.060	(1.52)	.200	(5.08)	#6, #8 Screw	500
SMNY-002-0-C	Heat Stabilized Black Nylon	.390	(9.90)	.875	(22.22)	.625	(15.87)	.090	(2.29)	.325	(8.26)	#8, #10 Screw	100
SMNY-002-0-D	Heat Stabilized Black Nylon	.390	(9.90)	.875	(22.22)	.625	(15.87)	.090	(2.29)	.325	(8.26)	#8, #10 Screw	500
Tolerance ±						.015	(.381)						



Ty-Rap® / Ty-Fast® Cable Tying System



Installers Know and Trust Fastening Products from Thomas & Betts

Wire bundling is an integral part of modern electrical and electronic installations. To finish your harnessing and bundling project as reliably and economically as possible, choose genuine Ty-Rap® and Ty-Fast® cable ties. These fastening systems include a full range of cable ties, identification ties, clamps, bases, harnessing aids and installing tools. Using T&B fastening systems for all wiring jobs, large and small, will speed and improve the reliability of harnessing and wire bundling while saving you money.

Harnessing

- Harness Board pre-wiring prior to installation.
- Large OEMs - Automotive, Aerospace, Computers, Electronics, Copiers, Appliances and other Durable Goods.

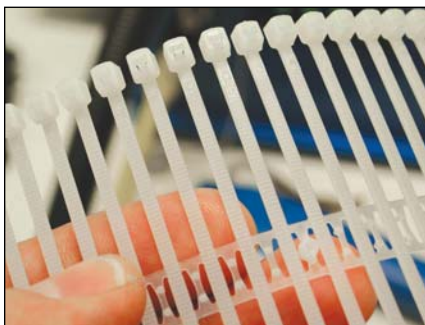

T&B fastening systems for large volume cable tying combine high-speed ergonomically designed automatic and semi-automatic tools, along with a wide selection of ties and



harnessing aids to meet your application requirements. Accessories include various harnessing aids, retainers, supports, posts, pins and guides that allow the wire to be quickly routed with or without the use of nails.

Point-to-point and Long Distance Wiring

- Bundling & fastening cables between equipment.
- Panel & Machine Tool Builders.
- Industrial & Commercial Applications, Refineries, Office Buildings.

Installers prefer the ease of use and exceptional durability of genuine Ty-Rap® cable ties. Engineered for labor savings and high performance, Ty-Rap® cable ties are commonly used in a variety of applications. Standoffs, bulkhead mounting bases, adhesive mounting bases and a wide variety of clamping devices will meet or exceed any requirements. Weatherable and special material Ty-Rap® cable ties are exceptionally suited for years of service in extreme environments.

Other Applications

- HVAC
- Recreational
- Telecom & Utility
- Packaging

Ty-Rap® and Ty-Fast® cable ties are remarkably well suited for a variety of other non-electrical applications. Ty-Rap® cable ties exceed UL requirements for smoke developed and heat release for use in air handling spaces. Ty-Rap® cable ties meet international standards such as CSA and CE as well as UL, , Belcor, ADC and military specifications in North America. T&B also offers a complete stainless steel and Deltec cable fastening system for demanding and weather-resistant applications. Choose genuine Ty-Rap® cable ties for the rugged "Grip of Steel" or economical Ty-Fast® cable ties for lighter-duty service.

Choose Genuine Ty-Rap® and Ty-Fast® Cable Ties from Thomas & Betts

When you choose a cable tie from T&B, you can count on quality, performance and innovation to make your work easier. Depending on your application, choose genuine Ty-Rap® Cable ties or Ty-Fast® Cable Ties, along with our wide assortment of quality accessories and installing tools to make installation hassle-free.

Thomas & Betts

Ty-Rap® / Ty-Fast® Cable Tying System



Genuine Ty-Rap® Cable Ties provide industrial strength for the most demanding work.

T&B's Ty-Rap® Cable Ties feature these important advantages:

- **Stainless steel locking device in the head.** Ty-Rap® cable ties are infinitely adjustable within their bundle range. You get the right bundle tightness every time. The 316 stainless steel locking device in the nylon head secures the tie with the longer-lasting, corrosion-resistant "grip of steel," exceeding the minimum pullout strength requirements specified in MIL-S-23190.
- **Smooth body design with smooth rounded edges and uniform cross sections.** The ties have no notches, thereby reducing stress areas that can weaken the tie and cause brittle breakage especially in cold and dry conditions. Smooth

edges won't snag while pulling through bulkheads. There are no sharp edges to be the source of installation injuries or to damage the wire insulation. The smooth surface design also adds an attractive finish to your wiring project.

- **Mechanic's Grip** - No-slip tail for easy grasping and tensioning.
- **Ribbed and stippled inner body** – Prevents slipping on the bundle.
- **Turned-up Tail** - Orients tail to head for easy assembly, easier to pick up on flat surface.

T&B also offers all-stainless steel, hook and loop and specialty material Ty-Rap® cable ties in a large variety of styles, colors and sizes for all your fastening applications.



Ty-Fast® Cable Ties fit the needs of OEMs from start to finish.

T&B's Ty-Fast® Cable Ties feature these important advantages:

- **Smooth Edges** - Designed to prevent cable insulation damage.
- **Integrally formed nylon pawl** – Combines low insertion force and high locking strength.
- **Rounded head** – Reduces snags, makes pulling bundles through tight spaces easier.
- **Two-sided Finger Grip Design** – Helps the installer grasp and pull the tie snug.
- **Tab in center of the Tail** – Keeps the tail from popping out while

being threaded and holds it securely for final tightening.

- **Turned-up Tail** - Orients tail to head for quick assembly, easier to pick up on flat surface.
- **Quick, Easy Pull-Through** – Reduces operator fatigue, increases productivity.
- **Competitively Priced** – Ideal for high volume jobs, lowers installation costs for OEMs.

T&B also offers a low-profile contoured version of Ty-Fast® cable ties, along with a fully automated reel-fed fastening system.



Cable Fastening Accessories

Choose from one of the largest assortments of mounting bases, clips and clamps, spacers, lashing straps, harness board accessories, braided wire sleeve, and accessories for heavy-duty lashing. Use Thomas & Betts cable fastening accessories for the finishing touch on your next wiring project.

Tools

Ty-Rap® and Ty-Fast® installing tools finish the installation of the cable tie. Ties are cinched to the proper tension and the excess tail is cut off precisely flush with the head, leaving no sharp corners or ragged edges. Ty-Rap® and Ty-Fast® installing tools have narrow noses and slim shapes for work in tight spaces or between harness board nails. The operation is quick, reliable and cost effective.

Thomas & Betts

Ty-Rap® Cable Ties

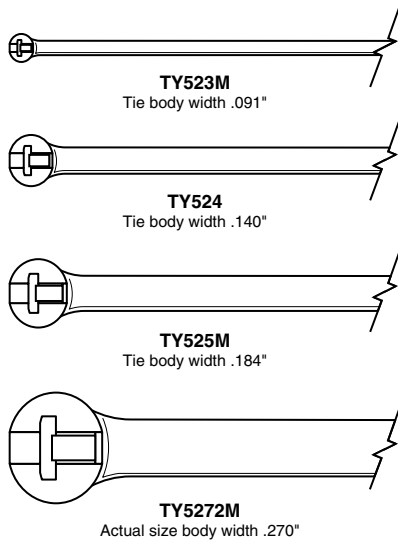

Standard Nylon 6/6 Cable Ties

Std. Cat. No.	Bulk Cat. No.	Body Width (in.)	Length (in.)	Max. Wire Bundle Dia. (in.)	Military Standard Part No.	Tensile Strength (lbs.)	Std. Pkg.	Bulk Pkg.
TY523M	TY23M	.093	3.62	.625	MS3367-4	18	100	1000
TY52315M	TYB2315M	.092	7.00	1.500	-	18	100	1000
TY5232M	TY232M	.086	8.00	2.000	-	18	100	1000
TY5234M	TY234M	.086	14.00	4.000	-	18	100	1000
TY524M	TY24M	.140	5.50	1.125	MS3367-5	30	100	1000
TY5242M	TY242M	.140	8.19	2.000	-	30	100	1000
TY526M	TY26M	.140	11.10	3.000	-	40	100	1000
TY5244M	TY244M	.140	14.50	4.000	-	30	100	1000
TY525M	TY25M	.185	7.31	1.750	MS3367-1	50	100	1000
TY5253M	TY253M	.187	11.6	3.000	MS3367-7	50	100	1000
TY528M	TY28M	.187	14.20	4.000	MS3367-2	50	100	1000
TY5272M	TY272M	.270	8.75	2.000	-	120	50	500
TY527M [†]	TY27M [†]	.270	13.40	3.500	MS3367-3	120	50	500
TY5275M	TY275M	.270	18.00	5.000	-	120	50	500
TY5277M	TY277M	.270	24.30	7.000	-	120	50	500
TY529M	TY29M	.270	30.00	9.000	MS3367-6	120	50	500
TY53510M [†]	-	.320	35.00	10.000	-	175	50	-
TY54513M [†]	-	.320	45.00	13.000	-	175	50	-

Cable ties made from natural nylon 6/6 are excellent performers in most applications. Nylon 6/6 is recommended for use in temperatures ranging from 185°F to -40°F.

[†] Recognized Models.

• UL Listed Natural 6/6 Nylon Cable Ties are suitable for use in air handling spaces in accordance with Section 300-22 (C) & (D) of the National Electrical Code.

Nylon 6/6 Weather Resistant

Std. Cat. No.	Bulk Cat. No.	Body Width (in.)	Length (in.)	Max. Wire Bundle Dia. (in.)	Military Standard Part No.	Tensile Strength (lbs.)	Std. Pkg.	Bulk Pkg.
TY523MX	TY23MX	.093	3.62	.625	MS3367-4	18	100	1000
TY52315MX	TYB2315MX	.092	7.00	1.500	-	18	100	1000
TY5232MX	TY232MX	.086	8.00	2.000	-	18	100	1000
TY5234MX	TY234MX	.086	14.00	4.000	-	18	100	1000
TY524MX	TY24MX	.140	5.50	1.125	MS3367-5	30	100	1000
TY5242MX	TY242MX	.140	8.19	2.000	-	30	100	1000
TY526MX	TY26MX	.140	11.10	3.000	-	40	100	1000
TY5244MX	TY244MX	.140	14.50	4.000	-	30	100	1000
TY525MX	TY25MX	.185	7.31	1.750	MS3367-1	50	100	1000
TY5253MX	TY253MX	.187	11.6	3.000	MS3367-7	50	100	1000
TY528MX	TY28MX	.187	14.20	4.000	MS3367-2	50	100	1000
TY5272MX [†]	TY272MX	.270	8.75	2.000	-	120	50	500
TY527MX [†]	TY27MX [†]	.270	13.40	3.500	MS3367-3	120	50	500
TY5275MX	TY275MX	.270	18.00	5.000	-	120	50	500
TY5277MX	TY277MX	.270	24.30	7.000	-	120	50	500
TY529MX	TY29MX [*]	.270	30.00	9.000	MS3367-6	120	50	500
TY53510MX [†]	-	.320	35.00	10.000	-	175	50	-
TY54513MX [†]	-	.320	45.00	13.000	-	175	50	-

* For military compliance of weather resistant black 120 lbs. ties, replace suffix X with O (ie. TY27M-O).

[†] Not Listed or Recognized Models.

Ty-Rap®/Ty-Fast®

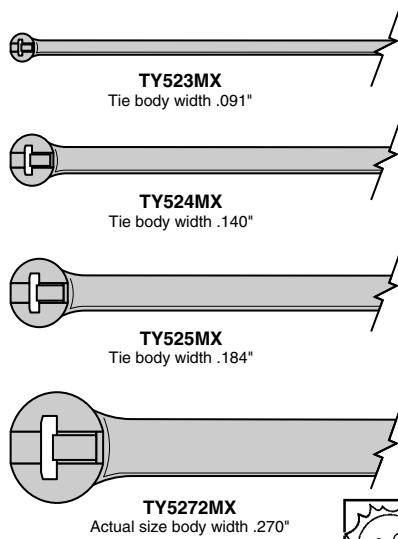

ULTRAVIOLET
RESISTANT

The MX series cable ties are recommended for outdoor use. The addition of carbon black provides good ultraviolet resistance and prolongs the useful life of the cable tie.



Ty-Rap® Nylon 6/6 Cable Tie – Color Assortment

Std. Cat. No.	Body Width (in.)	Length (in.)	Max. Wire Bundle Dia. (in.)	Military Standard Part No.	Tensile Strength (lbs.)	Std. Pkg.
696-41853	0.184	7.31	1.75	-	50	10

Cable ties are same size as TY525M shown above. 10 ties in each color are packaged. 100 total cable ties per package.

Thomas & Betts

Ty-Rap[®] Cable Ties

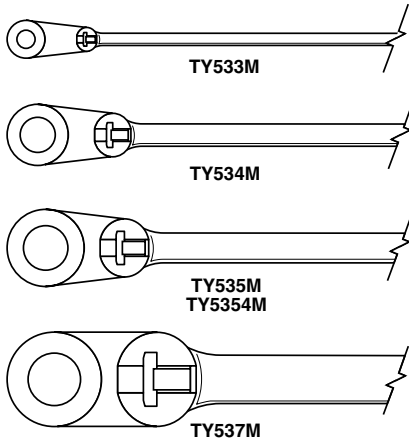

Ty-Rap[®] Mounting Head Cable Ties

Std. Cat. No.	Bulk Cat. No.	Body Width (in.)	Length (in.)	Max. Wire Bundle Dia. (in.)	Mounting Hole	Tensile Strength (lbs.)	Std. Pkg.	Bulk Pkg.
TY533M	TY33M	.091	4.00	.625	#4	18	100	1000
TY534M	TY34M	.140	6.00	1.125	#8	40	100	1000
TY535M	TY35M	.184	7.80	1.750	#10	50	100	1000
TY5354M	TY354M	.184	14.60	4.000	#10	50	100	1000
TY1435M	-	.189	7.8	1.77	.248	50	-	1000
TY635M	-	.189	7.8	1.77	.138	50	-	1000
TYF535M	TYF35M	.189	7.24	1.77	.138	50	100	1000
TY537M	TY37M	.301	13.90	3.500	¼	120	50	500

Cable ties made from natural nylon 6/6 are excellent performers in most applications. Nylon 6/6 is recommended for use in temperatures ranging from 185°F to -40°F.

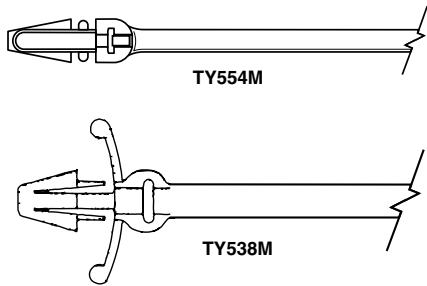

Ty-Rap[®] Push Mount Cable Ties

For use in 3/16" and 1/4" pre-drilled holes. Thickness panel .094 max. (TY554M)
Range .04 - .156 (TY538M)

Std. Cat. No.	Bulk Cat. No.	Body Width (in.)	Length (in.)	Max. Wire Bundle Dia. (in.)	Mounting Hole	Tensile Strength (lbs.)	Std. Pkg.	Bulk Pkg.
TY554M	TY54M	.140	5.96	1.125	3/16	40	100	1000
TY538M	TY38M	.184	7.80	1.750	¼	50	100	1000

Cable ties made from natural nylon 6/6 are excellent performers in most applications. Nylon 6/6 is recommended for use in temperatures ranging from 185°F to -40°F.

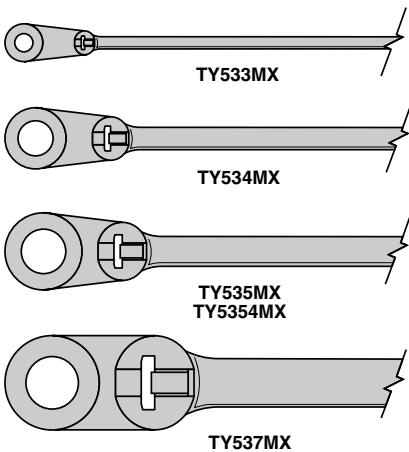

Nylon 6/6 Weather Resistant

Std. Cat. No.	Bulk Cat. No.	Body Width (in.)	Length (in.)	Max. Wire Bundle Dia. (in.)	Mounting Hole	Tensile Strength (lbs.)	Std. Pkg.	Bulk Pkg.
TY533MX	TY33MX	.091	4.00	.625	#4	18	100	1000
TY534MX	TY34MX	.140	6.00	1.125	#8	40	100	1000
TY535MX	TY35MX	.184	7.80	1.750	#10	50	100	1000
TY5354MX	TY354MX	.184	14.60	4.000	#10	50	100	1000
TY538MX	TY38MX	.184	7.80	1.750	¼	50	-	1000
TY537MX	TY37MX	.301	13.90	3.500	¼	120	50	500



ULTRAVIOLET
RESISTANT

The MX series cable ties are recommended for outdoor use. The addition of carbon black provides good ultraviolet resistance and prolongs the useful life of the cable tie.

How to Order Color-Coded Ty-Rap[®] Ties and Accessories

Color	Suffix No.	Color	Suffix No.
Black (outdoor)	X	Green	5
Brown	1	Blue	6
Red	2	Purple	7
Orange	3	Gray	8
Yellow	4	White	9

Natural nylon is standard. For colored Ty-Rap[®] ties, add the following suffix numbers to catalog numbers. Example: TY25M-2 would be red TY25M. (Consult customer service for ordering information.)



Ty-Rap® Cable Ties

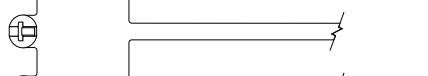
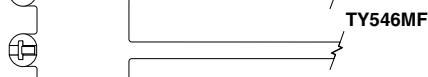
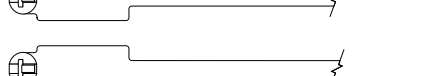
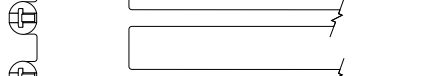
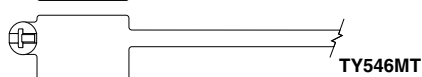
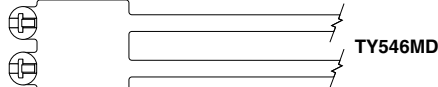
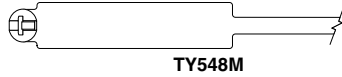
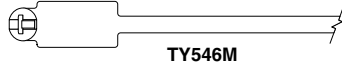
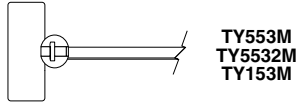
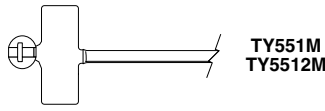

Ty-Rap® Identification Cable Ties

Std. Cat. No.	Bulk Cat. No.	Body Width (in.)	Total Length (in.)	Max. Wire Bundle Dia. (in.)	Military Standard Part No.	Marking Pad Size (in.) W x H	Tensile Strength (lbs.)	Std. Pkg.	Bulk Pkg.
TY551M	TY51M	.093	3.60	.625	MS3368-5	1 x .313	18	50	500
TY5512M	TY512M	.090	8.30	2	-	1 x .313	18	100	1000
TY553M	TY53M	.093	4.00	.625	-	.813 x .359	18	50	500
TY5532M	TY532M	.090	8.40	2	-	.813 x .359	18	100	1000
-	TY153M	.097	4.35	0.625	-	.781 x 1	18	-	500
TY546M	TY46M	.184	7.1	1.75	MS3368-1	5 x .875	50	100	1000
TY548M	TY48M	.187	14.2	4	MS3368-2	5 x 2.125	50	100	1000
TY546MD	TY46MD	.185	7.25	1.75	MS3368-3	1.172 x 1	50	50	500
TY546MT	TY46MT	.185	7.25	1.75	MS3368-4	1.210 x 1	50	100	500
TY546MF	TY46MF	.185	7.25	1.75	-	2.48 x 1	50	-	500

Self-locking Ty-Rap® identification ties are available in both single and multiple configurations. They may be marked with the special Thomas & Betts black or red marking pen which produces a permanent legend, or they can be heat stamped. Because the ties serve the dual purpose of tying and identifying, you will achieve extra economies. They can be applied with the standard Ty-Rap® tying tools used for regular ties.



Custom Heat Stamping

Thomas & Betts' Custom Heat Stamping provides an economical way to fasten and identify cable bundles. Mark nylon cable ties, identification cable ties, and identification plates to suit your application.

- 1/16", 1/8", 3/16" characters available.
- Standard Type: Gothic Capitol.
- Character sizes can be mixed from line to line on Identification cable ties.
- Alphanumeric and Sequential numbering available.
- Six digit sequential numbering available in 1/8" characters.
- Eight digit sequential numbering available in 1/16" and 3/16" characters.
- The following colors of heat stamping are available – Black, Blue, Green, Red, Yellow, Orange and White.
- Special logos and different type styles can be accommodated when camera ready artwork is provided.
- Minimum order quantity is 2500 pieces per part number and message.

Contact Technical Services for Pricing, Availability, Quotation and Order Entry **888-862-3289.**

Thomas & Betts

Ty-Rap® Cable Ties

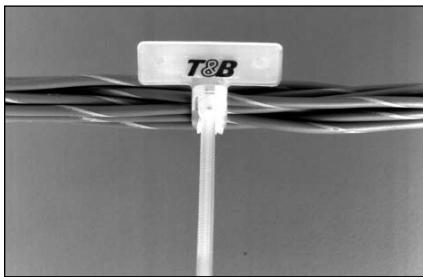
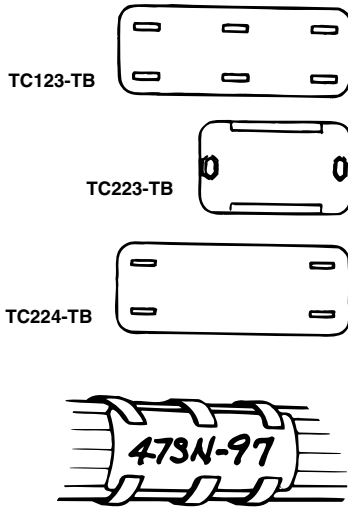

Snaps onto the head of a conventional cable tie to convert it to an identification tie.

- When snapped onto the tie head, the tag is conveniently held in place until it is permanently fastened.
- Offers maximized inventory control because the I.D. tag will accommodate different tie lengths and materials.



Identification Plates

Bulk Cat. No.	Width (in.)	Length (in.)	Thickness (in.)	Max. Cable Tie Width (in.)	Bulk Pkg.
TC123-TB	.75	1.25	.010	.190	1000
TC124-TB	.75	1.50	.010	.190	1000
TC125-TB	.75	1.75	.010	.190	1000
TC126-TB	.75	2.00	.010	.190	1000
TC128-TB	.75	2.50	.010	.190	1000
TC223-TB	.75	1½	.015	.190	1000
TCZ223	.75	1½	.015	.190	1000
TC224-TB	.75	1.28	.015	.190	1000
TC225-TB	.75	1.75	.015	.190	1000
TC226-TB	.75	2.00	.015	.190	1000
TC228-TB	.75	2.50	.015	.190	1000

Ranging in length from 1¼" to 2½", the identification plates are secured to the cable with Ty-Rap® ties. They are composed of .010" and .015"-thick nylon, and have a surface which can be marked easily. Thomas & Betts offers custom heat stamping of your plates at the factory. Other materials are available. Contact customer service. Tefzel® is a registered trademark of Dupont.

Snap-On Identification Marker Tag

- Allows marking and bundling to be done in one operation.
- The marking can be made with a Thomas & Betts permanent marking pen (black or red); catalog numbers: WT163M-1 (black), WT163M-3 (red).
- The identification tags are sold separately and can be conveniently snapped on the cable ties at the assembly location just before being installed on the bundle.

Std. Cat. No.	Bulk Cat. No.	Description	Marking Pad Size (in.) W x H	Std. Pkg.	Bulk Pkg.
TC523	TC23	Snaps onto the heads of all miniature 18 lbs. series cable ties	1" x .35"	100	1000
TC524	TC24	Snaps on to the heads of all intermediate 30 & 40 lbs. series cable ties	1" x .50"	100	1000
TC525	TC25	Snaps onto the heads of all standard 50 lbs. series cable ties	1" x .50"	100	1000

Note: Made of natural nylon 6/6.

Ty-Rap® Marking Pens

Cat. No.	Color Ink	Std. Pkg.
WT163M-1	Black	1
WT163M-3	Red	1

- Permanent, fine point.

Striped Ties

Bulk Cat. No.	Width (in.)	Length (in.)	Max. Wire Bundle Dia.	Tensile Strength	Bulk Pkg.
650-40587-1	0.091	3.62	0.625	18	-

Thomas & Betts

Ty-Rap®/Ty-Fast®

Ty-Rap® Cable Ties

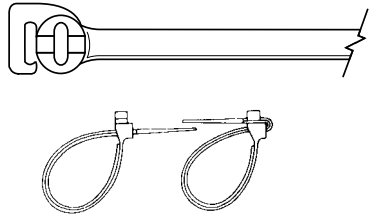

This Ty-Rap® brand cable tie lets you secure wire bundles up to 1¼ inches in diameter to all masonry surfaces. It is equipped with a masonry plug which is driven into the drilled hole. Once installed, the tail is looped through the head to provide a neat, safe, low-profile installation. It is made of black, weather-resistant nylon.

Reusable Ty-Rap® Cable Ties

Cat. No.	Body Width (in.)	Length (in.)	Bundle Dia. (in.)	Tensile Strength	Std. Pkg.
TYR505	.184	7.50	1.75	50	100
TYR508	.184	14.30	4.00	50	100

Cable ties made from natural nylon 6/6 are excellent performers in most applications. Nylon 6/6 is recommended for use in temperatures ranging from 185°F to -40°F.

Plug-Ty® Cable Tie for Masonry Surfaces

Cat. No.	Body Width (in.)	Max. Wire Bundle Dia. (in.)	Masonry Hole Size	Pullout Force	Std. Pkg.
TY544MX	.184	1.75	¼	25	50

Drive-Ty® Cable Tie

Cat. No.	Body Width (in.)	Max. Wire Bundle Dia. (in.)	Pullout Force	Std. Pkg.
TY545MX	.184	1.5	50	50



The Drive-Ty® cable tie gives you a fast, safe means of securing cables to wood surfaces.

Universal Button Head Cable Tie

Std. Cat. No.	Bulk Cat. No.	Body Width (in.)	Length (in.)	Max. Wire Bundle Dia. (in.)	Hole Size	Tensile Strength	Std. Pkg.	Bulk Pkg.
TY541M	TY41M	.225	9.60	2.37	.32-.68	65	50	1000
650-41600	—	.225	10.25	2.5	.32-.68	65	500	1000
696-41848	—	.225	12.5	3	.32-.68	65	500	1000

Note: Loop tie through hole in frame, around electrical, hydraulic, or air hoses to be clamped, and through head. Tighten and cut off with Ty-Rap tool. Visually looks like a rivet.



- One-piece design, fast and convenient to use.
- Lowers your installed cost.
- Clamping range of ¼ to 2½ inches reduces your inventory – one clamp replaces many.
- Visually attractive – head resembles rivet.
- Locking grooves maintain tight grip.

Ty-Rap®/Ty-Fast®

Ty-Rap®

Cable Ties for Special Environments

Cable Ties – Material Selection Ordering Guide

Thomas & Betts offers Ty-Rap® cable ties and accessories in a wide variety of materials, each suited for specific environments. The purpose of this document is to assist you in choosing the best material for your particular application. The effects of weathering, flame, chemicals, extreme temperatures, and radiation on the different materials are clearly presented in the following tables to simplify this process. Once you have determined the most suitable material, you can choose from the wide variety of Ty-Rap® cable ties, identification ties, mounting bases, lashing ties, etc., offered by Thomas & Betts.

General

How to use Table 1:

Table 1 simplifies the material selection process by giving the relative performance ratings of the materials offered by Thomas & Betts. For example, if your application is in an extremely cold environment, four materials will answer your need: Tefzel®, nylon 12, Halar® +, and stainless steel. Then, cost may be your next most important criteria, so out of those four options, nylon 12 would be the most cost effective. However, if tensile strength is important, then stainless steel would be the better choice.

Refer to tables 2 and 3 for more detailed information regarding

physical properties of the materials and chemical resistance of the materials respectively.

It is extremely difficult to provide data on all the possible combinations or conditions that can occur. This information is based on data provided by the manufacturers of the specific materials listed and is provided only as a general guide. No specific recommendation is intended. As each application may differ, cable tie samples should be tested in the intended application by the user to determine suitability.

* - Tefzel® is the trademark of E. I. DuPont deNumours and Compant.

+ - Halar® is the trademark of Solvay Solexius.

Available Materials

5 = Most Suitable 1 = Least Suitable

	Natural 66 Nylon	Weather Resistant 66 Nylon	Heat Stabilized Natural 66 Nylon	Flame Retardant 66 Nylon	Weather Resistant Nylon 12	Weather Resistant Polypropylene	Tefzel®	Halar®	Stainless Steel	Weatherable Acetal
Ultraviolet Resistance	1	4	1	1	4	4	5	5	5	4
Radiation Resistance	1	1	1	1	1	1	4	4	5	1
Low Temperature	3	3	3	2	4	3	4	4	5	4
Hig Temperature	3	3	4	3	2	2	4	4	5	2
Flammability	3	3	3	4	1	1	4	4	5	1
Tensile Strength	3	3	3	3	2	1	3	3	5	2
Relative Cost	Low	Low	Low	Med	Med	Low	High	High	High	High
Chemical Resistance	See Table 3									



Ty-Rap®

Cable Ties for Special Environments

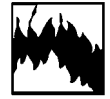
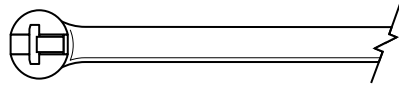

FLAMMABILITY

For additional specifications see pages J19-J20.

Flame Retardant Ties

Bulk Cat. No.	Body Width (in.)	Length (in.)	Max. Wire Bundle Dia. (in.)	Marking Pad Size (in.) W x H	Tensile Strength (lbs.)	Bulk Pkg.
TY23MFR	.091	3.62	.625	NA	18	1000
TY232MFR	.091	8.00	2.00	NA	18	1000
TY24MFR	.140	5.50	1.125	NA	40	1000
TY25MFR	.184	7.31	1.75	NA	50	1000
TY28MFR	.184	14.20	4.00	NA	50	1000
TY272MFR†	.301	8.00	2.00	NA	120	500
TY27MFR	.301	13.20	3.50	NA	120	500
TY53MFR	.091	4.00	.625	.813 x .359	18	500
TY153MFR	.097	4.35	.625	.781 x 1	18	500

This material meets U.L. 94V-0 flammability rating.

† Not Recognized Model.

Color – White



WEATHER RESISTANT



ULTRAVIOLET RESISTANT

Nylon 12 Ties

Std. Cat. No.	Bulk Cat. No.	Body Width (in.)	Length (in.)	Max. Wire Bundle Dia. (in.)	Tensile Strength (lbs.)	Std. Pkg.	Bulk Pkg.
TC525MX	TYC25MX	.184	7.31	1.75	35	100	1000
-	TYC28MX	.184	14.20	4.00	35	-	1000
-	TYC272MX	.270	8.00	2.00	85	-	500
-	TYC27MX	.270	13.20	3.50	85	-	500
-	TYC29MX	.300	30.00	9.00	85	-	500

This material provides very good resistance to ultraviolet light and chemical exposure. Nylon 12 is a lower, moisture-absorbing material than 6/6 nylon and the effect of water on properties is much less.

Color – Black

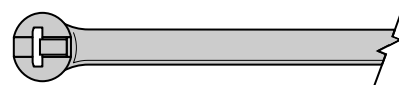

HIGH TEMPERATURE

Heat-Stabilized Ties

Bulk Cat. No.	Body Width (in.)	Length (in.)	Max. Wire Bundle Dia. (in.)	Tensile Strength (lbs.)	Bulk Pkg.
TYH24M	.140	5.50	1.125	30	1000
TYH25M	.184	7.31	1.75	50	1000
TYH28M	.184	14.20	4.00	50	1000
TYH27M	.270	13.20	3.50	120	500
TYH26M	.140	11.10	3.00	30	1000
TYH212M					
TYH29M	.301	30.00	9.00	120	500
TYH232M	.091	8.00	2.00	18	1000
TYH242M	.140	8.19	2.00	30	1000
TYH23M	.091	3.62	.625	18	1000
TYH253M	.184	11.40	3.00	50	1000

Heat-stabilized ties are recommended for higher continuous temperature use (221°F/105°C).

Material meets ASTM D4066 PA121.

Color – Green Tint

Thomas & Betts

Ty-Rap®

Cable Ties for Special Applications



ULTRAVIOLET RESISTANT



CHEMICAL RESISTANT

Many factors combine to determine the useful life of a cable tie, but none is as important as chemical exposure. Polypropylene cable ties are ideally suited for chemical environments.

Weather-Resistant Polypropylene Ties

Bulk Cat. No.	Body Width (in.)	Length (in.)	Max. Wire Bundle Dia. (in.)	Tensile Strength (lbs.)	Bulk Pkg.
TYP25MX	.184	7.31	1.75	30	1000
TYP28MX	.184	14.20	4.00	30	1000
TYP27MX	.270	13.20	3.50	60	500

Color – Black

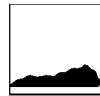

LOW SMOKE

Ty-Rap® cable ties, made of halar®, are designed for use in air-handling spaces. Due to its UL 94V-0 flammability rating and low-smoke density characteristics, Halar® material is most suitable in applications where flame resistance and smoke generation is a concern.

Halar®* Cable Ties

Std. Cat. No.	Bulk Cat. No.	Body Width (in.)	Length (in.)	Max. Wire Bundle Dia. (in.)	Tensile Strength (lbs.)	Std. Pkg.	Bulk Pkg.
TYV523M	–	.091	3.62	.625	18	100	100
TYV525M	TYV25M	.184	7.31	1.750	50	100	1000

* Solvay Solexis, Inc. registered trademark.

Color – Maroon

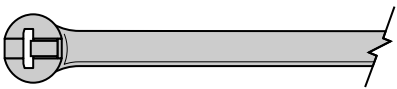

ULTRAVIOLET RESISTANT



RADIATION

Tefzel® cable ties offer high-radiation resistance and temperature stability to 302°F. Also, Tefzel® provides excellent resistance to ultraviolet light and meets U.L. flammability rating 94V-0.

TEFZEL®* Cable Ties

Std. Cat. No.	Bulk Cat. No.	Body Width (in.)	Length (in.)	Max. Wire Bundle Dia. (in.)	Tensile Strength (lbs.)	Std. Pkg.	Bulk Pkg.
TYZ523M	TYZ23M	.091	3.62	.625	18	100	1000
TYZ525M	TYZ25M	.184	7.31	1.750	50	100	1000
TYZ528M	TYZ28M	.184	14.19	4.000	50	100	1000
TYZ527M	TYZ27M	.301	13.38	3.500	120	50	500

* DuPont registered trademark.

Color – Aqua



Ty-Rap®/Ty-Fast®



Ty-Rap®

Stainless Steel Cable Ties and Accessories

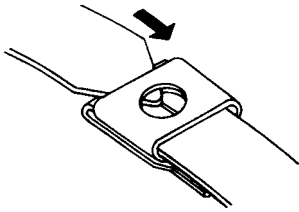

After wrapping the object to be tied, insert the free end of the tie through the buckle and into the tool.

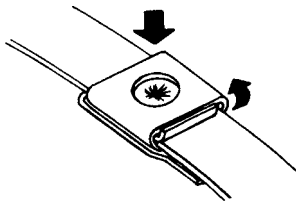

Squeeze the handle of the tool to create the dual lock and cut off the tail. The cable tie forms a low-profile dual lock.



- The tail is formed into a fold lock behind the buckle.
- The tool forces a dimple in the band into a hole in the buckle.

Dual Lock

Thomas & Betts has a complete package of stainless steel cable ties and accessories that are easy to apply and superior in quality. These products have been designed for tying, lashing and identification applications in demanding environments such as boiler rooms, chemical plants, refineries, pulp/paper mills, shipyards and offshore oil platforms. They are made of a variety of high-quality stainless steel materials which offer excellent corrosion resistance, high temperature and durability characteristics. There is also a variety of high-quality installation and identification tools to complete your cable tie accessory needs.

For cable bundling, I.D. tags and other general bundling applications – especially in hazardous environments – Thomas & Betts Stainless Steel Cable Ties provide a strong, safe, permanent installation with a unique, dual lock.

The Type 304 stainless steel ties are completely fireproof – no toxic fumes, no sagging cables. They are extremely resistant to corrosion and UV light, with the ability to withstand the harshest temperature extremes. Yet they are surprisingly economical.

The low-profile ties are fast and easy to apply. A quick squeeze of the installation tool forms two strong locks – a dimple lock and a fold lock.

Their two-piece configuration adds to its versatility. Available in standard lengths to wrap bundle diameters from 1 to 10 inches, Thomas & Betts Stainless Steel Cable Ties can be supplied in other lengths on special order.

Low-profile Thomas & Betts Stainless Steel Ties are fireproof and resist corrosion, UV light and extreme weather conditions for safe, permanent cable bundling.

Installation Hand Tool

The installation hand tool is a lightweight, pocket size hand tool which quickly and easily applies the stainless steel cable ties.

To use, simply separate the pull-up handle from the body, push the release lever down and insert the clamp tail as far as possible. Squeeze the pull-up handle until the band is tight. Finally, move the pull-up handle to the locking/cut-off position by moving it away from the body as far as it will go. Then squeeze to form the dual lock and cut off the excess tail.

Catalog Number System

TYS	6	280	C
CABLE TIE TYPE	LENGTH INCHES	WIDTH	COATED
SS = Two-piece solid stainless steel cable tie Type 304	6 = 6.0" long	280 = .280" wide	C = Nylon 11 coated _ = uncoated
TYS = Multi-lock stainless steel cable tie Type 316			
SSR = Reusable stainless steel cable tie Type 200/300			
SSH = Heavy duty stainless steel clamp Type 201			

Thomas & Betts

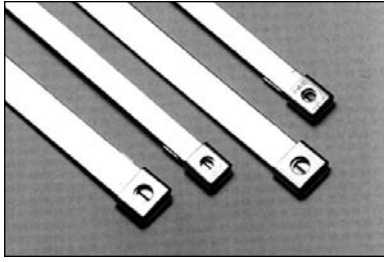
Ty-Rap®**Stainless Steel Cable Ties and Accessories**

Strong, safe, low-profile permanent single wrap ties with a unique, dual lock.



A lightweight, pocket size hand tool which quickly and easily applies standard-size stainless steel ties.

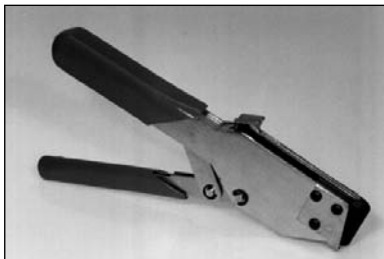

Same features as the Standard Tie Installation Tool but used to apply mini-size stainless steel ties.

Standard Stainless Steel Cable Ties

Cat. No.	For Bundle Diameter of		Tensile Strength lbs.	Width		Length		Weight	
	in.	mm		in.	mm	in.	mm	lbs.	kg.
SS10-250	2	51	200	.25	6.35	10.0	254	1.1	6.50
SS17-250	4	101	200	.25	6.35	16.5	419	1.8	0.82
SS23-250	6	152	200	.25	6.35	22.5	572	2.5	1.14
SS29-250	8	203	200	.25	6.35	29.0	737	3.2	1.45
SS35-250	10	254	200	.25	6.35	35.0	889	3.8	1.73

Mini Stainless Steel Cable Ties

SS7-180	1	25	100	.177	4.5	6.5	165	0.7	0.32
SS10-180	2	51	100	.177	4.5	10.0	254	0.9	0.41
SS16-180	4	102	100	.177	4.5	16.0	406	1.4	0.64
SS23-180	6	152	100	.177	4.5	22.5	572	1.846	–
SS29-180	8	203	100	.177	4.5	29.0	737	2.346	–

304 Stainless Steel

Packaging Quantity: 100/bag

.015" (.38mm) Thickness

Note: Other lengths available on special request.

Add suffix **-316** for 316 Stainless Steel.

Standard Tie Installation Tool

Cat. No.	Description	Weight	
		lbs.	kg.
WTA250	Hand tool to apply standard stainless steel cable ties; easy to use tool applies tension, locks tie with the dual lock, and cuts off band flush with top surface of buckle	1.17	0.53

Packaging Quantity: 1/box

Mini Tie Installation Tool

Cat. No.	Description	Weight	
		lbs.	kg.
WTA290	Hand tool to apply standard stainless steel cable ties; easy to use tool applies tension, locks tie with the dual lock, and cuts off band flush with top surface of buckle	1.17	0.53

Packaging Quantity: 1/box

Note: Mini Installation Tools will only apply mini-size ties.

Ty-Rap®/Ty-Fast®

Thomas & Betts

Ty-Rap®

Multi-Lok Stainless Steel Self-Locking Cable Ties

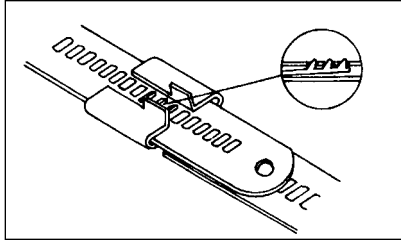
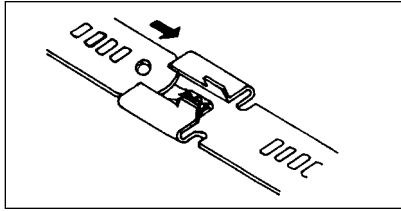

As the free end of the Multi-Lok tie passes through the buckle, three separate teeth (four teeth in the 12mm Multi-Lok) mesh with corresponding slots in the band automatically locking the tie as it is being tensioned. Self-locking Multi-Lok Ties feature an extremely strong, unique multiple locking system.

Fire hazards ... corrosive environments ... temperature extremes ... for many cable bundling applications, plastic ties are simply inadequate—or even dangerous.

That's why we developed stainless steel Multi-Lok Ties. Unaffected by fire, UV or extreme temperatures, corrosion-resistant Multi-Lok Ties provide a safe, strong, worry-free hold. Quickly and easily applied by hand or with the Thomas & Betts Cable Tie Tensioner or Tensioning hook, Multi-

Lok Ties feature a unique, self-locking, multiple-locking system that holds in excess of 200 lbs.

Multi-Lok Ties are manufactured from Type 316 stainless steel and are available either uncoated or coated with halogen-free, non-toxic black Nylon 11. This weather-resistant coating is unaffected by UV sunlight. This adds resistance to corrosion, chemicals, and weathering. Ties are available in two widths and various lengths.



Type 316 Stainless Steel—Nylon 11 Coated

Cat. No.	Tensile Strength lbs.	Width		Length		Weight	
		in.	mm	in.	mm	lbs.	kg.
TYS6-280C	250	.276	7	6	150	.66	.30
TYS9-280C	250	.276	7	9	225	.99	.45
TYS12-280C	250	.276	7	12	300	1.32	.60
TYS18-280C	250	.276	7	18	450	1.76	.80
TYS24-280C	250	.276	7	24	610	2.64	1.20
TYS6-470C	250	.472	12	6	150	1.10	.50
TYS9-470C	250	.472	12	9	225	1.65	.75
TYS12-470C	250	.472	12	12	300	2.20	1.00
TYS18-470C	250	.472	12	18	450	2.97	1.35
TYS24-470C	250	.472	12	24	610	4.29	1.95

Packaging Quantity: 100/bag
.010" (.245mm) Thickness

Type 316 Stainless Steel—Uncoated

Cat. No.	Tensile Strength lbs.	Width		Length		Weight	
		in.	mm	in.	mm	lbs.	kg.
TYS6-280	250	.276	7	6	150	.66	.30
TYS9-280	250	.276	7	9	225	.88	.40
TYS12-280	250	.276	7	12	300	1.21	.55
TYS18-280	250	.276	7	18	450	1.98	.90
TYS24-280	250	.276	7	24	610	2.64	1.20
TYS6-470	250	.472	12	6	150	1.10	.50
TYS9-470	250	.472	12	9	225	1.65	.75
TYS12-470	250	.472	12	12	300	2.20	1.00
TYS18-470	250	.472	12	18	450	3.19	1.45
TYS24-470	250	.472	12	24	610	4.29	1.95

Packaging Quantity: 100/bag
.010" (.245mm) Thickness

Ty-Rap®/Ty-Fast®



Ty-Rap®

Reusable Stainless Steel Cable Ties

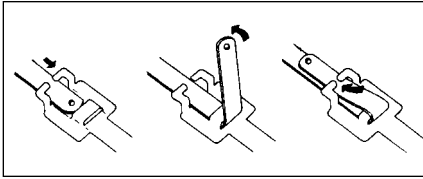

Fast, Easy Installation
 Thomas & Betts Reusable Ties are fast and easy to install. Simply pass free end of tie through buckle bridge, tension by hand or with a Thomas & Betts Tensioning Tool, bend over bridge, and secure into preformed ears.

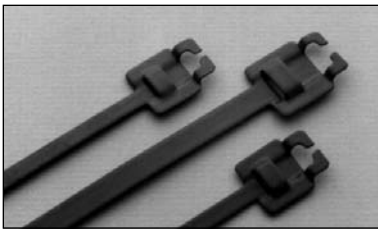

Reusable Stainless Steel Cable Ties



Cable Tie Tensioner



Tensioning Hook



Tie-It Tool WT5S

These reusable cable ties are made from high-strength, corrosion-resistant 200/300 series stainless steel, coated with a non-toxic, halogen-free, low-smoke Nylon 11.

The unique buckle design provides quick, easy application and can just as easily be unfastened for reuse. The

weather-resistant Nylon 11 coating is unaffected by UV, extremely flexible at low temperatures and protects the cables from damage or interference due to direct contact with the stainless steel. The coated product is also user-friendly on the installer's hands.

For Cable Bundling in Harsh Environments



Reusable Stainless Steel Cable Ties-Coated

Cat. No.	Tensile Strength lbs.	Width		Length		Weight	
		in.	mm	in.	mm	lbs.	kg.
SSR6-250C	75	¼	6.35	6	152	1.4	.6
SSR9-250C	75	¼	6.35	9	229	1.8	.8
SSR12-250C	75	¼	6.35	12	305	2.1	1.0
SSR18-250C	75	¼	6.35	18	457	3.0	1.4
SSR24-250C	75	¼	6.35	24	610	3.7	1.7
SSR6-375C	100	¾	9.53	6	152	1.8	.8
SSR9-375C	100	¾	9.53	9	229	2.5	1.1
SSR12-375C	100	¾	9.53	12	305	3.1	1.4
SSR18-375C	100	¾	9.53	18	457	4.4	2.0
SSR24-375C	100	¾	9.53	24	610	6.6	3.0
SSR30-375C	100	¾	9.53	30	762	7.0	3.2
SSR36-375C	100	¾	9.53	36	914	8.3	3.8

Material: 200/300 Series Stainless Steel
 Packaging Quantity: 100/bag
 .015" (.38mm) Metal Thickness; .045" (1.1mm) Coated Thickness
 Nylon 11 Coating

Note: This product may be double-wrapped for additional tensile strength. For additional colors and uncoated ties, consult Thomas & Betts Customer Service for pricing and availability.

For 316 Stainless Steel, add "suffix -316" after catalog number. Consult Customer Service for availability.

Tensioning Tools

Cat. No.	Description	Weight	
		lbs.	kg.
Cable Tie Tensioner WTAE200	For tensioning Reusable Ties and Multi-Lok Ties	.6	.3
Packaging Quantity: 1/box			
Tensioning Hook WTAE201	For tensioning Reusable Ties and Multi-Lok Ties	.1	.05
Packaging Quantity: 1/box			
Tie-It Tool WT5S	For installing Multi-Lok Series Stainless Steel Ties	1.0	.45

Packaging Quantity: 1/box
 U.L. listed

Ty-Rap®/Ty-Fast®

Ty-Rap®

Stainless Steel Ties-Free-End

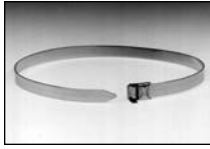

Pre-assembled Free-End Clamps provide maximum strength and durability. They may be single-wrapped or, for extra strength, double-wrapped.

Strong, durable Free-End Clamps are available in a wide range of lengths, widths, and thicknesses.

Heavy Duty Free-End Stainless Steel Clamps—Type 201

Cat. No.	Max. Dia. Once Around		Max. Dia. Twice Around		Total Length		Tensile Strength Single Wrap lbs.	Band Width		Band Thickness		Pkg. Qty.	Weight	
	in.	mm	in.	mm	in.	cm		in.	mm	in.	mm		lbs.	kg.
SSH10-250	2	50	—	—	10	25	450	¼	6.35	.020	.51	100	2.2	.99
SSH16-250	3½	88	1½	38	16	40	450	¼	6.35	.020	.51	100	3.1	1.40
SSH16-375	3½	88	1½	38	16	40	900	¾	9.53	.025	.63	100	6.2	2.80
SSH18-500	4	101	2	50	18	45	1400	½	12.70	.030	.76	100	10.5	4.80
SSH19-250	5	127	2½	63	19	48	450	¼	6.35	.020	.51	100	3.5	1.60
SSH21-625	5	127	2½	63	21	53	1700	¾	15.88	.030	.76	100	15.1	6.80
SSH24-750	6	152	3	76	24	60	2000	¾	19.05	.030	.76	50	10.9	4.90
SSH27-250	7	177	3½	88	27	68	450	¼	6.35	.020	.51	100	4.6	2.10
SSH31-500	8	203	4	101	31	78	1400	½	12.70	.030	.76	25	4.7	2.10
SSH34-250	9	228	4½	114	34	86	450	¼	6.35	.020	.51	100	5.6	2.60
SSH37-750	10	254	5	127	37	93	2000	¾	19.05	.030	.76	25	7.6	3.50
SSH44-375	12	304	6	152	44	112	900	¾	9.53	.025	.63	25	3.6	1.60
SSH50-750	14	355	7	177	50	127	2000	¾	19.05	.030	.76	25	9.7	4.40
SSH56-625	16	406	8	203	56	142	1700	¾	15.88	.030	.76	25	9.0	4.10
SSH62-750	18	457	9	228	62	157	2000	¾	19.05	.030	.76	25	11.6	5.30
SSH69-625	20	508	10	254	69	175	1700	¾	15.88	.030	.76	25	10.7	4.80

Type 201 Stainless Steel
Other Free-End Clamp sizes and metals are available on special order.

Ty-Rap®/Ty-Fast®



WTJ020

Lightweight pocket-size tool to install ¼" and ⅜" wide Free-End Clamps. It applies tension and has a built-in cutter.



WTC075

Designed to install ¼" to ⅝" wide Free-End Clamps. The lightweight, ratchet-action tool tensions, cuts and secures the buckle tab.

Installation Tools

Cat. No.	Description	Weight	
		lbs.	kg.
WTJ020	Pok-It II Tool	1.1	.5
WTC075	Bantam Tool; Three-way handle version for one-hand pistol grip or two-hand tensioning	2.6	1.2
WTC001	Heavy-Duty Clamp Tool	4.4	2.0

Packaging Quantity: 1/box



WTC001

A drop-forged tool with tensioning capability to do all Free-End Clamps.

Thomas & Betts

Ty-Rap®

Stainless Steel Ties



Mini Stainless Steel Cable Ties



Standard Stainless Steel Cable Ties

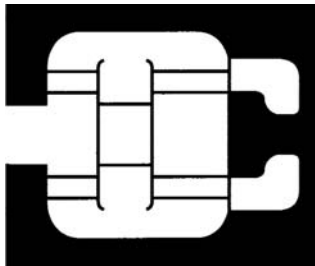

Reusable Stainless Steel Cable Ties

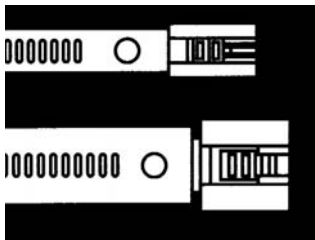

Multi-Lok Ties

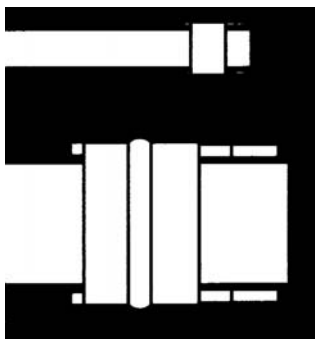

Free-End Clamps

Specifications

Cat. No.	Width		Length		Thickness		Max. Dia. Single Wrap		Max. Dia. Double Wrap	
	in.	mm	in.	mm	in.	mm	in.	mm	in.	mm
SS7-180	.177	4.50	6.5	165	.015	.38	1.7	43	(single wrap)	
SS10-180	.177	4.50	10	254	.015	.38	2.8	71	(single wrap)	
SS16-180	.177	4.50	16	406	.015	.38	4.7	119	(single wrap)	
SS23-180	6	152	100	.177	4.5	22.5	572	1.846	-	
SS29-180	8	203	100	.177	4.5	29.0	737	2.346	-	
SS10-250	¼	6.35	10	254	.015	.38	2.1	53	(single wrap)	
SS17-250	¼	6.35	16.5	419	.015	.38	4.3	109	(single wrap)	
SS23-250	¼	6.35	22.5	572	.015	.38	6.5	165	(single wrap)	
SS29-250	¼	6.35	29	737	.015	.38	8.5	215	(single wrap)	
SS35-250	¼	6.35	35	889	.015	.38	10.5	265	(single wrap)	
SSR6-250C	¼	6.35	6	152	.015	.38	1.5	38	N.A.	N.A.
SSR9-250C	¼	6.35	9	229	.015	.38	2.5	63	1.1	28
SSR12-250C	¼	6.35	12	305	.015	.38	3.4	86	1.5	38
SSR18-250C	¼	6.35	18	457	.015	.38	5.4	137	2.5	64
SSR24-250C	¼	6.35	24	610	.015	.38	7.3	185	3.5	89
SSR6-375C	⅜	9.53	6	152	.015	.38	1.5	38	N.A.	N.A.
SSR9-375C	⅜	9.53	9	229	.015	.38	2.5	63	1.1	28
SSR12-375C	⅜	9.53	12	305	.015	.38	3.4	86	1.5	38
SSR18-375C	⅜	9.53	18	457	.015	.38	5.4	137	2.5	64
SSR24-375C	⅜	9.53	24	610	.015	.38	7.3	185	3.5	89
SSR30-375C	⅜	9.53	30	762	.015	.38	9.1	231	4.4	112
SSR36-375C	⅜	9.53	36	914	.015	.38	11.0	280	5.3	135
Uncoated	Nylon 11 Coated									
TYS6-280	.28	7.00	6	152	.010	.25	1.9	48	(single wrap)	
TYS9-280	.28	7.00	9	229	.010	.25	2.8	71	(single wrap)	
TYS12-280	.28	7.00	12	305	.010	.25	3.8	96	(single wrap)	
TYS18-280	.28	7.00	18	457	.010	.25	5.7	144	(single wrap)	
TYS24-280	.28	7.00	24	610	.010	.25	7.6	193	(single wrap)	
TYS6-470	.47	12.00	6	152	.010	.25	1.9	48	(single wrap)	
TYS9-470	.47	12.00	9	229	.010	.25	2.8	71	(single wrap)	
TYS12-470	.47	12.00	12	305	.010	.25	3.8	96	(single wrap)	
TYS18-470	.47	12.00	18	457	.010	.25	5.7	144	(single wrap)	
TYS24-470	.47	12.00	24	610	.010	.25	7.6	193	(single wrap)	
SSH10-250	¼	6.35	10	250	.020	.51	2.0	50	N.A.	N.A.
SSH16-250	¼	6.35	16	400	.020	.51	3.5	88	1.5	38
SSH19-250	¼	6.35	19	480	.020	.51	5.0	127	2.5	63
SSH27-250	¼	6.35	27	680	.020	.51	7.0	177	3.5	88
SSH34-250	¼	6.35	34	860	.020	.51	9.0	228	4.5	114
SSH16-375	⅜	9.53	16	400	.025	.63	3.5	88	1.5	38
SSH44-375	⅜	9.53	44	1120	.025	.63	12.0	304	6.0	152
SSH18-500	½	12.70	18	460	.030	.76	4.0	101	2.0	50
SSH31-500	½	12.70	31	780	.030	.76	8.0	203	4.0	101
SSH21-625	⅝	15.88	21	530	.030	.76	5.0	127	2.5	63
SSH56-625	⅝	15.88	56	1420	.030	.76	16.0	406	8.0	203
SSH69-625	⅝	15.88	69	1750	.030	.76	20.0	508	10.0	254
SSH24-750	¾	19.05	24	600	.030	.76	6.0	152	3.0	76
SSH37-750	¾	19.05	37	940	.030	.76	10.0	254	5.0	127
SSH50-750	¾	19.05	50	1270	.030	.76	14.0	355	7.0	177
SSH62-750	¾	19.05	62	1570	.030	.76	18.0	457	9.0	228



Ty-Rap® Stainless Steel Ties



Specifications—continued

Cat. No.	Stainless Steel Type	Coating or Finish	Min. Loop Tensile Strength		Min. Loop Tensile Strength		Application Tools Used	General Application
			Single Wrap Lbs	Newton	Double Wrap Lbs	Newton		
SS7-180*	304	Dull to Bright	100	445	(single		WTA290	<ul style="list-style-type: none"> • Wire/Cable bundling • I.D. Tagging
SS10-180*	304		100	445	wrap			
SS16-180*	304		100	445	only)			
SS23-180*	304		100	445				
SS29-180*	304		100	445				
SS10-250*	304	Dull to Bright	200	890			WTA250	<ul style="list-style-type: none"> • Wire/Cable bundling • I.D. Tagging
SS17-250*	304		200	890	(single			
SS23-250*	304		200	890	wrap			
SS29-250*	304		200	890	only)			
SS35-250*	304		200	890				
SSR6-250C	200/300		75	334	300	1334		
SSR9-250C	200/300		75	334	300	1334		
SSR12-250C	200/300		75	334	300	1334		• Reusable
SSR18-250C	200/300	Nylon 11 Coated	75	334	300	1334		• Cable bundling
SSR24-250C	200/300	(Uncoated or other	75	334	300	1334		• Oil Rigs
SSR6-375C	200/300	colors available on	100	445	500	2224	WTAE200	• Tele-Communica-
SSR9-375C	200/300	special order)	100	445	500	2224	WTAE201	tions towers
SSR12-375C	200/300		100	445	500	2224	WTC075	• Hazardous and
SSR18-375C	200/300		100	445	500	2224		corrosive environ-
SSR24-375C	200/300		100	445	500	2224		ments
SSR30-375C	200/300		100	445	500	2224		
SSR36-375C	200/300		100	445	500	2224		
Uncoated	Nylon 11 Coated							
TYS6-280	TYS6-280C		250	1112				
TYS9-280	TYS9-280C		250	1112				
TYS12-280	TYS12-280C		250	1112				
TYS18-280	TYS18-280C		250	1112	(single		WTAE200	• Self-locking
TYS24-280	TYS24-280C	Uncoated or	250	1112	wrap			
TYS6-470	TYS6-470C	Nylon 11	250	1112			WTAE201	• Cable bundling
TYS9-470	TYS9-470C	Coated Black	250	1112	only)			
TYS12-470	TYS12-470C		250	1112			WTC075	• Hazardous and
TYS18-470	TYS18-470C		250	1112				
TYS24-470	TYS24-470C		250	1112				
			250	1112				
SSH10-250			450	2002	1200	5338		
SSH16-250			450	2002	1200	5338		
SSH19-250		Bright	450	2002	1200	5338	WTC001	• Indus. hoses
SSH27-250			450	2002	1200	5338	WTC075	• Cable bundling
SSH34-250			450	2002	1200	5338	WTJ020	• Hi-strength
SSH16-375			900	4003	2400	10675		
SSH44-375			900	4003	2400	10675		
SSH18-500			1400	6227	3300	14678		
SSH31-500			1400	6227	3300	14678	WTC001	
SSH21-625			1700	7562	4000	17792	WTC075	
SSH56-625			1700	7562	4000	17792		
SSH69-625			1700	7562	4000	17792		
SSH24-750			2000	8896	5000	22240		
SSH37-750			2000	8896	5000	22240	WTC001	
SSH50-750			2000	8896	5000	22240		
SSH62-750			2000	8896	5000	22240		

Thomas & Betts Stainless Steel Cable Ties have passed a variety of mechanical, environmental, and electrical tests. Other data can be made available upon request.

*S.S. series also available in (316) Stainless.



Ty-Rap®

Stainless Steel Cable Ties



Stainless steel cable ties have been designed for high-temperature applications as in boiler rooms, and for use in areas of harsh, corrosive environments such as shipyards and off-shore oil platforms. They are made of type 316 stainless steel, and rated at 200 pound tensile strength. Smooth edges protect both the cable insulation and the installer.



WT3S

Stainless Steel Cable Ties

Cat. No.	Body Width (in.)	Length (in.)	Max. Wire Bundle Dia. (in.)	Tensile Strength (lbs.)	Std. Pkg.
TYS8	.310	10.65	2	200	100
TYS14	.310	14.65	4	200	50
TYS22	.310	22.65	6	200	50
TYS28	.310	28.65	8	200	50

Note: Use WT3S Tool for tensioning and cutoff.
 • Cannot be coated with any covering material.

Stainless Steel Strap on a Reel

Cat. No.	Description	Body Width (in.)	Tensile Strength (lbs.)	Std. Pkg.
TYS1000	1000 foot reel of strap	.310	200	1

Stainless steel ties of virtually any length can be produced from the 1000 foot reel in combination with the matching head.
 Note: Use WT3S tool for tensioning and cutoff.

Stainless Steel Locking Heads

Cat. No.	Description	Std. Pkg.
TYS5200H	Heads only for stainless steel strap	50

Stainless Steel Mounting Base

Cat. No.	Description	Std. Pkg.
TCS25	Mounting base for stainless steel ties	50

Ty-Rap® Stainless Steel Tool

Cat. No.	Description	Std. Pkg.	Wt. Each
WT3S	Stainless steel cable tie installing tool.	1	8 oz.

Ty-Rap®/Ty-Fast®

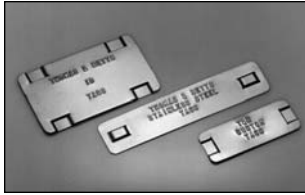
Ty-Rap®**Customized Embossed Tags Stainless Steel Tape Embossing System**

Identify your cable bundles with permanent, Type 304 stainless steel imprinted tags applied with stainless steel cable ties. After imprinting the tags, merely slip a tie through slots in the tag and fasten with the installation tool.

- Works with 1/4" wide ties.

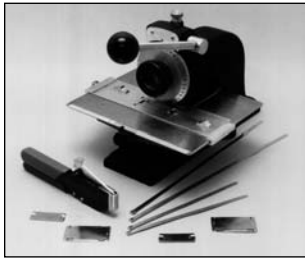

For imprinting Thomas & Betts stainless steel I.D. tags. Includes special tag holder which provides quick, accurate positioning of tag. Comes with a 3/8" character imprinting wheel, standard (no substitutions allowed).



After making your tag, apply with stainless steel cable ties.

I.D. Tagging System

Cat. No.	Width		Length		Weight	
	in.	mm	in.	mm	lbs.	kg.
SSID100	.75	19.05	2.0	51	0.5	.22
SSID101	1.50	38.10	2.5	63	1.2	.55
SSID102	.75	19.05	3.5	89	0.8	.36

304 Stainless Steel

Packaging Quantity: 100/box

.015" (.254mm) Thickness

Note: Customized pre-embossed tags are available. Please consult Technical Service for details.

Add suffix (316) for 316 Stainless Steel.

I.D. Tag Imprinter

Cat. No.	Description	Weight	
		lbs.	kg.
WTID200	I.D. Tag Imprinter	29.5	13.41
WTID281	1/8" character imprinting wheel	—	—
WTID283	3/16" character imprinting wheel	—	—
WTID290	3/8" character imprinting wheel	—	—

Packaging Quantity: 1/box

S.S. Tape Embossing System

Cat. No.	Description	Weight	
		lbs.	kg.
WTID400	Hand-held tool for embossing S.S. I.D. Tape	2.57	1.17
WTID405	Replacement S.S. tape (21' long)	.18	.01

304 Stainless Steel

Packaging Quantity: 1/box

Note: The embossing tool comes complete with two rolls of stainless steel tape.

Ty-Rap®/Ty-Fast®

Thomas & Betts

Ty-Rap®

Stainless Steel I.D. Tag

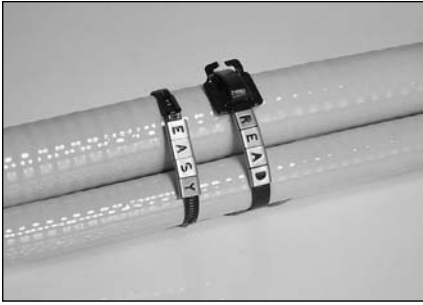

The Thomas & Betts Stainless Steel R.D. Tagging System includes a complete range of individual letters, numbers, and symbols—slip them over carriers (shown above) or strips (below) and attach to your cable or hose with a variety of Thomas & Betts Stainless Steel Cable Ties.



Thomas & Betts Stainless Steel I.D. Tag

Cat. No.	Description	Length	Width	Std. Pkg.	Wt. per 100
ER010	A	.445"	.375"	100	.31
ER011	B	.445"	.375"	100	.31
ER012	C	.445"	.375"	100	.31
ER013	D	.445"	.375"	100	.31
ER014	E	.445"	.375"	100	.31
ER015	F	.445"	.375"	100	.31
ER016	G	.445"	.375"	100	.31
ER017	H	.445"	.375"	100	.31
ER018	I	.445"	.375"	100	.31
ER019	J	.445"	.375"	100	.31
ER020	K	.445"	.375"	100	.31
ER021	L	.445"	.375"	100	.31
ER022	M	.445"	.375"	100	.31
ER023	N	.445"	.375"	100	.31
ER024	O	.445"	.375"	100	.31
ER025	P	.445"	.375"	100	.31
ER026	Q	.445"	.375"	100	.31
ER027	R	.445"	.375"	100	.31
ER028	S	.445"	.375"	100	.31
ER029	T	.445"	.375"	100	.31
ER030	U	.445"	.375"	100	.31
ER031	V	.445"	.375"	100	.31
ER032	W	.445"	.375"	100	.31
ER033	Y	.445"	.375"	100	.31
ER034	Z	.445"	.375"	100	.31
ER018	1	.445"	.375"	100	.31
ER037	2	.445"	.375"	100	.31
ER038	3	.445"	.375"	100	.31
ER039	4	.445"	.375"	100	.31
ER040	5	.445"	.375"	100	.31
ER041	6	.445"	.375"	100	.31
ER021	7	.445"	.375"	100	.31
ER042	8	.445"	.375"	100	.31
ER041	9	.445"	.375"	100	.31
ER024	0	.445"	.375"	100	.31
ER035	Minus/Hyphen	.445"	.375"	100	.31
ER036	Blank	.445"	.375"	100	.31
ER046	Plus +	.445"	.375"	100	.31
ER047	Earth	.445"	.375"	100	.31
ER048	Sine	.445"	.375"	100	.31
ER049	Slash /	.445"	.375"	100	.31

Character size .218"
Material .025 316 stainless steel

Thomas & Betts Stainless Steel I.D. Tag Strips/Carriers

Cat. No.	Description	Length	Width	Std. Pkg.	Wt. per 100
ER043	6 Character Carrier	3.64"	.38"	100	.73
ER044	10 Character Carrier	5.14"	.38"	100	1.25
ER045	16 Character Carrier	7.39"	.38"	100	1.47
ER050	Short Strip	4.25"	.38"	100	.98
ER051	Medium Strip	5.75"	.38"	100	1.33
ER052	Long Strip	8.0"	.38"	100	1.85
ER060	I.D. Tag Kit	—	—	1	—

I.D. Tag Kit contains 50 of each letter, number, symbol, carrier and strip in a handy carrying case.

Thomas & Betts

Ty-Rap®

Stainless Steel Self-Locking Ties



Stainless Steel Ties With Roller Locking Mechanism

Thomas & Betts offers a line of self-locking, stainless steel ties for indoor and outdoor use. This low profile design features an internal locking roller and spring-tension head that ensures a secure fit.

Features and Benefits

- Spring feature provides extra snug fit in applications where bundle tightness is critical.
- Internal locking roller (Average slip, within the locking mechanism at 100 lb. load is 55% lower than conventional ball lock design).
- Rounded edges and smooth surfaces for fast, safe hand installation.
- Buckle length is 38% less and height is 24% less than the conventional ball locking design.

- 5 standard lengths with custom lengths available.
- Available in two grades of stainless steel (302/304 for standard applications and 316 for extra corrosion resistance).

Ideal Applications

- High temperature locations.
- Marine environment (ship building, salt water environment).
- Harsh environment (oil rigs, wash down areas, refineries, food processing plants, auto car washers).
- Automotive plants.



How It Works

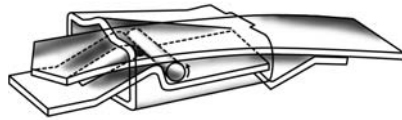

Insert the tail into the buckle. The internal locking bar rolls freely as the tie is tightened.

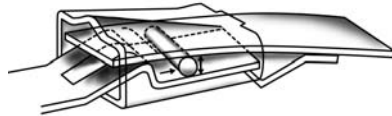

Once the proper tension is reached the tool automatically cuts off the tail. The bar then wedges into the buckle locking it tightly against both the top and bottom of the band.

Roller Locking Mechanism vs. Ball Locking Mechanism

Characteristic	Self-Lok	Ball Lock
Rating (pounds)	150	100
Buckle Length (inch)	.260	.420
Height Over Buckle (inch)	.130	.170
Avg. Slip @ 100 Lb Load (inch)	.090	.200
Normal Mode of Failure	Cont. Slip	Loss of Ball
Buckle Retention	Smooth ID	Fold Under
Tie Length	Same	Same
Material	304 or 316 SS	304 or 316 SS



Unique Spring-Tension Head Design provides extra snug fit where bundle tightness is critical.

Application Tool

DAS-250 Hand Tool
(Adjustable tension, automatic cut-off)

Spare Blades Part No. BL250S

Ty-Rap®/Ty-Fast®

Ordering Information

Cat. No.	Length		Width		Max. Bundle Dia.		Tensile		Qty./box pcs.
	in.	mm.	in.	mm.	in.	mm.	lbs.	kg.	
302/304 Grade Stainless Steel									
TS-4.6-200A	8.8	222.9	0.18	4.6	2	50.8	150	68.0	100
TS-4.6-360A	15.3	388.0	0.18	4.6	4	101.6	150	68.0	100
TS-4.6-520A	21.3	540.4	0.18	4.6	6	152.4	150	68.0	100
TS-4.6-680A	27.8	705.5	0.18	4.6	8	203.2	150	68.0	100
TS-4.6-840A	33.8	857.9	0.18	4.6	10	254.0	150	68.0	100
316 Grade Stainless Steel									
TS-4.6-200B	8.8	222.9	0.18	4.6	2	50.8	150	68.0	100
TS-4.6-360B	15.3	388.0	0.18	4.6	4	101.6	150	68.0	100
TS-4.6-520B	21.3	540.4	0.18	4.6	6	152.4	150	68.0	100
TS-4.6-680B	27.8	705.5	0.18	4.6	8	203.2	150	68.0	100
TS-4.6-840B	33.8	857.9	0.18	4.6	10	254.0	150	68.0	100

Thomas & Betts

Ty-Rap®

Stainless Steel Self-Locking Ties

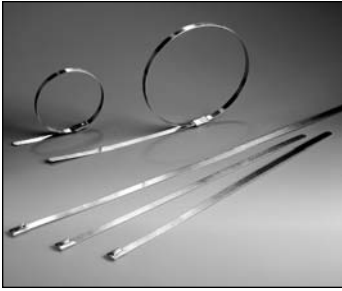

DAS-250
Preset tension tool
Automatic cut-off
Spare Blades Part No. BL 250 S

Stainless Steel Ties with Ball Locking Mechanism

Thomas and Betts introduces a range of self-locking, one-piece stainless steel ties, suitable for indoor or outdoor use.

Wide range of sizes

Six standard lengths up to 41" long will cover most applications with custom lengths available. Two widths are offered with minimum loop tensile strengths of 100 and 250 lbs. Space requirements are minimized by the low head profile – 20" maximum.

Fast, Easy Installation

Thomas & Betts stainless steel ties are self-locking, requiring no time consuming crimping or folding operations. The strong locking mechanism, incorporating a steel ball, requires a low insertion force while the strap section has rounded edges and smooth surfaces making the ties ideal for fast, safe, hand installation.

Two Materials

Two grades of stainless steel are available – 302/304 for standard applications and 316 for extra corrosion resistance. 302/304 and 316 stainless steels are non-magnetic and are ideal for high temperature applications ranging –80 °C to 538 °C.

Applications

- High temperature locations
- Marine environment (shipbuilding, salt water environment)
- Harsh environment (oil rigs, wash-down areas, refineries, food processing plants, auto car washers)
- Automotive plants

Ordering Information

Cat. No.	Length		Width		Max. Bundle Dia.		Tensile		Qty./box pcs.
	in.	mm.	in.	mm.	in.	mm.	lbs.	kg.	
302/304 Grade Stainless Steel									
LS-4.6-200A	7.9	201.0	0.18	4.6	2	51	100	45.3	100
LS-4.6-360A	14.2	360.0	0.18	4.6	4	102	100	45.3	100
LS-4.6-520A	20.5	520.0	0.18	4.6	6	152	100	45.3	100
LS-4.6-680A	26.7	679.0	0.18	4.6	8	203	100	45.3	100
LS-4.6-840A	33.0	838.0	0.18	4.6	10	254	100	45.3	100
LS-7.9-200A	7.9	201.0	0.31	7.9	3	51	250	113.3	50
LS-7.9-360A	14.2	360.0	0.31	7.9	4	102	250	113.3	50
LS-7.9-520A	20.5	520.0	0.31	7.9	6	152	250	113.3	50
LS-7.9-680A	26.7	679.0	0.31	7.9	8	203	250	113.3	50
LS-7.9-840A	33.0	838.0	0.31	7.9	10	254	250	113.3	50
LS-7.9-1010A	41.3	1050.0	0.31	7.9	12.5	318	250	113.3	50
316 Grade Stainless Steel									
LS-4.6-200B	7.9	201.0	0.18	4.6	2	51	100	45.3	100
LS-4.6-360B	14.2	360.0	0.18	4.6	4	102	100	45.3	100
LS-4.6-520B	20.5	520.0	0.18	4.6	6	152	100	45.3	100
LS-4.6-680B	26.7	679.0	0.18	4.6	8	203	100	45.3	100
LS-4.6-840B	33.0	838.0	0.18	4.6	10	254	100	45.3	100
LS-7.9-200B	7.9	201.0	0.31	7.9	3	51	250	113.3	50
LS-7.9-360B	14.2	360.0	0.31	7.9	4	102	250	113.3	50
LS-7.9-520B	20.5	520.0	0.31	7.9	6	152	250	113.3	50
LS-7.9-680B	26.7	679.0	0.31	7.9	8	203	250	113.3	50
LS-7.9-840B	33.0	838.0	0.31	7.9	10	254	250	113.3	50
LS-7.9-1010B	41.3	1050.0	0.31	7.9	12.5	318	250	113.3	50

Ty-Rap®/Ty-Fast®

Thomas & Betts

Ty-Rap® Cable Ties-DELTEC®



The Deltec® Cable Support System

Provides a strong, long-life and cost saving method of securing communication cables

The Deltec® Cable Support System is a user-friendly product designed to provide ease and flexibility in fastening communications cables to messenger strand. It is equally well suited for copper conductor cable, coaxial cable, fiber optic cable and inner duct in aerial applications.

The Deltec® system answers your aerial cable needs with innovative design and state of the art materials. This system includes weather-resistant Delrin® cable straps, marine grade locking devices, and base hanger accessories for specific applications where mounting is required.

Deltec® cable straps are available in standard lengths of 10, 13.5, 16 and 27 inches, and in convenient 50 foot reels where specific lengths need to be established by the installer in the field. Additional "standard" lengths can be established for applications where higher volumes prevail.

Advantages of the Deltec® System Include:

- Proven years of service.
- No sharp edges - craft friendly! Cable friendly!
- Ease of installation - one wrap, no re-reading of re-strap.
- Lowers installation costs.
- High tensile strength after fastening.
- Total flexibility in lengths when using reel.
- Stackable spacers accommodate all cable sizes - no need to stock multiple sizes of individual height spacers.
- Spacer designed to retain strap on each side and cradle the cable, providing restricted movement of spacer and preventing damage to cable.
- In situations where multiple cables are supported, the T&B TCP360 stackable spacer may be rotated 90 degrees and installed similar to a single cable, yet provide the same restricting features (unlike those commonly used today).
- Month and year of manufacture stamped into strap material.

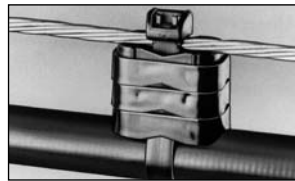

Cable Tie with Double-Locking Head

Cat. No.	Body Width	Length (in.)	Max. Wire Bundle Dia. (in.)	Tensile Strength (lbs.)	Std. Pkg.
TYD510M	.394	51.2	-	250	
TYD5135M	.500	13.5	3.5	250	25
TYD5270M	.500	27.0	8.0	250	10

The recommended maximum continuous static loading for the DELTEC® straps is 20 lbs. per strap. For best results suggested spacing is 15 inches. It is the responsibility of the user to determine whether or not their application meets our recommendation.

Note: Use WT3D Tool for tensioning and cutoff.

SPECIFICATIONS

Strap and body	Dupont DELRIN®. Offers superior resistance to sunlight, moisture, and salt environments.	Installation Range	-30°F to 150°F.
Locking Device	Marine grade corrosion-resistant silicon bronze.	Minimum Tensile Strength	250 lbs. minimum.
		Outdoor Life	Designed to last a minimum of 20 years
		Continuous Load	20 pounds

DELTEC® Strap on a Reel

Cat. No.	Description	Tensile Strength (lbs.)	Body Width	Std. Pkg.
TYD-50R	50' reel of strap	250	.500	1
696-41794	1000' reel	250	.500	2



Ty-Rap®/Ty-Fast®

Thomas & Betts

Ty-Rap® Cable Ties-DELTEC®



Locking Heads

Cat. No.	Description	Std. Pkg.
TYD-LH	Heads only for DELTEC strap	25
696-41795	1000 heads only for DELTEC strap	1000

Material: Deltec®



Modular Stackable Cable Spacers

Cat. No.	Description	Std. Pkg.
TCP5255	Modular stackable spacer for DELTEC® straps	25
TCP360	For Coaxial Cable	-

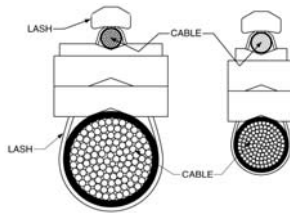

- One spacer for any cable size.
- Stackable for any desired spacing.
- Less inventory – one catalog number.
- Made of weather-resistant polypropylene.
- ½" high.



CSS-B
CSS-H

DELTEC® Base and Hanger

Cat. No.	Description	Std. Pkg.
CSS-B	Base for Deltec® strap	50
CSS-H	Hanger for Deltec® strap	50

- Made of zinc-plated steel
- Secures cables to all types of surfaces



Drop Wire Support

Cat. No.	Description	Std. Pkg.
CSS-DWS	Nylon coated steel, order by each.	25



Installation/Cutting Tool

Cat. No.	Description	Range	Std. Pkg.	Wt. Each
WT3D	Installs self-locking Ty-Rap® cable ties and Thomas & Betts 2-piece lashing ties.	.184 thru .500	1	8 oz.

Ty-Rap®/Ty-Fast®

Ty-Rap[®] Hook and Loop Fasteners



Now version available UL94V-2 rated material.
Contact Customer Service for availability and delivery.

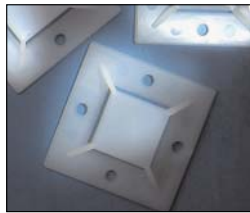
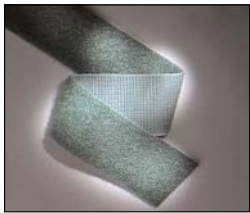
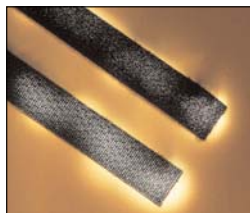
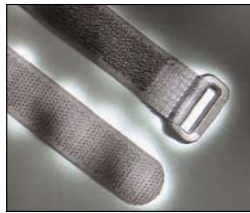
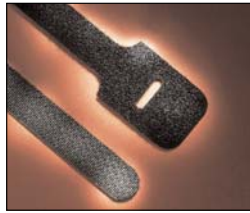

These handy ties are very easy to release and re-use, making them ideal for applications where changes are anticipated or continuous access is required.

Features

- High quality Hook & Loop Fasteners designed specifically for Thomas & Betts.

- Allows quick and convenient bundling of Category 5 & Fiber optic cables.
- Multiple colors available for identifying specific bundles.
- Sizes available to accommodate varying bundle diameters.
- Screw and adhesive mounting bases provide multiple mounting options.

FO Series Loop Ties

Ideal for wrapping pre-determined bundle diameters because of the convenient slotted head

Cat. No.	Min. Tensile Strength	Max. Bundle Dia.	Length	Width	Inner Pack Qty.
FO200-40*	40lb	2.0"	9.0"	.50	10
FO200-50*	50lb	2.0"	9.0"	.75	10
FO350-40*	40lb	3.5"	13.0"	.50	10
FO350-50*	50lb	3.5"	13.0"	.75	10

FOL Series Buckle Ties

Buckle ties provide added strength and stability because of the high performance polymer buckle.

Cat. No.	Min. Tensile Strength	Max. Bundle Dia.	Length	Width	Inner Pack Qty.
FOL300-50-0	50lb	3.0"	12.0"	.75	10
FOL500-50-0	50lb	5.0"	18.0"	.75	10

FOS Series Strip Ties

Pre-cut lengths which makes bundling a cinch.

Cat. No.	Min. Tensile Strength	Max. Bundle Dia.	Length	Inner Pack Qty.
FOS150-50-0	50lb	1.5"	6.0"	10
FOS320-50-0	50lb	3.2"	12.0"	10
FOS500-50-0	50lb	5.0"	18.0"	10

FOR Series Rolled Hook and Loop

Rolled hook and loop allows customers to conveniently cut pieces to desired lengths, eliminating waste.

Cat. No.	Min. Tensile Strength	Max. Bundle Dia.	Length	Inner Pack Qty.
FOR180-50-0	50lb	Various	180"	1

Black is standard color
* Add - "FR" for UL94V-2 rated material (after color).

Mounting Bases

Two mounting bases specifically designed for use with hook and loop fasteners

Cat. No.	Min. Tensile Strength	Max. Bundle Dia.	Length	Inner Pack Qty.
TC368	2"x 2" Screw mounted	#8	0.75"	500
TC368A	2"x 2" Adhesive mounted	#8	0.75"	500

Available in these colors: Black, Brown, Red, Orange, Yellow, Green, Blue, Grey, & White. Please consult customer service for delivery and availability.

Ty-Rap[®]/Ty-Fast[®]



Ty-Rap® Lashing Straps

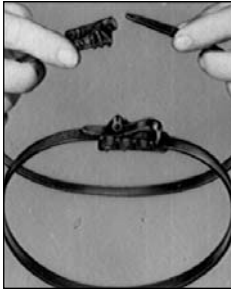

The heavy-duty lashing tie is made from weather-resistant nylon. The addition of carbon black provides good ultraviolet resistance and prolongs the useful life of the cable tie.



This lashing tie is ideally suited for chemical environments that are unsuitable for nylon. Strapping is made of black, weather-resistant polypropylene for outdoor use. Head is made of nylon 66.

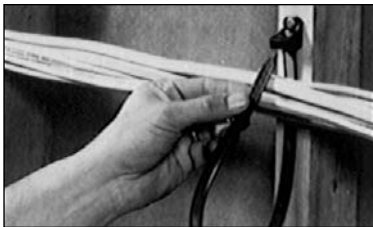

Many factors combine to determine the useful life of a cable tie and chemical exposure can be a very important consideration in certain situations. Polypropylene cable ties are ideally suited for chemical environments. It is black for outdoor use.

Heavy Duty Lashing Tie (releasable)

Std. Cat. No.	Bulk Pkg. Cat. No.	Body Width (in.)	Length (in.)	Maximum Wire Bundle Diameter (in.)	Tensile Strength (lbs.)	Std. Pkg.	Bulk Pkg.
TY5409	TY409	.500	19.00	4.75	200	25	100



Length 19"

Weather-Resistant Polypropylene Lashing Tie (releasable)

Cat. No.	Body Width (in.)	Length (in.)	Maximum Wire Bundle Diameter (in.)	Tensile Strength (lbs.)	Std. Pkg.
TY5418PX	.500	18	5	150	25
TY5424PX	.500	24	7	150	25
TY5442PX	.500	42	12	150	10
TY5460PX	.500	60	18	150	10

Weather-Resistant Polypropylene Hanger Lashing Tie (releasable)

Cat. No.	Body Width (in.)	Length (in.)	Maximum Wire Bundle Diameter (in.)	Tensile Strength (lbs.)	Std. Pkg.
TY53418PX	.500	18	5	150	25

Ty-Rap®/Ty-Fast®

Thomas & Betts

Ty-Rap® Lashing Straps



Weather-Resistant Nylon 12 Messenger Hanger Straps (releasable)

Cat. No.	Body Width (in.)	Length (in.)	Maximum Wire Bundle Diameter (in.)	Hook Material	Tensile Strength (lbs.)	Std. Pkg.
TYM5412X	.500	12	3	Bronze	200	50
TYM5418X	.500	18	5	Bronze	200	25
TYM5423X	.500	24	7	Bronze	200	25
TYM5430X	.500	30	9	Bronze	200	25
TYM5436X	.500	36	11	Bronze	200	25
TYM5412X-S	.500	12	3	Stainless Steel	200	50
TYM5418X-S	.500	18	5	Stainless Steel	200	25
TYM5423X-S	.500	24	7	Stainless Steel	200	25
TYM5430X-S	.500	30	9	Stainless Steel	200	25
TYM5436X-S	.500	36	11	Stainless Steel	200	25

The recommended, maximum continuous static loading for the nylon 12 straps is 25 lbs. per strap. For best results suggested spacing is 15 inches. It is the responsibility of the user to determine whether or not their application meets our recommendation.

- Hook will accommodate ½" dia. messenger wire.

Messenger Hanger Spacer

Cat. No.	Description	Std. Pkg.
TC5254	1" long stackable spacer for messenger straps	50

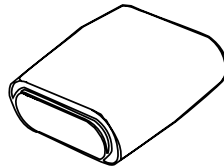

Spacer separating cable bundles

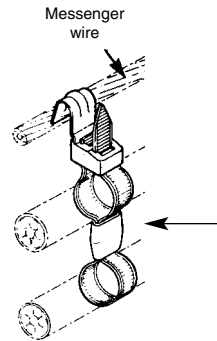

This one-inch long spacer allows you to separate power and signal cables with a single-hanger, lashing strap if desired. The spacer is stackable so that you may suspend the cable bundle at any desired distance from the messenger wire in order to keep the cable runs parallel.

Ty-Rap®/Ty-Fast®

Nylon 12 provides very good resistance to ultraviolet light and chemical exposure. Nylon 12 is a lower, moisture-absorbing material than 6/6 nylon and the effect of water on properties is much less.

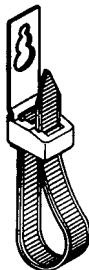

Nylon 12 provides very good resistance to ultraviolet light and chemical exposure. Nylon 12 is a lower, moisture-absorbing material than 6/6 nylon and the effect of water on properties is much less.

Weather-Resistant Nylon 12 Hanger Strap (releasable)

Cat. No.	Body Width (in.)	Length (in.)	Maximum Wire Bundle Diameter (in.)	Hook Material	Tensile Strength (lbs.)	Std. Pkg.
TY54407X	.500	6.36	2	Steel	200	50
TY54413X	.500	13.75	4	Steel	200	25

The recommended, maximum continuous static loading for the nylon 12 straps is 25 lbs. per strap. For best results suggested spacing is 15 inches. It is the responsibility of the user to determine whether or not their application meets our recommendation.

Thomas & Betts



Cable Ties-Material Selection Ordering Guide

Table 2-Physical Properties of Ty-Rap® Cable Tie Materials

		Natural 66 Nylon	Weather Resistant 66 Nylon	Heat Stabilized Natural 66 Nylon	Flame Retardant 66 Nylon	Weatherable Acetal	Weather Resistant Nylon 12	Weather Resistant Polypropylene	Tefzel 2	Halar 3	Stainless Steel
Tensile Strength (Yield)											
@ 73° F (Dry-As-Molded) ¹	psi	12,000	12,000	12,000	11,000	10,000	7500	4600	6,700	6,600	90,000
Flammability Rating	-	UL94V-2	UL94V-2	UL94V-2	UL94V-0	UL94HB	-	-	UL94V-0	UL94V-0	-
Radiation Resistance	rads	1 x 10 ⁵	1 x 10 ⁵	1 x 10 ⁵	1 x 10 ⁵	1 x 10 ⁶	1 x 10 ⁵	1 x 10 ⁵	2 x 10 ⁸	2 x 10 ⁸	2 x 10 ⁸
Ultraviolet Light Resistance	-	Poor	Good	Poor	Poor	Very Good	Good	Good	Excellent	Excellent	Excellent
Water Absorption (24 hrs)	%	1.3	1.2	1.4	1.4	0.25	0.25	0.1	<.01	<.01	None
Oxygen Index	-	28	28	31	34	21	-	-	30	52	-
Max. Continuous Use Temperature	F / C	185 /85	185 /85	221 / 105	185 /85	185 /85	176 / 80	185 /85	302 / 150	284 / 140	1000 / 537
Min. Continuous Use Temperature	F / C	-40 / -40	-40 / -40	-40 / -40	-40 / -40	-40 / -40	-40 / -40	-40 / -40	-50 / -46	-50 / -46	-112 /
Color	-	Natural	Black	Green tint	White	Black	Black	Black	Aqua	Maroon	Stainless

1. ASTM D638-878 except stainless steel which is ASTM E8
2. Tefzel is a trademark of E.I. DuPont deNemours and Company
3. Halar is a trademark of Solvay Slexis, Inc.



Thomas & Betts

Ty-Rap®

Cable Ties-Material Selection Ordering Guide

Flammability ratings for selecting Ty-Rap® cable ties

Note: Flammability ratings of Ty-Rap® cable tie materials are shown in Table 2. These tests for flammability of plastic material are intended to serve as a preliminary indication of acceptability with respect to flammability for particular applications.

UL 94 vertical burn test procedures

Test specimens of the material, with dimensions 5" x 1/2", with the thickness intended for use in the end product, are tested in both the manufactured condition and in the aged state. The test requires that the specimen be supported in a vertical fixture and a precisely controlled flame applied for a 10 second period. The flame is removed and the duration of flaming is noted. If the flame extinguishes, a second exposure to flame for 10 seconds is applied and duration of flaming is again noted. It is observed and recorded whether or not test specimens drip flaming particles that ignite a cotton swatch.

Ty-Rap®/Ty-Fast®

Materials classed V-0:

A material classed V-0 shall:

- A. Not have any specimens that burn with flaming combustion for more than 10 seconds after either application of the test flame.
- B. Not have a total flaming combustion time exceeding 50 seconds for the 10 flame applications for each set of five specimens.
- C. Not have any specimens that burn with flaming or glowing combustion up to the holding fixture.
- D. Not have any specimens that drip flaming particles that ignite the dry absorbent surgical cotton located 12" below the test specimen.
- E. Not have any specimens with glowing combustion that persists for more than 30 seconds after the second removal of the test flame.

Materials classed V-1:

A material classed V-1 shall:

- A. Not have any specimens that burn with flaming combustion for more than 30 seconds after either application of the test flame.
- B. Not have a total flaming combustion time exceeding 250 seconds for the 10 flame applications for each set of five specimens.
- C. Not have any specimens that burn with flaming or glowing combustion up to the holding fixture.
- D. Not have any specimens that drip flaming particles that ignite the dry absorbent surgical cotton located 12" below the test specimen.
- E. Not have any specimens with glowing combustion that persists for more than 60 seconds after the second removal of the test flame.

Materials classed V-2:

A material classed V-2 shall:

- A. Not have any specimens that burn with flaming combustion for more than 30 seconds after either application of the test flame.
- B. Not have a total flaming combustion time exceeding 250 seconds for the 10 flame applications for each set of five specimens.
- C. Not have any specimens that burn with flaming or glowing combustion up to the holding fixture.
- D. Be permitted to have specimens that drip flaming particles that burn only briefly, some of which ignite the dry absorbent surgical cotton placed 12" below the test specimen.
- E. Not have any specimens with glowing combustion that persists for more than 60 seconds after the second removal of the test flame.

Thomas & Betts

Ty-Rap®

Cable Ties-Material Selection Ordering Guide

Chemical resistance

Table 3 shows the resistance of Ty-Rap® cable tie materials to various chemicals. The table is designed to help you determine the cable tie material best suited for a particular chemical environment.

Table 3-Resistance of Available Materials to Various Chemicals Temp 70°F

Reagents	Concentration	Heat-Stabilized 6/6	Halar† as	Weatherable	Standard 6/6	6/6 Weather-	6/6 Fire-	Weather-	Polypropylene	Weather-	Polypropylene	Stainless	
		Nylon as	Used in TYV	Acetal as	Nylon as	Resistant	Retardant	Resistant	as Used in	Resistant	as Used in	Steel as	
		Used in TYH	Series	Used in TYD	Used in TY	Nylon as	Nylon as	Nylon 12 as	Used in TYP	Nylon 12 as	Used in TYP	Used in TYS	
			Series			X Series	FR Series	X Series	Series	X Series	Series	Series	
Arsenic Acid	40%	—	—	—	—	—	—	—	E	—	E	—	E
Acetaldehyde	50%	S	—	—	S	S	S	—	—	—	—	—	—
Acetone	100%	E	E	F	E	E	E	E	E	E	E	E	E
Aluminum Hydroxide	AQ	—	E	—	—	—	—	—	E	E	E	E	E
Ammonia	All	—	E	—	—	—	—	E	E	E	E	E	E
Ammonium Carbonate	5%	S	E	—	S	S	S	E	E	E	E	E	E
Ammonium Hydroxide	10%	E	E	F	E	E	E	—	E	E	E	E	E
Ammonium Nitrate	—	—	E	—	—	—	—	E	E	E	E	E	E
Ammonium Sulfate	10%	—	E	—	—	—	—	S	S	S	S	S	S
Barium Carbonate	All	—	E	—	—	—	—	E	E	E	E	E	E
Barium Chloride	5%	NR	—	—	NR	NR	NR	E	E	E	E	E	E
Barium Sulfate	10%	E	—	—	E	E	E	E	E	E	E	E	E
Barium Sulfide	10%	S	—	—	S	S	S	E	E	E	E	E	E
Benzene	100%	E	E	F	E	E	E	E	S	S	E	E	E
Benzoic Acid	100%	NR	E	—	NR	NR	NR	E	E	E	E	E	E
Butyric Acid	50%	NR	E	—	NR	NR	NR	—	E	E	E	E	E
Calcium Carbonate	AQ	—	E	—	—	—	—	—	E	E	E	E	E
Calcium Hydroxide	20%	—	F	E	—	—	—	—	E	E	E	E	E
Calcium Hydrochlorite	2	NR	—	—	NR	NR	NR	—	F	F	F	F	F
Calcium Sulfate	2%	—	E	—	—	—	—	—	E	E	E	E	E
Carbon Tetrachloride	100%	E	E	E	E	E	E	E	F	F	E	E	E
Chlorine (WET)	—	NR	—	—	NR	NR	NR	—	F	F	F	F	F
Chlorine (DRY)	—	NR	—	—	NR	NR	NR	—	NR	NR	F	F	F
Chloroacetic Acid	30%	NR	—	—	NR	NR	NR	—	—	—	F	F	F
Chloroform	100%	—	E	—	—	—	—	F	F	F	E	E	E
Chromic Acid	50%	NR	S	—	NR	NR	NR	—	F	F	F	F	F
Citric Acid	50%	S	E	E	S	S	S	E	E	E	E	E	E
Copper Cyanide	10%	—	E	—	—	—	—	—	E	E	E	E	E
Copper Nitrate	50%	—	E	—	—	—	—	—	E	E	E	E	E
Cider	—	—	E	—	—	—	—	—	E	E	E	E	E
Dichloroethane	100%	—	E	—	—	—	—	—	—	—	E	E	E
Diethyl Ether	100%	—	E	S	—	—	—	E	E	E	E	E	E
Ethyl Alcohol	100%	S	E	—	S	S	S	E	E	E	E	E	E

* Trademark of E.I. DuPont deNemours and Company

† Trademark of Ausimont

Ratings

E = Excellent

S = Satisfactory

F = Fair

NR = Not Recommended

(**AQ** = Aqueous)



Ty-Rap®

Cable Ties-Material Selection Ordering Guide

Table 3-continued

Reagents	Concentration	Heat-Stabilized 6/6 Nylon as Used in TYH	Halar® as Used in TYV	Weatherable Acetal as Used in TYD	Standard 6/6 Nylon as Used in TY	6/6 Weather-Resistant Nylon as Used in TY	6/6 Fire-Retardant Nylon as Used in TY	Weather-Resistant Nylon 12 as Used in TYC	Polypropylene as Used in TYP	Weather-Resistant Polypropylene as Used in TYP	Tefzel® as Used in TYZ	Stainless Steel as Used in TYS
		Series	Series	Series	Series	X Series	FR Series	X Series	Series	X Series	Series	Series
Ethyl Chloride	100%	—	S	E	—	—	—	F	F	F	E	E
Ethylene Glycol	100%	E	E	S	E	E	E	—	E	E	E	E
Ferric Hydroxide	All	—	E	—	—	—	—	—	E	E	E	E
Ferric Nitrate	10%	—	E	—	—	—	—	—	E	E	E	E
Ferrous Sulfate	10%	—	E	—	—	—	—	—	E	E	E	E
Fuel Oil	100%	—	E	—	—	—	—	E	—	—	E	E
Furfural	100%	—	E	—	—	—	—	—	F	F	E	E
Gallic Acid	AQ	—	E	—	—	—	—	—	—	—	E	E
Gasoline	100%	E	E	—	E	E	E	—	S	S	E	E
Glycerine	100%	—	E	—	—	—	—	E	E	E	—	E
Hydrocyanic Acid	All	—	E	—	—	—	—	—	E	E	E	E
Hydrogen Peroxide	30%	NR	E	F	NR	NR	NR	S	E	E	E	E
Hydrogen Sulfide	Dry	NR	E	—	NR	NR	NR	E	E	E	E	E
Iodoform	100%	—	E	—	—	—	—	—	—	—	E	E
Isopropyl Alcohol	100%	S	E	—	S	S	S	E	E	E	E	E
Jet Fuel	100%	E	E	—	E	E	E	—	S	S	E	E
Lactic Acid	10%	E	E	—	E	E	E	S	E	E	E	E
Lanolin	10%	E	E	—	E	E	E	E	E	E	E	E
Lead Acetate	5%	—	E	—	—	—	—	—	E	E	E	E
Linseed Oil	10%	E	E	E	E	E	E	E	E	E	E	E
Magnesium Carbonate	All	—	E	—	—	—	—	E	E	E	E	E
Magnesium Chloride	10%	F	—	—	F	F	F	F	F	F	F	F
Magnesium Nitrate	All	—	E	—	—	—	—	E	E	E	E	E
Malic Acid	AQ	—	E	—	—	—	—	—	E	E	E	E
Mercury	100%	—	E	—	—	—	—	E	E	E	E	E
Methyl Alcohol	100%	S	E	—	S	S	S	E	E	E	E	E
Methyl Chloride	100%	—	S	—	—	—	—	—	S	S	E	E
Methyl Ethyl Ketone	100%	—	E	F	—	—	—	E	E	E	E	E
Naptha	100%	—	E	—	—	—	—	—	E	E	E	E
Nitric Acid	30%	NR	E	NR	NR	NR	NR	—	E	E	E	E
Nitric Acid	30-70%	NR	S	NR	NR	NR	NR	—	F	F	S	E
Nitrous Acid	5%	—	E	—	—	—	—	—	F	F	E	E
Oleic Acid	100%	—	E	S	—	—	—	—	E	E	E	E
Oxalic Acid	10%	—	E	—	—	—	—	S	E	E	E	E
Paraffin	100%	E	E	—	E	E	E	E	E	E	E	E
Petroleum Ether	100%	—	E	—	—	—	—	E	F	F	E	E
Phenol	90%	NR	E	NR	NR	NR	NR	—	E	E	E	E
Phosphoric Acid	10%	NR	E	—	NR	NR	NR	—	E	E	E	E
Picric Acid	1%	—	E	—	—	—	—	—	E	E	E	E
Potassium Bromide	AQ	—	—	—	—	—	—	—	S	S	S	S

Ty-Rap®/Ty-Fast®



Ty-Rap®

Cable Ties-Material Selection Ordering Guide

Table 3—continued

Reagents	Concentration	Heat-	Halart [†]	Weatherable	Standard 6/6	6/6 Weather-	6/6 Fire-	Weather-	Polypropylene	Weather-	Tefzel* as	Stainless
		Stabilized 6/6 Nylon as Used in TYH	as Used in TYV	Acetal as Used in TYD	Nylon as Used in TY	Resistant Nylon as Used in TY	Retardant Nylon as Used in TY	Resistant Nylon 12 as Used in TYC	as Used in TYP	Polypropylene as Used in TYP	Resistant as Used in TYP	Used in TYZ
		Series	Series	Series	Series	X Series	FR Series	X Series	Series	X Series	Series	Series
Potassium Carbonate 1%	—	E	—	—	—	—	E	E	E	E	E	E
Potassium Chlorate	AQ	—	E	—	—	—	—	S	E	E	E	E
Potassium Dichromate	40%	NR	E	—	NR	NR	NR	F	E	E	E	E
Potassium Ferrocyanide	25%	—	E	—	—	—	—	—	E	E	E	E
Potassium Hydroxide	5%	S	E	—	S	S	S	—	E	E	E	E
Potassium Iodide	All	—	E	—	—	—	—	E	E	E	E	E
Potassium Nitrate	50%	F	E	—	F	F	F	E	E	E	E	E
Potassium Permanganate	5%	NR	E	S	NR	NR	NR	NR	E	E	E	E
Potassium Sulfate	5%	—	E	—	—	—	—	E	E	E	E	E
Potassium Sulfide	AQ	—	E	—	—	—	—	—	E	E	E	E
Propyl Alcohol	100%	E	E	—	E	E	E	—	E	E	E	E
Silver Nitrate	10%	—	E	—	—	—	—	E	E	E	E	E
Sodium Acetate	60%	E	E	—	E	E	E	—	E	E	E	E
Sodium Bicarbonate	All	E	E	—	E	E	E	E	E	E	E	E
Sodium Bisulfate	10%	—	E	E	—	—	—	E	E	E	E	E
Sodium Borate	All	—	E	—	—	—	—	—	E	E	E	E
Sodium Carbonate	5%	E	E	S	E	E	E	E	E	E	E	E
Sodium Chlorate	25%	—	E	E	—	—	—	S	E	E	E	E
Sodium Chloride	2%	E	E	S	E	E	E	E	E	E	E	E
Sodium Fluoride	5%	—	—	—	—	—	—	—	F	F	F	F
Sodium Hydroxide	10%	E	E	S	E	E	E	E	E	E	E	E
Sodium Hyposulfite	AQ	—	E	—	—	—	—	—	—	—	E	E
Sodium Nitrate	5%	E	E	—	E	E	E	E	E	E	E	E
Sodium Nitrite	AQ	—	E	—	—	—	—	S	E	E	E	E
Sodium Perchlorate	10%	—	E	—	—	—	—	—	—	—	E	E
Sodium Phosphate	5%	—	E	—	—	—	—	E	E	E	E	E
Sodium Sulfate	5%	S	E	—	S	E	E	E	E	E	E	E
Sodium Thiosulfate	5%	—	—	S	—	—	—	S	S	S	S	S
Stearic Acid	100%	—	E	—	—	—	—	F	E	E	E	E
Sulfur	100%	—	E	—	—	—	—	E	E	E	E	E
Sulfur Dioxide	All	NR	E	—	NR	NR	NR	E	E	E	E	E
Sulfuric Acid	Conc.	NR	E	NR	NR	NR	NR	—	S	S	E	E
Sulfuric Acid	5%	NR	F	F	NR	NR	NR	F	F	F	F	F
Tannic Acid	10%	—	E	—	—	—	—	—	E	E	E	E
Tartaric Acid	50%	—	E	E	—	—	—	E	E	E	E	E
Tetrahydrofuran	100%	—	F	E	—	—	—	S	F	F	E	E
Toluene	100%	E	E	F	E	E	E	E	F	F	E	F
Xylene	100%	E	—	—	E	E	E	E	F	F	E	E
Zinc Chloride	70%	F	E	NR	F	F	F	E	E	E	E	E
Zinc Nitrate	AQ	—	E	—	—	—	—	E	E	E	E	E
Zinc Sulfate	AQ	—	E	—	—	—	—	E	E	E	E	E

* Trademark of E.I. DuPont deNemours and Company

† Trademark of Ausimont

Ratings

E = Excellent

S = Satisfactory

F = Fair

NR = Not Recommended

(**AQ** = Aqueous)



Ty-Fast® Cable Ties

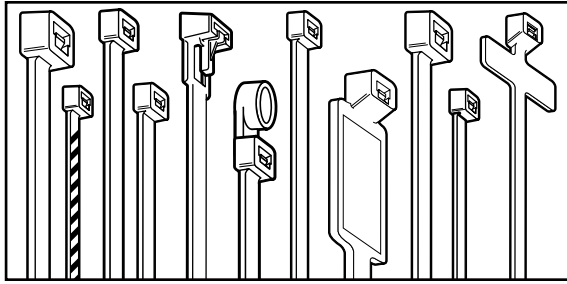

- MINIATURE
- HEAVY DUTY
- INTERMEDIATE
- EXTRA HEAVY DUTY
- STANDARD
- RELEASABLE TIES

- MOUNTING HEAD
- STRIPED TIES
- RESTRICTED BUNDLE
- IDENTIFICATION TIES
- MIL-SPEC TIES

Ty-Fast® Cable Ties are available in lengths from 4" to our exclusive 48" strap. Cable Ties will satisfy bundling requirements from 1/16" to 15" and loop tensile strengths from 18 to 175 pounds.

Cable Ties are stocked in materials and colors as listed. Contact your Ty-Fast® Distributor or Customer Service Representative for availability in special materials and colors.

Where applicable, Ty-Fast® Cable Ties are UL Recognized, Mil-Spec Approved and/or QPL Listed.

State-of-the-art robotic and raw material handling equipment assures product and material integrity throughout the manufacturing process. Overall quality is achieved through statistical analysis and quality driven operator objectives. Ty-Fast® has attained Mil-Spec I-45208 quality ratings from a number of equipment manufacturers.

Ty-Fast® products are sold through stocking T&B Distributors.

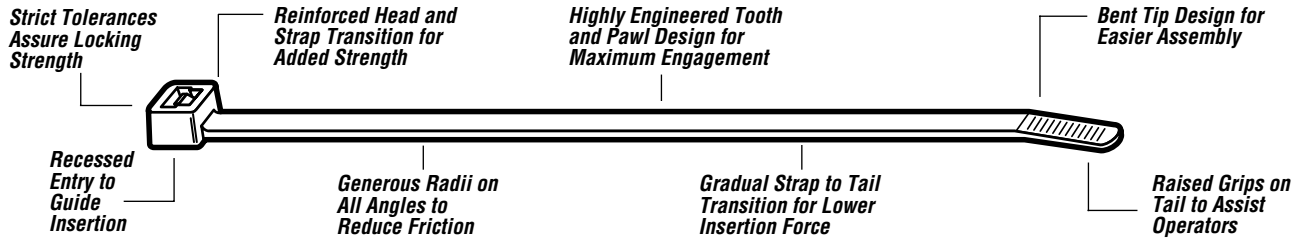

Ty-Rap®/Ty-Fast®

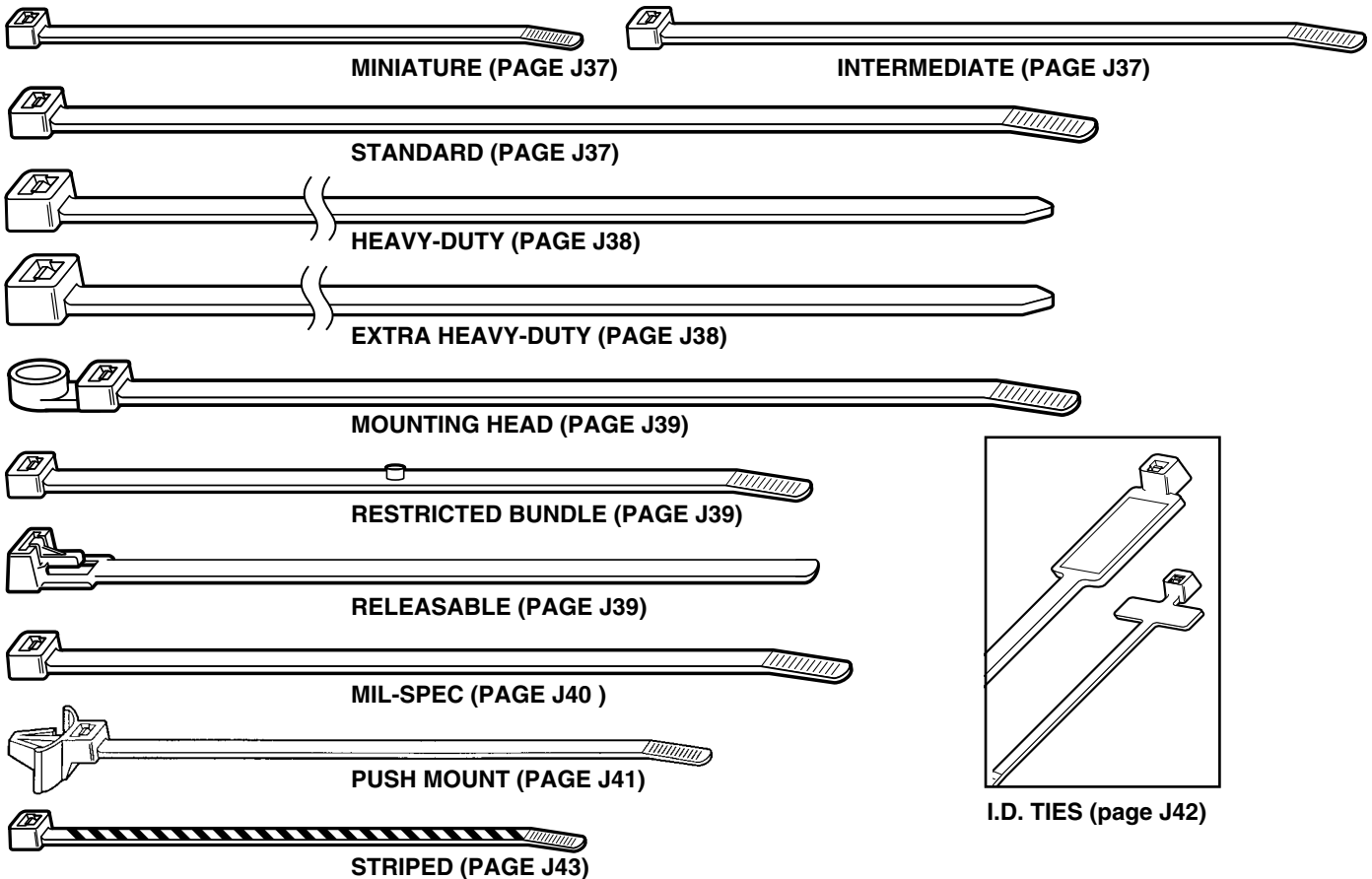

Thomas & Betts

Ty-Fast® Cable Ties

Part Number Construction

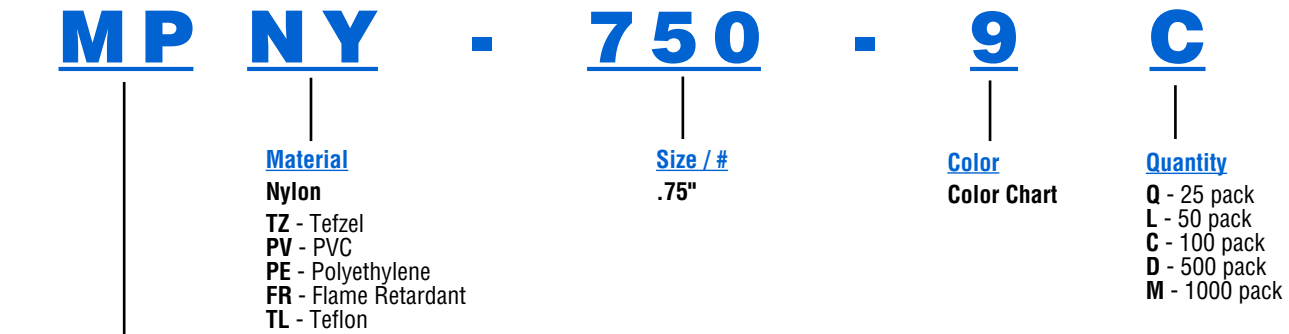
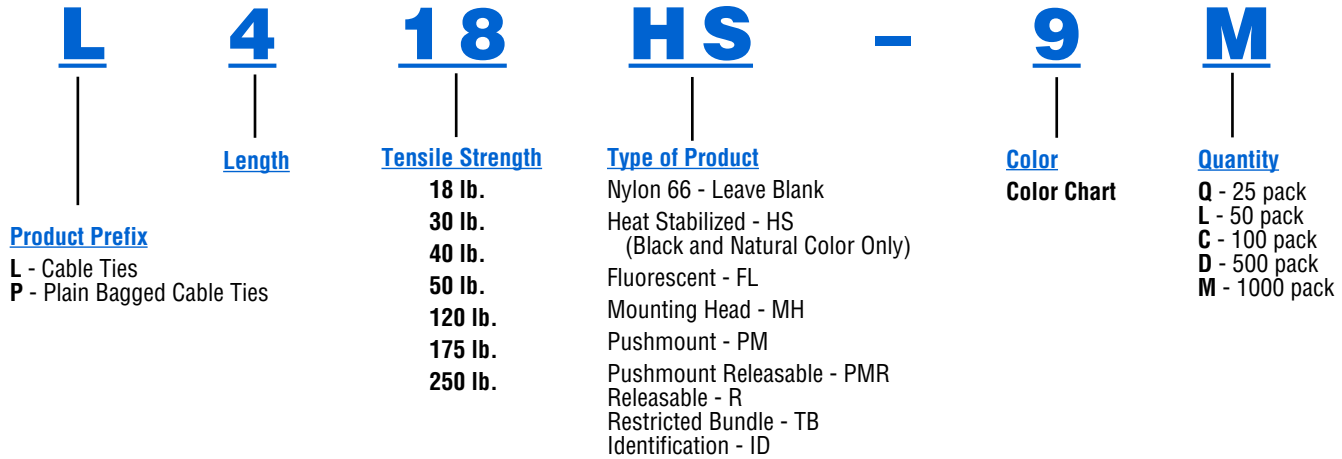

Color Table

0 - Black (Weather Resistant)	7 - Purple
1 - Brown	8 - Gray
2 - Red	9 - Natural
3 - Orange	11 - Fluorescent Pink
4 - Yellow	16 - Fluorescent Orange
5 - Green	17 - Fluorescent Yellow
6 - Blue	18 - Fluorescent Green
	20 - Fluorescent Blue

Thomas & Betts

Ty-Fast® Cable Ties

Materials for Molded Assembly Hardware

Property	ASTM Method	Test Condition	Units	Molded 6/6 Nylon	Heat Stabilized Nylon	UV Black Nylon
Tensile Strength	D638	+73°F; 50% RH	kpsi	11.2	11.2	9.0
Elongation at Break	D638	+73°F; 50% RH	%	≥300	≥300	200
Yield Strength	D638	+73°F; 50% RH	kpsi	8.5	8.5	9.0
Shear Strength	D732	Dry As Molded (DAM)	kpsi	9.6	9.6	10.5
Deformation Under Load	D621	2,000 psi +122°F; DAM	%	1.4	1.4	1.2
IZOD Impact	D256	+73°F; 50% RH	ft lb/in	2.1	2.1	2.0
Tensile Impact Strength	D1822	+73°F; Long Specimen; DAM	ft lb/in ²	240	240	N.R.
Melting Point	D789	Fisher-Johns	°F	491	491	491
Thermal Linear Expansion	D696	DAM	in/in/°F	4 x 10 ⁻⁵	4 x 10 ⁻⁵	N.R.
Thermal Conductivity	–	DAM Conche-Fitch	BTU - in/h . ft ² . °F	1.7	1.7	1.7
Brittleness Temperature	D746	50% RH	°F	-85	-85	-62
Oxygen Index	D2863	DAM 50% RH	%O ₂	28 31	28 31	25 31
UL Flammability	UL 94	DAM 50% RH	– –	V-2 V-2	V-2 V-2	V-2 V-2

- Material data as provided by our suppliers.
- Tests conducted on 1/4" specimens.
- N.R. = Not Reported

Ty-Rap®/Ty-Fast®

About Nylon...

Nylons possess an outstanding balance of properties combining strength, moderate stiffness, high service temperature and a high level of toughness. Nylon is particularly resistant to repeated impact, has a low co-efficient of friction and excellent abrasion resistance.

Nylon is resistant to fuels, lubricants and most chemicals, but is attacked by phenols, strong acids and oxidizing agents. Contact your Ty-Fast® Customer Service Representative or your Ty-Fast® Distributor for chemical data relative to your application.

Nylon is inherently susceptible to environmental conditions. Ty-Fast® Cable Ties are moisturized to optimum performance levels at machine-side and should be stored in cool dry areas out of direct sunlight. Cable Ties are packaged in plastic bags to contain moisture and should remain sealed until ready for use.

NBS Smoke Generation for 6/6 Nylon

Sample Thickness	UL Flammability	Energy Source	Specific Optical Density	
			at Maximum Smoke Accumulation	at 2 Minutes
1/16"	94 V-2	Radiant (2.5 watts/sq cm)	13	0
1/8"	94 V-2	Radiant Plus Flaming Gas Jets	26	1

- Results as provided by National Bureau of Standards (NBS). Results may not be directly correlated with larger fires, such as burning buildings. Materials should be tested to your application.

Temperature Index for Molded Nylons

Material	Minimum Thickness (in)	Temperature Index		
		Electrical (°C)	Mechanical w/o Impact (°C)	Hot Wire Ignition (sec)
6/6 Nylon	.058	125	85	15.0
UV Black Nylon	.120	125	85	35.0
Nylon	.240	125	85	35.0
Heat Stabilized Nylon	.058	130	105	11.0
Stabilized Nylon	.120	130	110	20.0

- Temperature Index is the temperature at which the specific property will decrease to one-half its original value after 60,000 hours exposure at that temperature.

Thomas & Betts

Ty-Fast® Cable Ties

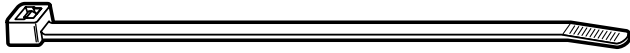

Miniature – Series 18

Std. Cat. No.	Bulk Cat. No.	Material	Color	Bundle Diameter		Length		Width		Minimum Loop Tensile		Std. Pkg.	Bulk Pkg.
				Inch	(mm)	Inch	(mm)	Inch	(mm)	LB	(kg)		
L-4-18-9-C	L-4-18-9-M	Nylon	Natural	1/16 - 5/16	(2-16)	4.0	(102)	.100	(3)	18	(8.2)	100	1000
L-4-18-0-C	L-4-18-0-M	Nylon	Black	1/16 - 5/16	(2-16)	4.0	(102)	.100	(3)	18	(8.2)	100	1000
L-6-18-9-C	L-6-18-9-M	Nylon	Natural	1 1/16 - 1 1/2	(2-38)	6.4	(163)	.100	(3)	18	(8.2)	100	1000
L-6-18-0-C	L-6-18-0-M	Nylon	Black	1 1/16 - 1 1/2	(2-38)	6.4	(163)	.100	(3)	18	(8.2)	100	1000
L-8-18-9-C	L-8-18-9-M	Nylon	Natural	1/8 - 2	(2-51)	8.0	(202)	.100	(3)	18	(8.2)	100	1000
L-8-18-0-C	L-8-18-0-M	Nylon	Black	1/8 - 2	(2-51)	8.0	(202)	.100	(3)	18	(8.2)	100	1000

• Use QC-100, L-200, L-400-C, or ERG-299 Installation Tools.
Consult Customer Service for availability and colors.

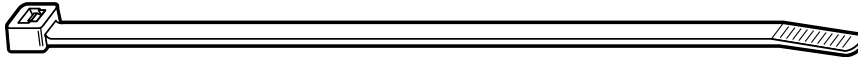

Intermediate - Series 30

Std. Cat. No.	Bulk Cat. No.	Material	Color	Bundle Diameter		Length		Width		Minimum Loop Tensile		Std. Pkg.	Bulk Pkg.
				Inch	(mm)	Inch	(mm)	Inch	(mm)	LB	(kg)		
L-5-30-9-C	L-5-30-9-M	Nylon	Natural	1/8 - 1 1/4	(2-32)	5.6	(145)	.130	(3)	30	(13.6)	100	1000
L-5-30-0-C	L-5-30-0-M	Nylon	Black	1/8 - 1 1/4	(2-32)	5.6	(145)	.130	(3)	30	(13.6)	100	1000
L-8-40-9-C	L-8-40-9-M	Nylon	Natural	1/8-2	(2-51)	8.5	(215)	.140	(3)	40	(18.2)	100	1000
L-8-40-0-C	L-8-40-0-M	Nylon	Black	1/8-2	(2-51)	8.5	(215)	.140	(3)	40	(18.2)	100	1000
L-11-40-9-C	L-11-40-9-D	Nylon	Natural	1/8-3	(2-76)	11.5	(282)	.146	(4)	40	(18.2)	100	500
L-11-40-0-C	L-11-40-0-D	Nylon	Black	1/8-3	(2-76)	11.5	(282)	.146	(4)	40	(18.2)	100	500
L-14-40-9-C	L-14-40-9-D	Nylon	Natural	1/8-4	(2-102)	14.5	(358)	.146	(4)	40	(18.2)	100	500
L-14-40-0-C	L-14-40-0-D	Nylon	Black	1/8-4	(2-102)	14.5	(358)	.146	(4)	40	(18.2)	100	500

• Use QC-100, L-200, L-400-C, or ERG-299 Installation Tools.
Consult Customer Service for availability and colors.

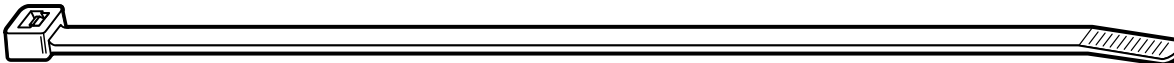

Standard - Series 50

Std. Cat. No.	Bulk Cat. No.	Material	Color	Bundle Diameter		Length		Width		Minimum Loop Tensile		Std. Pkg.	Bulk Pkg.
				Inch	(mm)	Inch	(mm)	Inch	(mm)	LB	(kg)		
L-5-50-9-C	L-5-50-9-M	Nylon	Natural	1/8-1	(2-25)	5.5	(140)	.187	(5)	50	(22.7)	100	1000
L-5-50-0-C	L-5-50-0-M	Nylon	Black	1/8-1	(2-25)	5.5	(140)	.187	(5)	50	(22.7)	100	1000
L-7-50-9-C	L-7-50-9-M	Nylon	Natural	1/8-1 3/4	(2-44)	7.5	(193)	.187	(5)	50	(22.7)	100	1000
L-7-50-0-C	L-7-50-0-M	Nylon	Black	1/8-1 3/4	(2-44)	7.5	(193)	.187	(5)	50	(22.7)	100	1000
L-11-50-9-C	L-11-50-9-D	Nylon	Natural	1/8-3	(2-76)	11.1	(282)	.187	(5)	50	(22.7)	100	500
L-11-50-0-C	L-11-50-0-D	Nylon	Black	1/8-3	(2-76)	11.1	(282)	.187	(5)	50	(22.7)	100	500
L-14-50-9-C	L-14-50-9-D	Nylon	Natural	1/8-4	(2-102)	14.1	(358)	.187	(5)	50	(22.7)	100	500
L-14-50-0-C	L-14-50-0-D	Nylon	Black	1/8-4	(2-102)	14.1	(358)	.187	(5)	50	(22.7)	100	500

• Use QC-100, L-200, L-400-C, or ERG-299 Installation Tools.
Consult Customer Service for availability and colors.

Sample Catalog Order:

L 4 18 9 C = Natural Color Type

0 – Black (Outdoor)	5 – Green	11 – Fluorescent Pink
1 – Brown	6 – Blue	16 – Fluorescent Orange
2 – Red	7 – Purple	17 – Fluorescent Yellow
3 – Orange	8 – Gray	18 – Fluorescent Green
4 – Yellow	9 – Natural	20 – Fluorescent Blue

Thomas & Betts

Ty-Rap®/Ty-Fast®

Ty-Fast[®]

Cable Ties

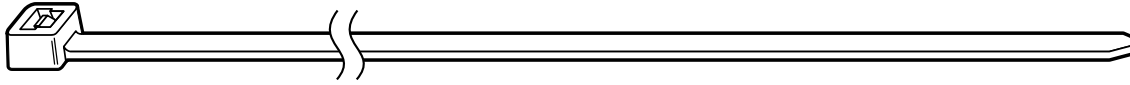

Heavy Duty - Series 120

Std. Cat. No.	Material	Color	Bundle Diameter		Length		Width		Minimum Loop Tensile		Std. Pkg.
			Inch	(mm)	Inch	(mm)	Inch	(mm)	LB	(kg)	
L-8-120-9-C	Nylon	Natural	3/16-2	(5-51)	8.0	(202)	.300	(8)	120	(54.4)	100
L-8-120-0-C	Nylon	Black	3/16-2	(5-51)	8.0	(202)	.300	(8)	120	(54.4)	100
L-11-120-9-C	Nylon	Natural	3/16-3	(5-76)	11.1	(282)	.300	(8)	120	(54.4)	100
L-11-120-0-C	Nylon	Black	3/16-3	(5-76)	11.1	(282)	.300	(8)	120	(54.4)	100
L-14-120-9-C	Nylon	Natural	3/16-4	(5-102)	14.2	(363)	.300	(8)	120	(54.4)	100
L-14-120-0-C	Nylon	Black	3/16-4	(5-102)	14.2	(363)	.300	(8)	120	(54.4)	100
L-18-120-9-L	Nylon	Natural	3/16-4 7/8	(5-124)	18.0	(457)	.300	(8)	120	(54.4)	50
L-18-120-0-L	Nylon	Black	3/16-4 7/8	(5-124)	18.0	(457)	.300	(8)	120	(54.4)	50
L-24-120-9-L	Nylon	Natural	3/16-7	(5-178)	24.2	(616)	.300	(8)	120	(54.4)	50
L-24-120-0-L	Nylon	Black	3/16-7	(5-178)	24.2	(616)	.300	(8)	120	(54.4)	50
L-28-120-9-L	Nylon	Natural	3/16-9	(5-230)	28.0	(816)	.300	(8)	120	(54.4)	50
L-28-120-0-L	Nylon	Black	3/16-9	(5-230)	28.0	(816)	.300	(8)	120	(54.4)	50

• Use L-300C or ERG-297 Installation Tool. Consult Customer Service for availability and colors.



Ty-Rap[®]/Ty-Fast[®]

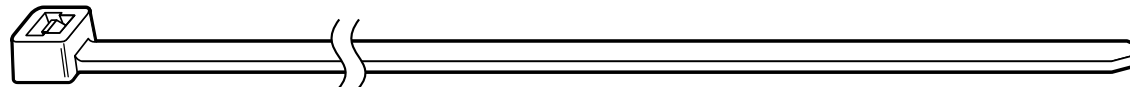

Extra Heavy Duty - Series 175

Std. Cat. No.	Material	Color	Bundle Diameter		Length		Width		Minimum Loop Tensile		Std. Pkg.
			Inch	(mm)	Inch	(mm)	Inch	(mm)	LB	(kg)	
L-24-175-9-L	Nylon	Natural	3/16-7.2	(5-184)	24.0	(612)	.345	(9)	175	(79.3)	50
L-24-175-0-L	Nylon	Black	3/16-7.2	(5-184)	24.0	(612)	.345	(9)	175	(79.3)	50
L-34-175-9-L	Nylon	Natural	3/16-10	(5-254)	34.0	(864)	.345	(9)	175	(79.3)	50
L-36-175-9-L	Nylon	Natural	2 3/4-10 3/4	(70-273)	36.0	(914)	.345	(9)	175	(79.3)	50
L-36-175-0-L	Nylon	Black	2 3/4-10 3/4	(70-273)	36.0	(914)	.345	(9)	175	(79.3)	50
L-41-175-9-L	Nylon	Natural	3/16-12	(5-305)	41.0	(1032)	.345	(9)	175	(79.3)	50
L-41-175-0-L	Nylon	Black	3/16-12	(5-305)	41.0	(1032)	.345	(9)	175	(79.3)	50
L-48-175-9-L	Nylon	Natural	3/16-15	(5-375)	48.0	(1216)	.345	(9)	175	(79.3)	50
L-48-175-0-L	Nylon	Black	3/16-15	(5-375)	48.0	(1216)	.345	(9)	175	(79.3)	50

• Use L-300C Installation Tool. Consult Customer Service for availability and colors.

Sample Catalog Order:

L 4 18 9 C = Natural Color Type

Color Table

0 – Black (Outdoor)	5 – Green	11 – Fluorescent Pink
1 – Brown	6 – Blue	16 – Fluorescent Orange
2 – Red	7 – Purple	17 – Fluorescent Yellow
3 – Orange	8 – Gray	18 – Fluorescent Green
4 – Yellow	9 – Natural	20 – Fluorescent Blue

Thomas & Betts

Ty-Fast® Cable Ties

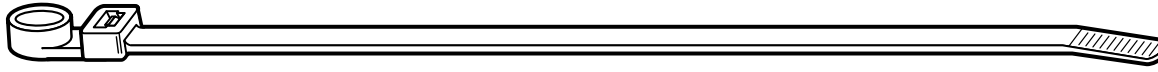

Mounting Head Ties

Std. Cat. No.	Cat. No. Bulk	Material	Color	Bundle Diameter		Length		Width		Minimum Loop Tensile		Mounting Head Screw Size	Std. Pkg.	Bulk Pkg.
				Inch	(mm)	Inch	(mm)	Inch	(mm)	LB	(kg)			
L-5-30MH-9-C	L-5-30MH-9-M	Nylon	Natural	1/16 - 1/4	(2 - 32)	5.85	(148.6)	.140	(4)	30	(13.6)	No. 8	100	1000
L-5-30MH-0-C	L-5-30MH-0-M	Nylon	Black	1/16 - 1/4	(2 - 32)	5.85	(148.6)	.140	(4)	30	(13.6)	No. 8	100	1000
L-7-50MH-9-C	L-7-50MH-9-M	Nylon	Natural	1/16 - 1/4	(2 - 44)	7.5	(191)	.185	(5)	30	(13.6)	No. 10	100	1000
L-7-50MH-0-C	L-7-50MH-0-M	Nylon	Black	1/16 - 1/4	(2 - 44)	7.5	(191)	.185	(5)	30	(13.6)	No. 10	100	1000
L-11-50MH-9-C	L-11-50MH-9-D	Nylon	Natural	1/16 - 3	(2 - 76)	11.1	(282)	.187	(5)	50	(22.7)	No. 10	100	500
L-11-50MH-0-C	L-11-50MH-0-D	Nylon	Black	1/16 - 3	(2 - 76)	11.1	(282)	.187	(5)	50	(22.7)	No. 10	100	500
L-14-50MH-9-C	L-14-50MH-9-D	Nylon	Natural	1/16 - 4	(2 - 102)	14.5	(365)	.187	(5)	50	(22.7)	No. 10	100	500
L-14-50MH-0-C	L-14-50MH-0-D	Nylon	Black	1/16 - 4	(2 - 102)	14.5	(365)	.187	(5)	50	(22.7)	No. 10	100	500
L-14-120MH-9-C		Nylon	Natural	3/16 - 4	(5 - 102)	14.85	(374)	.300	(8)	120	(54.4)	1/4 inch	100	-
L-14-120MH-0-C		Nylon	Black	3/16 - 4	(5 - 102)	14.85	(374)	.300	(8)	120	(54.4)	1/4 inch	100	-

• Use QC-100, L-200, L-400-C, ERG-297, or ERG-299 Installation Tool. Consult Customer Service for availability and colors.

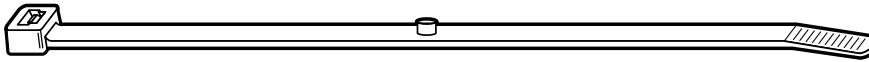

Restricted Bundle

Std. Cat. No.	Cat. No. Bulk	Material	Color	Bundle Diameter		Length		Width		Minimum Loop Tensile		Tab Height		Std. Pkg.	Bulk Pkg.
				Inch	(mm)	Inch	(mm)	Inch	(mm)	LB	(kg)	Inch	(mm)		
TB-5-30TB-3-M		Nylon	Orange	2 1/32 - 1 1/4	(17 - 32)	5.6	(142)	.130	(3)	30	(13.6)	.062	(1.58)	-	1000

• Recommended for tote-box, security and temporary applications.
 • Use QC-100, L-200, L-400-C, or ERG-299 Installation Tools on Low setting. Consult Customer Service for availability and colors.

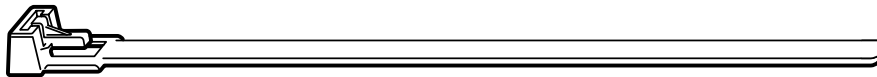

Releasable Ties

Std. Cat. No.	Cat. No. Bulk	Material	Color	Bundle Diameter		Length		Width		Minimum Loop Tensile		Std. Pkg.	Bulk Pkg.
				Inch	(mm)	Inch	(mm)	Inch	(mm)	LB	(kg)		
L-5-50R-9-C	L-5-50R-9-D	Nylon	Natural	1/8 - 1 1/4	(3 - 32)	5.9	(150)	.295	(7.5)	50	(22.7)	100	500
L-5-50R-0-C	L-5-50R-0-D	Nylon	Black	1/8 - 1 1/4	(3 - 32)	5.9	(150)	.295	(7.5)	50	(22.7)	100	500
L-8-50R-9-C	L-8-50R-9-D	Nylon	Natural	1/8 - 2	(3 - 51)	7.8	(198)	.295	(7.5)	50	(22.7)	100	500
L-8-50R-0-C	L-8-50R-0-D	Nylon	Black	1/8 - 2	(3 - 51)	7.8	(198)	.295	(7.5)	50	(22.7)	100	500
L-10-50R-9-C	L-10-50R-9-D	Nylon	Natural	1/8 - 3	(3 - 76)	11.265	(286)	.295	(7.5)	50	(22.7)	100	500
L-10-50R-0-C	L-10-50R-0-D	Nylon	Black	1/8 - 3	(3 - 76)	11.265	(286)	.295	(7.5)	50	(22.7)	100	500

• Push Button Release.
 • Use QC-100, L-200, L-400-C, ERG-297, ERG-299 Installation Tool. Consult Customer Service for availability and colors.

Sample Catalog Order:

L 4 18 9 C = Natural Color Type

0 - Black (Outdoor)	5 - Green	11 - Fluorescent Pink
1 - Brown	6 - Blue	16 - Fluorescent Orange
2 - Red	7 - Purple	17 - Fluorescent Yellow
3 - Orange	8 - Gray	18 - Fluorescent Green
4 - Yellow	9 - Natural	20 - Fluorescent Blue

Thomas & Betts

Ty-Fast® Cable Ties

Ty-Fast® Military Specification Ties

The following cable ties meet the stringent requirements of military specifications. To locate ties that meet a particular specification, refer to the chart below.

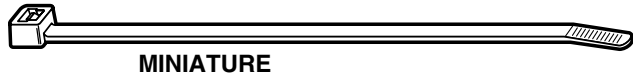

MINIATURE

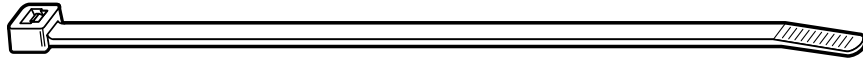

INTERMEDIATE

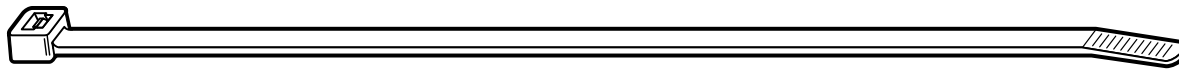

STANDARD

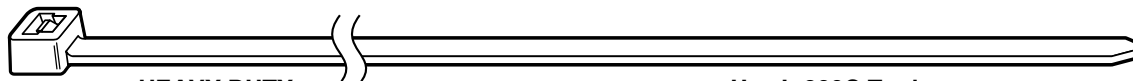

HEAVY DUTY

Use L-300C Tool



Mil-Spec Cable Ties

Mil-Spec	Std. Cat. No.	Bulk Cat. No.	Material	ID Code	Tool Setting	Std. Pkg.	Bulk Pkg.
MS-3367-2-9	L-14-50-9-C	L-14-50-9-D	Natural Nylon	STD	6 to 8	100	500
MS-3367-2-0	L-14-50-0-C	L-14-50-0-D	UV Black Nylon	STD	6 to 8	100	500
MS-3367-3-9	L-14-120-9-C	–	Natural Nylon	HVY	5 to 8	100	–
MS-3367-3-0	L-14-120-0-C	–	UV Black Nylon	STD	6 to 8	100	–
MS-3367-4-9	L-4-18-9-C	–	Natural Nylon	MIN	1 to 3	100	–
MS-3367-4-0	L-4-18-0-C	–	UV Black Nylon	MIN	1 to 3	100	–
MS-3367-5-9	L-5-30-9-C	–	Natural Nylon	INT	3 to 5	100	–
MS-3367-5-0	L-5-30-0-C	–	UV Black Nylon	INT	3 to 5	100	–
MS-3367-7-9	L-11-50-9-C	L-11-50-9-D	Natural Nylon	STD	6 to 8	100	500
MS-3367-7-0	L-11-50-0-C	L-11-50-0-D	UV Black Nylon	STD	6 to 8	100	500
MS-3367-6-9	L-28-120-9-L	–	Natural Nylon	HVY	5 to 8	50	–
MS-3367-6-0	L-28-120-0-L	–	UV Black Nylon	HVY	5 to 8	50	–

• Use L-200, L-400-C, or ERG-297 Installation Tools

• Ty-Fast® FSCM 65664 QPL Listed

• **UL File No. E151267**
*Electrical Construction Materials
Spiral Wrap*

• **UL File No. E132609**
Wire Connectors

• **UL File No. E107819**
*Fabricated Parts
Fasteners and Hardware for
Material Traceability*

To assure that military labeling requirements are met when ordering MIL-SPEC Cable Ties, please reference the desired MS number when ordering.

Sample Catalog Order:

L 4 18 9 C = Natural Color Type

Color Table

0 – Black (Outdoor)	5 – Green	11 – Fluorescent Pink
1 – Brown	6 – Blue	16 – Fluorescent Orange
2 – Red	7 – Purple	17 – Fluorescent Yellow
3 – Orange	8 – Gray	18 – Fluorescent Green
4 – Yellow	9 – Natural	20 – Fluorescent Blue

Thomas & Betts

Ty-Fast®

Cable Ties

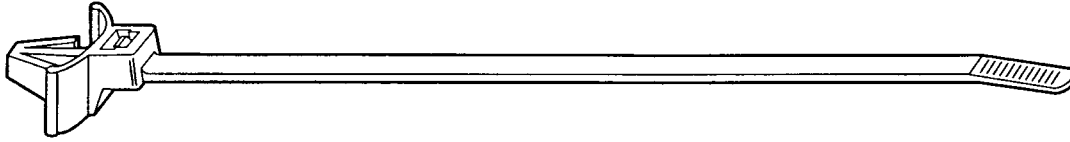

Push Mount Cable Ties

Std. Cat. No.	Cat. No. Bulk	Tie Color	Stripe Color	Bundle Diameter		Length		Width		Minimum Loop Tensile		Std. Pkg.	Bulk Pkg.
				Inch	(mm)	Inch	(mm)	Inch	(mm)	LB	(kg)		
L-5-50PM-9-C	L-5-50PM-9-D	Nylon	Natural	1/16 - 1	(2-25)	5.8	(147)	.187	(4.76)	50	(22.7)	100	500
L-5-50PM-0-C	L-5-50PM-0-D	Nylon	Black	1/16 - 1	(2-25)	5.8	(147)	.187	(4.76)	50	(22.7)	100	500
L-7-50PM-9-C	L-7-50PM-9-D	Nylon	Natural	1/16 - 1 3/4	(2-44)	8.2	(208)	.187	(4.76)	50	(22.7)	100	500
L-7-50PM-0-C	L-7-50PM-0-D	Nylon	Black	1/16 - 1 3/4	(2-44)	8.2	(208)	.187	(4.76)	50	(22.7)	100	500

- For use in .250 mounting hole.
- Maximum panel thickness .105.

Consult Customer Service for availability and colors.

Releasable Push Mount Cable Ties

Std. Cat. No.	Cat. No. Bulk	Tie Color	Stripe Color	Bundle Diameter		Length		Width		Minimum Loop Tensile		Std. Pkg.	Bulk Pkg.
				Inch	(mm)	Inch	(mm)	Inch	(mm)	LB	(kg)		
L-5-50PMR-9-C	L-5-50PMR-9-D	Nylon	Natural	1/16 - 1	(2-25)	5.8	(147)	.187	(4.76)	50	(22.7)	100	500
L-5-50PMR-0-C	L-5-50PMR-0-D	Nylon	Black	1/16 - 1	(2-25)	5.8	(147)	.187	(4.76)	50	(22.7)	100	500
L-7-50PMR-9-C	L-7-50PMR-9-D	Nylon	Natural	1/16 - 1 3/4	(2-44)	8.2	(208)	.187	(4.76)	50	(22.7)	100	500
L-7-50PMR-0-C	L-7-50PMR-0-D	Nylon	Black	1/16 - 1 3/4	(2-44)	8.2	(208)	.187	(4.76)	50	(22.7)	100	500

- For use in .250 mounting hole.
- Maximum panel thickness .105.

Consult Customer Service for availability and colors.

Ty-Rap®/Ty-Fast®

Thomas & Betts

Ty-Fast® Cable Ties

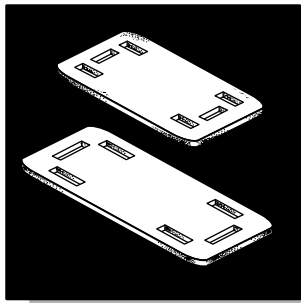

- Two tags for marking bundles to 9" diameters.
- Run ties through opposing mounting holes lengthwise or across the height of tags.
- IDNY-1500 accepts ties to 50 pound tensile; IDNY-2000 accepts ties to 120 pound tensile.
- Stocked in 6/6 Natural Nylon.
- UL Flammability 94 V-2.
- Non-Conductive, Non-Corrosive; resistant to fuels, lubricants and most chemicals.

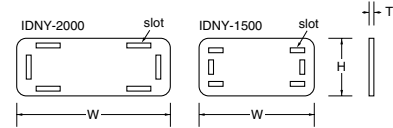

Identification Tags

Std. Cat. No.	Bulk Cat. No.	H Height		W Width		T Thickness		Slot Height		Slot Width		Std. Pkg.	Bulk Pkg.
		Inch	(mm)	Inch	(mm)	Inch	(mm)	Inch	(mm)	Inch	(mm)		
-	IDNY-1500-9-M	.745	(18.92)	1.500	(38.08)	.015	(.381)	.090	(2.29)	.200	(5.08)	-	1000
-	IDNY-2000-9-M	.745	(18.92)	2.000	(50.78)	.025	(.653)	.113	(2.87)	.336	(8.53)	-	1000
Tolerance ±		.015	(.381)	.030	(.762)	.005	(.127)	-	.010	(.254)	-	-	-

• Matte finish for sharp legends.
Consult Customer Service for availability and colors.

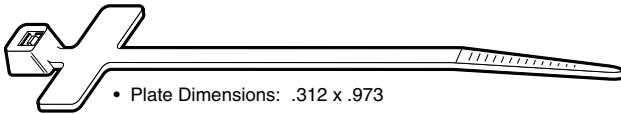

Identification Ties

Std. Cat. No.	Bulk Cat. No.	Material	Color	Max. Bundle Diameter		Length		Width		Minimum Loop Tensile		Std. Pkg.	Bulk Pkg.
				Inch	(mm)	Inch	(mm)	Inch	(mm)	LB	(kg)		
L-4-18ID-9-C	L-4-18ID-9-M	Nylon	Natural	¾	(19)	4.0	(102)	.100	(2.54)	18	(8.2)	100	1000

• Use QC-100, L-200 or L-400-C Installation Tool.
Consult Customer Service for availability and colors.

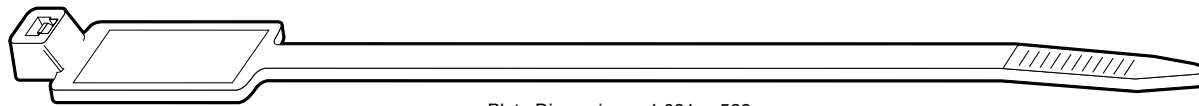

Std. Cat. No.	Bulk Cat. No.	Material	Color	Max. Bundle Diameter		Length		Width		Minimum Loop Tensile		Std. Pkg.	Bulk Pkg.
				Inch	(mm)	Inch	(mm)	Inch	(mm)	LB	(kg)		
L-7-50ID-9-C	L-7-50ID-9-M	Nylon	Natural	1¾	(44)	7.875	(200)	.183	(4.65)	50	(22.7)	100	1000

• Use QC-100, L-200 or L-400-C Installation Tool.
Consult Customer Service for availability and colors.



Marking Pens

Cat. No.	Color Ink	Std. Pkg.
WT163M-1	Black Marking Pen	1
WT163M-3	Red Marking Pen	1

Thomas & Betts

Ty-Fast®

Cable Ties



• Striped ties are used to identify wire in bundles.

Striped Ties

Std. Cat. No.	Tie Color	Stripe Color	Diameter		Length		Width		Loop Tensile		Std. Pkg.
			Inch	(mm)	Inch	(mm)	Inch	(mm)	LB	(kg)	
L-4-18-1/10-L	Brown	White	1/16 - 7/8	(2 - 16)	4.0	(102)	.100	(3)	18	(8.2)	50
L-4-18-1/2-L	Brown	Red	1/16 - 7/8	(2 - 16)	4.0	(102)	.100	(3)	18	(8.2)	50
L-4-18-1/0-L	Brown	Black	1/16 - 7/8	(2 - 16)	4.0	(102)	.100	(3)	18	(8.2)	50
L-4-18-1/4-L	Brown	Yellow	1/16 - 7/8	(2 - 16)	4.0	(102)	.100	(3)	18	(8.2)	50
L-4-18-1/7-L	Brown	Purple	1/16 - 7/8	(2 - 16)	4.0	(102)	.100	(3)	18	(8.2)	50
L-4-18-3/10-L	Orange	White	1/16 - 7/8	(2 - 16)	4.0	(102)	.100	(3)	18	(8.2)	50
L-4-18-3/2-L	Orange	Red	1/16 - 7/8	(2 - 16)	4.0	(102)	.100	(3)	18	(8.2)	50
L-4-18-3/0-L	Orange	Black	1/16 - 7/8	(2 - 16)	4.0	(102)	.100	(3)	18	(8.2)	50
L-4-18-3/4-L	Orange	Yellow	1/16 - 7/8	(2 - 16)	4.0	(102)	.100	(3)	18	(8.2)	50
L-4-18-3/7-L	Orange	Purple	1/16 - 7/8	(2 - 16)	4.0	(102)	.100	(3)	18	(8.2)	50
L-4-18-5/10-L	Green	White	1/16 - 7/8	(2 - 16)	4.0	(102)	.100	(3)	18	(8.2)	50
L-4-18-5/2-L	Green	Red	1/16 - 7/8	(2 - 16)	4.0	(102)	.100	(3)	18	(8.2)	50
L-4-18-5/0-L	Green	Black	1/16 - 7/8	(2 - 16)	4.0	(102)	.100	(3)	18	(8.2)	50
L-4-18-5/4-L	Green	Yellow	1/16 - 7/8	(2 - 16)	4.0	(102)	.100	(3)	18	(8.2)	50
L-4-18-5/7-L	Green	Purple	1/16 - 7/8	(2 - 16)	4.0	(102)	.100	(3)	18	(8.2)	50
L-4-18-6/10-L	Blue	White	1/16 - 7/8	(2 - 16)	4.0	(102)	.100	(3)	18	(8.2)	50
L-4-18-6/2-L	Blue	Red	1/16 - 7/8	(2 - 16)	4.0	(102)	.100	(3)	18	(8.2)	50
L-4-18-6/0-L	Blue	Black	1/16 - 7/8	(2 - 16)	4.0	(102)	.100	(3)	18	(8.2)	50
L-4-18-6/4-L	Blue	Yellow	1/16 - 7/8	(2 - 16)	4.0	(102)	.100	(3)	18	(8.2)	50
L-4-18-6/7-L	Blue	Purple	1/16 - 7/8	(2 - 16)	4.0	(102)	.100	(3)	18	(8.2)	50
L-4-18-8/10-L	Gray	White	1/16 - 7/8	(2 - 16)	4.0	(102)	.100	(3)	18	(8.2)	50
L-4-18-8/2-L	Gray	Red	1/16 - 7/8	(2 - 16)	4.0	(102)	.100	(3)	18	(8.2)	50
L-4-18-8/0-L	Gray	Black	1/16 - 7/8	(2 - 16)	4.0	(102)	.100	(3)	18	(8.2)	50
L-4-18-8/4-L	Gray	Yellow	1/16 - 7/8	(2 - 16)	4.0	(102)	.100	(3)	18	(8.2)	50
L-4-18-8/7-L	Gray	Purple	1/16 - 7/8	(2 - 16)	4.0	(102)	.100	(3)	18	(8.2)	50

- Also available in bulk packages of 1000.
 - Use QC-100, L-200, L-400-C, or ERG-299 Installation Tool.
- Consult Customer Service for availability and colors.

Ty-Rap®/Ty-Fast®

Thomas & Betts

Ty-Fast[®] Cable Ties

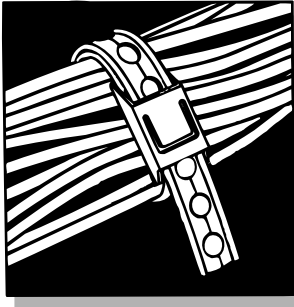

- Extruded in 5 widths with 8 mounting hole diameters for use with a variety of standard and custom fasteners.
- Extrusion grade Black Nylon.
- Hole spacing allows for greater flexibility in meeting bundle diameter requirements.
- Strapping provides a wide range of tensile strengths depending on mounting method (S2NY-096-0 tested at 50 lbs. with BTNY-096).
- Non-Conductive, Non Corrosive; resistant to fuels, lubricants and most chemicals.

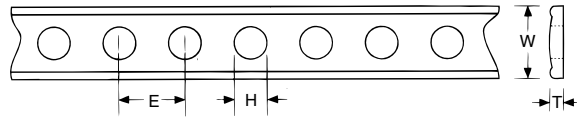

Strapping

Item Number	W Width		T Thickness		H Hole		E Spacing		Quantity
	Inch	(mm)	Inch	(mm)	Inch	(mm)	Inch	(mm)	
S2NY-096-0-C	.281	(7.13)	.032	(.813)	.096	(2.44)	.187	(4.75)	100 foot rolls
S4NY-128-0-C	.375	(9.52)	.040	(1.02)	.128	(3.25)	.312	(7.92)	100 foot rolls
S4NY-140-0-C	.375	(9.52)	.040	(1.02)	.140	(3.56)	.312	(7.92)	100 foot rolls
S4NY-167-0-C	.375	(9.52)	.040	(1.02)	.167	(4.24)	.312	(7.92)	100 foot rolls
S4NY-167X-0-C	.375	(9.52)	.040	(1.02)	.167	(4.24)	.218	(5.54)	100 foot rolls
S6NY-000-0-C	.500	(12.70)	.060	(1.52)	N/A	N/A	N/A	N/A	100 foot rolls
S6NY-167-0-C	.500	(12.70)	.060	(1.52)	.167	(4.24)	.390	(9.90)	100 foot rolls
S6NY-203-0-C	.500	(12.70)	.060	(1.52)	.203	(5.16)	.390	(9.90)	100 foot rolls
S6NY-203X-0-C	.500	(12.70)	.060	(1.52)	.203	(5.16)	.281	(7.14)	100 foot rolls
S7NY-265-0-C	.625	(15.87)	.070	(1.78)	.265	(6.73)	.500	(12.70)	100 foot rolls
S7NY-265X-0-C	.625	(15.87)	.070	(1.78)	.265	(6.73)	.375	(9.52)	100 foot rolls
S7NY-281-0-C	.625	(15.87)	.070	(1.78)	.281	(7.14)	.500	(12.70)	100 foot rolls
S9NY-000-0-C	.875	(22.22)	.070	(1.78)	N/A	N/A	N/A	N/A	100 foot rolls
S9NY-203-0-C	.875	(22.22)	.070	(1.78)	.203	(5.16)	.500	(12.70)	100 foot rolls
S9NY-265-0-C	.875	(22.22)	.070	(1.78)	.265	(6.73)	.500	(12.70)	100 foot rolls
S9NY-390-0-C	.875	(22.22)	.070	(1.78)	.390	(9.90)	.625	(15.87)	100 foot rolls

Strapping Accessories Reference

Strapping Number	Strap-Tite Buckle	Mounting Tab	Mounting Cradle	Stud Buttons	Machine Screw
S2NY-096-0-C	N/A	M4NY-203-0-D	C4NY-203-0-D	BTNY-096-0-D	#2
S4NY-128-0-C	N/A	M4NY-203-0-D	C4NY-203-0-D	N/A	#5
S4NY-140-0-C	N/A	M4NY-203-0-D	C4NY-203-0-D	N/A	#6
S4NY-167-0-C	B4NY-167-0-D	M4NY-203-0-D	C4NY-203-0-D	BTNY-167-0-D	#8
S4NY-167X-0-C	B4NY-167-0-D	M4NY-203-0-D	C4NY-203-0-D	BTNY-167-0-D	#8
S6NY-000-0-C	N/A	M6NY-265-0-D	N/A	N/A	N/A
S6NY-167-0-C	N/A	M6NY-265-0-D	N/A	N/A	#8
S6NY-203-0-C	B6NY-203-0-D	M6NY-265-0-D	N/A	BTNY-203-0-D	#10
S6NY-203X-0-C	B6NY-203-0-D	M6NY-265-0-D	N/A	BTNY-203-0-D	#10
S7NY-265-0-C	B7NY-265-0-D	M7NY-328-0-D	N/A	BTNY-265-0-D	#¼
S7NY-265X-0-C	B7NY-265-0-D	M7NY-328-0-D	N/A	BTNY-265-0-D	#¼
S7NY-281-0-C	N/A	M7NY-328-0-D	N/A	N/A	#¼
S9NY-203-0-C	N/A	N/A	N/A	BTNY-203-0-D	#10
S9NY-265-0-C	N/A	N/A	N/A	BTNY-265-0-D	#¼
S9NY-390-0-C	N/A	N/A	N/A	N/A	#¾

Thomas & Betts

Ty-Fast® Cable Ties

Ty-Fast® Cable Ties Industrial Jar



90457-I and 90650-IUV

Features:

- Ties available in natural nylon or black weather-resistant nylon.
- Reusable jar.
- Easily merchandised.
- Great value.
- UL Recognized and Mil-Spec Approved.

CAT-PAK® CABLE TIE ASSORTMENTS

- Four Styles in Convenient Resealable Bags
- Natural or UV Black Nylon
- Point-of-Purchase Display

UL RECOGNIZED

Item Number	Contents	Material	Bags/Case
CAT-711	100 L-7-50-9	Natural Nylon	25
	50 L-11-60-9		
CAT-4811	100 L-4-18-9		35
	100 L-8-40-9		
	50 L-11-50-9		
CAT-5811	200 L-5-30-9		30
	200 L-8-40-9		
	50 L-11-50-9		

• For UV Black Assortments, add "-B" to Item Number



Cat. No.	Material	Jar Qty.	Length (inches)	Width	Max. Bundle (inches)	Tensile Strength	Pallet Qty.		
							Mini	Full	
90457-I		Natural Nylon	200	4	.100	5# (6.25)	18#	240	400
			100	5.6	.130	1¼ (1.25)	30#	240	400
			200	7.5	.187	1¾ (1.75)	50#	240	400
90457-IUV		Black Weather-Resistant Nylon	200	4	.100	5# (6.25)	18#	240	400
			100	5.6	.130	1¼ (1.25)	30#	240	400
			200	7.5	.187	1¾ (1.75)	50#	240	400
90650-I		Natural Nylon	300	4	.100	5# (6.25)	18#	160	320
			300	7.5	.187	1¾ (1.75)	50#	160	320
			50	11.1	.187	3	50#	160	320
90650-IUV		Black Weather-Resistant Nylon	300	4	.100	5# (6.25)	18#	160	320
			300	7.5	.187	1¾ (1.75)	50#	160	320
			50	11.1	.187	3	50#	160	320



Ty-Fast®

Low Profile In-Line Fasteners



Low profile contoured head compared with the profile of the traditional Ty-Fast® Cable Tie.

This fastener design from Thomas & Betts is ideal for use where precision bundling is required and clearance is a necessity. A unique saddle back design curves to form a snug fit around the bundle, and allows for easy pull-through in bulkheads and any other tight spaces. Our contoured head eliminates snagging and sharp edges are reduced by our safe-guard walls.

Features

- Low-profile, contoured head reduces clearance required for the bundle and enhances the appearance of your harness.
- The safe-guard wall eliminates exposure to sharp edges.
- The saddle back fits snug against the contour of the wiring harness.
- Sizes and colors available to accommodate varying requirements.
- High-quality nylon strength.

Cable Ties Ordering Information

Std. Cat. No.	Bundle Range Dia. In. (mm)	Tensile Strength Lbs.(Kg)	Tie Length In (mm)	Strap Width In (mm)	Strap Thick In (mm)	Std. Pkg.	Bulk. Pkg.
SF100-18	.125–1.00 (3.17–25.4)	18 (8.16)	4.65 (118.11)	.095 (2.41)	.043 (1.09)	100	1000
SF150-18	.125–1.50 (3.17–38.1)	18 (8.16)	6.45 (163.83)	.095 (2.41)	.043 (1.09)	100	1000
SF200-18	.125–2.00 (3.17–50.8)	18 (8.16)	8.10 (205.74)	.095 (2.41)	.043 (1.09)	100	1000
SF175-50	.187–1.75 (4.74–44.4)	50 (22.68)	7.70 (195.58)	.187 (4.74)	.048 (1.21)	100	1000
SF300-50	.187–3.00 (4.74–76.2)	50 (22.68)	11.33 (287.78)	.187 (4.74)	.052 (1.32)	100	1000
SF400-50	.187–4.00 (4.74–101.6)	50 (22.68)	14.53 (369.06)	.187 (4.74)	.052 (1.32)	100	1000
SF400-120	.375–4.00 (9.52–101.6)	120 (54.43)	14.58 (370.33)	.300 (7.62)	.075 (1.90)	100	1000
SF600-120	.375–6.00 (9.52–152.4)	120 (54.43)	21.00 (533.40)	.300 (7.62)	.075 (1.90)	100	1000
ERG297	Application tool for 50 lbs. to 120 lbs. tensile strength						
ERG299	Application tool for 18 lbs. to 50 lbs. tensile strength						

Material: Natural Nylon 6/6 in accordance with ASTM D4066 PA111. Also available in black outdoor weatherable (suffix "-X").
Dimensions: Designed according to military standards (MS3367) except for the head length, which is slightly larger than MIL spec.
Packaging: Standard package is 1000 pieces.

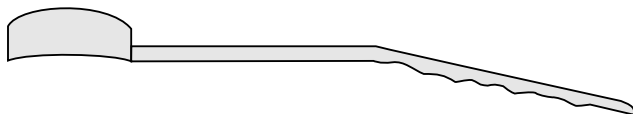
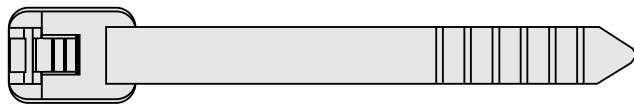

How to Order Color Cable Ties

Color	Suffix No.
Black (outdoor)	X
Brown	1
Red	2
Orange	3
Yellow	4
Green	5
Blue	6
Purple	7
Gray	8
White	9

Packaged for handling convenience.

Natural nylon is standard. For colored Safe-Ty in-line fasteners add the following suffix numbers to catalog numbers. Example: **SF175-50-2** (Red)
For Distributor Packs (100), add suffix "-100".

Example: **SF175-50-100**

(Consult customer service for ordering information)

Thomas & Betts

Ty-Fast® Badge Holder



Ty-Fast® Badge Holder

The ticket fastener that won't leave you out in the cold.

Thomas & Betts offers ski resorts a convenient, low-cost, quick, and safe alternative to the metal wire clip currently used to attach ski lift tickets to skiers' clothing.

Ty-Fast® Badge Holder offers these prominent advantages:

- Designed specifically for lift ticket attachment to prevent damage to skier's clothing.
- Incorporates a loop diameter restriction device that forms the proper sized 1¼-inch loop required to hold the lift ticket in place and lay flat on the skier.
- Prevents the tie from being over-tightened and damaging the lift ticket.
- May also serve to aid the skier in zipping their coat by extending the zipper length.
- The Badge Holder is tamper resistant and smooth up to the restriction point to keep it from being shared or reused by other skiers.
- The smooth body eliminates the notch sensitivity issue inherent to all-nylon cable ties.
- The Badge Holder is designed with a flexible short round tail, safely eliminating sharp metal.
- Affordable at just pennies per fastener!

The Badge Holder comes in 9 different colors to match the resort's color schemes and is made of high quality Nylon 6/6 material to withstand cold temperatures. It is 5 inches long and has a sturdy 30 pound tensile strength rating. Badge Holders may also be heat-stamped with additional identification, such as the resort's name or web site.

When the snow starts, Badge Holders will be ready to keep things snug, all the way down the mountain!



Ty-Fast® Badge Holder Ordering Information

Cat No.	Description	Qty.	UPC
SJ-5-30SKI-9-M	Ticket Fastener	1000 bag	786210-17017

Natural nylon color. Please consult Customer Service for ordering and availability of colors and heat-stamping.

Dimensions: 5"
Construction: Nylon 6/6
Max. Tensile Strength: 30 lbs.

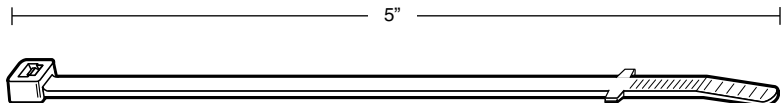

Thomas & Betts

Thomas & Betts

Cable Tie Mounting Bases

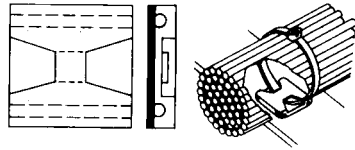

TC5342A

This nylon base is neutral in color, and for indoor use.

Holes for no. 8 screws

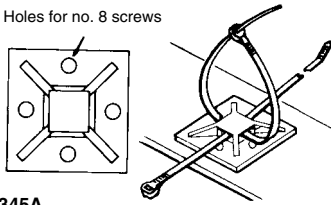

TC5345A

Accepting cable ties in four directions at 90°, this nylon, adhesive-backed base has two advantages. It eliminates errors in premounting the base with respect to its orientation to wire bundle direction. It also is a convenient way to mount wire bundles at cross-over points. Four optional mounting holes are included.

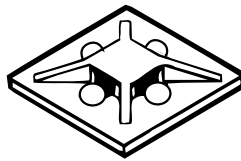

TC5344A

The four-way, pressure-sensitive, adhesive mounting base for use on cable ties up to .140 maximum width.

Hole for no. 6 screw

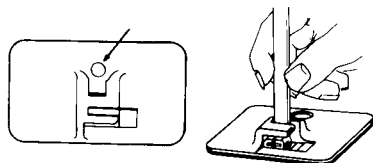

TC5353A

Mounting bases (adhesive backed, epoxy or screws)

Thomas & Betts has a mounting base or clamp to suit most applications and cable tie widths. For easier installation, some bases are available with pressure sensitive adhesive tape.

Features

- Available in a variety of materials for both indoor and outdoor use.
- One-piece molding – no loss of parts.
- Adhesive backed with pressure sensitive adhesive tape (where applicable).

Ordering Information

Adhesive Mounting Bases

Std. Cat. No.	Bulk Cat. No.	Mounting Method	Max. Tie Width Accom.	Length (in.)	Width (in.)	Material	Std. Pkg.	Bulk Pkg.
TC5342A	TC342A	Adhesive	.190	1.125	1.125	Nylon 6/6	100	1000
-	TC342A-X	Adhesive	.190	1.125	1.125	Weatherable nylon	-	1000
-	TC342	TC2PA	.190	1.125	1.125	Nylon 6/6	-	1000
-	TC342X	TC2PA	.190	1.125	1.125	Weatherable nylon	-	1000
-	TC342A-FR	Adhesive	.190	1.125	1.25	Flame-retardant nylon	-	1000

Four-Way Adhesive Mounting Base

Std. Cat. No.	Bulk Cat. No.	Mounting Method	Max. Tie Width Accom.	Length (in.)	Width (in.)	Material	Std. Pkg.	Bulk Pkg.
TC5345A	TC345A	Adhesive	.190	1.125	1.125	Nylon 6/6	100	1000
-	TC345AFR	Adhesive	.190	1.125	1.125	Flame-retardant	-	1000
-	TC345AX	Adhesive	.190	1.125	1.125	Weatherable nylon	-	1000
-	TC345	TC2PA/Screws	.190	1.125	1.125	Nylon 6/6	-	1000

Larger Size Four-Way Mini Base

Std. Cat. No.	Bulk Cat. No.	Mounting Method	Size (in.)	Material
TC050X050A	TC050X050A-C	Adhesive Backed	0.5 x 0.5	Nylon 6/6
TC150X150	TC150X150-L	Screw Mount	1.50 x 1.50	Nylon 6/6
TC150X150A	TC150X150A-L	Adhesive Backed	1.50 x 1.50	Nylon 6/6
TC200X200	TC200X200-L	Screw Mount	2.0 x 2.0	Nylon 6/6
TC200X200A	TC200X200A-L	Adhesive Backed	2.0 x 2.0	Nylon 6/6

Four-Way Mini Base

Std. Cat. No.	Bulk Cat. No.	Mounting Method	Max. Tie Width Accom.	Length (in.)	Width (in.)	Material	Std. Pkg.	Bulk Pkg.
TC5344A	TC344A	Adhesive	.140	.750	.750	Nylon 6/6	100	1000
TC5344AX	TC344AX	Adhesive	.140	.750	.750	Weatherable Nylon	100	1000

Flexible Adhesive Base for Preassembled Ties

Std. Cat. No.	Bulk Cat. No.	Mounting Method	Max. Tie Width Accom.	Length (in.)	Width (in.)	Material	Std. Pkg.	Bulk Pkg.
TC5353A	TC353A	Adhesive	.190	2.000	1.000	Nylon 6/6	25	500
-	TC353	TC2PA/Screws	.190	2.000	1.000	Nylon 6/6	-	500

Thomas & Betts

Thomas & Betts

Cable Tie Mounting Bases

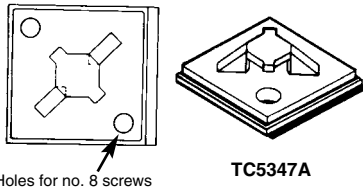

Holes for no. 8 screws

TC5347A

The TC347 series is a versatile base which accommodates the entire line of standard cable ties. It is a four-way base for cable ties up to .184 maximum width, and a two-way base for ties up to .301 maximum width. It may also be mounted with #8 size screw (2 holes).

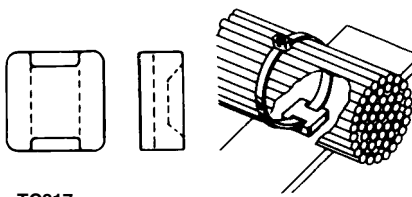

TC817

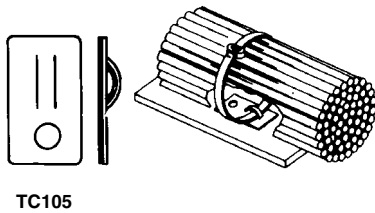

TC105

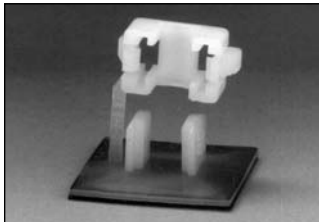

- Provides a fast and convenient method of securing bundles.
- Single piece design offers reduced installation time and maximized inventory control.
- Integral top cover incorporates a unique ratchet design that is fully adjustable and releasable.
- Available in a pressure sensitive adhesive or screw mount design.



Adhesive Mounting Base

Std. Cat. No.	Bulk Pkg. Cat. No.	Mounting Method	Max. Tie Width Accom.	Length (in.)	Width (in.)	Material	Std. Pkg.	Bulk Pkg.
TC5347A	TC347A	Adhesive	.301	1.125	1.125	Nylon 6/6	100	1000
-	TC347	TC2PA/Screws	.301	1.125	1.125	Nylon 6/6	-	1000
-	TC347FR	TC2PA/Screws	.301	1.125	1.125	Flame-retardant	-	1000
-	TC347X	TC2PA/Screws	.301	1.125	1.125	Weatherable nylon	-	1000
-	TCZ347	TC2PA/Screws	.301	1.125	1.125	Tefzel	-	1000

Miniature Base

Std. Cat. No.	Bulk Pkg. Cat. No.	Mounting Method	Max. Tie Width Accom.	Length (in.)	Width (in.)	Material	Std. Pkg.	Bulk Pkg.
-	TC817-TB	TC2PA	.190	.437	.437	Nylon 6/6	-	1000

Aluminum Adhesive Mounting Plates

Std. Cat. No.	Bulk Pkg. Cat. No.	Mounting Method	Max. Tie Width Accom.	Length (in.)	Width (in.)	Material	Std. Pkg.	Bulk Pkg.
-	TC105	TC2PA	.190	1.000	.500	Aluminum	-	1000
-	TC824-TB	TC2PA	.190	1.375	.375	Aluminum	-	1000

Note: For adhesive back bases temperature rating is -0°F to +120°F

One-Piece Mounting Clamp

Cat. No.	Base Style	Maximum Height	Clamping Area		Std. Pkg.		
			Minimum	Maximum			
TC349A-TB	Adhesive	0.57" (14.5mm)	0.18" x 0.24" (4.5mm x 6.0mm)		1000		
TC5349A-TB	Adhesive					.035" x 0.24" (9.0mm x 6.0mm)	
TC350-TB	Screw Mount	0.89" (22.5mm)	0.20" x 0.59" (5.0mm x 15.0mm)		1000		
TC350A-TB	Adhesive					0.45" x 0.59" (11.5mm x 15.0mm)	
TC5350A-TB	Adhesive						

Note: Made of natural nylon 6/6.
 Temperature Range: -40°C to +85°
 Classified to U.L.94V-2.
 Product Base is .94" (25.0 mm) x .94" (25.0 mm).
 Utilizes #8 self-tapping screw for mounting the TC350-TB.

Mounting Base Adhesive

Cat. No.	Description	Std. Pkg.
TC2PA	Consists of one tube each adhesive and activator	1

Thomas & Betts

Ty-Rap®/Ty-Fast®

Thomas & Betts

Cable Tie Mounting Bases

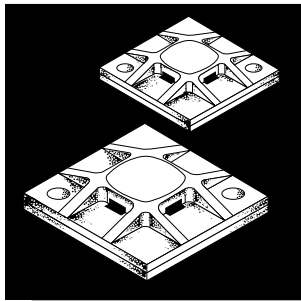

Mounting Pads

- 3/4" and 1" mounts for use with 18# through 50# tensile cable ties.

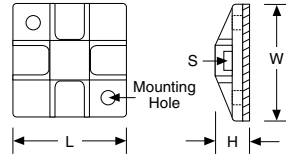

- Supplied on rubber based (synthetic polymer) closed cell foam adhesive on acrylic based adhesive, or with no adhesive for #6 screw mount applications.
- Available in 6/6 Natural Nylon and heat stabilized 6/6 Black Nylon.
- UL Flammability 94 V-2 (clip).



3/4" x 3/4" Mount

Std. Cat. No.	Bulk Cat. No.	Material	Mount Method	Height		Length		Width		Slot Height		Slot Width		Std. Pkg.	Bulk Pkg.
				Inch	(mm)	Inch	(mm)	Inch	(mm)	LB	(kg)	Inch	(mm)		
MPNY-750-9-C	MPNY-750-9-D	Natural Nylon	Synthetic Polymer	.205	(5.21)	.750	(19.04)	.750	(19.04)	.050	(1.27)	.140	(3.18)	100	500
MPNY-750-0-C	MPNY-750-0-D	Black Nylon	Synthetic Polymer	.205	(5.21)	.750	(19.04)	.750	(19.04)	.050	(1.27)	.140	(3.18)	100	500
MPNY-750A-9-C	MPNY-750A-9-D	Natural Nylon	Acrylic Adhesive	.205	(5.21)	.750	(19.04)	.750	(19.04)	.050	(1.27)	.140	(3.18)	100	500
MPNY-750A-0-C	MPNY-750A-0-D	Black Nylon	Acrylic Adhesive	.205	(5.21)	.750	(19.04)	.750	(19.04)	.050	(1.27)	.140	(3.18)	100	500
MPNY-750S-9-C	MPNY-750S-9-D	Natural Nylon	#6 Screw	.205	(5.21)	.750	(19.04)	.750	(19.04)	.050	(1.27)	.140	(3.18)	100	500
MPNY-750S-0-C	MPNY-750S-0-D	Black Nylon	#6 Screw	.205	(5.21)	.750	(19.04)	.750	(19.04)	.050	(1.27)	.140	(3.18)	100	500
Tolerance ±				.010	(.254)	.015	(.381)			.010	(.254)				

For use with 18-40 lb. Cable Ties.



1" x 1" Mount

Std. Cat. No.	Bulk Cat. No.	Material	Mount Method	H Height		L Length		W Width		S Slot Height		S Slot Width		Std. Pkg.	Bulk Pkg.
				Inch	(mm)	Inch	(mm)	Inch	(mm)	LB	(kg)	Inch	(mm)		
MPNY-1000-9-C	-	Natural Nylon	Synthetic Polymer	.215	(5.46)	1.000	(25.40)	1.000	(25.40)	.070	(1.78)	.203	(5.16)	100	-
MPNY-1000-0-C	-	Black Nylon	Synthetic Polymer	.215	(5.46)	1.000	(25.40)	1.000	(25.40)	.070	(1.78)	.203	(5.16)	100	-
MPNY-1000A-9-C	-	Natural Nylon	Acrylic Adhesive	.215	(5.46)	1.000	(25.40)	1.000	(25.40)	.070	(1.78)	.203	(5.16)	100	-
MPNY-1000A-0-C	-	Black Nylon	Acrylic Adhesive	.215	(5.46)	1.000	(25.40)	1.000	(25.40)	.070	(1.78)	.203	(5.16)	100	-
MPNY-1000S-9-C	MPNY-1000S-9-D	Natural Nylon	#6 Screw	.215	(5.46)	1.000	(25.40)	1.000	(25.40)	.070	(1.78)	.203	(5.16)	100	1000
MPNY-1000S-0-C	MPNY-1000S-0-D	Black Nylon	#6 Screw	.215	(5.46)	1.000	(25.40)	1.000	(25.40)	.070	(1.78)	.203	(5.16)	100	1000
Tolerance ±				.010	(.254)	.015	(.381)			.010	(.254)				

For use with 18-50 lb. Cable Ties.

- **Mounting Surface should be cleaned with alcohol based (IPA) cleaner before application.**
- **Acrylic Based may be repositioned initially. Allow 24-72 hours set-up for maximum performance with Acrylic Based adhesives.**
- **For rubber based, allow 15 minutes set-up for maximum performance.**



Ty-Rap®/Ty-Fast®

Thomas & Betts

Cable Tie Mounting Bases

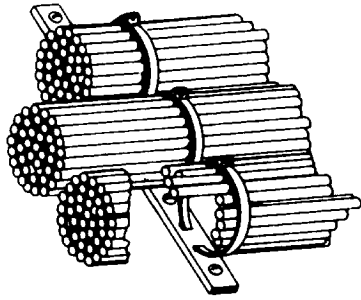

Multiple-Bundle Mounting Strips

Bulk Cat. No.	Mounting Method	Maximum Tie Width Accom.	Width (in.)	Length (in.)	Capacity (bundles)	Mil. Std. Part No.	Bulk Pkg.
TC1101	#6 screws	.190	.500	1.75	1	MS3339-1	100
TC1102	#6 screws	.190	.500	3.00	2	MS3339-2	100
TC1103	#6 screws	.190	.500	4.25	3	MS3339-3	100
TC1104	#6 screws	.190	.500	5.50	4	MS3339-4	100
TC1105	#6 screws	.190	.500	6.75	5	MS3339-5	100
TC1112	#6 screws	.301	.625	9.60	6	MS3339-11	100
TC1113	#6 screws	.301	.625	2.10	6	MS3339-6	100
TC1114	#6 screws	.301	.625	3.60	2	MS3339-7	100
TC1115	#6 screws	.301	.625	5.10	3	MS3339-8	100
TC1116	#6 screws	.301	.625	6.60	4	MS3339-9	100
TC1117	#6 screws	.301	.625	8.10	5	MS3339-10	100

These nylon mounting strips for parallel installation of wire bundles can accommodate up to six closely spaced bundles.

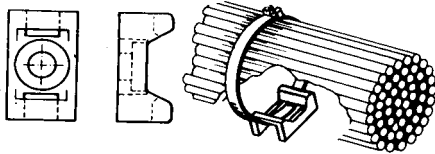

Saddle Support Base

Std. Cat. No.	Bulk Cat. No.	Mounting Method	Maximum Tie Width Accom.	Width (in.)	Length (in.)	Std. Pkg.	Bulk Pkg.
-	TC140	#4 Pan head	-	-	-	-	500
TC5141	TC141*	#6 Pan head	.190	.439	.672	100	500
TC5142	TC142	#10 Pan head	.301	.563	.922	100	500

This mounting base provides a saddle for the wire run. Ty-Rap® tie is threaded under bundle and tied in usual manner.
Note: For additional materials see Technical Services.

* Add suffix FR for flame retardant material. (TC141 only.)



Push-In and Bolted Bases

Std. Cat. No.	Bulk Cat. No.	Mounting Hole Size	Maximum Tie Width Accom.	Width (in.)	Length (in.)	Std. Pkg.	Bulk Pkg.
TC5823	TC823-TB	1/4	.190	.438	.625	100	1000
-	TC107†	#10-32 thd	.190	.438	.688	-	1000

† Not Ⓢ Recognized.



Snap-In Mounting Base Cap

Bulk Cat. No.	Mounting Hole Size	Maximum Tie Width Accom.	Width (in.)	Length (in.)	Material	Bulk Pkg.
TC121-TB	.250	.190	.445	.415	Nylon 6/6	1000
TCH121†	.250	.190	.445	.415	Nylon 6/6 heat stabilized	1000

Snap-in, premountable base for securing wire bundles in cabinets maintains the attractive external appearance of the equipment housing—TC121 Snap-Cap.

† Not Ⓢ Recognized.

Thomas & Betts

Thomas & Betts

Cable Tie Mounting Bases

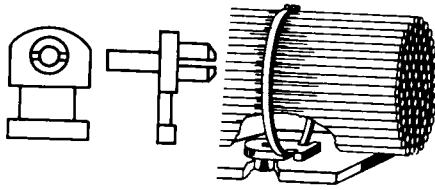

Self-Riveting Base

Bulk Cat. No.	Mounting Hole Size	Maximum Tie Width Accom.	Width (in.)	Length (in.)	Material	Bulk Pkg.
TC116-TB	.146	.190	.500	.750	Nylon 6/6 (Red)	1000
TC118-TB	.169	.190	.500	.750	Nylon 6/6 (Blue)	1000
TC120	.196	.190	.500	.750	Nylon 6/6 (Yellow)	1000

Knock-in mounting base TC116-TB, TC118-TB, TC120—firmly locks into position when projecting pin is knocked into hollow peg. Slip tie under base and tie as usual.

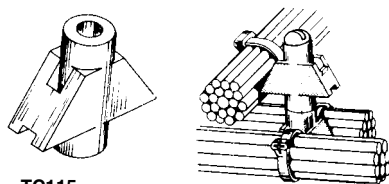

TC115

Ty-Rap® Mounting Blocks

Bulk Cat. No.	Mounting Bolt Size	Maximum Tie Width Accom.	Width (in.)	Length (in.)	Bulk Pkg.
TC115-TB	#10	.190	.469	1.00	1000

Mounting blocks permit vertical stacking and can be used in any direction.

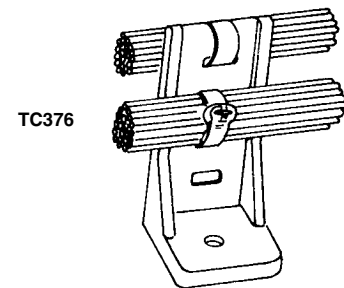

TC376

Ty-Rap® Stand-Off Brackets

Bulk Cat. No.	Maximum Tie Width Accom.	Width (in.)	Length (in.)	Bulk Pkg.
TC375	.190	.750	3.65	100
TC376	.190	.670	1.75	100

These brackets permit bundles to be mounted on either side. They also serve as means to raise bundles off the surface.

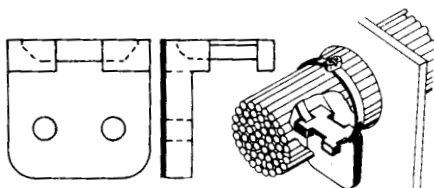

Right-Angle Bundle Support

Bulk Cat. No.	Maximum Tie Width Accom.	Width (in.)	Length (in.)	Bulk Pkg.
TC109	.190	.563	.438	200
TC106	.301	1.000	1.000	1000

This style meets Military Specification requirements as a support at holes in bulkheads and walls.

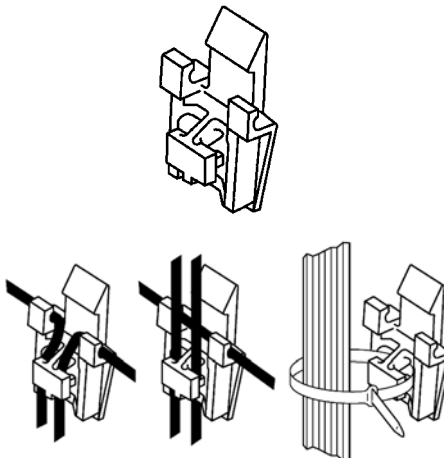

Aluminum Siding Clip

Cat. No.	Wire Accommodation	Bulk Pkg.
TC201	1/8" dia. wire (2 pair station wire)	

Material:

- Transparent – Color and texture of siding shows through.
- Material – Weather resistant grade polycarbonate.
- Designed to accommodate PITTSBURG INTERLOCK metal siding.
- Accommodates wires both vertically and/or horizontally.
- Provision for utilizing Ty-Rap® cable ties to secure large diameter bundles.

Ty-Rap®/Ty-Fast®

Thomas & Betts

Cable Tie Mounting Bases

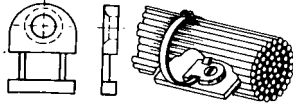
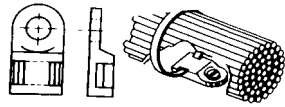

These miniature mounting bases are ideal for high-density packaging. Simply slip Ty-Rap® tie under slot in fastened mount, and complete tie in usual manner. Check chart for mounting details.

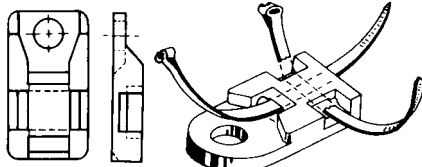

TC826-TB

TC826-TB

Ty-Rap®/Ty-Fast®

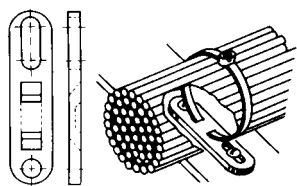
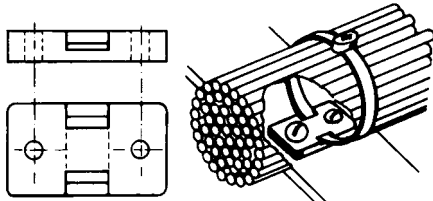

Miniature Mounting Bases

Std. Cat. No.	Bulk Pkg. Cat. No.	Mounting Method	Maximum Tie Width Accom.	Width (in.)	Length (in.)	Std. Pkg.	Bulk Pkg.
TC502	TC102	#8 screw	.190	.500	.750	100	1000
-	TC104	#5 screw	.091	.316	.406	-	1000
-	TC804	#2 screw	.091	.316	.406	-	1000
-	TC112-TB	#8 screw	.190	.375	.750	-	1000
-	TC812-TB	#10 screw	.190	.375	.750	-	1000
-	TC814-TB	#5 screw	.190	.375	.750	-	1000

Threaded insert permits screw to come from outside of mounting surface.

Two-Direction Mounting Base

Std. Cat. No.	Bulk Pkg. Cat. No.	Mounting Method	Maximum Tie Width Accom.	Width (in.)	Length (in.)	Std. Pkg.	Bulk Pkg.
-	TC826-TB	#8 screw	.190	.500	1	-	1000
TC5828	TC828-TB	#8 screw	.190	.390	.875	100	1000

The TC826-TB mounting base can be used to tie bundles running parallel or perpendicular to length of base.

The TC828-TB mounting plate also handles ties installed in either direction and is somewhat smaller than TC826.

In-Line Base

Bulk Cat. No.	Mounting Method	Maximum Tie Width Accom.	Width (in.)	Length (in.)	Bulk Pkg.
TC815-TB	#10 screws	.301	.750	1.125	500

A standard two-hole base that installs in-line with the wire bundle which conceals it.

Single-Bundle Mounting Base

Std. Cat. No.	Bulk Cat. No.	Mounting Method	Maximum Tie Width Accom.	Width (in.)	Length (in.)	Std. Pkg.	Bulk Pkg.
-	TC101	#10 screws	.190	.500	2.00	-	1000
TC503	TC103	¼ screws	.301	.625	3.08	100	500

The TC101 and TC103 nylon bases provide a mounting range for bundles from 1/4" through 4" in diameter. One mounting hole is slotted to permit adjustment of the bundle position up to the time of actual bundle installation.

Thomas & Betts

Thomas & Betts

Cable Tie Mounting Bases

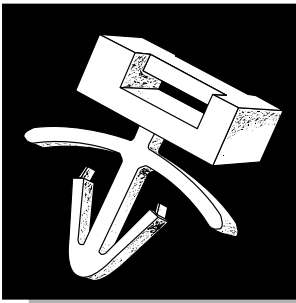

Push Mounts

PMNY-185

- Versatile push mount for cable ties to 50# tensile strength.
- For use in .187 / .192 mounting hole for panel thickness .030 to .080.
- Stocked in 6/6 Natural Nylon.
- UL Flammability: 94 V-2.
- Oxygen index: 31.

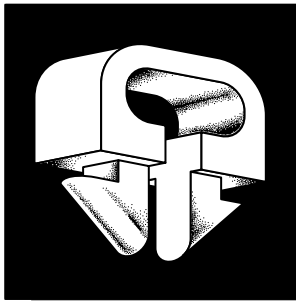
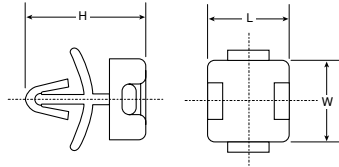

PMNY-245

- Accepts cable ties to 50# tensile (miniature through standard).
- For use in .250" mounting hole for maximum panel thickness of .062".
- Stocked in 6/6 Natural Nylon.
- UL Flammability 94 V-2.
- Oxygen index: 31.

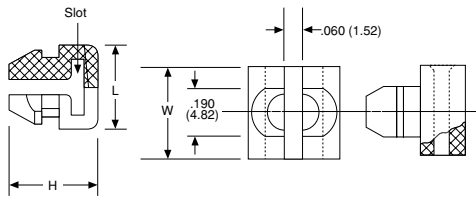

Cat. No.	Material	H Height		L Length		W Width		Slot Height		Slot Width		Bulk Pkg.
		Inch	(mm)	Inch	(mm)	Inch	(mm)	Inch	(mm)	Inch	(mm)	
PMNY-185-9-D	Natural Nylon	.640	(16.26)	.430	(10.92)	.430	(10.92)	.065	(1.65)	.065	(1.65)	500
PMNY-245-9-D		.355	(9.01)	.320	(8.12)	.320	(8.12)	.050	(1.27)	.220	(5.59)	500
Tolerance ±					.010		(.254)					

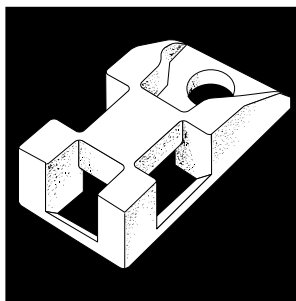

4-Way Mount

- 4-Way screw mounts for cable ties to 50# tensile strength.
- Mount with #6 or #8 screws.
- Available in 6/6 Natural Nylon.
- UL Flammability: 94 V-2.

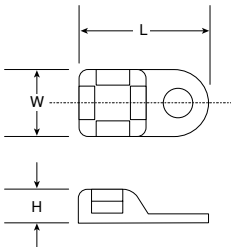

Cat. No.	Height	Length	Width	Slot Width	Mount Dia.	Bulk Pkg.
SMNY-220-9-D	.230	.950	.500	.220	.170	500
Tolerance ±			.015			



Thomas & Betts

Cable Clamps and Clips

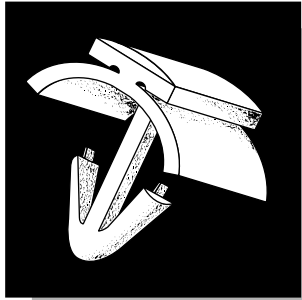

Snap Mounts

- For panel thicknesses from .060" to .150" to hold separate pieces of material together.
- Used with W4 or N4 Series Cable Clamps; allowable panel thickness is .030" to .050".

- Stocked in Natural 6/6 Nylon.
- UL Flammability 94 V-2.

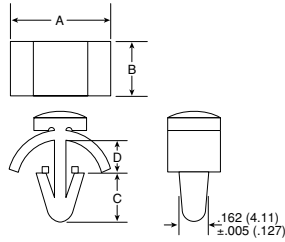

Cat. No.	Material	A		B		C		D		Bulk Pkg. Qty.
		Inch	(mm)	Inch	(mm)	Inch	(mm)	inch	(mm)	
MSNY-166-0-M	UV Black Nylon	.485	(12.32)	.312	(7.93)	.281	(7.14)	.180	(4.57)	1000
Tolerance ±					.010		(.254)			



Ty-Rap®/Ty-Fast®

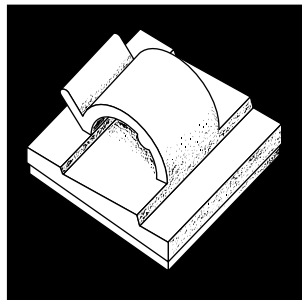

Round Adhesive Clips

- Diverse cable clamps for bundle diameters from .160 to .620.
- Mounted on a rubber based closed cell foam adhesive.

- Natural nylon.
- UL Flammability 94 V-2 (clip).
- Flexible center tang for removal or addition of cables.

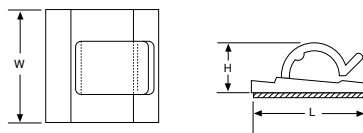

Cat. No.	Material	H Height		L Length		W Width		Maximum Bundle	Mounting Method	Bulk Pkg. Qty.
		Inch	(mm)	Inch	(mm)	Inch	(mm)			
RANY-160-9-D	Natural Nylon	.250	(6.35)	.630	(16.00)	.580	(14.73)	.160	Rubber Based Adhesive	500
RANY-280-9-D	Natural Nylon	.410	(10.41)	1.000	(25.40)	1.000	(25.40)	.280	Rubber Based Adhesive	500
RANY-530-9-D	Natural Nylon	.620	(15.75)	1.000	(25.40)	1.000	(25.40)	.530	Rubber Based Adhesive	500
RANY-620-9-D	Natural Nylon	.560	(14.22)	1.250	(31.75)	1.120	(28.45)	.620	Rubber Based Adhesive	500
Tolerance ±			.015		(.381)					

- Available July 1996.

Thomas & Betts

Thomas & Betts

Cable Clamps and Clips

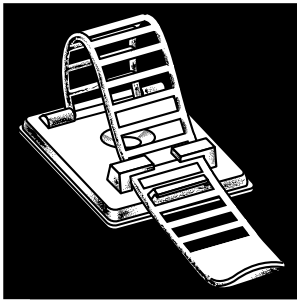

Adjustable Cable Clamps

- Three sizes for bundles from .118" to .984".
- Ladder style fastener is easily released and refastened.
- Supplied "single-cut" on a rubber based closed cell foam adhesive.
- Stocked in 6/6 Gray Nylon.
- UL Flammability 94 V-2 (clip).
- Optional screw hole for #4 or #5 flat head screw.

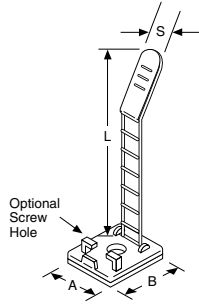

Cat. No.	Material	A		B		S		L		Applied Wire Range	Screw Hole Dia.		Std. Pkg.
		Inch	(mm)	Inch	(mm)	Inch	(mm)	Inch	(mm)		Inch	(mm)	
ULNY-013-8-C	Gray Nylon	.709	(18.00)	.984	(25.00)	.314	(8.00)	2.340	(59.50)	.118 - .500	.110	(2.79)	100
ULNY-018-8-C	Gray Nylon	.827	(21.00)	1.180	(30.00)	.472	(12.00)	3.120	(79.40)	.197 - .827	.110	(2.79)	100
ULNY-023-8-C	Gray Nylon	.984	(25.00)	1.380	(35.00)	.551	(14.00)	3.370	(85.50)	.275 - .984	.135	(3.43)	100
Tolerance ±			.015	(.381)		.010	(.254)	.030	(.762)				

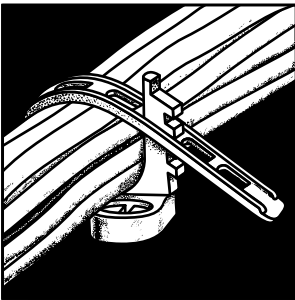

Tab-Lock Cable Clamps

- Adjustable cable clamp for diameters to ¾".
- Releasable and reusable. Add or remove wires from bundles as required.
- #6 or #8 82° flat head machine screw to mount.
- Stocked in 6/6 Natural Nylon.
- UL Flammability 94 V-2.

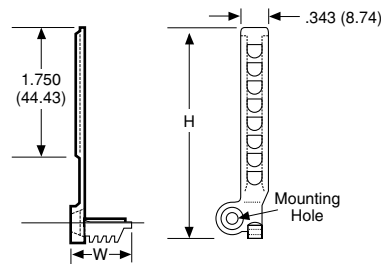

Cat. No.	Material	H Height		W Width		Adjustable Diameter		Mounting Method	Bulk Pkg. Qty.
		Inch	(mm)	Inch	(mm)	Inch	(mm)		
TBNY-750-9-M	Natural Nylon	2.833	(71.96)	.850	(21.59)	.375 - .750	(9.52 - 19.05)	#6, #8 Flat Head Screw	1000
Tolerance ±			.030	(.762)		.015	(.381)		

Ty-Rap®/Ty-Fast®

Thomas & Betts

Thomas & Betts

Cable Clamps and Clips

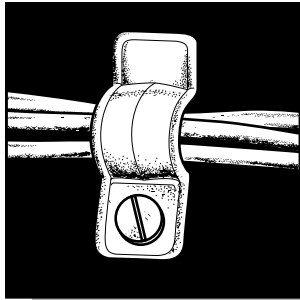

Flex Clips

- Utilizes nylon's "memory" to retain original shape even after repeated use.
- Ideal for temporary applications.
- Mounts with one #8 machine screw.
- Stocked in Natural 6/6 Nylon.
- UL Flammability 94 V-2.

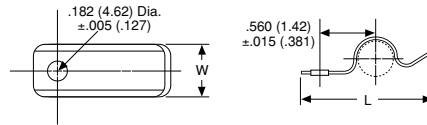

Cat. No.	Material	L Length		W Width		Max. Cable Diameter		Mounting Method	Bulk Pkg. Qty.
		Inch	(mm)	Inch	(mm)	Inch	(mm)		
FCNY-312-9-M	Natural Nylon	1.350	(34.29)	.500	(12.69)	.312	(7.93)	#8 Screw	1000
Tolerance ±		.020	(.508)	.015	(.381)				

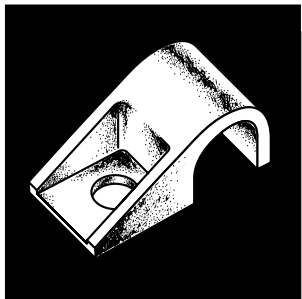

Half Clamps

- Rugged clamps with reinforced side panels for bundle diameters to .484".
- 203 mounting hole accepts #6 through #10 screws.
- Stocked in 6/6 Natural and heat stabilized Black Nylon.
- UL Flammability 94 V-2.

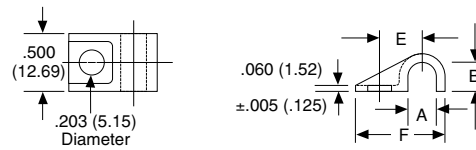

Cat. No.	Material	A		B		E		F		Bulk Pkg. Qty.
		Inch	(mm)	Inch	(mm)	Inch	(mm)	inch	(mm)	
CPNY-115-9-M	Natural Nylon	.115	(2.92)	.115	(2.92)	.314	(7.98)	.675	(17.15)	1000
CPNY-172-9-M	Natural Nylon	.172	(4.36)	.172	(4.36)	.336	(8.53)	.732	(18.59)	1000
CPNY-234-9-M	Natural Nylon	.234	(5.94)	.234	(5.94)	.370	(9.40)	.793	(20.14)	1000
CPNY-297-9-M	Natural Nylon	.297	(7.54)	.297	(7.54)	.400	(10.16)	.859	(21.82)	1000
CPNY-359-9-M	Natural Nylon	.359	(9.11)	.359	(9.11)	.435	(11.05)	.920	(23.37)	1000
CPNY-422-9-M	Natural Nylon	.422	(10.71)	.422	(10.71)	.470	(11.94)	.980	(24.89)	1000
CPNY-484-9-M	Natural Nylon	.484	(12.29)	.484	(12.29)	.500	(12.69)	1.044	(26.52)	1000
CPNY-115-0-M	Heat Stabilized Black Nylon	.115	(2.92)	.115	(2.92)	.314	(7.98)	.675	(17.15)	1000
CPNY-172-0-M	Heat Stabilized Black Nylon	.172	(4.36)	.172	(4.36)	.336	(8.53)	.732	(18.59)	1000
CPNY-234-0-M	Heat Stabilized Black Nylon	.234	(5.94)	.234	(5.94)	.370	(9.40)	.793	(20.14)	1000
CPNY-297-0-M	Heat Stabilized Black Nylon	.297	(7.54)	.297	(7.54)	.400	(10.16)	.859	(21.82)	1000
CPNY-359-0-M	Heat Stabilized Black Nylon	.359	(9.11)	.359	(9.11)	.435	(11.05)	.920	(23.37)	1000
CPNY-422-0-M	Heat Stabilized Black Nylon	.422	(10.71)	.422	(10.71)	.470	(11.94)	.980	(24.89)	1000
CPNY-484-0-M	Heat Stabilized Black Nylon	.484	(12.29)	.484	(12.29)	.500	(12.69)	1.044	(26.52)	1000
Tolerance ±			.010		(.254)		.015		(.381)	

Thomas & Betts

Thomas & Betts

Cable Clamps and Clips

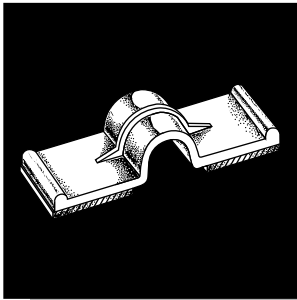

Press Clips

- 4 Sizes to accommodate bundles up to 1/2".
- Clips are provided on a rubber based closed cell foam adhesive.
- Stocked in 6/6 Natural Nylon. Contact factory for availability in special materials.
- UL Flammability 94 V-2 (clip).

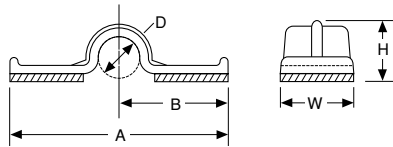

Cat. No.	Material	D Diameter		A		B		H		W		Bulk Pkg. Qty.
		Inch	(mm)	Inch	(mm)	Inch	(mm)	Inch	(mm)	Inch	(mm)	
PCNY-125-9-D	Natural Nylon	.125	(3.17)	.760	(19.30)	.380	(9.65)	.211	(5.36)	.375	(9.52)	500
PCNY-250-9-D	Natural Nylon	.250	(6.35)	1.380	(35.05)	.690	(17.52)	.324	(8.23)	.500	(12.69)	500
PCNY-375-9-D	Natural Nylon	.375	(9.52)	1.470	(37.32)	.735	(18.61)	.444	(11.29)	.625	(15.87)	500
PCNY-500-9-D	Natural Nylon	.500	(12.69)	1.590	(40.57)	.795	(20.19)	.585	(14.85)	.750	(19.05)	500
Tolerance ±	Natural Nylon	.010	(.254)	.020	(.508)			.010	(.254)			

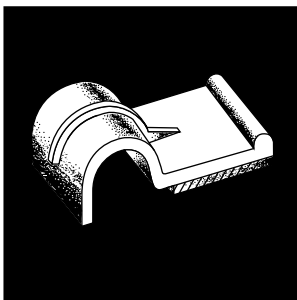

Half Press Clips

- 4 Sizes to accommodate bundles up to 1/2".
- Clips are provided on a rubber based closed cell foam adhesive.
- Stocked in 6/6 Natural Nylon. Contact factory for availability in special materials.
- UL Flammability 94 V-2 (clip).

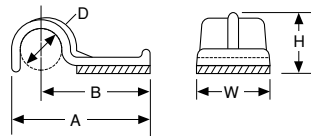

Cat. No.	Material	D Diameter		A		B		H		W		Bulk Pkg. Qty.
		Inch	(mm)	Inch	(mm)	Inch	(mm)	Inch	(mm)	Inch	(mm)	
HCNY-125-9-M	Natural Nylon	.125	(3.17)	.493	(12.52)	.380	(9.65)	.180	(4.57)	.375	(9.52)	1000
HCNY-250-9-M	Natural Nylon	.250	(6.35)	.865	(21.97)	.690	(17.52)	.325	(8.25)	.500	(12.69)	1000
HCNY-375-9-M	Natural Nylon	.375	(9.52)	.980	(24.88)	.750	(19.05)	.415	(10.54)	.625	(15.87)	1000
HCNY-500-9-M	Natural Nylon	.500	(12.69)	1.110	(28.19)	.820	(20.83)	.560	(14.22)	.750	(19.05)	1000
Tolerance ±	Natural Nylon	.010	(.254)	.020	(.508)			.010	(.254)			



Thomas & Betts

Cable Clamps and Clips

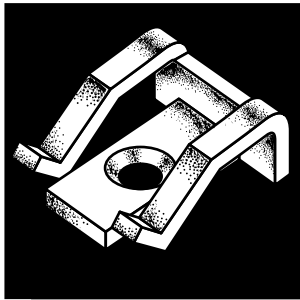

Flat Cable Clips

- Low profile clip for single or multiple layers of flat ribbon cable.
- FANY supplied on a rubber based closed cell foam adhesive.
- Screw mountable with a #4 flat head screw.
- Flexible tangs allow for easy removal and replacement of desired cable.
- Stocked in 6/6 Natural Nylon.
- UL Flammability 94 V-2 (clip).

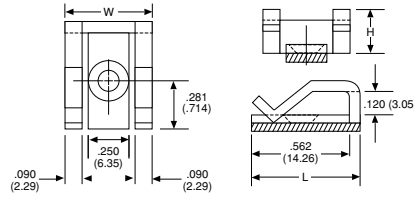

Cat. No.	Material	H Height		L Length		W Width		Mounting Method	Bulk Pkg. Qty.
		Inch	(mm)	Inch	(mm)	Inch	(mm)		
FANY-562-9-D	Natural Nylon	.264	(6.70)	.625	(15.87)	.500	(12.69)	Adhesive	500
FSNY-562-9-D	Natural Nylon	.233	(5.92)					#4 Screw	500
Tolerance ±		.010	(.254)	.015	(.381)				

Flat Cable Screw Clip

- Flat ribbon cable clamp with mounting hole for #8 screw.
- Stocked in Natural 6/6 Nylon.
- Flexible center tang allows for easy removal and replacement of desired cable.
- UL Flammability 94 V-2.

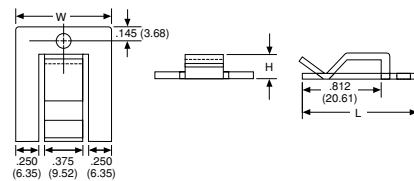

Cat. No.	Material	H Height		L Length		W Width		Mounting Method	Bulk Pkg. Qty.
		Inch	(mm)	Inch	(mm)	Inch	(mm)		
FSNY-812-9-D	Natural Nylon	.250	(3.17)	1.187	(30.15)	1.000	(25.40)	#8 Screw	500
Tolerance ±		.010	(.254)	.015	(.381)				



Ty-Rap®/Ty-Fast®

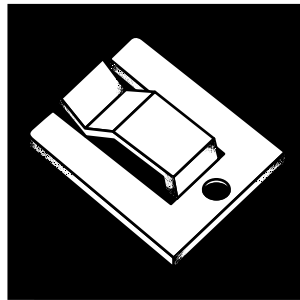

Thomas & Betts

Cable Clamps and Clips

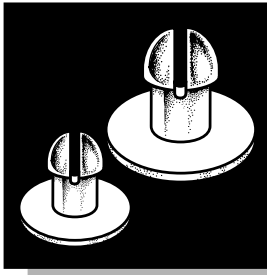

Stud Buttons

- Utilize nylon's "memory" to retain original shape after compression.
- Part numbers contain recommended mounting hole diameters.
- For use with Catamount strapping or panel thickness through .165" with mounting holes through #1/4.
- Stocked in heat stabilized Black Nylon for high heat applications.
- UL Flammability 94 V-2.

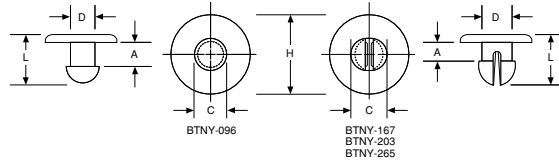

Cat. No.	H Head Dia.		A		C		D		L		Bulk Pkg. Qty.
	Inch	(mm)	Inch	(mm)	Inch	(mm)	Inch	(mm)	Inch	(mm)	
BTNY-167-0-D	.343	(8.71)	.125	(3.17)	.202	(5.13)	.165	(4.19)	.297	(7.54)	500
BTNY-203-0-D	.468	(11.88)	.156	(3.96)	.238	(6.04)	.200	(5.08)	.359	(9.11)	500
BTNY-265-0-D	.580	(14.73)	.171	(4.34)	.300	(7.62)	.260	(6.60)	.410	(10.41)	500
Tolerance ±					.010	(.254)					

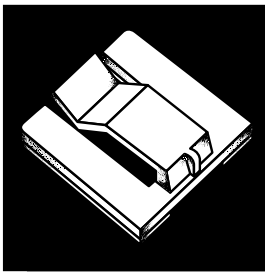

Flat Adhesive Clips

- Low profile clip for single or multiple layers of flat ribbon cable.
- Flexible center tang for removal or addition of cables.
- Supplied on a rubber based closed cell foam adhesive.
- Stocked in 6/6 Natural Nylon.
- UL Flammability 94 V-2 (clip).

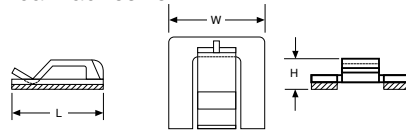

Cat. No.	Material	H Height		L Length		W Width		Mounting Method	Bulk Pkg. Qty.
		Inch	(mm)	Inch	(mm)	Inch	(mm)		
FANY-812-9-D	Natural Nylon	.281	(7.14)	1.000	(25.40)	1.000	(25.40)	Adhesive	500
Tolerance ±		.010	(.254)	.015	(.381)				

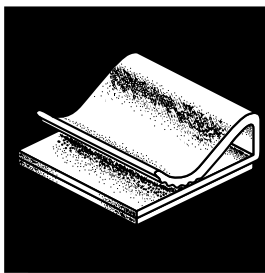

Flat PVC Clips

- Low profile clip for single or multiple layers of flat ribbon cable.
- "Single-Cut" on a rubber based closed cell foam adhesive.
- Gray PVC.
- UL Flammability 94 V-0 (clip).

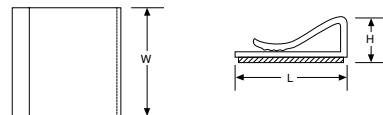

Cat. No.	Material	H Height		L Length		W Width		Mounting Method	Bulk Pkg. Qty.
		Inch	(mm)	Inch	(mm)	Inch	(mm)		
FRPV-1000-8-D	Gray PVC	.415	(5.84)	1.062	(26.97)	1.000	(25.40)	Adhesive	500
Tolerance ±		.015	(.381)	.030	(.762)	.015	(.381)		



Thomas & Betts

Cable Clamps and Clips



Gator Grip Hose Clamp

- 16 sizes for bundle diameters to 2 $\frac{3}{8}$ ".
- Removable and reusable. Twist by hand or with pliers to remove.
- Stocked in black Nylon. 100 pieces per package.
- UL Flammability 94 V-2.
- Request samples for testing to your application. Tested to 250 PSI.

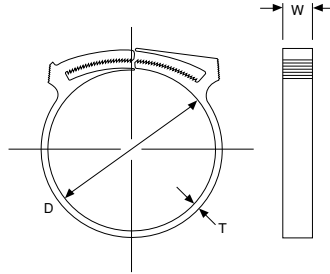

Cat. No.	D Nominal Diameter		D1 Closed Diameter		T Thickness		W Width		Bulk Pkg. Qty.
	Inch	(mm)	Inch	(mm)	Inch	(mm)	inch	(mm)	
GGNY-344-0-C	$\frac{13}{32}$	(10.32)	$\frac{1}{2}$	(8.73)	.070	(1.8)	.220	(5.6)	100
GGNY-406-0-C	$\frac{15}{32}$	(11.92)	$\frac{3}{4}$	(10.32)	.070	(1.8)	.220	(5.6)	100
GGNY-468-0-C	$\frac{17}{32}$	(13.49)	$\frac{5}{8}$	(11.91)	.070	(1.8)	.220	(5.6)	100
GGNY-531-0-C	$\frac{19}{32}$	(15.08)	$\frac{7}{8}$	(13.49)	.070	(1.8)	.220	(5.6)	100
GGNY-593-0-C	$2\frac{1}{32}$	(16.67)	$\frac{9}{8}$	(15.08)	.070	(1.8)	.220	(5.6)	100
GGNY-672-0-C	$\frac{13}{16}$	(20.64)	$\frac{4}{4}$	(17.07)	.070	(1.8)	.220	(5.6)	100
GGNY-750-0-C	$\frac{7}{8}$	(22.23)	$\frac{3}{4}$	(19.05)	.070	(1.8)	.220	(5.6)	100
GGNY-875-0-C	1	(25.40)	$\frac{7}{8}$	(22.23)	.070	(1.8)	.220	(5.6)	100
GGNY-953-0-C	$\frac{13}{32}$	(27.78)	$\frac{6}{16}$	(24.21)	.070	(1.8)	.310	(7.9)	100
GGNY-1031-0-C	$1\frac{13}{16}$	(30.16)	$1\frac{1}{2}$	(26.19)	.070	(1.8)	.310	(7.9)	100
GGNY-1250-0-C	$1\frac{7}{16}$	(36.51)	$1\frac{1}{4}$	(31.75)	.070	(1.8)	.360	(9.1)	100
GGNY-1406-0-C	$1\frac{5}{8}$	(41.28)	$1\frac{13}{32}$	(35.72)	.070	(1.8)	.360	(9.1)	100
GGNY-1593-0-C	$1\frac{13}{16}$	(46.04)	$1\frac{19}{32}$	(40.48)	.070	(1.8)	.360	(9.1)	100
GGNY-1687-0-C	$1\frac{29}{32}$	(48.42)	$1\frac{1}{16}$	(42.86)	.070	(1.8)	.360	(9.1)	100
GGNY-1875-0-C	$2\frac{1}{8}$	(53.98)	$1\frac{7}{8}$	(47.63)	.070	(1.8)	.400	(10.2)	100
GGNY-2125-0-C	$2\frac{1}{8}$	(60.33)	$2\frac{3}{8}$	(53.98)	.070	(1.8)	.400	(10.2)	100
Tolerance \pm			.010 (.254)						

Ty-Rap®/Ty-Fast®

Thomas & Betts

Thomas & Betts

Cable Clamps and Clips

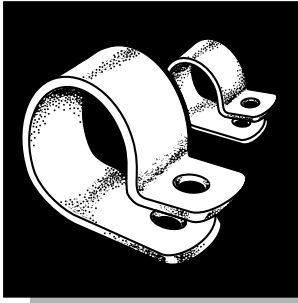

Plain Edge Cable Clamps

- Fully radiused inside edges with size markings in inches and millimeters for easy identification.
- Stocked in Natural White and Black 6/6 Nylon.
- 18 diameters and 2 widths with mounting holes for #4 through #10 screws.
- Plain edge cable clamps are designed to perform to NAS-1397P.

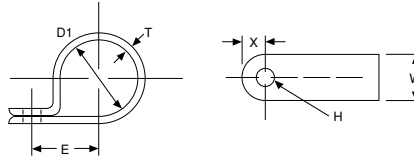

*Note: "C" Also 100 packs available. Replace "-M" with "-C" for 100 pack.

Cat. No.		D1 Closed Diameter		E		T		W		H Hole Diameter		X		Bulk Pkg. Qty.
White	Black	Inch	(mm)	Inch	(mm)	Inch	(mm)	Inch	(mm)	Inch	(mm)	Inch	(mm)	
N4NY-002-9-M	N4NY-002-0-M	.125	(3.2)	.343	(8.7)	.050	(1.3)	.375	(9.5)	.170	(4.3)	.218	(5.5)	1000
N4NY-003-9-M	N4NY-003-0-M	.187	(4.8)	.378	(9.6)	.050	(1.3)	.375	(9.5)	.170	(4.3)	.218	(5.5)	1000
N4NY-004-9-M	N4NY-004-0-M	.250	(6.4)	.421	(10.7)	.050	(1.3)	.375	(9.5)	.170	(4.3)	.218	(5.5)	1000
N4NY-005-9-M	N4NY-005-0-M	.312	(7.9)	.441	(11.2)	.050	(1.3)	.375	(9.5)	.170	(4.3)	.218	(5.5)	1000
N4NY-006-9-M	N4NY-006-0-M	.375	(9.5)	.464	(11.8)	.050	(1.3)	.375	(9.5)	.170	(4.3)	.218	(5.5)	1000
N4NY-007-9-M	N4NY-007-0-M	.437	(11.1)	.500	(12.7)	.050	(1.3)	.375	(9.5)	.170	(4.3)	.218	(5.5)	1000
N4NY-008-9-M	N4NY-008-0-M	.500	(12.7)	.530	(13.5)	.050	(1.3)	.375	(9.5)	.170	(4.3)	.218	(5.5)	1000
N4NY-002B-9-M	N4NY-002B-0-M	.125	(3.2)	.343	(8.7)	.050	(1.3)	.375	(9.5)	.203	(5.2)	.218	(5.5)	1000
N4NY-003B-9-M	N4NY-003B-0-M	.187	(4.8)	.378	(9.6)	.050	(1.3)	.375	(9.5)	.203	(5.2)	.218	(5.5)	1000
N4NY-004B-9-M	N4NY-004B-0-M	.250	(6.4)	.421	(10.7)	.050	(1.3)	.375	(9.5)	.203	(5.2)	.218	(5.5)	1000
N4NY-005B-9-M	N4NY-005B-0-M	.312	(7.9)	.441	(11.2)	.050	(1.3)	.375	(9.5)	.203	(5.2)	.218	(5.5)	1000
N4NY-006B-9-M	N4NY-006B-0-M	.375	(9.5)	.464	(11.8)	.050	(1.3)	.375	(9.5)	.203	(5.2)	.218	(5.5)	1000
N4NY-007B-9-M	N4NY-007B-0-M	.437	(11.1)	.500	(12.7)	.050	(1.3)	.375	(9.5)	.203	(5.2)	.218	(5.5)	1000
N4NY-008B-9-M	N4NY-008B-0-M	.500	(12.7)	.530	(13.5)	.050	(1.3)	.375	(9.5)	.203	(5.2)	.218	(5.5)	1000
N6NY-004C-9-M	N6NY-004C-0-M	.250	(6.4)	.437	(11.1)	.060	(1.5)	.500	(12.7)	.203	(5.2)	.218	(5.5)	1000
N6NY-005C-9-M	N6NY-005C-0-M	.312	(7.9)	.474	(12.0)	.060	(1.5)	.500	(12.7)	.203	(5.2)	.218	(5.5)	1000
N6NY-006C-9-M	N6NY-006C-0-M	.375	(9.5)	.500	(12.7)	.060	(1.5)	.500	(12.7)	.203	(5.2)	.218	(5.5)	1000
N6NY-007C-9-M	N6NY-007C-0-M	.437	(11.1)	.533	(13.5)	.060	(1.5)	.500	(12.7)	.203	(5.2)	.218	(5.5)	1000
N6NY-008C-9-M	N6NY-008C-0-M	.500	(12.7)	.553	(14.1)	.060	(1.5)	.500	(12.7)	.203	(5.2)	.218	(5.5)	1000
N6NY-009-9-M	N6NY-009-0-M	.562	(14.3)	.603	(15.3)	.060	(1.5)	.500	(12.7)	.203	(5.2)	.218	(5.5)	1000
N6NY-010-9-M	N6NY-010-0-M	.625	(15.9)	.625	(15.9)	.060	(1.5)	.500	(12.7)	.203	(5.2)	.218	(5.5)	1000
N6NY-011-9-M	N6NY-011-0-M	.687	(17.4)	.665	(16.9)	.060	(1.5)	.500	(12.7)	.203	(5.2)	.218	(5.5)	1000
N6NY-012-9-M	N6NY-012-0-M	.750	(19.1)	.699	(17.8)	.060	(1.5)	.500	(12.7)	.203	(5.2)	.218	(5.5)	1000
N6NY-013-9-M	N6NY-013-0-M	.812	(20.6)	.765	(19.9)	.060	(1.5)	.500	(12.7)	.203	(5.2)	.218	(5.5)	1000
N6NY-014-9-M	N6NY-014-0-M	.875	(22.2)	.795	(20.2)	.060	(1.5)	.500	(12.7)	.203	(5.2)	.218	(5.5)	1000
N6NY-016-9-M	N6NY-016-0-M	1.000	(25.4)	.825	(20.9)	.060	(1.5)	.500	(12.7)	.203	(5.2)	.218	(5.5)	1000
N6NY-018-9-D	N6NY-018-0-D	1.125	(28.6)	.940	(23.8)	.060	(1.5)	.500	(12.7)	.203	(5.2)	.218	(5.5)	500
N6NY-019-9-D	N6NY-019-0-D	1.187	(30.1)	.963	(24.5)	.060	(1.5)	.500	(12.7)	.203	(5.2)	.218	(5.5)	500
N6NY-020-9-D	N6NY-020-0-D	1.250	(31.8)	.980	(24.9)	.060	(1.5)	.500	(12.7)	.203	(5.2)	.218	(5.5)	500
N6NY-022-9-D	N6NY-022-0-D	1.375	(34.9)	1.045	(26.5)	.060	(1.5)	.500	(12.7)	.203	(5.2)	.218	(5.5)	500
N6NY-024-9-D	N6NY-024-0-D	1.500	(38.1)	1.114	(28.3)	.060	(1.5)	.500	(12.7)	.203	(5.2)	.218	(5.5)	500
Tolerance ±		.010 (.254)	.030 (.762)	.005 (.127)	.015 (.381)	.010 (.254)	.030 (.762)							



Thomas & Betts

Thomas & Betts

Cable Clamps and Clips

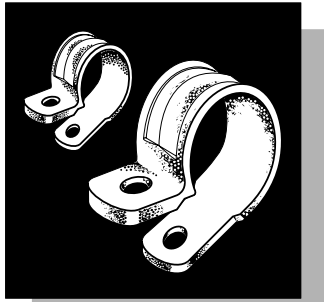

Self-Aligning Cable Clamps

- Molded-in saddle washer enhances performance and appearance.
- Self-Alignment feature makes this clamp ideal for assembly applications.
- 14 diameters and 2 widths with mounting holes for #4 through #10 screws.
- UL Flammability W.NY 94 V-2; W.TZ 94 V-0.
- Stocked in Natural and heat stabilized black 6/6 Nylon, and DuPont Tefzel for highest heat applications.
- Item numbers molded-in for easy identification.

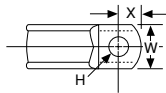
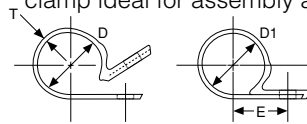

Cat. No.	Material	D Nominal Diameter		D1 Closed Diameter		E		T Thickness		W Width		H Hole Diameter		X	Bulk Pkg. Qty.	
		Inch	(mm)	Inch	(mm)	Inch	(mm)	Inch	(mm)	Inch	(mm)	Inch	(mm)			
W4NY-125-9-M	Natural Nylon	.125	(3.17)	.114	(2.89)	.333	(8.46)	.040	(1.02)	.375	(9.52)	.167	(4.24)	.257	(6.53)	1000
W4NY-187-9-M	Natural Nylon	.187	(4.76)	.172	(4.36)	.355	(9.02)	.040	(1.02)	.375	(9.52)	.167	(4.24)	.218	(5.53)	1000
W4NY-250-9-M	Natural Nylon	.250	(6.34)	.234	(5.94)	.382	(9.70)	.040	(1.02)	.375	(9.52)	.167	(4.24)	.190	(4.83)	1000
W4NY-312-9-M	Natural Nylon	.312	(7.93)	.297	(7.54)	.422	(10.71)	.040	(1.02)	.375	(9.52)	.167	(4.24)	.205	(5.21)	1000
W4NY-375-9-M	Natural Nylon	.375	(9.52)	.359	(9.11)	.454	(11.53)	.040	(1.02)	.375	(9.52)	.167	(4.24)	.210	(5.33)	1000
W4NY-500-9-M	Natural Nylon	.500	(12.69)	.484	(12.29)	.490	(12.45)	.040	(1.02)	.375	(9.52)	.167	(4.24)	.266	(6.76)	1000
W6NY-187-9-M	Natural Nylon	.187	(4.76)	.172	(4.36)	.375	(9.52)	.060	(1.52)	.500	(12.69)	.203	(5.15)	.241	(6.12)	1000
W6NY-250-9-M	Natural Nylon	.250	(6.34)	.234	(5.94)	.407	(10.34)	.060	(1.52)	.500	(12.69)	.203	(5.15)	.241	(6.12)	1000
W6NY-312-9-M	Natural Nylon	.312	(7.93)	.297	(7.54)	.445	(11.30)	.060	(1.52)	.500	(12.69)	.203	(5.15)	.280	(7.11)	1000
W6NY-375-9-M	Natural Nylon	.375	(9.52)	.359	(9.11)	.484	(12.29)	.060	(1.52)	.500	(12.69)	.203	(5.15)	.291	(7.39)	1000
W6NY-437-9-M	Natural Nylon	.437	(11.11)	.422	(10.71)	.522	(13.25)	.060	(1.52)	.500	(12.69)	.203	(5.15)	.263	(6.68)	1000
W6NY-500-9-M	Natural Nylon	.500	(12.69)	.484	(12.29)	.560	(14.22)	.060	(1.52)	.500	(12.69)	.203	(5.15)	.272	(6.91)	1000
W6NY-562-9-M	Natural Nylon	.562	(14.28)	.547	(13.90)	.657	(16.68)	.060	(1.52)	.500	(12.69)	.203	(5.15)	.236	(5.99)	1000
W6NY-625-9-M	Natural Nylon	.625	(15.87)	.609	(15.46)	.637	(16.17)	.060	(1.52)	.500	(12.69)	.203	(5.15)	.290	(7.37)	1000
W6NY-687-9-M	Natural Nylon	.687	(17.46)	.672	(17.06)	.694	(17.63)	.060	(1.52)	.500	(12.69)	.203	(5.15)	.327	(8.31)	1000
W6NY-750-9-M	Natural Nylon	.750	(19.04)	.734	(18.64)	.726	(18.44)	.060	(1.52)	.500	(12.69)	.203	(5.15)	.326	(8.28)	1000
W6NY-812-9-M	Natural Nylon	.812	(20.63)	.797	(20.24)	.776	(19.71)	.060	(1.52)	.500	(12.69)	.203	(5.15)	.323	(8.20)	1000
W6NY-875-9-D	Natural Nylon	.875	(22.22)	.859	(21.81)	.733	(18.62)	.060	(1.52)	.500	(12.69)	.203	(5.15)	.310	(7.87)	500
W6NY-1000-9-D	Natural Nylon	1.000	(25.39)	.984	(24.99)	.881	(22.38)	.060	(1.52)	.500	(12.69)	.203	(5.15)	.292	(7.42)	500
W6NY-1250-9-D	Natural Nylon	1.250	(31.73)	1.227	(31.16)	1.010	(25.65)	.060	(1.52)	.500	(12.69)	.203	(5.15)	.339	(8.61)	500
W4NY-125-0-M	Heat Stabilized Black Nylon	.125	(3.17)	.114	(2.89)	.333	(8.46)	.040	(1.02)	.375	(9.52)	.167	(4.24)	.257	(6.53)	1000
W4NY-187-0-M	Heat Stabilized Black Nylon	.187	(4.76)	.172	(4.36)	.355	(9.02)	.040	(1.02)	.375	(9.52)	.167	(4.24)	.218	(5.53)	1000
W4NY-250-0-M	Heat Stabilized Black Nylon	.250	(6.34)	.234	(5.94)	.382	(9.70)	.040	(1.02)	.375	(9.52)	.167	(4.24)	.190	(4.83)	1000
W4NY-312-0-M	Heat Stabilized Black Nylon	.312	(7.93)	.297	(7.54)	.422	(10.71)	.040	(1.02)	.375	(9.52)	.167	(4.24)	.205	(5.21)	1000
W4NY-375-0-M	Heat Stabilized Black Nylon	.375	(9.52)	.359	(9.11)	.454	(11.53)	.040	(1.02)	.375	(9.52)	.167	(4.24)	.210	(5.33)	1000
W4NY-500-0-M	Heat Stabilized Black Nylon	.500	(12.69)	.484	(12.29)	.490	(12.45)	.040	(1.02)	.375	(9.52)	.167	(4.24)	.266	(6.76)	1000
W6NY-187-0-M	Heat Stabilized Black Nylon	.187	(4.76)	.172	(4.36)	.375	(9.52)	.060	(1.52)	.500	(12.69)	.203	(5.15)	.241	(6.12)	1000
W6NY-250-0-M	Heat Stabilized Black Nylon	.250	(6.34)	.234	(5.94)	.407	(10.34)	.060	(1.52)	.500	(12.69)	.203	(5.15)	.241	(6.12)	1000
W6NY-312-0-M	Heat Stabilized Black Nylon	.312	(7.93)	.297	(7.54)	.445	(11.30)	.060	(1.52)	.500	(12.69)	.203	(5.15)	.280	(7.11)	1000
W6NY-375-0-M	Heat Stabilized Black Nylon	.375	(9.52)	.359	(9.11)	.484	(12.29)	.060	(1.52)	.500	(12.69)	.203	(5.15)	.291	(7.39)	1000
W6NY-437-0-M	Heat Stabilized Black Nylon	.437	(11.11)	.422	(10.71)	.522	(13.25)	.060	(1.52)	.500	(12.69)	.203	(5.15)	.263	(6.68)	1000
W6NY-500-0-M	Heat Stabilized Black Nylon	.500	(12.69)	.484	(12.29)	.560	(14.22)	.060	(1.52)	.500	(12.69)	.203	(5.15)	.272	(6.91)	1000
W6NY-562-0-M	Heat Stabilized Black Nylon	.562	(14.28)	.547	(13.90)	.657	(16.68)	.060	(1.52)	.500	(12.69)	.203	(5.15)	.236	(5.99)	1000
W6NY-625-0-M	Heat Stabilized Black Nylon	.625	(15.87)	.609	(15.46)	.637	(16.17)	.060	(1.52)	.500	(12.69)	.203	(5.15)	.290	(7.37)	1000
W6NY-687-0-M	Heat Stabilized Black Nylon	.687	(17.46)	.672	(17.06)	.694	(17.63)	.060	(1.52)	.500	(12.69)	.203	(5.15)	.327	(8.31)	1000
W6NY-750-0-M	Heat Stabilized Black Nylon	.750	(19.04)	.734	(18.64)	.726	(18.44)	.060	(1.52)	.500	(12.69)	.203	(5.15)	.326	(8.28)	1000
W6NY-812-0-M	Heat Stabilized Black Nylon	.812	(20.63)	.797	(20.24)	.776	(19.71)	.060	(1.52)	.500	(12.69)	.203	(5.15)	.323	(8.20)	1000
W6NY-875-0-D	Heat Stabilized Black Nylon	.875	(22.22)	.859	(21.81)	.733	(18.62)	.060	(1.52)	.500	(12.69)	.203	(5.15)	.310	(7.87)	500
W6NY-1000-0-D	Heat Stabilized Black Nylon	1.000	(25.39)	.984	(24.99)	.881	(22.38)	.060	(1.52)	.500	(12.69)	.203	(5.15)	.292	(7.42)	500
W6NY-1250-0-D	Heat Stabilized Black Nylon	1.250	(31.73)	1.227	(31.16)	1.010	(25.65)	.060	(1.52)	.500	(12.69)	.203	(5.15)	.339	(8.61)	500
Tolerance ±				.010	(.254)	.030	(.762)	.005	(.127)	.015	(.381)	.010	(.254)	.030	(.762)	

(Continued)

Ty-Rap®/Ty-Fast®



Thomas & Betts

Cable Clamps and Clips

Self-Aligning Cable Clamps (continued) – For Extreme Applications

Cat. No.	Material	D Nominal Diameter		D1 Closed Diameter		E		T Thickness		W Width		H Hole Diameter		X		Bulk Pkg. Qty.
		Inch	(mm)	Inch	(mm)	Inch	(mm)	Inch	(mm)	Inch	(mm)	Inch	(mm)	Inch	(mm)	
W4TZ-125-5-D	Tefzel	.125	(3.17)	.114	(2.89)	.333	(8.46)							.257	(6.53)	500
W4TZ-187-5-D	Tefzel	.187	(4.76)	.172	(4.36)	.355	(9.02)							.218	(5.53)	500
W4TZ-250-5-D	Tefzel	.250	(6.34)	.234	(5.94)	.382	(9.70)	.040	(1.02)	.375	(9.52)	.167	(4.24)	.190	(4.83)	500
W4TZ-312-5-D	Tefzel	.312	(7.93)	.297	(7.54)	.422	(10.71)							.205	(5.21)	500
W4TZ-375-5-D	Tefzel	.375	(9.52)	.359	(9.11)	.454	(11.53)							.210	(5.33)	500
W4TZ-500-5-D	Tefzel	.500	(12.69)	.484	(12.29)	.490	(12.45)							.266	(6.76)	500
W6TZ-187-5-D	Tefzel	.187	(4.76)	.172	(4.36)	.375	(9.52)							.241	(6.12)	500
W6TZ-250-5-D	Tefzel	.250	(6.34)	.234	(5.94)	.407	(10.34)									500
W6TZ-312-5-D	Tefzel	.312	(7.93)	.297	(7.54)	.445	(11.30)							.280	(7.11)	500
W6TZ-375-5-D	Tefzel	.375	(9.52)	.359	(9.11)	.484	(12.29)	.060	(1.52)	.500	(12.69)	.203	(5.15)	.291	(7.39)	500
W6TZ-437-5-D	Tefzel	.437	(11.11)	.422	(10.71)	.522	(13.25)							.263	(6.68)	500
W6TZ-500-5-D	Tefzel	.500	(12.69)	.484	(12.29)	.560	(14.22)							.272	(6.91)	500
W6TZ-625-5-D	Tefzel	.625	(15.87)	.609	(15.46)	.637	(16.17)							.290	(7.37)	500
W6TZ-750-5-D	Tefzel	.750	(19.04)	.734	(18.64)	.726	(18.44)							.326	(8.28)	500
Tolerance ±	Tefzel			.010	(.254)	.030	(.762)	.005	(.127)	.015	(.381)	.010	(.254)	.030	(.762)	

- Tefzel is a Trademark of the DuPont Corporation
Patent No. 4535960.

Ty-Rap®/Ty-Fast®

Thomas & Betts

Thomas & Betts

Harnessing Accessories

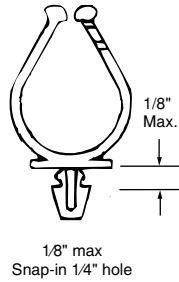

Mechanical-Locking Routing Clamps

Bulk Cat. No.	Mounting Hole Size	Maximum Wire Bundle Diameter (in.)	Width (in.)	Length (in.)	Bulk Pkg.
TC88	.250	.500	.250	.891	100
TC95	.250	1.000	.500	1.590	100

The locking clamp is available in several mounting styles, as shown. This clamp acts as a retainer during wire routing and as a positive clamp when desired. Anti-rotational peg is available.

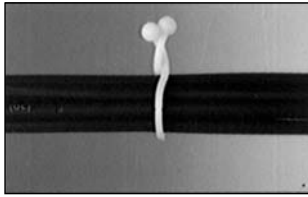

TL075

Twist-lock cable ties provide a quick and convenient method for binding wires together in light-duty applications. The reusable twist-lock ties come in two mounting base versions. One for push-in mounting (3/16" diameter hole) and one with an adhesive base.

Twist-Lock Cable Ties

Cat. No.	Bundle Range (in.)	Std. Pkg.
TL075	1/16" to 3/4"	100
TC060	1/2" to 5/8"	100
TC050A	1/8" to 3/2"	100

Note: For TC060 use .188 (3/16") mounting hole.

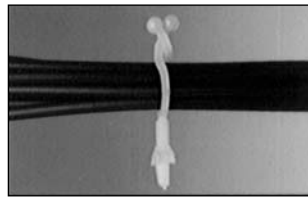

TC060

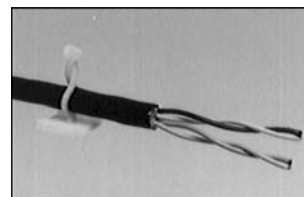

TC050A

Harness Clips

Bulk Cat. No.	Mounting Hole Size	Maximum Wire Bundle Diameter (in.)	Bulk Pkg.
HCP438	1/4"	.375	1000

Here is an inexpensive harness clip for grouping wires in appliances, office equipment and other noncritical applications. Designed to perform the same basic function as a cable tie in holding wires together, the new adjustable, self-locking clip requires no tools for installation. A projecting prong is simply pressed into a 1/4" hole where it compresses and locks. The simple ratchet-type lock is released by moving the locking lever.

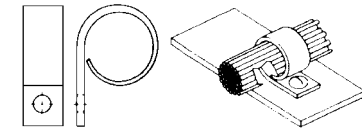

AC-loop retaining clamp is ideal to support long runs in point-to-point wiring or as a harness aid. Rigid PVC.

HBundle-Retaining Clamp

Bulk Cat. No.	Mounting Method	Maximum Wire Bundle Diameter (in.)	Width (in.)	Bulk Pkg.
TC70	#10 screw	.250	.400	100
TC71	#10 screw	.500	.400	100
TC72	#10 screw	.750	.500	100
TC73	#10 screw	1.000	.500	100
TC74	#10 screw	1.500	.500	100

Thomas & Betts

Thomas & Betts

Harnessing Accessories

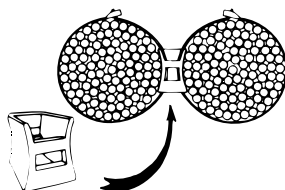
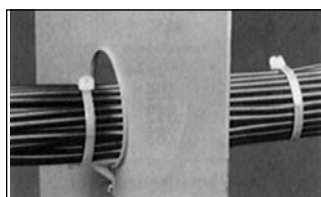
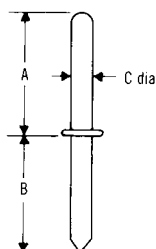
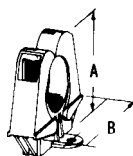
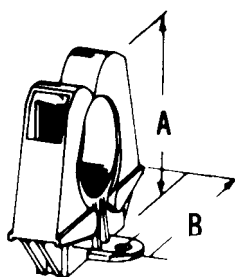

Wire-Bundle Retainers

Bulk Cat. No.	Fastener	Maximum Wire Bundle Diameter (in.)	Width (in.)	Height (in.)	Bulk Pkg.
TC86	#6 screws	.750	1.750	1.813	25
TC87	#6 screws	1.250	2.469	2.281	10

These retainers consist of a spring-loaded clip and an elastic bundle support. Wires are inserted simply by snapping them through spring-loaded clips. Wires are held 1/2 inch above work surface for easy tying.

Harness-Board Nails

Bulk Cat. No.	A (in.)	Dimensions B (in.)	C (in.)	Bulk Pkg.
HBP34	.750	.625	.072	100
HBP-1	1.000	.625	.072	100
HBP112	1.500	.625	.082	100
HBP2	2.000	.625	.092	100
HBP212	2.500	.625	.105	100
HBP3	3.000	.625	.120	100

Hardened, nickel plated steel.

Bulkhead Bundle Support Feed-Through

Bulk Cat. No.	Mounting Method	Maximum Tie Width Accom.	Width (in.)	Length (in.)	Bulk Pkg.
TC131	#6 screw	.190	1.115	1.890	1000

TC131 bulkhead mounting base can be installed from either side. Ties are installed through the clamp on either side of the bulkhead.

Wire-Bundle Spacer

Cat. No.	Maximum Tie Width Accom.	Width (in.)	Length (in.)	Std. Pkg.	Bulk Pkg.
TC5339	.190	.266	.500	100	500

Ty-Rap®/Ty-Fast®



Thomas & Betts

Mounting Bases for Heavy-Duty Applications



Ty-Rap® Mounting Base for Lashing Tie

Cat. No.	Mounting Method	Maximum Tie Width Accom.	Width (in.)	Length (in.)	Std. Pkg.
TC5355	#8 screw	.500	.750	1.125	25
TC5356	#10 screw	.500	.750	1.125	25
TC5357	¼ screw	.500	.750	1.125	25

Weather-resistant nylon mounting base for use with lashing tie Cat. No. TY-5409 (.500" wide).

Ty-Rap® Mounting Base for Masonry and Brick Surfaces

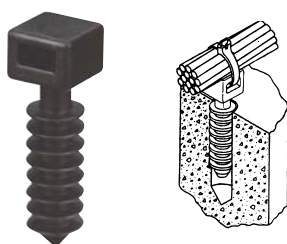

Cat. No.	Hole Size in Masonry	Maximum Tie Width Accom.	Std. Pkg.
TC5358	¼	.190	100
TC5359	¾	.500	50

- Quick, easy installation without adhesives or epoxies.
- Provides a quick, easy means of attaching cable and wires to masonry surfaces.
- Installs simply by tapping it into a drilled hole.
- It's immediately ready to accept a cable tie and wire bundle, no tedious surface preparation, no waiting for adhesives to set.
- Provides quick, dependable mechanical installation.
- Replaces a variety of anchors, clamps, screws, and adhesives.
- Designed for both indoor and outdoor applications made of a special impact and ultraviolet resistant black nylon, the new base is designed for both indoor and outdoor use, in addition, shelf life is indefinite because it uses no adhesives.

Framing Channel Clamp

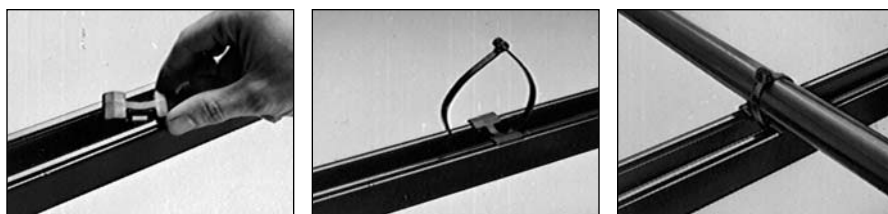

Mounting bases for heavy duty applications are made from high-impact weather-resistant nylon.

When fastening wire bundles, cables, or hoses to framing channels, you can cut costs considerably by using the Ty-Rap® cable clamp. It is made of smooth, weather-resistant nylon and designed to protect cable insulation and hoses from wear or damage as can occur with metal clamps. The clamp may be used for both indoor or outdoor applications. It installs in the framing channel with a simple push and twist. It requires no screws, nuts or tools. The clamp fits all 1½" and 1¾" channels regardless of channel depth.

Cat. No.	Channel Size	Maximum Tie Width Accom.	Std. Pkg.
TC5363X	1.5 & 1.625	.301	50

Thomas & Betts

Ty-Rap®/Ty-Fast®

Only two sizes to stock—reduces inventory
The new base features a specially designed head which is range-taking. Just two sizes can accommodate virtually all of your cable-to-masonry clamping needs.



- **Installs with a push and twist**
- **Designed for indoor or outdoor use**
- **Smooth design protects cable insulation**
- **Takes range of cable diameters**

Thomas & Betts

Mounting Bases for Heavy-Duty Applications



The Stud Mount Cable Fastening System includes a range of bases and the custom drill bit which mounts all sizes.

Features and Benefits

- **Fast, easy installation, using standard 3/8" power drill**
- **Custom drill bit quickly installs base to proper torque—won't crack or break mounting base due to being overtightened**
- **Unlimited harnessing flexibility using conventional T&B cable ties**
- **Unique 4-way multi-directional design**
- **10 position harness capability**
- **Available for 3/8", 1/2", 5/8", & 3/4" stud/bolt sizes**
- **Self-tapping thread design for reliable installation onto stud**
- **High pull-out strength of 500 + lbs**
- **Custom application tool for standard 3/8" power drill**
- **Material: Black 6/6 Nylon**

Fast, easy wire management to last for the long haul.

Thomas & Betts' Stud Mount Fastening System is a fast and simple harnessing method for neat, versatile wire management. Using a custom drill bit for your 3/8" power drill, the Stud Mount base is quickly attached onto a stud to the proper torque every time. The innovative "X" design of the base reliably supports many types of cable or hose assemblies using a wide range of conventional T&B cable ties. Designed with ten separate lashing positions, the Stud Mount offers unlimited wire harnessing arrangements. T&B's Stud Mount is available in four convenient stud bolt sizes.



During installation, the custom Stud Mount drill bit ejects itself from mounting base, ensuring proper torque and preventing cracking or breaking of the mount from being overtightened.



Virtually unlimited harnessing flexibility is provided in the unique 10-position harness design of the Stud Mount base.

Ordering Information

Cat. No.	Description	Stud Size	Material	Color
XMNY-375-0-D	Mount Fastener	3/8"	Nylon 6/6, UV Stabilized	Black
XMNY-500-0-D	Mount Fastener	1/2"	Nylon 6/6, UV Stabilized	Black
XMNY-625-0-D	Mount Fastener	5/8"	Nylon 6/6, UV Stabilized	Black
XMNY-750-0-D	Mount Fastener	3/4"	Nylon 6/6, UV Stabilized	Black
WTXM	Application Tool	—	Tool Steel	—

Ty-Rap®/Ty-Fast®

Thomas & Betts

Thomas & Betts

Wire Protection Products

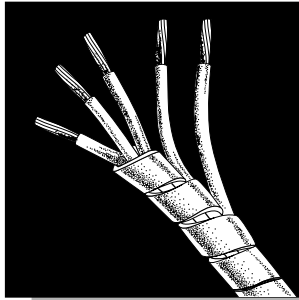

Spiral Wrap

- For protection of bundles from .063" to 7".
- Install gapped for greater flexibility or butted for maximum abrasion resistance, insulation and rigidity.
- Stocked in 3 materials including Polyethylene and 6/6 Nylon.
- a.k.a.: Reverse cut, left-hand cut, counter clockwise cut.
- Use cutting tool SR-100.

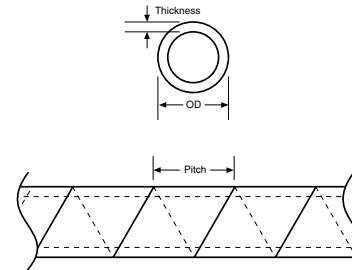

Cat. No.	Material	Outside Diameter		Pitch		Nominal Wall Thickness		Min./Max. Bundle Range				UL Flammability	
		Inch	(mm)	Inch	(mm)	Inch	(mm)	Inch	(mm)	Inch	(mm)		
SRPE-125-9-C													
SRPE-187-9-C	Natural Polyethylene	.187	(4.8)	.240	(6.1)	.040	(1.0)	.125	(3.2)	to	1.500	(25.9)	94 HB
SRPE-250-9-C	Natural Polyethylene	.250	(6.4)	.375	(9.5)	.045	(1.1)	.188	(4.8)	to	2.000	(50.8)	94 HB
SRPE-375-9-C	Natural Polyethylene	.375	(9.5)	.438	(11.1)	.052	(1.3)	.313	(7.9)	to	3.000	(76.2)	94 HB
SRPE-500-9-C	Natural Polyethylene	.500	(12.7)	.563	(14.3)	.062	(1.6)	.375	(9.5)	to	4.000	(102.0)	94 HB
SRPE-625-9-C	Natural Polyethylene	.625	(15.9)	.625	(15.9)			.625	(15.9)	to	4.500	(114.3)	94 HB
SRPE-750-9-C	Natural Polyethylene	.750	(19.1)	.750	(19.1)	.065	(1.7)	.750	(19.1)	to	5.000	(127.0)	94 HB
SRPE-1000-9-C	Natural Polyethylene	1.000	(25.4)	1.110	(28.2)	.070	(1.8)	1.000	(25.4)	to	7.000	(177.8)	94 HB
SRPE-125-0-C													
SRPE-187-0-C	UV Black Polyethylene	.187	(4.8)	.240	(6.1)	.040	(1.0)	.125	(3.2)	to	1.500	(25.9)	94 HB
SRPE-250-0-C	UV Black Polyethylene	.250	(6.4)	.375	(9.5)	.045	(1.1)	.188	(4.8)	to	2.000	(50.8)	94 HB
SRPE-375-0-C	UV Black Polyethylene	.375	(9.5)	.438	(11.1)	.052	(1.3)	.313	(7.9)	to	3.000	(76.2)	94 HB
SRPE-500-0-C	UV Black Polyethylene	.500	(12.7)	.563	(14.3)	.062	(1.6)	.375	(9.5)	to	4.000	(102.0)	94 HB
SRPE-625-0-C	UV Black Polyethylene	.625	(15.9)	.625	(15.9)			.625	(15.9)	to	4.500	(114.3)	94 HB
SRPE-750-0-C	UV Black Polyethylene	.750	(19.1)	.750	(19.1)	.065	(1.7)	.750	(19.1)	to	5.000	(127.0)	94 HB
SRPE-1000-0-C	UV Black Polyethylene	1.000	(25.4)	1.110	(28.2)	.070	(1.8)	1.000	(25.4)	to	7.000	(177.8)	94 HB
SRNY-250-9-C	Natural Nylon 6/6	.250	(6.4)	.375	(9.5)	.025	(.6)	.187	(4.8)	to	2.000	(50.8)	94 HB
SRNY-375-9-C	Natural Nylon 6/6	.375	(9.5)	.438	(11.1)			.312	(7.9)	to	3.000	(76.2)	94 HB
SRNY-500-9-C	Natural Nylon 6/6	.500	(12.7)	.563	(14.3)	.035	(.9)	.375	(9.5)	to	4.000	(102.0)	94 HB
SRTL-250-WH-C	Teflon®	.250	(6.4)	.375	(9.5)	.030	(.76)	.188	(4.8)	to	2.000	(50.8)	94 V-0
SRTL-375-WH-C	Teflon®	.375	(9.5)	.438	(11.1)	.030	(.76)	.313	(7.9)	to	3.000	(76.2)	94 V-0
SRTL-500-WH-C	Teflon®	.500	(12.7)	.563	(14.3)	.030	(.76)	.375	(9.5)	to	4.000	(102.0)	94 V-0
SRTL-625-WH-C	Teflon®	.625	(15.9)	.625	(15.9)	.030	(.76)	.625	(15.9)	to	4.500	(114.3)	94 V-0
SRTL-750-WH-C	Teflon®	.750	(19.1)	.750	(19.1)	.030	(.76)	.750	(19.1)	to	5.000	(127.0)	94 V-0
Tolerance ±		.030	(.762)		.010	(.254)							

• Stocked in 100 foot rolls.

SR-100 Cutting Tool

Use our SR-100 cutting tool for all your plastic pipe and PVC conduit needs to 1¼" I.D.

Features:

- High-carbon, Teflon®-coated replaceable steel blade.

- Contoured handle resists tube crushing.
- Produces no "sawdust", no need to debur.
- Lightweight, low-profile and no exposed blade when stored.

Teflon® is a trademark of the DuPont Corporation.

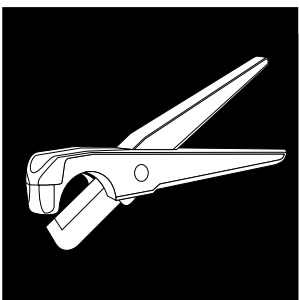

Cat. No.	Description
SR-100	Cutting Tool
SR-R	Replacement Blade

Thomas & Betts

Thomas & Betts

Wire Protection Products

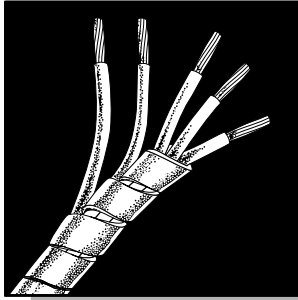

Forward Cut Spiral Wrap

- For protection of bundles from .063" to 7".
- Install gapped for greater flexibility or butted for maximum abrasion resistance, insulation and rigidity.
- Available in 4 materials including Polyethylene, Nylon and Teflon®.
- a.k.a.: Right-hand cut, clockwise cut.
- Use cutting tool SR-100.

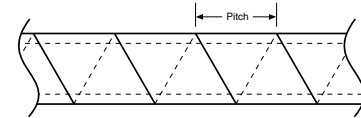
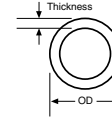

Cat. No.	Material	Outside Diameter		Pitch		Nominal Wall Thickness		Min./Max. Bundle Range				UL Flammability	
		Inch	(mm)	Inch	(mm)	Inch	(mm)	Inch	(mm)	Inch	(mm)		
SRPE-250-9-C	Natural Polyethylene	.250	(6.4)	.375	(9.5)	.045	(1.1)	.188	(4.8)	to	2.000	(50.8)	94 HB
SRPE-187F-9-C	Natural Polyethylene	.187	(4.8)	.240	(6.1)	.040	(1.0)	.125	(3.2)	to	1.500	(25.9)	94 HB
SRPE-250F-9-C	Natural Polyethylene	.250	(6.4)	.375	(9.5)	.045	(1.1)	.188	(4.8)	to	2.000	(50.8)	94 HB
SRPE-375F-9-C	Natural Polyethylene	.375	(9.5)	.438	(11.1)	.052	(1.3)	.313	(7.9)	to	3.000	(76.2)	94 HB
SRPE-500F-9-C	Natural Polyethylene	.500	(12.7)	.563	(14.3)	.062	(1.6)	.375	(9.5)	to	4.000	(102.0)	94 HB
SRPE-625F-9-C	Natural Polyethylene	.625	(15.9)	.625	(15.9)	.062	(1.6)	.625	(15.9)	to	4.500	(114.3)	94 HB
SRPE-750F-9-C	Natural Polyethylene	.750	(19.1)	.750	(19.1)	.065	(1.7)	.750	(19.1)	to	5.000	(127.0)	94 HB
SRPE-1000F-9-C	Natural Polyethylene	1.000	(25.4)	1.110	(28.2)	.070	(1.8)	1.000	(25.4)	to	7.000	(177.8)	94 HB
SRPE-187F-0-C	UV Black Polyethylene	.187	(4.8)	.240	(6.1)	.040	(1.0)	.125	(3.2)	to	1.500	(25.9)	94 HB
SRPE-250F-0-C	UV Black Polyethylene	.250	(6.4)	.375	(9.5)	.045	(1.1)	.188	(4.8)	to	2.000	(50.8)	94 HB
SRPE-375F-0-C	UV Black Polyethylene	.375	(9.5)	.438	(11.1)	.052	(1.3)	.313	(7.9)	to	3.000	(76.2)	94 HB
SRPE-500F-0-C	UV Black Polyethylene	.500	(12.7)	.563	(14.3)	.062	(1.6)	.375	(9.5)	to	4.000	(102.0)	94 HB
SRPE-625F-0-C	UV Black Polyethylene	.625	(15.9)	.625	(15.9)	.062	(1.6)	.625	(15.9)	to	4.500	(114.3)	94 HB
SRPE-750F-0-C	UV Black Polyethylene	.750	(19.1)	.750	(19.1)	.065	(1.7)	.750	(19.1)	to	5.000	(127.0)	94 HB
SRPE-1000F-0-C	UV Black Polyethylene	1.000	(25.4)	1.110	(28.2)	.070	(1.8)	1.000	(25.4)	to	7.000	(177.8)	94 HB
SRFR-187F-WH-C	White Flame Retardant Polyethylene	.187	(4.8)	.240	(6.1)	.040	(1.0)	.125	(3.2)	to	1.500	(25.9)	94 V-0
SRFR-250F-WH-C	White Flame Retardant Polyethylene	.250	(6.4)	.375	(9.5)	.045	(1.1)	.188	(4.8)	to	2.000	(50.8)	94 V-0
SRFR-375F-WH-C	White Flame Retardant Polyethylene	.375	(9.5)	.438	(11.1)	.052	(1.3)	.313	(7.9)	to	3.000	(76.2)	94 V-0
SRFR-500F-WH-C	White Flame Retardant Polyethylene	.500	(12.7)	.563	(14.3)	.062	(1.6)	.375	(9.5)	to	4.000	(102.0)	94 V-0
SRTL-250-F-9-C	Teflon®	.250	(6.4)	.375	(9.5)	.030	(.76)	.188	(4.8)	to	2.000	(50.8)	94 V-0
SRTL-375-F-9-C	Teflon®	.375	(9.5)	.438	(11.1)	.030	(.76)	.313	(7.9)	to	3.000	(76.2)	94 V-0
SRTL-500-F-9-C	Teflon®	.500	(12.7)	.563	(14.3)	.030	(.76)	.375	(9.5)	to	4.000	(102.0)	94 V-0
SRTL-625-F-9-C	Teflon®	.625	(15.9)	.625	(15.9)	.030	(.76)	.625	(15.9)	to	4.500	(114.3)	94 V-0
SRTL-750-F-9-C	Teflon®	.750	(19.1)	.750	(19.1)	.030	(.76)	.750	(19.1)	to	5.000	(127.0)	94 V-0
Tolerance ±		.030	(.762)		.010	(.254)							

- Stocked in 100 foot rolls.

Polyethylene

For general indoor use to 122°F. Wrap is flexible and easy to work with.

UV Polyethylene

Available in black only. Designed to resist ultraviolet light in outdoor applications.

TEFLON®

PTFE Flexible Industrial Tubing meets or exceeds ASTM D 3295.
260°C
-240°C

Flame Retardant Polyethylene

Material is UL rated 94 V-0. More economical and less rigid than nylon.

Nylon 6/6

Offers highest abrasion resistance and rigidity. Self-extinguishing to UL 94 HB and a Recognized Component.

Ty-Rap®/Ty-Fast®

Thomas & Betts

Thomas & Betts

Wire Protection Products

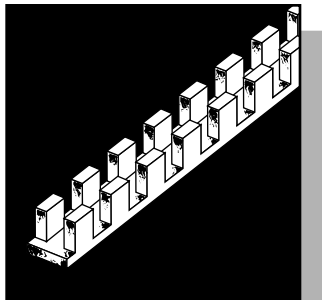

Molded Grommets

- Meets MS21266-(1-4)N.
- Available in 3 materials for panel thicknesses from .015" to .192".
- Grommet is used to protect panel edges and knock-outs where the chafing of passing wires is a concern.
- Suitable for round hole or odd shape applications.
- Also Available in DuPont Tefzel®.

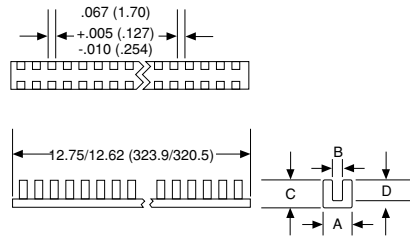

Cat. No.	Material	A		B		C		D		For Panel Thickness	Military Standard Numbers	Per Pkg.
		Inch	(mm)	Inch	(mm)	Inch	(mm)	Inch	(mm)			
GSNY-052-9-C	Natural Nylon	.150	(3.81)	.056	(1.42)					.015 (.381) to .052 (1.32)	MS-21266-1N	100
GSNY-085-9-C	Natural Nylon	.175	(4.44)	.090	(2.28)	.155	(3.93)	.100	(2.54)	.053 (1.34) to .085 (2.15)	MS-21266-2N	100
GSNY-128-9-C	Natural Nylon	.220	(5.58)	.131	(3.32)					.086 (2.18) to .128 (3.25)	MS-21266-3N	100
GSNY-192-9-C	Natural Nylon	.323	(8.20)	.192	(4.88)	.230	(5.84)	.162	(4.12)	.128 (3.25) to .192 (4.88)	MS-21266-4N	100
GSTZ-052-9-C	Natural Tefzel®	.150	(3.81)	.056	(1.42)					.015 (.381) to .052 (1.32)	-	100
GSTZ-085-9-C	Natural Tefzel®	.175	(4.44)	.090	(2.28)	.155	(3.93)	.100	(2.54)	.053 (1.34) to .085 (2.15)	-	100
GSTZ-128-9-C	Natural Tefzel®	.220	(5.58)	.131	(3.32)					.086 (2.18) to .128 (3.25)	-	100
GSTZ-192-9-C	Natural Tefzel®	.323	(8.20)	.192	(4.88)	.230	(5.84)	.162	(4.12)	.128 (3.25) to .192 (4.88)	-	100
Tolerance		+.015 -.005		(+.381 -.127)		+.020 -.005		(+.508 -.127)				

• Tefzel is a Trademark of the DuPont Corporation.

Ty-Rap®/Ty-Fast®

Thomas & Betts

Wire Protection Products

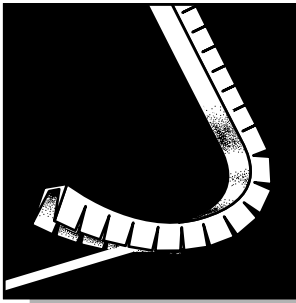

Extruded Grommeting

- Used to line panel edges and knock-outs where the chafing of passing wires is a concern.

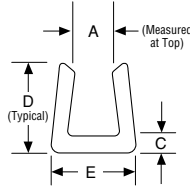

- Available in 8 stock sizes in 100 foot lengths for panels from .030" to .250" thick.
- A variety of stocked materials to cover a wide range of applications.
- Un-cut Polyethylene is ideal for protection of glass, sheet metal, wood panels or other sheet-form materials.
- In most applications, grommeting will grip tightly by itself. If not, a touch of epoxy will keep it in place.

Cat. No.	Material	A		C		D		E		UL Flammability
		Max. Panel Thickness Inch	(mm)	Inch	(mm)	Inch	(mm)	Inch	(mm)	
GRNY-040-9-C	Natural Nylon	.040	(1.01)	.040	(1.01)	.190	(4.82)	.125	(3.17)	94 V-2
GRNY-052-9-C	Natural Nylon	.052	(1.32)	.040	(1.01)	.190	(4.82)	.125	(3.17)	94 V-2
GRNY-062-9-C	Natural Nylon	.062	(1.57)	.045	(1.14)	.200	(5.08)	.170	(4.32)	94 V-2
GRNY-085-9-C	Natural Nylon	.085	(2.15)	.045	(1.14)	.200	(5.08)	.170	(4.32)	94 V-2
GRNY-100-9-C	Natural Nylon	.100	(2.54)	.045	(1.14)	.220	(5.58)	.210	(5.33)	94 V-2
GRNY-125-9-C	Natural Nylon	.125	(3.17)	.050	(1.27)	.220	(5.58)	.205	(5.23)	94 V-2
GRNY-187-9-C	Natural Nylon	.187	(4.74)	.050	(1.27)	.270	(6.85)	.275	(6.98)	94 V-2
GRNY-250-9-C	Natural Nylon	.250	(6.35)	.050	(1.27)	.280	(7.11)	.370	(9.39)	94 V-2
GRNY-040-0-C	Black Nylon	.040	(1.01)	.040	(1.01)	.190	(4.82)	.125	(3.17)	94 V-2
GRNY-052-0-C	Black Nylon	.052	(1.32)	.040	(1.01)	.190	(4.82)	.125	(3.17)	94 V-2
GRNY-062-0-C	Black Nylon	.062	(1.57)	.045	(1.14)	.200	(5.08)	.170	(4.32)	94 V-2
GRNY-085-0-C	Black Nylon	.085	(2.15)	.045	(1.14)	.200	(5.08)	.170	(4.32)	94 V-2
GRNY-100-0-C	Black Nylon	.100	(2.54)	.045	(1.14)	.220	(5.58)	.210	(5.33)	94 V-2
GRNY-125-0-C	Black Nylon	.125	(3.17)	.050	(1.27)	.220	(5.58)	.205	(5.23)	94 V-2
GRNY-187-0-C	Black Nylon	.187	(4.74)	.050	(1.27)	.270	(6.85)	.275	(6.98)	94 V-2
GRNY-250-0-C	Black Nylon	.250	(6.35)	.050	(1.27)	.280	(7.11)	.370	(9.39)	94 V-2
GRPE-040-9-C	Natural Polyethylene	.040	(1.01)	.040	(1.01)	.190	(4.82)	.125	(3.17)	94 HB
GRPE-052-9-C	Natural Polyethylene	.052	(1.32)	.040	(1.01)	.190	(4.82)	.125	(3.17)	94 HB
GRPE-062-9-C	Natural Polyethylene	.062	(1.57)	.045	(1.14)	.200	(5.08)	.170	(4.32)	94 HB
GRPE-085-9-C	Natural Polyethylene	.085	(2.15)	.045	(1.14)	.200	(5.08)	.170	(4.32)	94 HB
GRPE-100-9-C	Natural Polyethylene	.100	(2.54)	.045	(1.14)	.220	(5.58)	.210	(5.33)	94 HB
GRPE-125-9-C	Natural Polyethylene	.125	(3.17)	.050	(1.27)	.220	(5.58)	.205	(5.23)	94 HB
GRPE-187-9-C	Natural Polyethylene	.187	(4.74)	.050	(1.27)	.270	(6.85)	.275	(6.98)	94 HB
GRPE-250-9-C	Natural Polyethylene	.250	(6.35)	.050	(1.27)	.280	(7.11)	.370	(9.39)	94 HB
GRUPE-040-9-C	Un-Cut Polyethylene	.040	(1.01)	.040	(1.01)	.190	(4.82)	.125	(3.17)	94 HB
GRUPE-052-9-C	Un-Cut Polyethylene	.052	(1.32)	.040	(1.01)	.190	(4.82)	.125	(3.17)	94 HB
GRUPE-062-9-C	Un-Cut Polyethylene	.062	(1.57)	.045	(1.14)	.200	(5.08)	.170	(4.32)	94 HB
GRUPE-085-9-C	Un-Cut Polyethylene	.085	(2.15)	.045	(1.14)	.200	(5.08)	.170	(4.32)	94 HB
GRUPE-100-9-C	Un-Cut Polyethylene	.100	(2.54)	.045	(1.14)	.220	(5.58)	.210	(5.33)	94 HB
GRUPE-125-9-C	Un-Cut Polyethylene	.125	(3.17)	.050	(1.27)	.220	(5.58)	.205	(5.23)	94 HB
GRUPE-187-9-C	Un-Cut Polyethylene	.187	(4.74)	.050	(1.27)	.270	(6.85)	.275	(6.98)	94 HB
GRUPE-250-9-C	Un-Cut Polyethylene	.250	(6.35)	.050	(1.27)	.280	(7.11)	.370	(9.39)	94 HB
GRFR-040-WH-C	Flame Retardant Polyethylene	.040	(1.01)	.040	(1.01)	.190	(4.82)	.125	(3.17)	94 V-0
GRFR-052-WH-C	Flame Retardant Polyethylene	.052	(1.32)	.040	(1.01)	.190	(4.82)	.125	(3.17)	94 V-0
GRFR-062-WH-C	Flame Retardant Polyethylene	.062	(1.57)	.045	(1.14)	.200	(5.08)	.170	(4.32)	94 V-0
GRFR-085-WH-C	Flame Retardant Polyethylene	.085	(2.15)	.045	(1.14)	.200	(5.08)	.170	(4.32)	94 V-0
GRFR-100-WH-C	Flame Retardant Polyethylene	.100	(2.54)	.045	(1.14)	.220	(5.58)	.232	(5.33)	94 V-0
GRFR-125-WH-C	Flame Retardant Polyethylene	.125	(3.17)	.050	(1.27)	.220	(5.58)	.232	(5.32)	94 V-0
GRFR-187-WH-C	Flame Retardant Polyethylene	.187	(4.74)	.050	(1.27)	.270	(6.85)	.275	(6.98)	94 V-0
GRFR-250-WH-C	Flame Retardant Polyethylene	.250	(6.35)	.050	(1.27)	.280	(7.11)	.370	(9.39)	94 V-0
Tolerance		+ .000 - .015	(+ .000) (- .381)	± .007	(.178)	± .010	(.254)	+ .015 - .000	(+ .381) (- .000)	

• 100 feet per roll.



Thomas & Betts

Thomas & Betts

Braided Expandable Wire Sleeving



Product Description

Thomas & Betts braided expandable wire sleeving is used to bundle and protect wires and cables from abrasion and excessive wear. Its flexible, lightweight, open weave construction installs easily over a variety of bundle diameters and shapes. The sleeving is resistant to chemicals, fungus, fuels, UV sunlight and has an indefinite shelf life. It is

easily cut with a hot knife, which seals the end-preventing fraying. Ends can be secured using Ty-Rap® cable ties. Available in:

- either handy mini spools or bulk reels.
- eight sizes from 1/8" to 2 1/2" nominal I.D. size.
- solid or wraparound hook and loop braided expandable wire sleeving.

Types of Materials

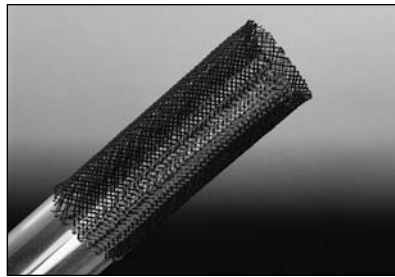

PET – Polyethylene terephthalate

A black 0.010" polyester monofilament material designed for indoor and outdoor applications. It is rated for continuous operating temp. -75°C to 125° C.

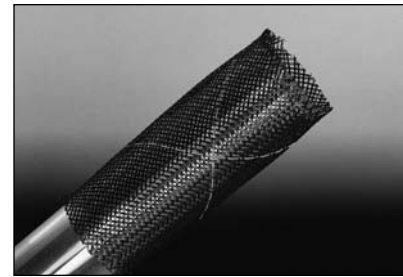

F – Flame Retardant Polyfibre-polyester

A 0.010" self-extinguishing polyester monofilament material that can be used indoors and outdoors. It is provided in black with white tracer for identification and is rated for continuous operating temp. -75°C to 125°C.

Catalog Number System

example, S250PM-0

S	250	P	M	O
Braided	Nominal	Material	Reel/Spool	Color
Expandable	I.D.	P = PET (Polyethylene Terephthalate)	Size	O = Weather Resistant
Wire	Size	F = Flame-retardant polyester	M = 1000 ft.	Black
Sleeving	125 = 1/8"	PW = PET hook & loop wrap-around sleeving.	D = 500 ft.	
	250 = 1/4"	FW = Flame retardant polyester hook & loop wrap-around sleeving	K = 250 ft.	
	500 = 1/2"		T = 200 ft.	
	750 = 3/4"		C = 100 ft.	
	1250 = 1 1/4"		L = 50 ft.	
	1750 = 1 3/4"			
	2000 = 2"			
	2500 = 2 1/2"			

Thomas & Betts

Thomas & Betts

Braided Expandable Wire Sleeving

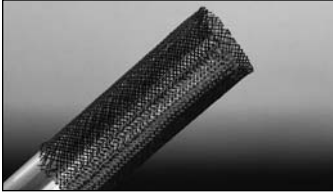

PET Braided Expandable Wire Sleeving – Mini Spool

Cat. No.	Nominal I.D. (in.)	Color	Nominal Diameter Range (in.)	Spool Quantity	Std. Pkg.
S250PT-0	.250		.125 to .375	200 ft.	1
S500PC-0	.500	Black	.250 to .750	100 ft.	1
S750PC-0	.750		.500 to 1.250	100 ft.	1
S1250PL-0	1.250		.750 to 1.750	50 ft.	1

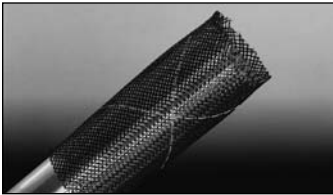

Flame Retardant Braided Expandable Wire Sleeving – Mini Spool

Cat. No.	Nominal I.D. (in.)	Color	Nominal Diameter Range (in.)	Spool Quantity	Std. Pkg.
S250FT-0	.250	Black	.125 to .375	200 ft.	1
S500FC-0	.500	with	.250 to .750	100 ft.	1
S750FC-0	.750	White	.500 to 1.250	100 ft.	1
S1250FL-0	1.250	Tracer	.750 to 1.750	50 ft.	1

Note: Order by spool, not per foot.

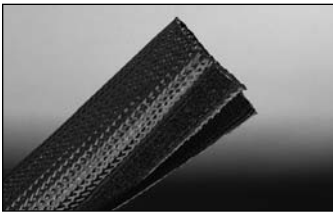

PET Hook and Loop, Wraparound Sleeving – Mini Spool

Cat. No.	Nominal I.D. (in.)	Color	Nominal Diameter Range (in.)	Spool Quantity	Std. Pkg.
S500PWL-0	.500		.250 to .750	50 ft.	1
S750PWL-0	.750	Black	.500 to 1.250	50 ft.	1
S1250PWL-0	1.250		.750 to 1.750	50 ft.	1
S2000PWL-0	2.000		1.500 to 3.500	50 ft.	1

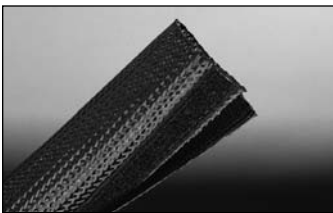

Flame Retardant Hook and Loop, Wraparound Sleeving – Mini Spool

Cat. No.	Nominal I.D. (in.)	Color	Nominal Diameter Range (in.)	Spool Quantity	Std. Pkg.
S500FWL-0	.500	Black	.250 to .750	50 ft.	1
S750FWL-0	.750	with	.500 to 1.250	50 ft.	1
S1250FWL-0	1.250	White	.750 to 1.750	50 ft.	1
S2000FWL-0	2.000	Tracer	1.500 to 3.500	50 ft.	1

Note: Order by spool, not per foot.

- Hook and loop fastener design allows for easy wrapping of existing wire harnesses and cables.
- Convenient for rework without disrupting existing connection.
- No tools required to close the sleeving.
- Hook and loop material is made of 100% nylon.

Ty-Rap®/Ty-Fast®

Thomas & Betts

Braided Expandable Wire Sleeving

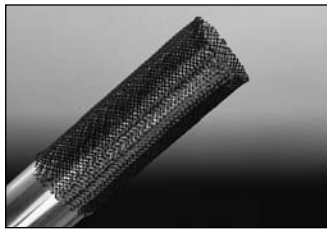

PET Braided Expandable Wire Sleeving – Bulk Reel

Cat. No.	Nominal I.D. (in.)	Color	Nominal Diameter Range (in.)	Reel Quantity	Std. Pkg.
S125PM-0	.125		.094 to .250	1000 ft.	1
S250PM-0	.250		.125 to .375	1000 ft.	1
S500PD-0	.500		.250 to .750	500 ft.	1
S750PK-0	.750	Black	.500 to 1.250	250 ft.	1
S1250PK-0	1.250		.750 to 1.750	250 ft.	1
S1750PT-0	1.750		1.250 to 2.750	200 ft.	1
S2000PT-0	2.000		1.500 to 3.500	200 ft.	1
S2500PT-0	2.500		1.750 to 4.500	200 ft.	1

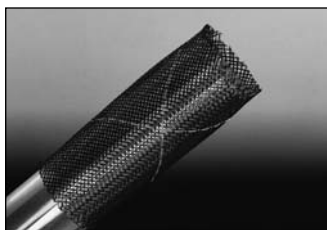

Flame Retardant Braided Expandable Wire Sleeving – Bulk Reel

Cat. No.	Nominal I.D. (in.)	Color	Nominal Diameter Range (in.)	Reel Quantity	Std. Pkg.
S125FM-0	.125		.094 to .250	1000 ft.	1
S250FM-0	.250	Black	.125 to .375	1000 ft.	1
S500FD-0	.500	with	.250 to .750	500 ft.	1
S750FK-0	.750	White	.500 to 1.250	250 ft.	1
S1250FK-0	1.250	Tracer	.750 to 1.750	250 ft.	1
S1750FT-0	1.750		1.250 to 2.750	200 ft.	1
S2000FT-0	2.000		1.500 to 3.500	200 ft.	1
S2500FT-0	2.500		1.750 to 4.500	200 ft.	1

Note: order by reel, not per foot.

For other colors, lengths, sizes and materials please contact customer service.

Sleeving End Cutter/Sealer Tools

Cat. No.	Description	Std. Pkg.
WTBM	Bench mount end cutter/sealer tool, 110 volt AC	1
WTHH	Handheld hot knife end cutter/sealer tool 100 watt, 120 volt, complete with cutting blade	1
WTHH-B	Cutting/sealing blade for dual straight shank soldering guns	1

It is recommended that the sleeving be cut with hot knife for a straight cut and to seal the ends which prevents fraying.

Ty-Rap®/Ty-Fast®



WTBM



WTHH



WTHH-B

Thomas & Betts

Thomas & Betts

Cable Tie Installation Tools



- A wider insertion gap means easier tie insertion.
- 360° rotating nose allows the Ty-Gun® tool to be used in any position.
- Quick tension-adjustment wheel is located towards the front for easy access and fast changes.
- Adjustable handle span fits large and small hands.
- Anti-recoil mechanism reduces vibration shock.
- Weighs only 8.5 ounces, with a well-balanced center of gravity.
- User friendly, smooth grip surface, with no sharp edges.

Ty-Gun® Cable Tie Tool Attaches Cables Quickly Without Leaving Your Hand In Knots.

Break-Through Ergonomic Design Dramatically Relieves Stress And Strain.

Thomas & Betts's Ty-Gun® cable tie tool is designed to reduce hand and wrist muscle fatigue while securing cable ties with just the right amount of tension. Plus, its unique anti-recoil mechanism virtually eliminates the shock associated with other cable tie installing tools.

The Ty-Gun® tool is a major advancement in cable tie installation: an ergonomic hand tool that gets the job done quickly and easily while substantially reducing the risks of carpal tunnel syndrome and other cumulative trauma disorders.

Lighter Weight And Adjustable Handle Span Help Reduce Fatigue.

The advanced material design of the Ty-Gun® tool delivers a lighter weight of just 8.5 ounces, far less than most steel tools. Plus, the Ty-Gun® tool's impact-resistant construction offers improved strength and a smoother fit and feel than conventional tools.

The exclusive adjustable handle span of almost one-half inch means a more comfortable grip for every size hand of both men and women. The Ty-Gun® tool's well-balanced center of gravity makes it rest easily in the operator's hand. And it requires a low handle force to secure cable ties with the right amount of tension,

from 18 to 120 pounds.



Quick Tension Adjustment Mechanism Saves Time And Energy.

Cable tie tension can be quickly adjusted in less than a second with just a half turn of the Ty-Gun® tool's tension setting wheel, conveniently located toward the front of the tool for easier access. (Most tools on the market take a full 8 to 10 seconds to adjust.) And the ingenious design and integrity of materials ensure durability.

Locked-Tension Mechanism Reduces Recoil Vibrations.

The Ty-Gun® tool's tension mechanism virtually eliminates the shock of unwanted recoil.

The Ty-Gun® Nose Rotates 360° For The Most Comfortable Operating Position.

The fully-rotating front of the Ty-Gun® tool means operators can always hold the tool in the most comfortable position, regardless of the angle or position of the cable ties. This extra versatility reduces the strain and injuries associated with making repetitive motions in unnatural positions.

Thoroughly Tested For Performance, Tie After Tie.

Field testing proves that the Ty-Gun® tool provides accurate tension and cleanly cuts off cable ties with an easy trigger action, even after 100,000 applications. The rotating nose and tension wheel have the durability you count on from Thomas & Betts.

For Maximum Performance, Select Thomas & Betts Ty-Rap® and Ty-Fast®.

Together, Ty-Rap®, Ty-Fast®, and One-Piece cable ties offer the most complete package of cable ties and accessories in the market. The ideal match for the new Ty-Gun® tool.

Ty-Rap®/Ty-Fast®

Cat. No.	Color	Tie Body Width
ERG 299	Black Handle:	18-50 lbs., .094-.184
ERG 297	Red Handle:	50-120 lbs., .184-.301
ED02041	Replacement Cutting Blade for ERG 297, ERG 299	-

Thomas & Betts

Thomas & Betts

Cable Tie Installation Tools



WT193A



WT199
WT197



WT1-TB



WT2-TB



WT3D
WT3S



DAS250

Installation Tools

WT193A Installation Tool

Cat. No.	Description	Body Width (in.)	Std. Pkg.	Wt. Each
WT193A	Pistol-type, easy tension adjustment, cuts tail off flush	.094-.184	1	10 oz.

WT199/WT197 Installation Tool

Cat. No.	Description	Body Width (in.)	Std. Pkg.	Wt. Each
WT197A	Pistol-type, easy tension adjustment, cuts tail off flush	.301	1	10 oz.
WT199A	Pistol-type, easy tension adjustment, cuts tail off flush	.094-.184	1	10 oz.

WT1-TB/WT2-TB Installation Tool

Lightweight, hand-operated cable tying tools install cable ties up to .301 inch wide and .080 inch thick. Made of high-impact plastic and steel to withstand shock and rough handling, they are symmetrical in design for use by both left-hand and right-hand operators.

They cinch up the tie with a squeeze action, and cut away the excess tail when twisted 180 degrees. A specially designed pawl cuts away the tail if the tension limit is exceeded, thereby preventing the cable tie from being over tightened. Ideally suited to spot-tying applications.

Cat. No.	Description	Body Width (in.)	Std. Pkg.	Wt. Each
WT1-TB	Compact hand tool made of high-impact plastic, preset tension, cuts off flush, lightweight and economical	.094 thru .184	1	1¼ oz.
WT2-TB		.184-.301	1	1¼ oz.

Ty-Rap® Deltec and Stainless Steel Tool

Cat. No.	Description	Body Width (in.)	Std. Pkg.	Wt. Each
WT3D	Installs self-locking Ty-Rap® cable ties and Thomas & Betts 2-piece lashing ties.	.184 thru .500	1	8 oz.
WT3S	Stainless steel cable tie installing tool.		1	8 oz.

Stainless Steel Installation Tool

Cat. No.	Description	Std. Pkg.
DAS250	Installation Tool for Stainless Steel Ties	1

Thomas & Betts

Thomas & Betts

Cable Tie Installation Tools

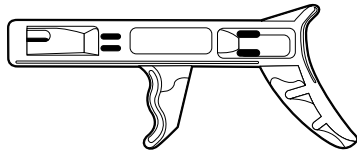

QC-100 (plastic)

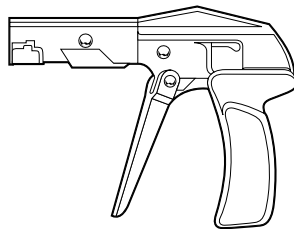

L-200 Metal (steel)

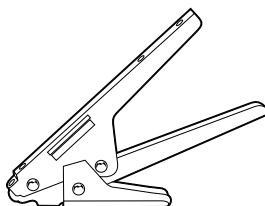

L-300C Metal (steel)

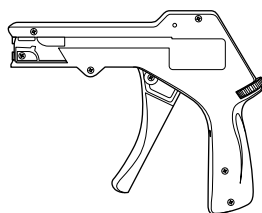

L-400-C (plastic)

Cable Tie Tool

QC-100

A lightweight tool for least critical applications. Cinch tie to desired bundle and twist tool to remove excess strap. Recommended for use with 18 - 50 pound ties.

Cat. No.	Description	Tie Body Width	Std. Pkg.	Wt. Ea.
QC-100	Cable Tie Tool, 18-50 lbs. tension Plastic Handle	.094-.184"	1	2.56 oz.

L-200

Economy tool for use with 18 - 50 pound ties. Automatic cut-off removes excess strap flush against cable tie head. Tool is equipped with adjustable tensioning.

Cat. No.	Description	Tie Body Width	Std. Pkg.	Wt. Ea.
L-200	Cable Tie Tool, 18-50 lbs. tension Steel Handle	.094-.184"	1	13.44 oz.

L-300-C

Rugged construction makes this tool ideal for use with our 120 - 175 pound ties. Cinch tie to desired bundle and pull trigger to cut excess flush at Cable Tie head. Field proven durability.

Cat. No.	Description	Tie Body Width	Std. Pkg.	Wt. Ea.
L-300C	Cable Tie Tool, 120-175 lbs. tension Steel Handle	.301-.345"	1	12 oz.

L-400-C

Heavy Duty tool for use with 18 - 50 pound ties. Automatic cut-off and adjustable tensioning for dependable use in assembly applications.

Cat. No.	Description	Tie Body Width	Std. Pkg.	Wt. Ea.
L-400-C	Cable Tie Tool, 18-50 lbs. tension Plastic Handle	.094-.184"	1	7.52 oz.



Ty-Rap®/Ty-Fast®

Thomas & Betts

Thomas & Betts

Cable Tie Installation Tools

Semi-automatic air tool speeds cable tying operation – increases productivity



TR227
TR227R

- Semi-automatic operation—produces fast, effortless tying; cinches and trims tie in one fast motion
- Positive tail ejection—ensures high operating efficiency
- Precision engineered—gives you long-term dependable service, reduces operator fatigue
- Adjustable tension—provides uniform, quality installations over wide bundle diameter range

The TR227 pistol-type, semiautomatic air tool provides quick, effortless cable tying. It installs self-locking Ty-Rap® cable ties having body widths of .091" to .187" regardless of the tie's length or diameter of the wire bundle.

The trigger activated pneumatic tool:

1. tightens the tie to a preset tension,
2. trims it flush to the head,
3. positively ejects the cut-off portion of the cable tie in a single stroke.

The tool is so easy to operate that just installing a few ties is all the training required. This lightweight, precision tool is designed to be the workhorse in production tying operations. Its long barrel and narrow nose make it ideal for reaching into congested wire areas.

Designed with a comfort-grip handle to avoid operator fatigue, the tool is quality engineered to provide years of dependable service. Your wire harnessing and cable bundling will be accomplished quickly, easily, and at low installed cost.

Consistent tension for all bundle diameters

The tool has a convenient tension adjustment permitting each tie to be installed with the proper tension regardless of variations in the bundle diameter. To increase tension on the tie, turn the tension disc clockwise—to decrease tension, turn the disc counterclockwise.

The tension range is indicated on the disc from min. to max.

Modular head

If difficulty should arise with operation of the tool, a convenient modular head allows quick replacement. Simple on-line repair—downtime reduced to an absolute minimum.

Ty-Rap® Pneumatic Tool

Cat. No.	Description	Body Width (in.)
TR227	Semiautomatic hand tool	.094-.184
TR227R	For TR227	Replaceable head

Thomas & Betts

Ty-Rap®/Ty-Fast®

Thomas & Betts

Cable Tie Installation Tools



Designed To Make A Fast Bundle—On The Job And On The Bottom Line.

Thomas & Betts analyzed the harness assembly process in detail to develop the new Ty-Fast® Automated Fastening System with features you need and the reliability you demand.

Reliable Performance Tie After Tie.

The Ty-Fast® Automated Fastening

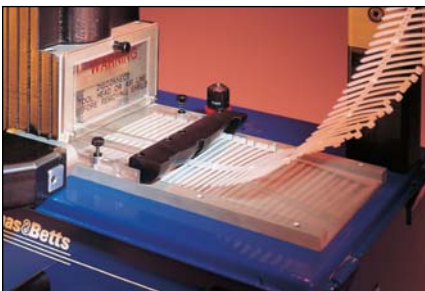

System is precision engineered for enhanced reliability.

- Dispenser, tool head, and cable ties are designed to work smoothly and swiftly together.
- Simplicity of concept virtually eliminates costly jams in the hose and dispenser.

- Compact dispenser takes up less room—allows automation in tight spaces.
- Using compressed air, cable ties are fully installed in less than one second.
- Cable tie reels allow extra room for loading and feeding.
- Top-mounted scrap catcher opens to the side to empty quickly and easily.
- Tension adjustment knob ensures a secure bundle every time.

Ergonomic Design That's Easier To Handle.

The Ty-Fast® system features a number of ergonomic advantages to reduce fatigue and enhance performance.

- Smaller grip on tool head provides comfortable fit.
- Center of gravity balanced for optimum operation at panel-standard 20° angle.

- Swivel handle provides easier movement around the harness application.
- Lightweight tool head reduces operator fatigue.

T&B Cable Ties For Superb Locking Strength.

The Ty-Fast® Automatic Fastening System uses Thomas & Betts all nylon cable ties, specially designed for smooth operation and rugged, long-lasting use.

- Quality molded nylon ties prevent damage to wire insulation.
- Integrally formed nylon pawl combines low insertion resistance and high locking strength.

Guaranteed Service

Sure-Service Tool Support For Quick Response Service.

Although you shouldn't expect a problem with the Ty-Fast® system, it's still nice to know that every unit comes with Sure-Service Tool Support, a comprehensive warranty and service contract that keeps you up and running.

- On-site set up and training makes start-up easy.
- Direct access to professionally trained technicians keeps your system in tip-top shape. 1-800-284-TOOL.
- Our affordable lease option reduces your capital expenditure and ensures a rapid payback on your investment.



Thomas & Betts

Ty-Rap®/Ty-Fast®

Thomas & Betts

Cable Tie Installation Tools



Figure A



Figure B



Figure C



TC100ASH



TC2FR



Cable Ties

A Complete Cable Tie System For Harness Assembly.

The Ty-Fast® system includes everything you need for fast, reliable performance for all types of harness assembly applications. It's the latest innovation from the company that introduced the very first cable tie in 1958 and the original automatic cable tool in 1970. What's more, Thomas & Betts brings you the convenience of a

single source for a complete solution to all your cable tie needs, with all the dependability, service and reputation of our name behind it.

For more information about the Ty-Fast® Automated Fastening System, talk to your Thomas & Betts Sales Representative.

Ordering Information

Cat. No.	Figure	Description
Complete System		
ERG 502	A	Complete cable tie installation system consisting of:
	B	Tool Head (ERG 502H)
	C	10' Cable Tie Delivery Hose (TC100H) Cable Tie Dispenser (ERG 502D) (Each of these parts is also available separately for replacement.)

Additional Components

TC100ASH	Main Air Supply Hose 10' hose provides for connection from TC2FR Filter/Regulator to ERG 502D Cable Tie Dispenser
TC2FR	Filter/Regulator Supplies the ERG 502D dispenser with clean air and allows for regulation of air pressure.

Cable Ties

Cat. No.	Color	Max. Bundle Diameter In. (mm)	Tie Length In. (mm)	Tie Width In. (mm)	Min. Loop Tensile Strength Lbs. (N)	Use With T&B Tool Cat. No.
TY910	Natural					
TY910X	Weatherable Black					
TY910-11	White					
TY910-1	Brown					
TY910-2	Red					
TY910-3	Orange					
TY910-4	Yellow	.06 - .87 (1.5 - 22.1)	4.14 (105.2)	.095 (2.4)	18 (80)	ERG 502
TY910-5	Green					
TY910-6	Blue					
TY910-7	Purple					
TY910-8	Gray					
TY910-HS	Heat Stabilized Natural					
TY910-XHS	Heat Stabilized Black					

Cable tie reel (5000 cable ties per reel)
6/6 Nylon for indoor use up to 185°F (85°C)
Heat stabilized nylon for use up to 221°F (105°C)

Thomas & Betts

X-ON Electronics

Largest Supplier of Electrical and Electronic Components

Click to view similar products for [Wire Identification category](#):

Click to view products by [ABB manufacturer](#):

Other Similar products are found below :

[CU6337-000](#) [CU6342-000](#) [FCA-410-12](#) [11631010](#) [1-1768037-1](#) [1-1768037-2](#) [1-1768050-0](#) [PXLK-VI](#) [Q62184-1](#) [A64304-000](#) [QMT221](#)
[HK032WE1NF038B](#) [1330-0519-10](#) [1395199-1](#) [1395200-1](#) [1395202-1](#) [DMVF050WE-300S6](#) [D-SCE-1K-2.4-50-4-CS7834](#) [1538738-1](#)
[E90935-000](#) [EC1238-000](#) [EC1465-000](#) [EC1855-000](#) [EC1859-000](#) [EC1863-000](#) [EC5415-000](#) [EC7277-000](#) [EC7352-000](#) [EC7603-000](#)
[EC7707-000](#) [EC7735-000](#) [EC7768-000](#) [EC7828-000](#) [EC7854-000](#) [EC7952-000](#) [EC8128-000](#) [1768037-8](#) [1768041-7](#) [NC-127191-10-9](#)
[HS048WE2NF038B](#) [C03232-000](#) [HTCM-SCE-14-4H-9](#) [HTMS-3/16-9](#) [HT-SCE-1/4-2.0-4](#) [HT-SCE-3/16-2.0-4](#) [HTTMS-1/2-1.50-9](#) [HTTMS-](#)
[CM-1/2-4H-9](#) [HX-SCE-19.0-50-9](#) [HX-SCE-6.4-50-4](#) [C25254-000](#)