

LOC	DIST	REVISIONS			
P	LTN	DESCRIPTION	DATE	DMN	APVD
E1		ADD 3-6450140-4	02APR2011	OL	SZ
E2		REV PER ECR-11-008606	29APR2011	OL	SZ
E3		ADDED NEW DASH NUMBER 3-5 AND 3-6	09MAR2012	CZ	SZ
E4		REVISED	23APR2012	CZ	SZ

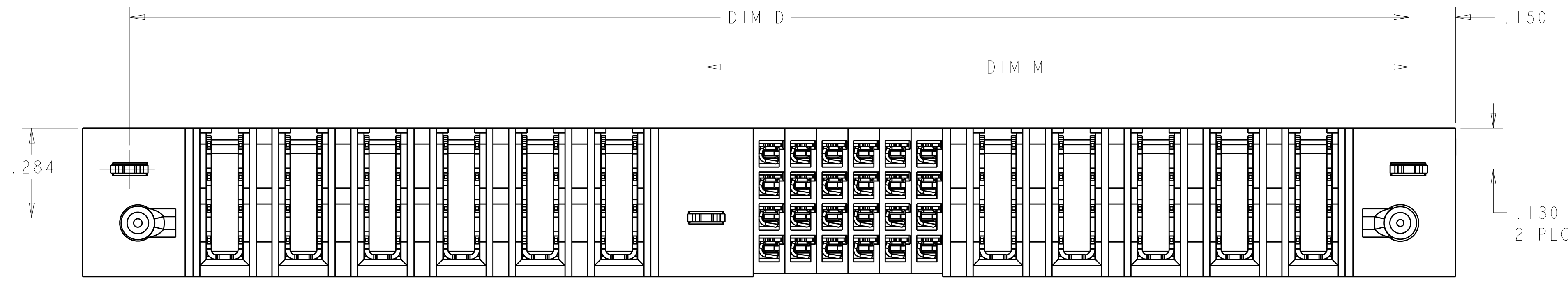

- △ OPTIONAL CENTER MODULE, WITH Ø.150 THRU HOLE OR HOLD DOWN FEATURE
- △ "AMP", TRADEMARK, PART NUMBER AND DATE CODE TO BE MARKED IN AREA SHOWN.
- △ MATERIAL: HOUSING - GLASS FILLED HIGH TEMP THERMO PLASTIC, UL94 V-0
SIGNAL CONTACT - HIGH CONDUCTIVITY COPPER ALLOY
POWER CONTACT - HIGH CONDUCTIVITY COPPER ALLOY
- △ CONTACT PLATING: NOBLE METAL PLATING ON CONTACT FUNCTIONAL AREA OF POWER AND SIGNAL CONTACTS
- △ MECHANICAL CONNECTOR KEEP OUT ZONE
- △ DATUM AND BASIC DIMENSIONS ESTABLISHED BY CUSTOMER
- △ PCB - ALL HOLE DIAMETERS ARE FINISHED HOLE SIZES
- △ PCB - .0453±.0010 DRILLED HOLES PLATED WITH .0003 MIN Sn OVER .001 TO .003 Cu PLATING TO ACHIEVE A .040 HOLE

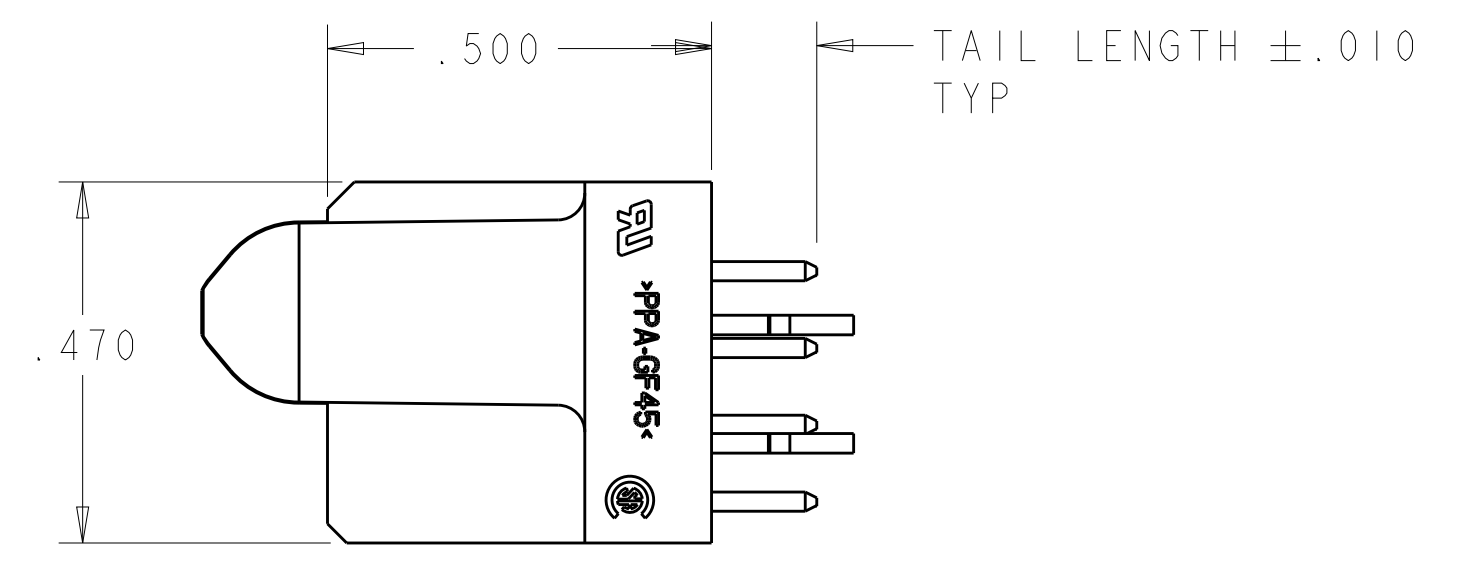
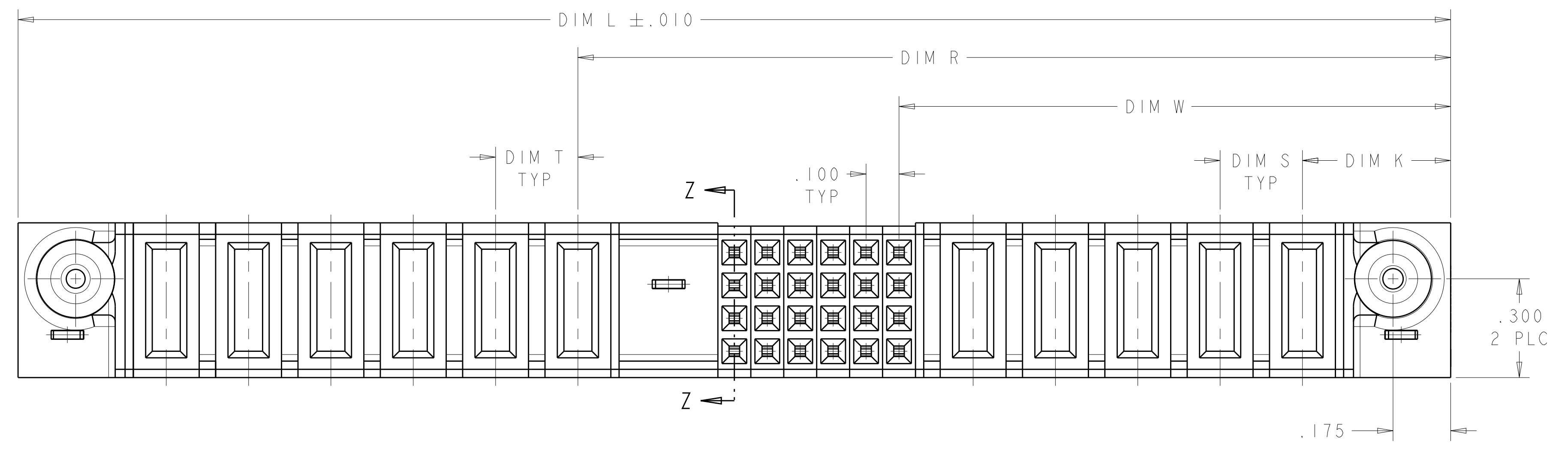
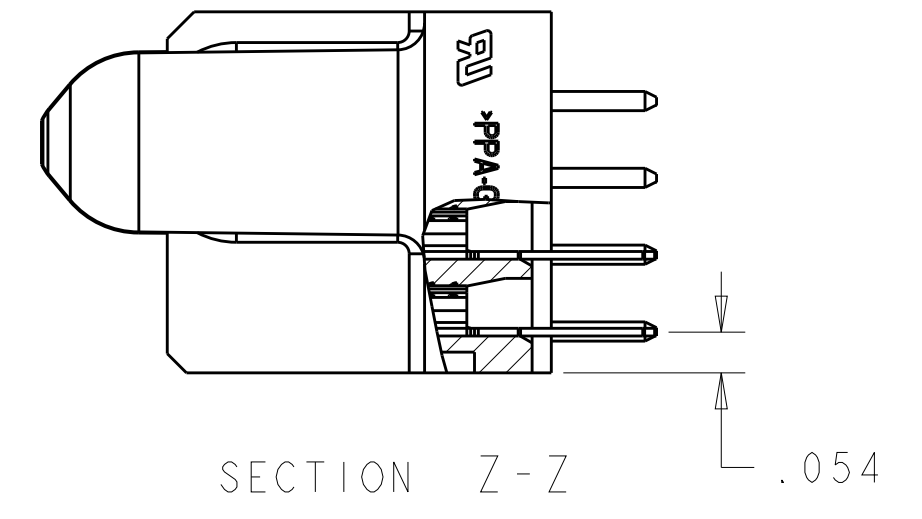
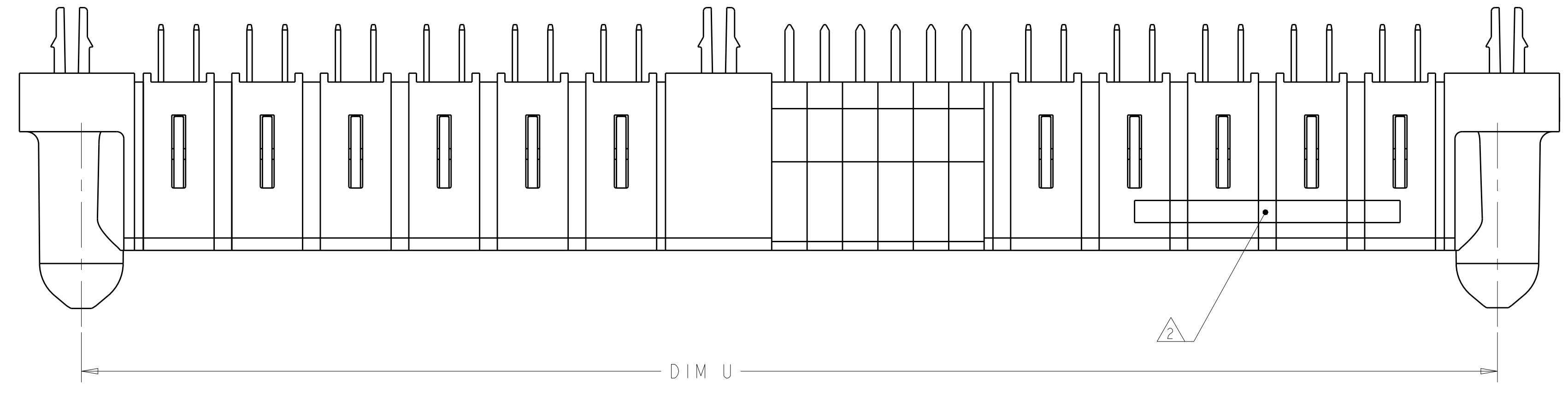

THIS DRAWING IS A CONTROLLED DOCUMENT.		DMN: R.GRZYBOWSKI 15FEB05	TE Connectivity
DIMENSIONS: INCHES		CHK: M.PERCHEKKE 15FEB05	
TOLERANCES UNLESS OTHERWISE SPECIFIED:		APVD: M.PERCHEKKE	NAME: VERTICAL RECEPTACLE ASSEMBLY WITH GUIDES MULTI-BEAM XL
0 PLC ±.01	1 PLC ±.01	PRODUCT SPEC: 108-1973	SIZE: A1
2 PLC ±.005	3 PLC ±.005	APPLICATION SPEC: 114-13038	CAGE CODE: C=6450140
4 PLC ±.0020	ANGLES ±.7°	WEIGHT: -	RESTRICTED TO: -
MATERIAL: -	FINISH: -	CUSTOMER DRAWING	SCALE: 2:1 SHEET 1 OF 11 REV: E4

THIS DRAWING IS UNPUBLISHED. RELEASED FOR PUBLICATION 20
 © COPYRIGHT 20 BY - ALL RIGHTS RESERVED.

LOC	DIST	REVISIONS					
		P	LTN	DESCRIPTION	DATE	DWN	APVD
ES	00	-	-	SEE SHEET 1	-	-	-

1.575	-	-	1.425	.700	1.625	-	1.925	.475	1P + 24S + 1P	3-6450140-6
1.575	-	-	1.425	.700	1.625	-	1.925	.475	1P + 24S + 1P	3-6450140-5
2.700	.250	.250	2.100	1.125	2.750	-	3.050	.450	3P + 36S + 3P	3-6450140-4
3.200	.250	.250	2.350	1.375	3.250	-	3.550	.450	4P + 36S + 4P	3-6450140-1
3.500	.250	.250	2.150	1.875	3.550	-	3.850	.450	6P + 8S + 6P	3-6450140-0
2.500	.250	.250	1.650	1.375	2.550	-	2.850	.450	4P + 8S + 4P	2-6450140-9
2.900	.250	.250	2.050	1.375	2.950	-	3.250	.450	4P + 24S + 4P	2-6450140-8
2.400	.250	.250	2.050	1.375	2.450	-	2.750	.450	4P + 24S + 2P	2-6450140-7
3.700	.300	.200	2.700	2.025	3.750	-	4.050	.450	8P + 24S + 4ACP	2-6450140-6
2.400	.250	.250	1.800	1.125	2.450	-	2.750	.450	3P + 24S + 3P	2-6450140-5
1.900	.250	.250	1.550	.875	1.950	-	2.250	.450	2P + 24S + 2P	2-6450140-0
2.600	.200	.200	1.900	1.225	2.650	-	2.950	.450	4HDP + 24S + 4HDP	1-6450140-9
1.700	.250	.250	1.350	.875	1.750	-	2.050	.450	2P + 16S + 2P	1-6450140-8
4.500	.250	.250	2.900	2.125	4.550	-	4.850	.450	7P + 28S + 7P	1-6450140-3
4.250	.250	.250	2.650	1.875	4.300	-	4.600	.450	6P + 28S + 7P	1-6450140-2
2.800	.250	.250	1.950	1.375	2.850	-	3.150	.450	4P + 20S + 4P	1-6450140-1
2.400	.250	.250	1.800	1.125	2.450	-	2.750	.450	3P + 24S + 3P	1-6450140-0
4.000	.250	.250	2.650	1.675	4.050	2.225	4.350	.450	5P+24S+1M+6P	6450140-9
4.150	.250	.250	2.800	2.125	4.200	-	4.500	.450	7P + 24S + 6P	6450140-8
4.350	.250	.250	3.500	2.625	4.400	-	4.700	.450	9P + 32S + 4P	6450140-7
1.575	-	-	1.425	.700	1.625	-	1.925	.475	1P + 24S + 1P	6450140-6
1.900	.250	.250	1.550	.875	1.950	-	2.250	.450	2P + 24S + 2P	6450140-5
7.400	.250	.250	5.050	2.875	7.450	-	7.750	.450	10P + 84S + 10P	6450140-4
3.650	.250	.250	2.550	1.875	3.700	-	4.000	.450	6P + 24S + 5P	6450140-3
4.350	.250	.250	3.000	2.125	4.400	-	4.700	.450	7P + 32S + 6P	6450140-2
5.100	.250	.250	3.250	2.375	5.150	-	5.450	.450	8P + 32S + 8P	6450140-1
U	T	S	R	W	D	M	L	K	DESCRIPTION	PART NUMBER

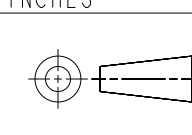
THIS DRAWING IS A CONTROLLED DOCUMENT.		DWN R. GRZYBOWSKI 15FEB05	 TE Connectivity
DIMENSIONS: INCHES		CHK M. PERCHERKE 15FEB05	
TOLERANCES UNLESS OTHERWISE SPECIFIED: 0 PLC ±. 1 PLC ±.01 2 PLC ±.01 3 PLC ±.005 4 PLC ±.002 ANGLES ±.020		APVD M. PERCHERKE	NAME VERTICAL RECEPTACLE ASSEMBLY WITH GUIDES MULTI-BEAM XL
		PRODUCT SPEC 108-1973	RESTRICTED TO
MATERIAL		APPLICATION SPEC 114-13038	SIZE A100779
FINISH		WEIGHT	CAGE CODE DRAWING NO 6450140
		CUSTOMER DRAWING	SCALE 2:1 SHEET 2 OF 11 REV E4

LOC	DIST	REVISIONS			
P	LTN	DESCRIPTION	DATE	DMN	APVD
ES	00	SEE SHEET 1			

PART NUMBER	ROWS	POWER							SIGNAL							POWER													
		P16	P15	P14	P13	P12	P11	P10	P9	8	7	6	5	4	3	2	1	P8	P7	P6	P5	P4	P3	P2	P1				
6450140-1	D C B A	VA	VA	VA	VA	VA	VA	VA	E	E	E	E	E	E	E	E	VA	VA	VA	VA	VA	VA	VA	VA					
		9P + 32S + 8P																											

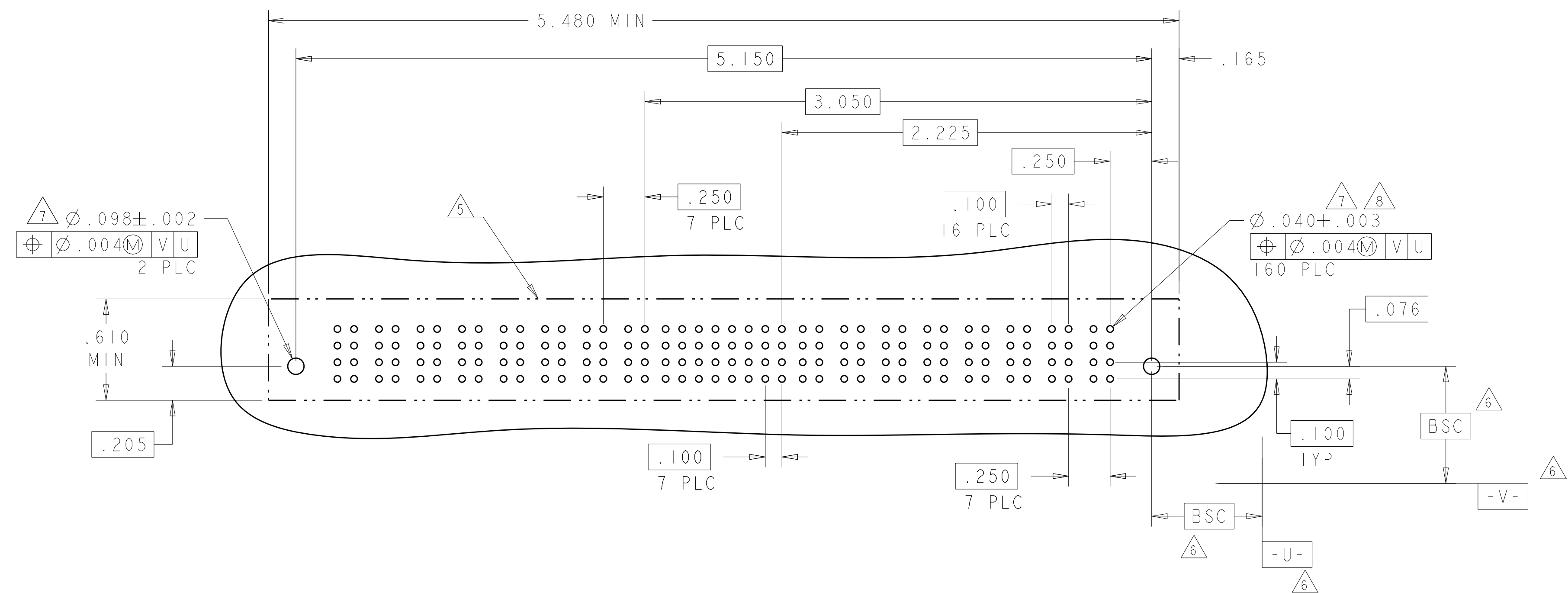

PART NUMBER	ROWS	POWER							SIGNAL							POWER													
		P13	P12	P11	P10	P9	P8	8	7	6	5	4	3	2	1	P7	P6	P5	P4	P3	P2	P1							
6450140-2	D C B A	VA	VA	VA	VA	VA	VA	E	E	E	E	E	E	E	VA	VA	VA	VA	VA	VA	VA	VA							
		7P + 32S + 6P																											

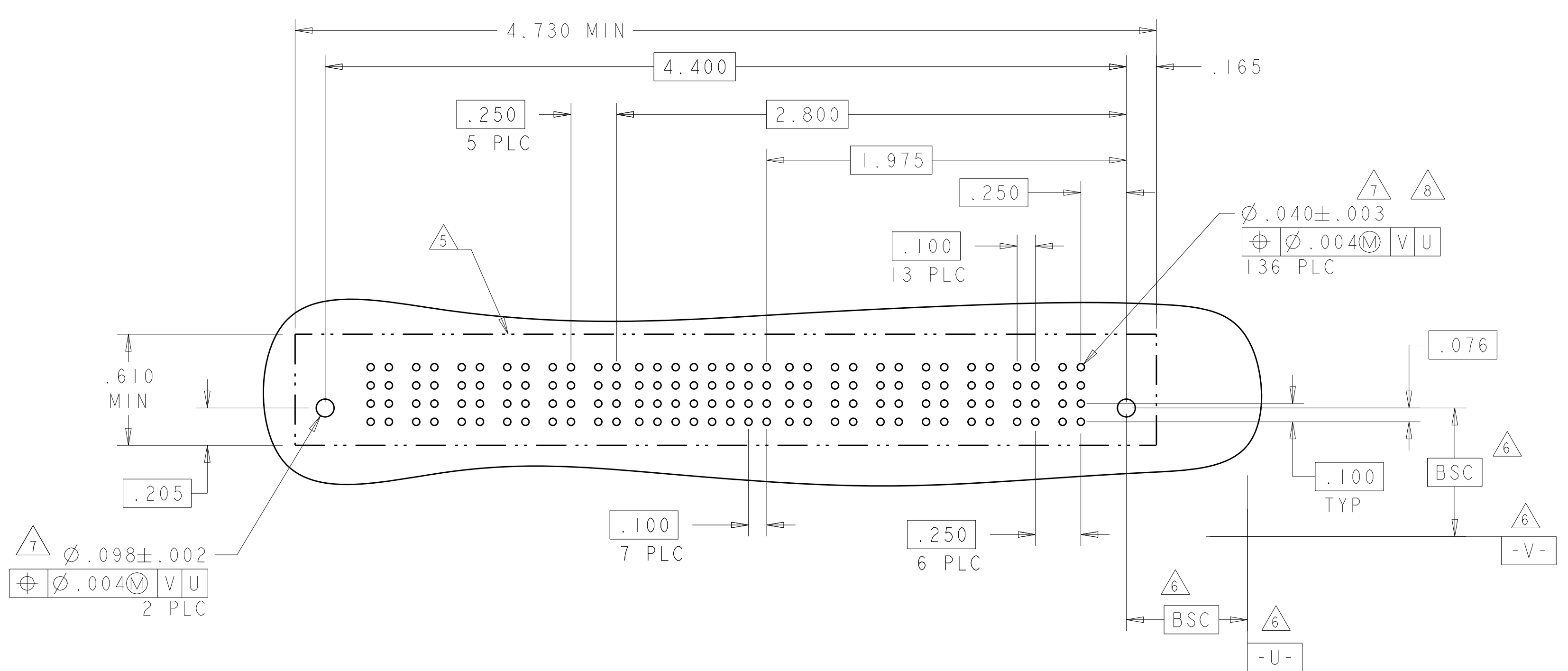

CODE	TAIL LENGTH	DESCRIPTION
VB	.090	MFBL
VM	.135	STD
VA	.135	MFBL
POWER CONTACT		

CODE	TAIL LENGTH	DESCRIPTION
J	.090	
E	.135	
SIGNAL CONTACT		

THIS DRAWING IS A CONTROLLED DOCUMENT. DWN: R. GRZYBOWSKI 15FEB05, CHK: M. PERCHERKE 15FEB05, APVD: M. PERCHERKE. NAME: VERTICAL RECEPTACLE ASSEMBLY WITH GUIDES MULTI-BEAM XL. DIMENSIONS: INCHES. TOLERANCES UNLESS OTHERWISE SPECIFIED: 0 PLC ±.01, 1 PLC ±.01, 2 PLC ±.01, 3 PLC ±.005, 4 PLC ±.0020, ANGLES ±.2°. MATERIAL: FINISH: WEIGHT: CUSTOMER DRAWING. SCALE: 2:1. SHEET 3 OF 11. REV: E4.

LOC	DIST	REVISIONS			
ES	00	REV	DATE	BY	APPD
		1	SEE SHEET 1		

PART NUMBER	ROWS	POWER					SIGNAL					POWER									
		P2	6	5	4	3	2	1	P1	P2	6	5	4	3	2	1	P1				
6450140-6	D C B A	VA	VA	VA	VA	VA	VA	VA	VA	VA	VA	VA	VA	VA	VA	VA	VA	VA	VA	VA	VA
		VA	VA	VA	VA	VA	VA	VA	VA	VA	VA	VA	VA	VA	VA	VA	VA	VA	VA	VA	VA

IP + 24S + IP

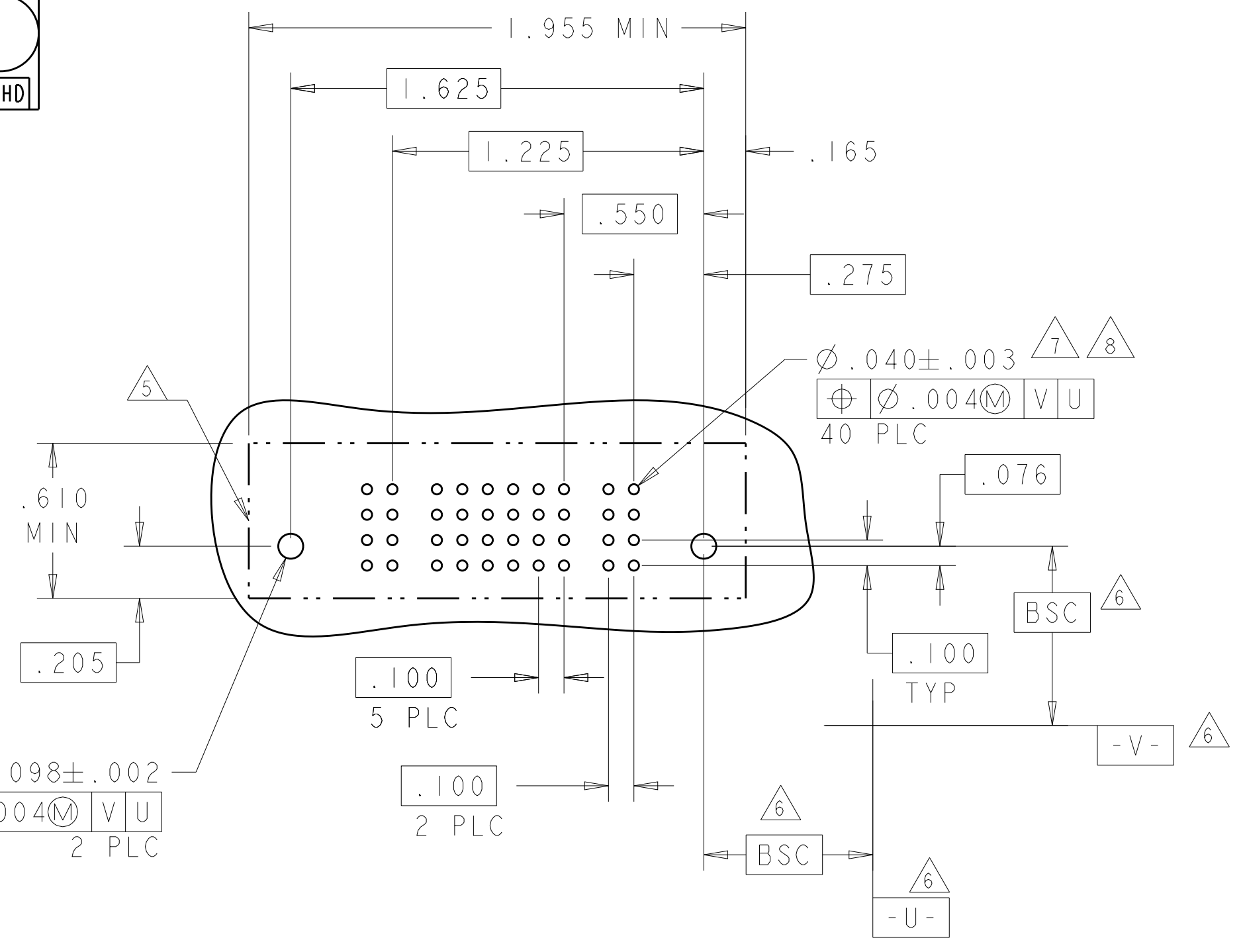

PART NUMBER	ROWS	POWER					SIGNAL					POWER									
		P13	P12	P11	P10	P9	P8	6	5	4	3	2	1	P7	P6	P5	P4	P3	P2	P1	
6450140-8	D C B A	VA	VA	VA	VA	VA	VA	VA	VA	VA	VA	VA	VA	VA	VA	VA	VA	VA	VA	VA	VA
		VA	VA	VA	VA	VA	VA	VA	VA	VA	VA	VA	VA	VA	VA	VA	VA	VA	VA	VA	VA

7P + 24S + 6P

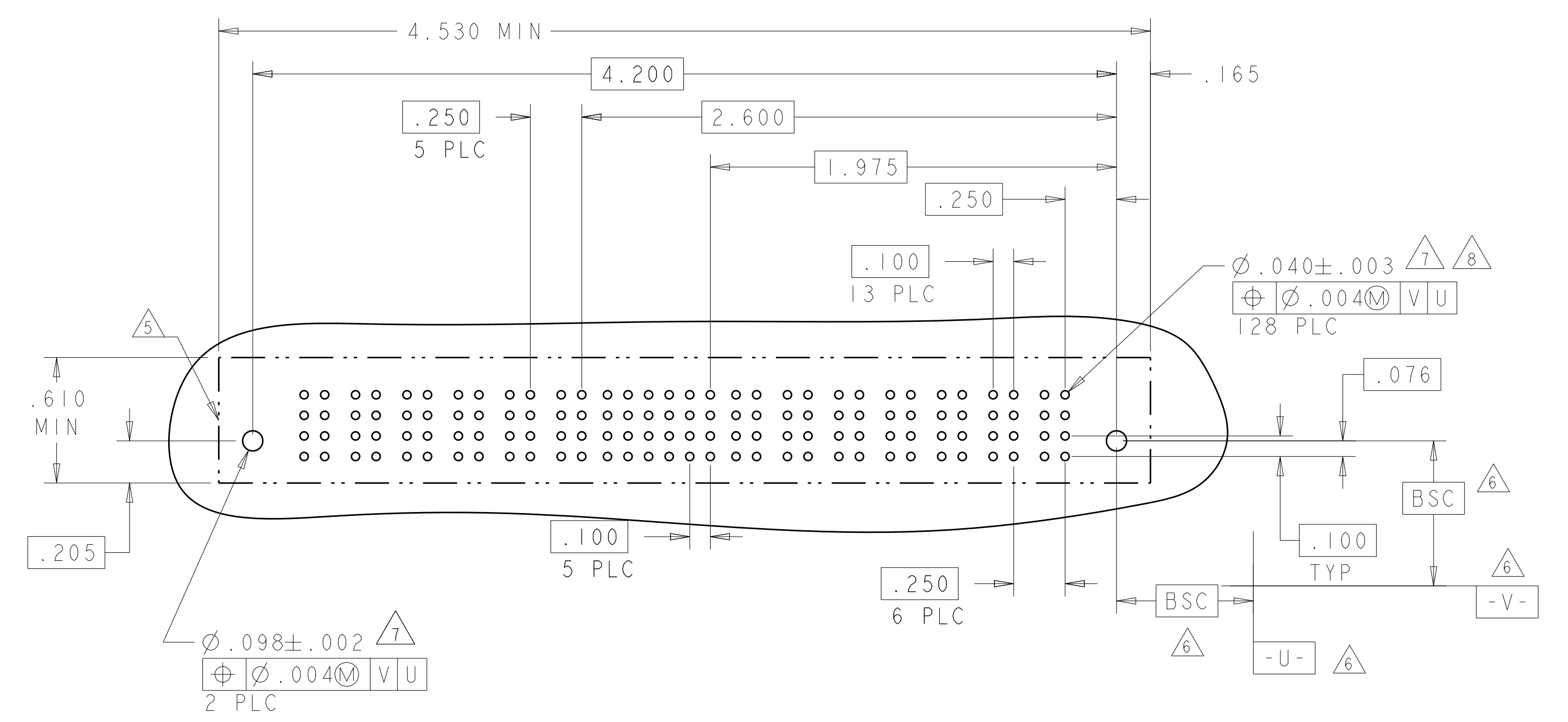

PART NUMBER	ROWS	POWER					SIGNAL								POWER												
		P13	P12	P11	P10	8	7	6	5	4	3	2	1	P9	P8	P7	P6	P5	P4	P3	P2	P1					
6450140-7	D C B A	VA	VA	VA	VA	VA	VA	VA	VA	VA	VA	VA	VA	VA	VA	VA	VA	VA	VA	VA	VA	VA	VA	VA	VA	VA	VA
		VA	VA	VA	VA	VA	VA	VA	VA	VA	VA	VA	VA	VA	VA	VA	VA	VA	VA	VA	VA	VA	VA	VA	VA	VA	VA

J2 + 36S + 4P

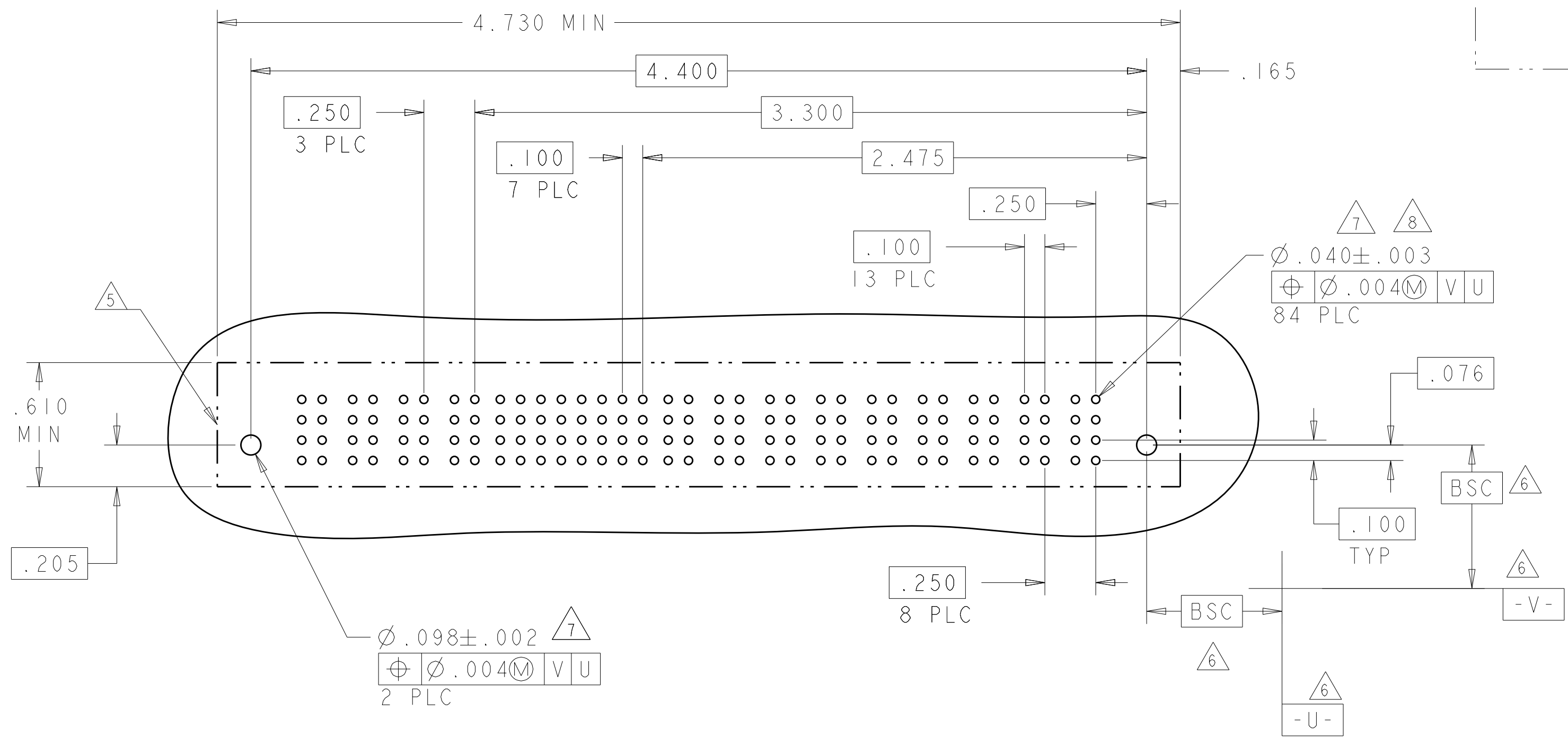

THIS DRAWING IS A CONTROLLED DOCUMENT.

DIMENSIONS: INCHES	TOLERANCES UNLESS OTHERWISE SPECIFIED: 0 PLC ±. 1 PLC ±.01 2 PLC ±.01 3 PLC ±.005 4 PLC ±.0020 ANGLES ±.2°	DWN: R. GRZYBOWSKI CHK: M. PERCHERKE APVD: M. PERCHERKE PRODUCT SPEC: 108-1973 APPLICATION SPEC: 114-13038 WEIGHT: - CUSTOMER DRAWING	15FEB05 15FEB05 NAME: VERTICAL RECEPTACLE ASSEMBLY WITH GUIDES MULTI-BEAM XL SIZE: A1 CAGE CODE: 100779 DRAWING NO: 6450140 SHEET 5 OF 11 REV E4	TE Connectivity
-----------------------	--	---	---	-----------------

SCALE: 2:1

PART NUMBER	ROWS	POWER								SIGNAL								POWER							
		P14	P13	P12	P11	P10	P9	P8	7	6	5	4	3	2	1	P7	P6	P5	P4	P3	P2	P1			
1-6450140-3	D C B A	VA	VA	VA	VA	VA	VA	VA	VA	E	E	E	E	E	E	VA	VA	VA	VA	VA	VA	VA			
7P + 28S + 7P																									

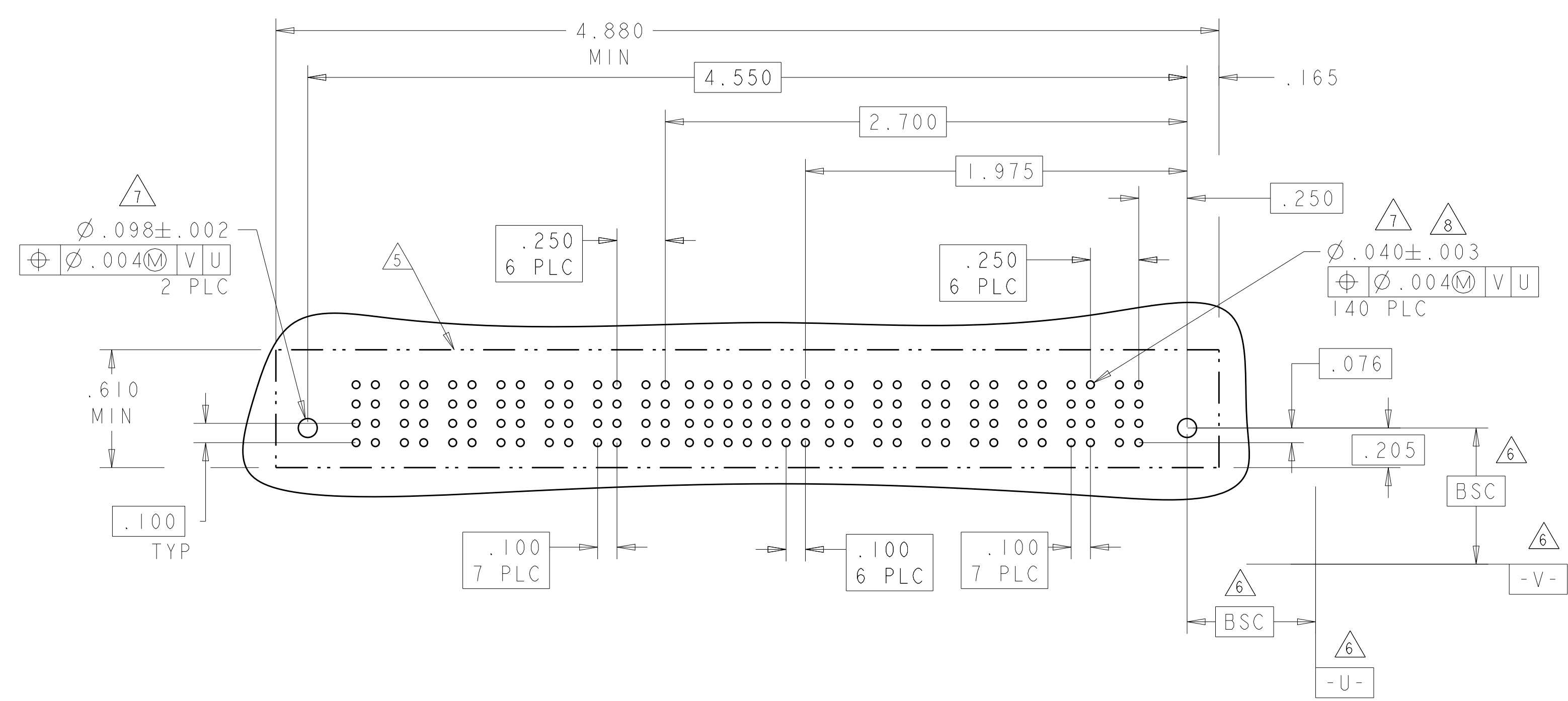

PART NUMBER	ROWS	POWER					SIGNAL					POWER				
		P8	P7	P6	P5	6	5	4	3	2	1	P4	P3	P2	P1	
1-6450140-9	D C B A	VA	VA	VA	VA	VA	E	E	E	E	E	VA	VA	VA	VA	
4HDP + 24S + 4HDP																

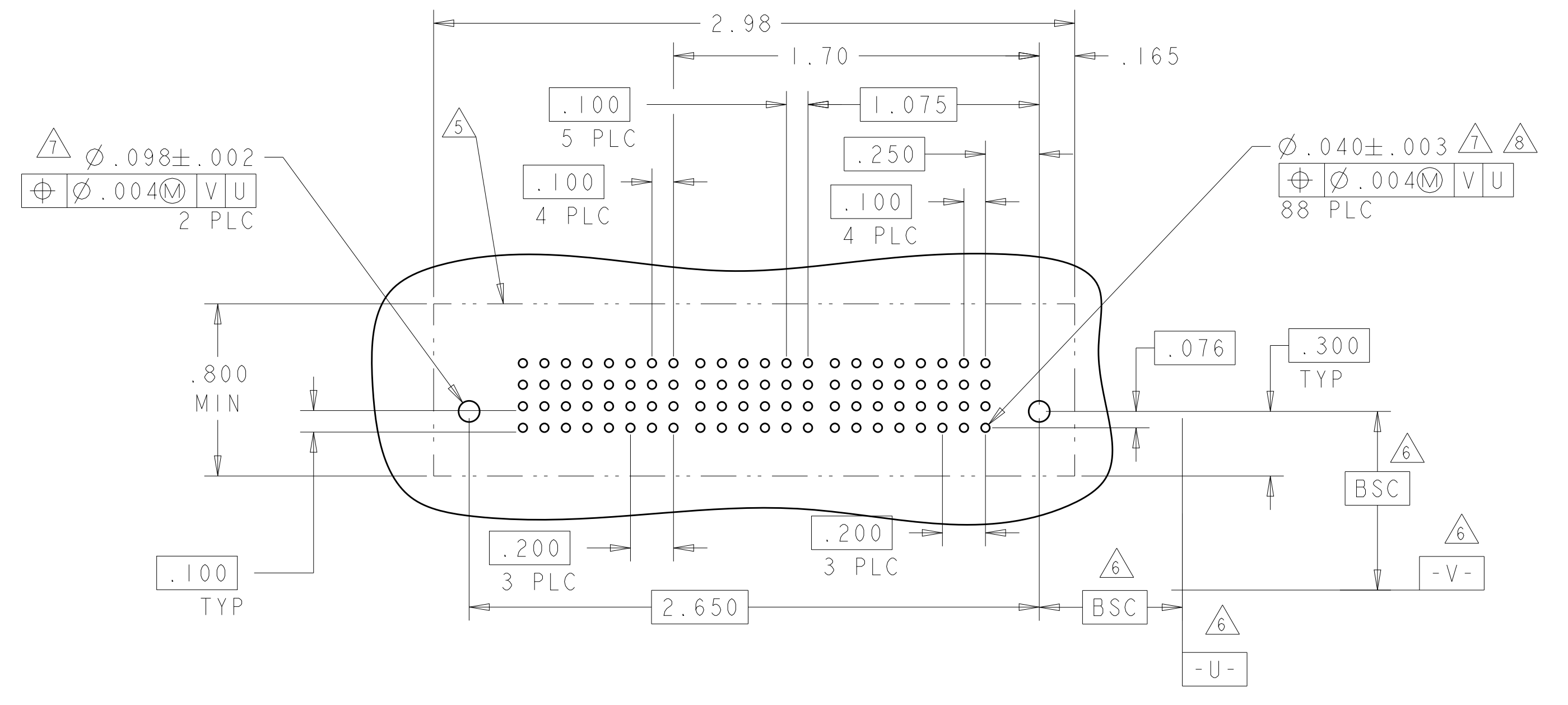

PART NUMBER	ROWS	POWER				SIGNAL				POWER			
		P4	P3	4	3	2	1	P2	P1	P2	P1	P2	P1
1-6450140-8	D C B A	VA	VA	E	E	E	E	VA	VA	VA	VA	VA	VA
2P + 16S + 2P													

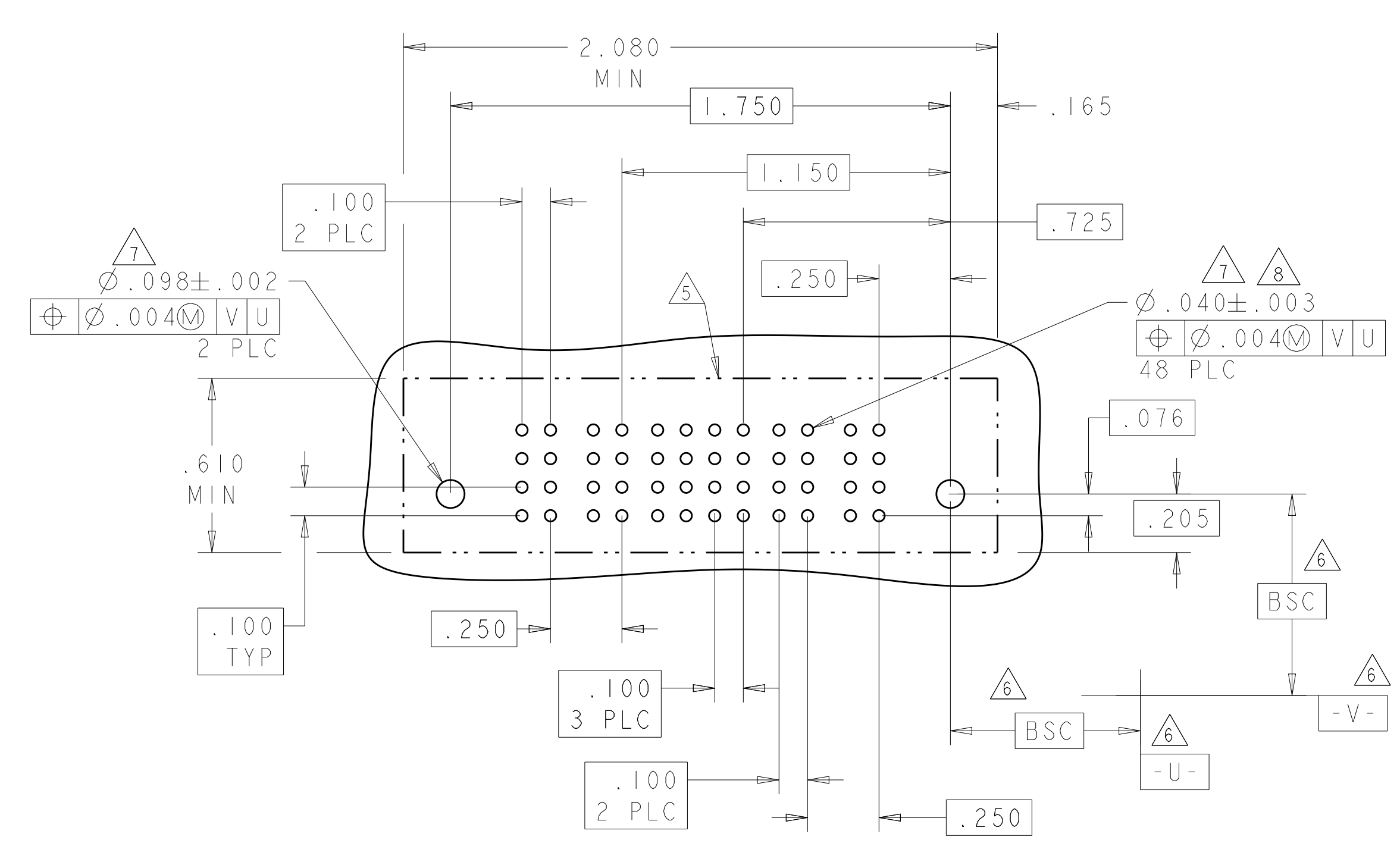

PART NUMBER	ROWS	POWER					SIGNAL					POWER				
		P4	P3	6	5	4	3	2	1	P2	P1	P2	P1	P2	P1	
2-6450140-0	D C B A	VA	VA	E	E	E	E	E	VA	VA	VA	VA	VA	VA		
2P + 24S + 2P																

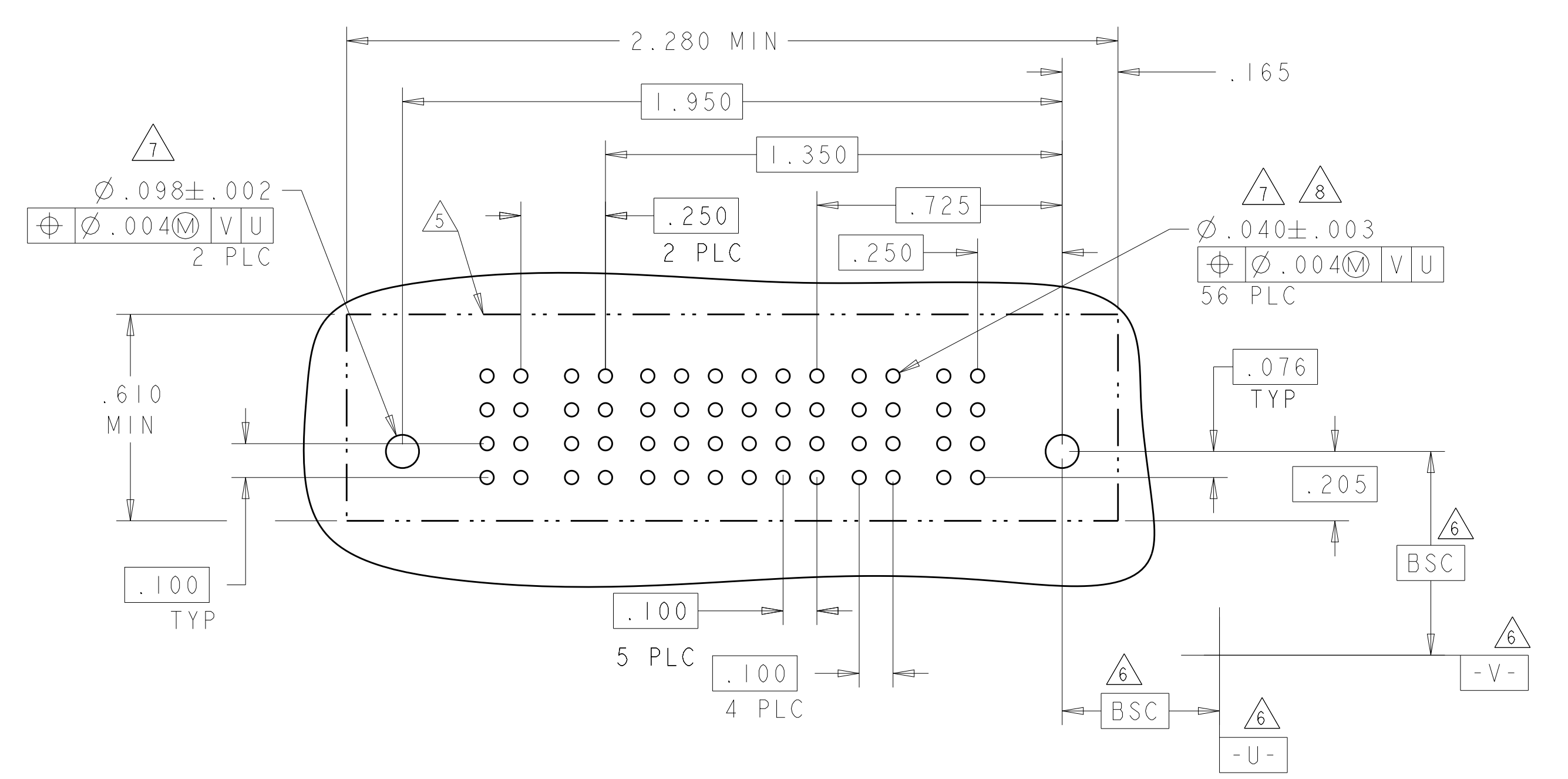

THIS DRAWING IS A CONTROLLED DOCUMENT. DIMENSIONS: INCHES. TOLERANCES UNLESS OTHERWISE SPECIFIED: 0 PLC ±.01, 1 PLC ±.01, 2 PLC ±.01, 3 PLC ±.005, 4 PLC ±.002, ANGLES ±.020. MATERIAL: FINISH: .

OWN: R. GRZYBOWSKI 15FEB05, CHK: M. PERCHERKE 15FEB05, APVD: M. PERCHERKE. PRODUCT SPEC: 108-1973, APPLICATION SPEC: 114-13038, WEIGHT: A100779, CAGE CODE: 6450140, DRAWING NO: 6450140, SHEET 7 OF 11, REV E4.

STE TE Connectivity
VERTICAL RECEPTACLE ASSEMBLY WITH GUIDES MULTI-BEAM XL

LOC	DIST	REV	DATE	BY	APPV
ES	00				

PART NUMBER	ROWS	POWER			SIGNAL						POWER		
		P6	P5	P4	6	5	4	3	2	1	P3	P2	P1
2-6450140-5	D C B A	VM	VM	VA	E	E	E	E	E	E	E	VM	VM
3P + 24S + 3P													

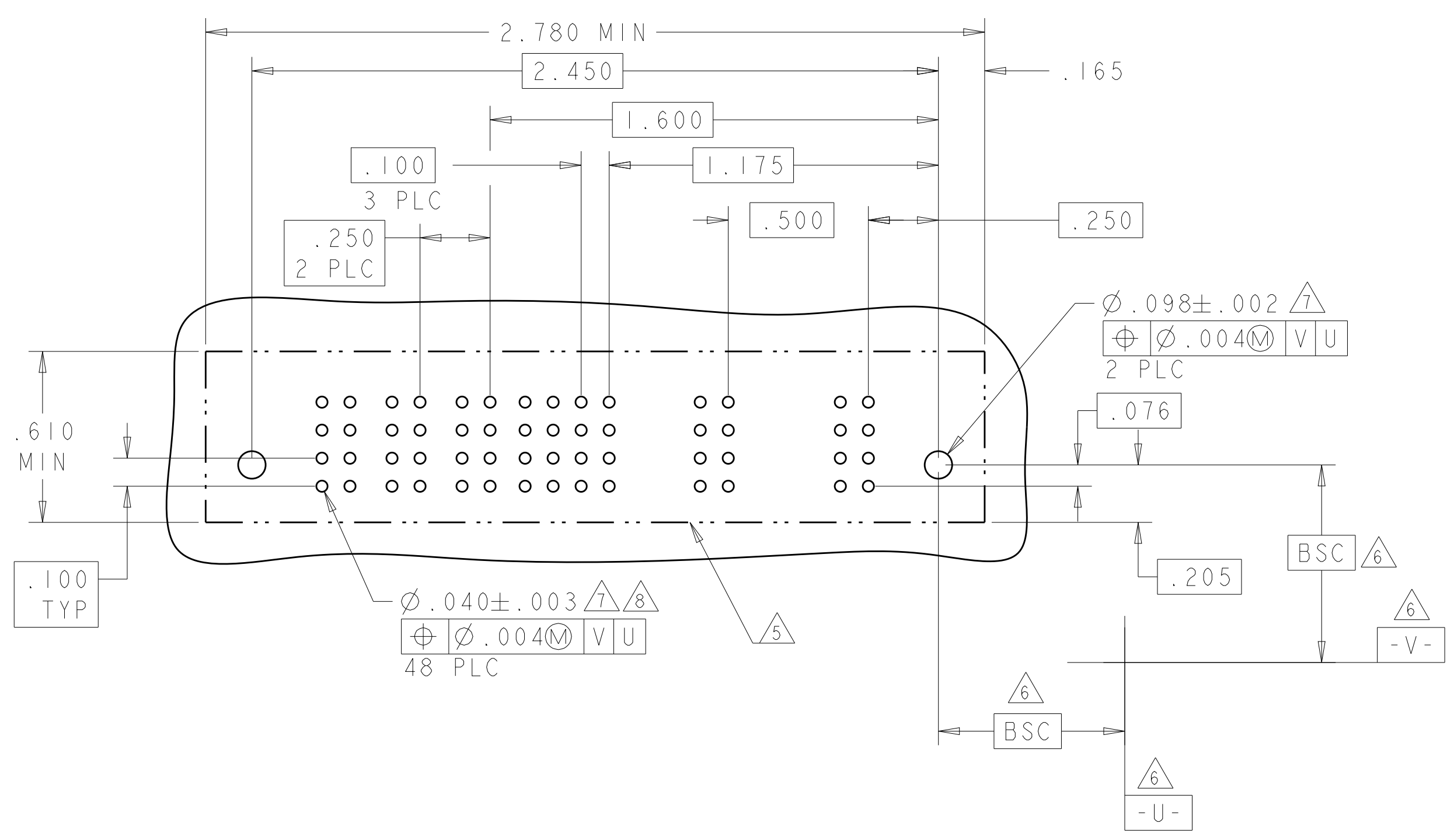

PART NUMBER	ROWS	POWER		SIGNAL						POWER					
		P6	P5	6	5	4	3	2	1	P4	P3	P2	P1		
2-6450140-7	D C B A	VM	VM	E	E	E	E	E	E	E	E	VM	VM	VM	VM
4P + 24S + 2P															

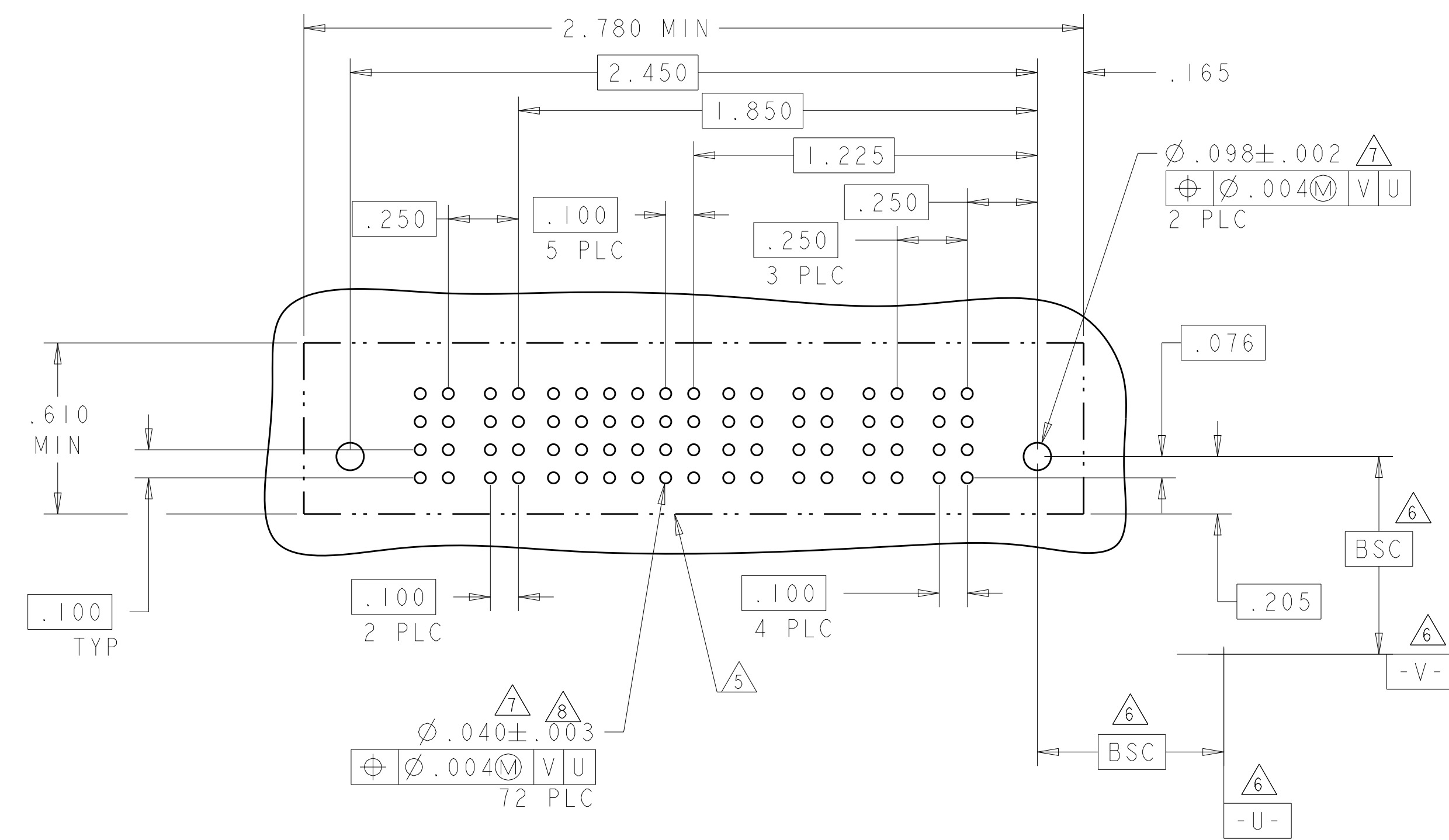

PART NUMBER	ROWS	POWER				SIGNAL						POWER													
		P12	P11	P10	P9	6	5	4	3	2	1	P8	P7	P6	P5	P4	P3	P2	P1						
2-6450140-6	D C B A	VM	VM	VM	VM	E	E	E	E	E	E	E	E	E	E	E	E	VM	VM	VM	VM	VM	VM	VM	VM
8P + 24S + 4ACP																									

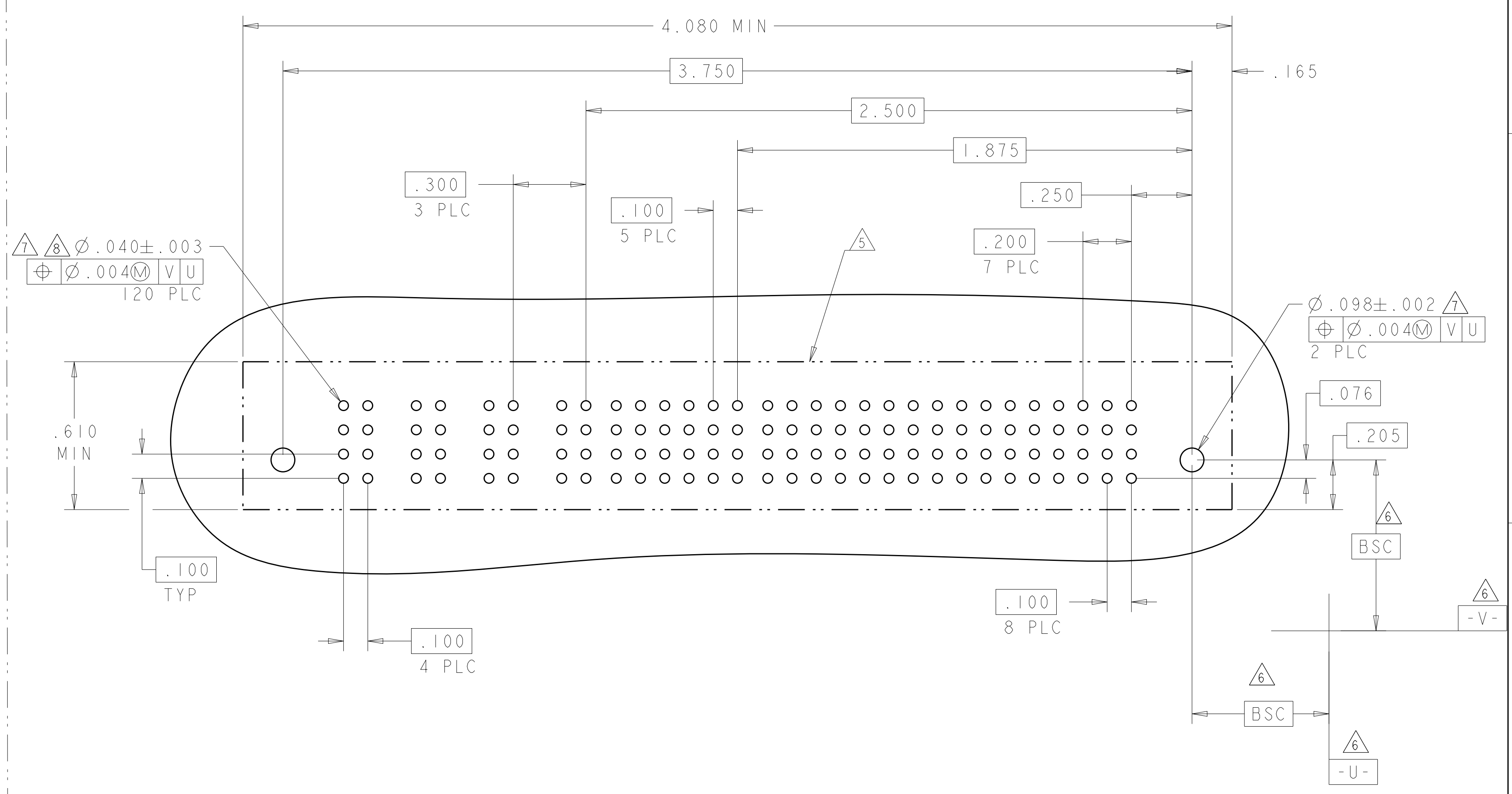

THIS DRAWING IS A CONTROLLED DOCUMENT. DWN: R. GRZYBOWSKI 15FEB05
 CHK: M. PERCHERKE 15FEB05

TE Connectivity

VERTICAL RECEPTACLE ASSEMBLY WITH GUIDES MULTI-BEAM XL

SCALE: 2:1 SHEET 8 OF 11 REV: E4

LOC	DIST	REVISIONS			
P	LTN	DESCRIPTION	DATE	DMN	APVD
ES	00	SEE SHEET 1			

PART NUMBER	ROWS	POWER				SIGNAL						POWER				
		P8	P7	P6	P5	6	5	4	3	2	1	P4	P3	P2	P1	
2-6450140-8	DCBA	VM	VM	VM	VM	E	E	E	E	E	E	E	E	E	E	E
		VM	VM	VM	VM	E	E	E	E	E	E	E	E	E	E	E
		VM	VM	VM	VM	E	E	E	E	E	E	E	E	E	E	E
		VM	VM	VM	VM	E	E	E	E	E	E	E	E	E	E	E
4P + 24S + 4P		HD														HD

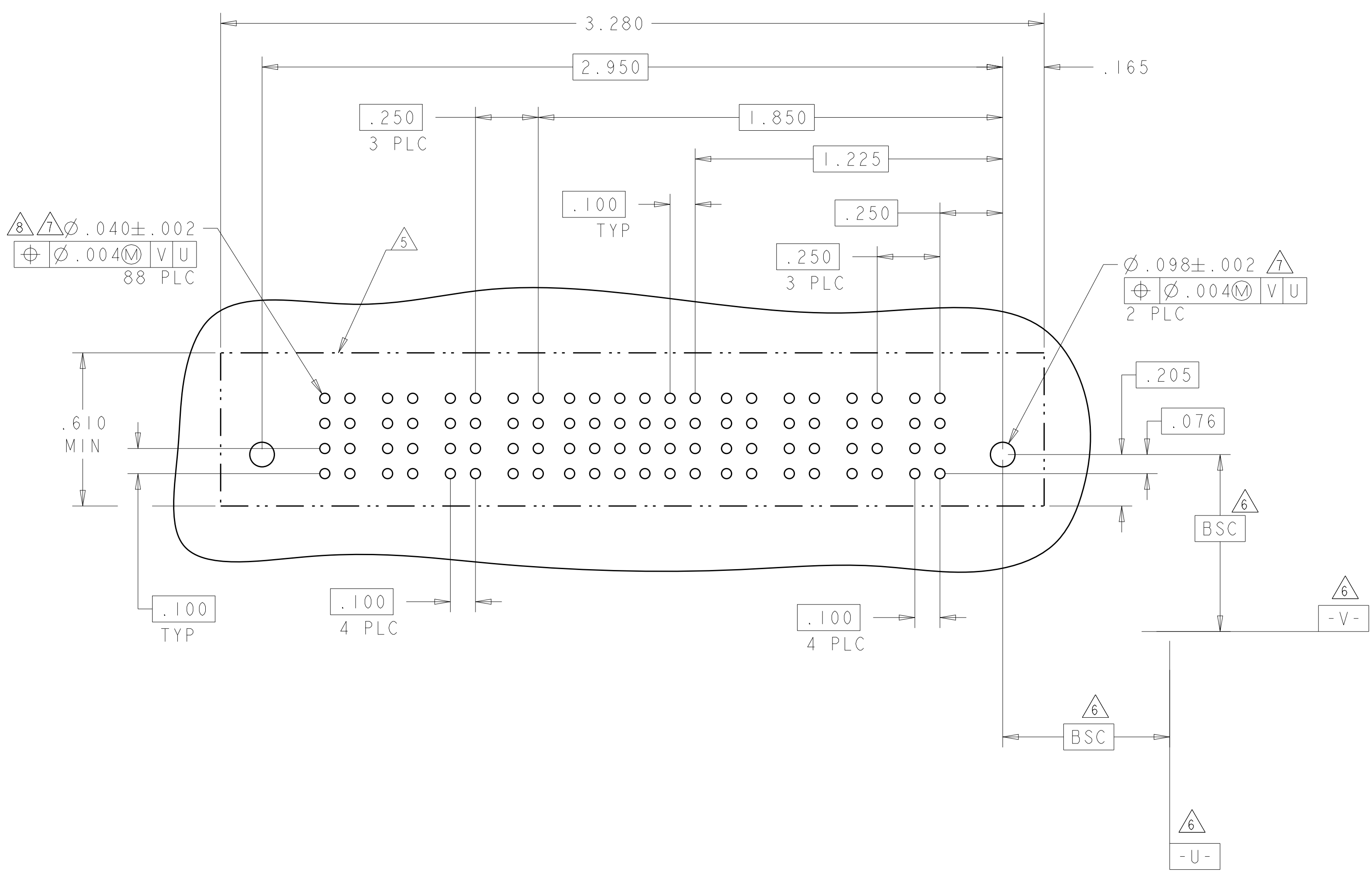

PART NUMBER	ROWS	POWER		SIGNAL						POWER		
		P2	P1	6	5	4	3	2	1	P4	P3	
3-6450140-5	DCBA	VA	VA	E	E	E	E	E	E	E	E	E
		VA	VA	E	E	E	E	E	E	E	E	E
		VA	VA	E	E	E	E	E	E	E	E	E
		VA	VA	E	E	E	E	E	E	E	E	E
IP + 24S + IP		HD										HD

PART NUMBER	ROWS	POWER		SIGNAL						POWER		
		P2	P1	6	5	4	3	2	1	P4	P3	
3-6450140-6	DCBA	VA	VA	E	E	E	E	E	E	E	E	E
		VA	VA	E	E	E	E	E	E	E	E	E
		VA	VA	E	E	E	E	E	E	E	E	E
		VA	VA	E	E	E	E	E	E	E	E	E
IP + 24S + IP		HD										HD

(E3)

NO CONTACTS LOADED

NO CONTACTS LOADED

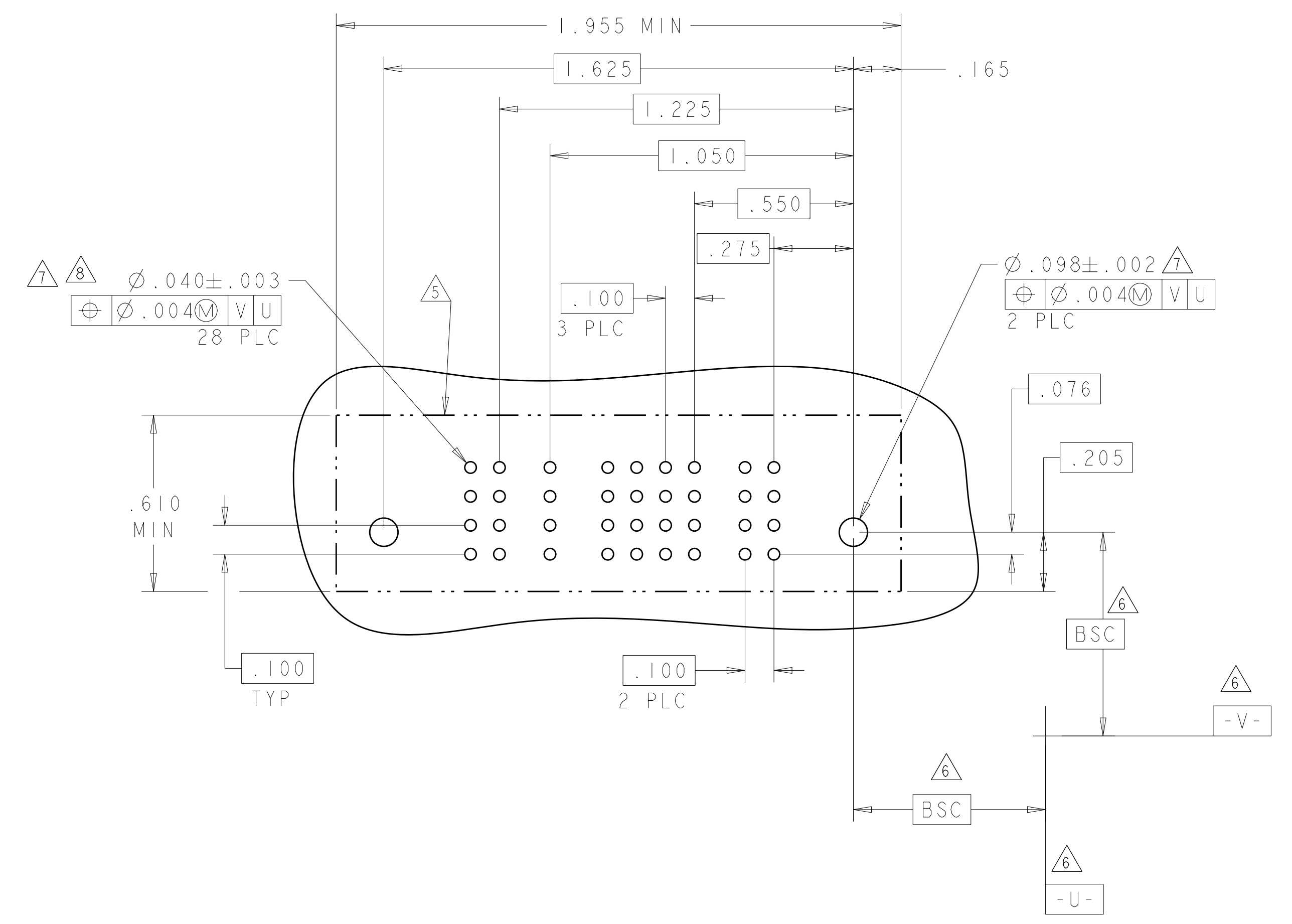

THIS DRAWING IS A CONTROLLED DOCUMENT.

DIMENSIONS:	TOLERANCES UNLESS OTHERWISE SPECIFIED:	DMN: R. GRZYBOWSKI 15FEB05	CHK: M. PERCHERKE 15FEB05	APVD: M. PERCHERKE	NAME: VERTICAL RECEPTACLE ASSEMBLY WITH GUIDES MULTI-BEAM XL
INCHES	0 PLC ± .01 1 PLC ± .01 2 PLC ± .01 3 PLC ± .005 4 PLC ± .002 ANGLES ± .020	PRODUCT SPEC: 108-1973	APPLICATION SPEC: 114-13038	WEIGHT: -	SIZE: A1
MATERIAL: -	FINISH: -	CAGE CODE: 6450140	DRAWING NO: 100779	SCALE: 2:1	SHEET 9 OF 11
CUSTOMER DRAWING		REV: E4			

4805 (3/11)

LOC	DIST	REVISIONS			
P	LTN	DESCRIPTION	DATE	DMN	APVD
ES	00	SEE SHEET 1	-	-	-

PART NUMBER	ROWS	POWER				SIGNAL		POWER			
		P8	P7	P6	P5	2	1	P4	P3	P2	P1
2-6450140-9	D C B A	VM	VM	VM	VM	E	E	VM	VM	VM	VM
						E	E				
						E	E				
						E	E				
4P + 8S + 4P		HD		HD							

PART NUMBER	ROWS	POWER						SIGNAL		POWER					
		P12	P11	P10	P9	P8	P7	2	1	P6	P5	P4	P3	P2	P1
3-6450140-0	D C B A	VM	VM	VM	VM	VM	VM	E	E	VM	VM	VM	VM	VM	
								E	E						
								E	E						
								E	E						
6P+8S+6P		HD		HD											

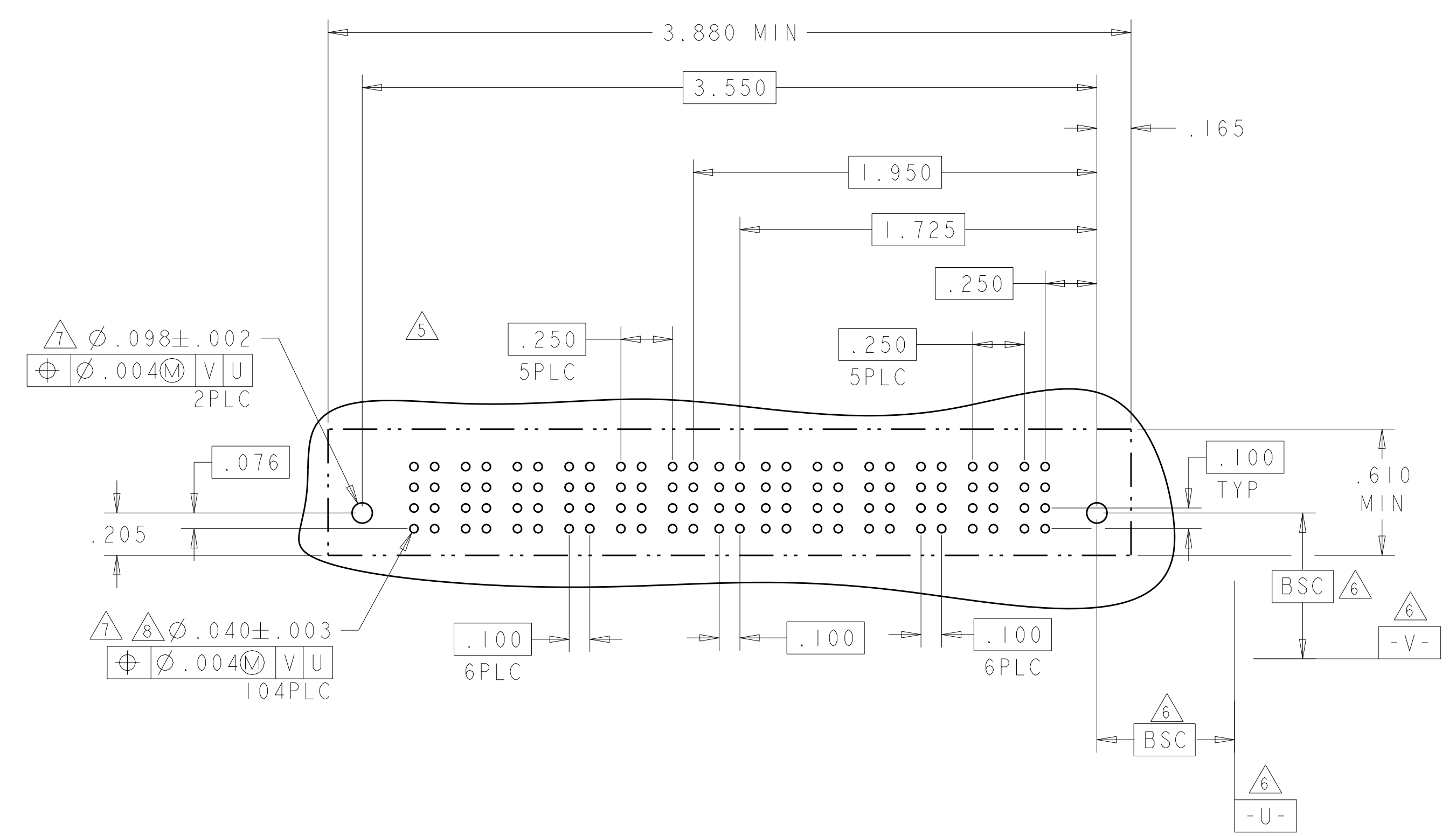
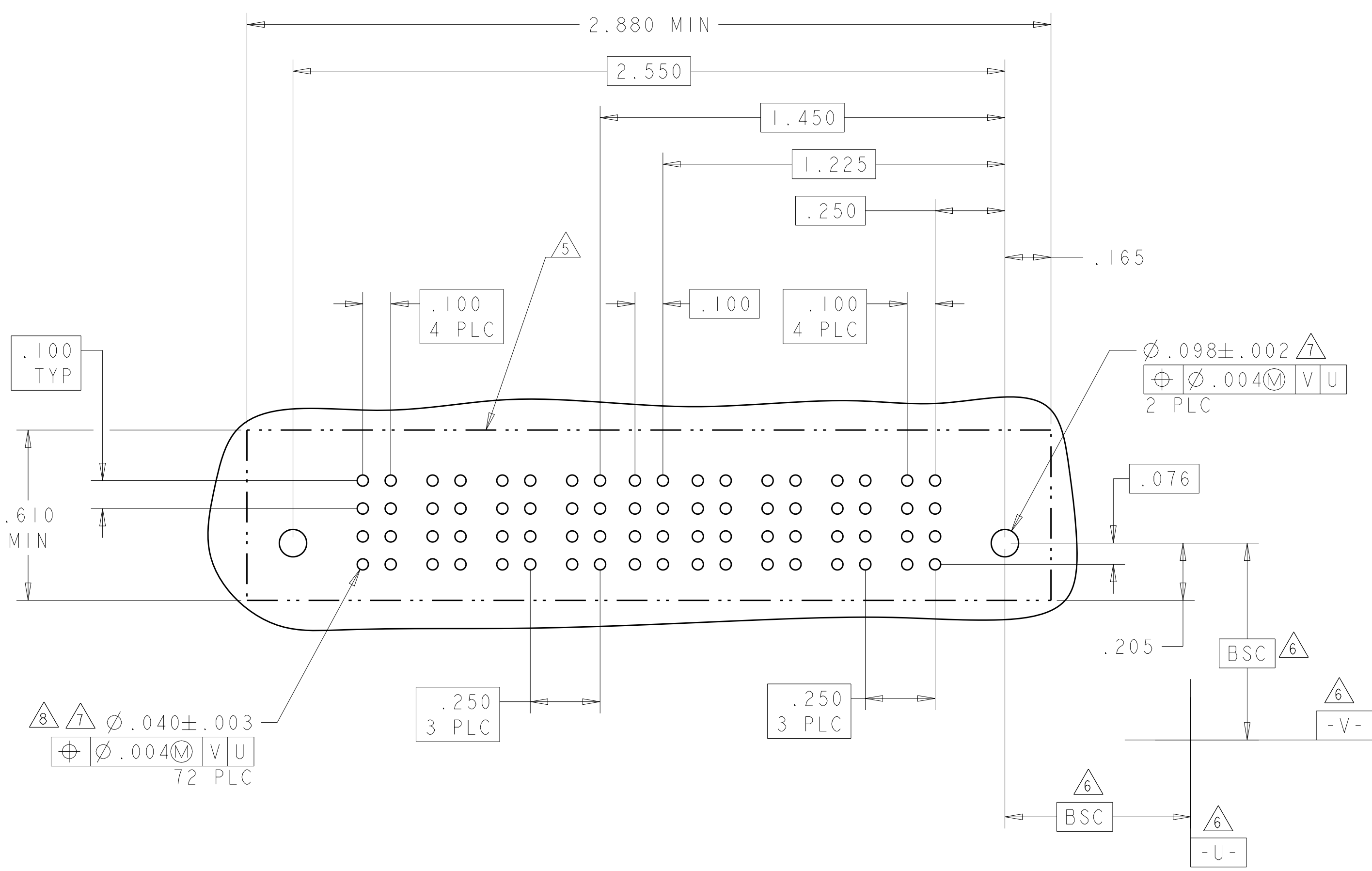

THIS DRAWING IS A CONTROLLED DOCUMENT.

DIMENSIONS: INCHES	TOLERANCES UNLESS OTHERWISE SPECIFIED: 0 PLC ±. 1 PLC ±.01 2 PLC ±.01 3 PLC ±.005 4 PLC ±.0020 ANGLES ±.7°	FINISH	FINISH
-----------------------	--	--------	--------

DMN: R. GRZYBOWSKI 15FEB05	CHK: M. PERCHERKE 15FEB05	APVD: M. PERCHERKE	NAME: VERTICAL RECEPTACLE ASSEMBLY WITH GUIDES MULTI-BEAM XL
PRODUCT SPEC: 108-1973	APPLICATION SPEC: 114-13038	WEIGHT: -	RESTRICTED TO: -
CUSTOMER DRAWING		SCALE: 2:1	SHEET 10 OF 11 REV E4

SIZE: A1 00779 C=6450140

LOC		DIST		REVISIONS			
ES	00	P	LTN	DESCRIPTION	DATE	DMN	APVD
		-		SEE SHEET 1			

PART NUMBER	ROWS	SIGNAL												P4	P3	P2	P1					
		P8	P7	P6	P5	9	8	7	6	5	4	3	2					1				
3-6450140-1	D	VM	VM	VM	VM	E	E	E	E	E	E	E	E	E	E	E	E	VM	VM	VM	VM	
	C					E	E	E	E	E	E	E	E	E	E	E	E					
	B					E	E	E	E	E	E	E	E	E	E	E	E					E
	A					E	E	E	E	E	E	E	E	E	E	E	E					E
4P + 36S + 4P		HD																				

PART NUMBER	ROWS	POWER			SIGNAL								POWER							
		P6	P5	P4	9	8	7	6	5	4	3	2	1	P3	P2	P1				
3-6450140-4	DCBA	VM	VM	VM	E	E	E	E	E	E	E	E	E	E	E	E	E	E		
					E	E	E	E	E	E	E	E	E	E	E	E	E	E	E	
					E	E	E	E	E	E	E	E	E	E	E	E	E	E	E	E
					E	E	E	E	E	E	E	E	E	E	E	E	E	E	E	E
3P + 36S + 3P		HD																		

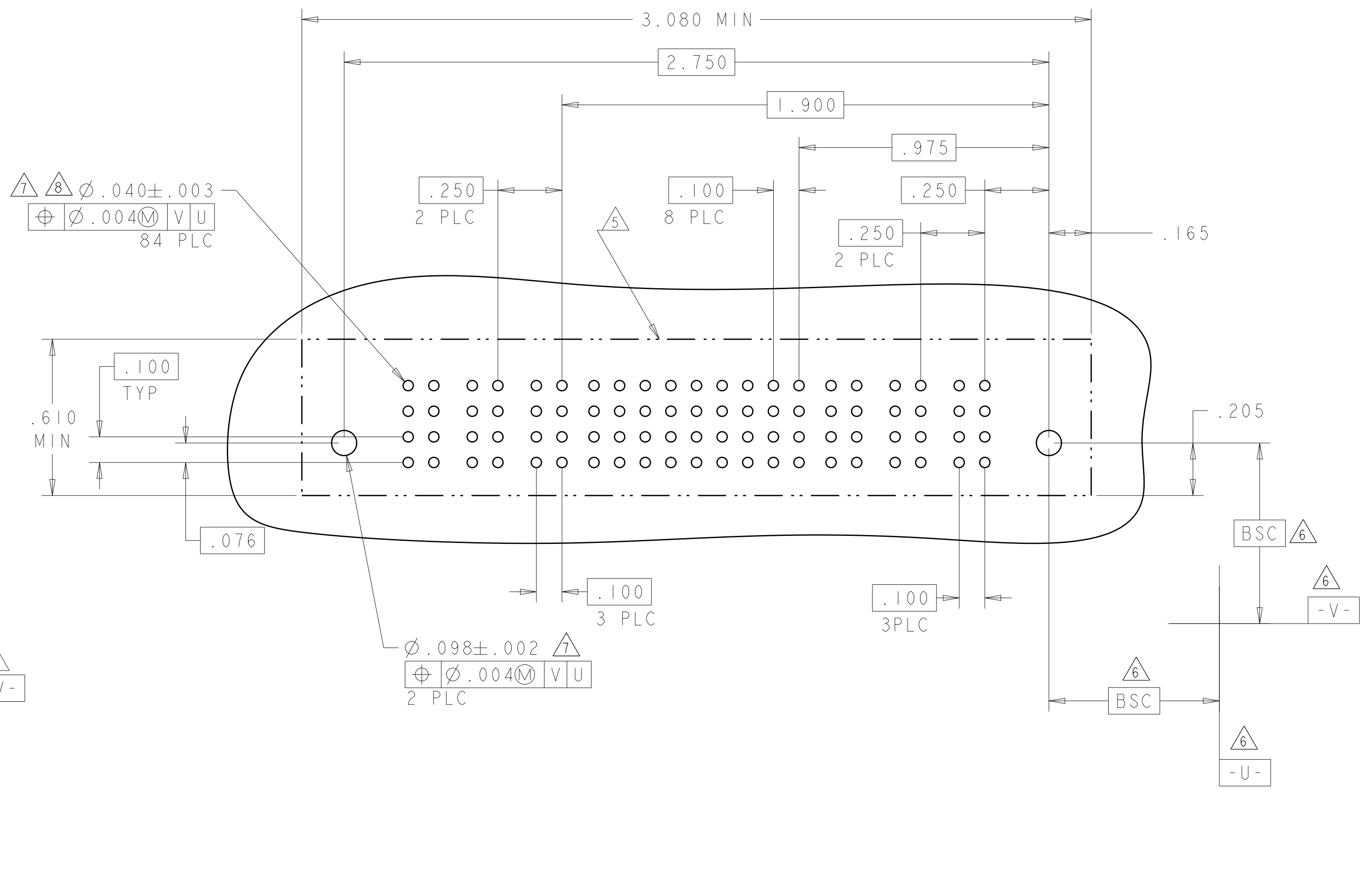
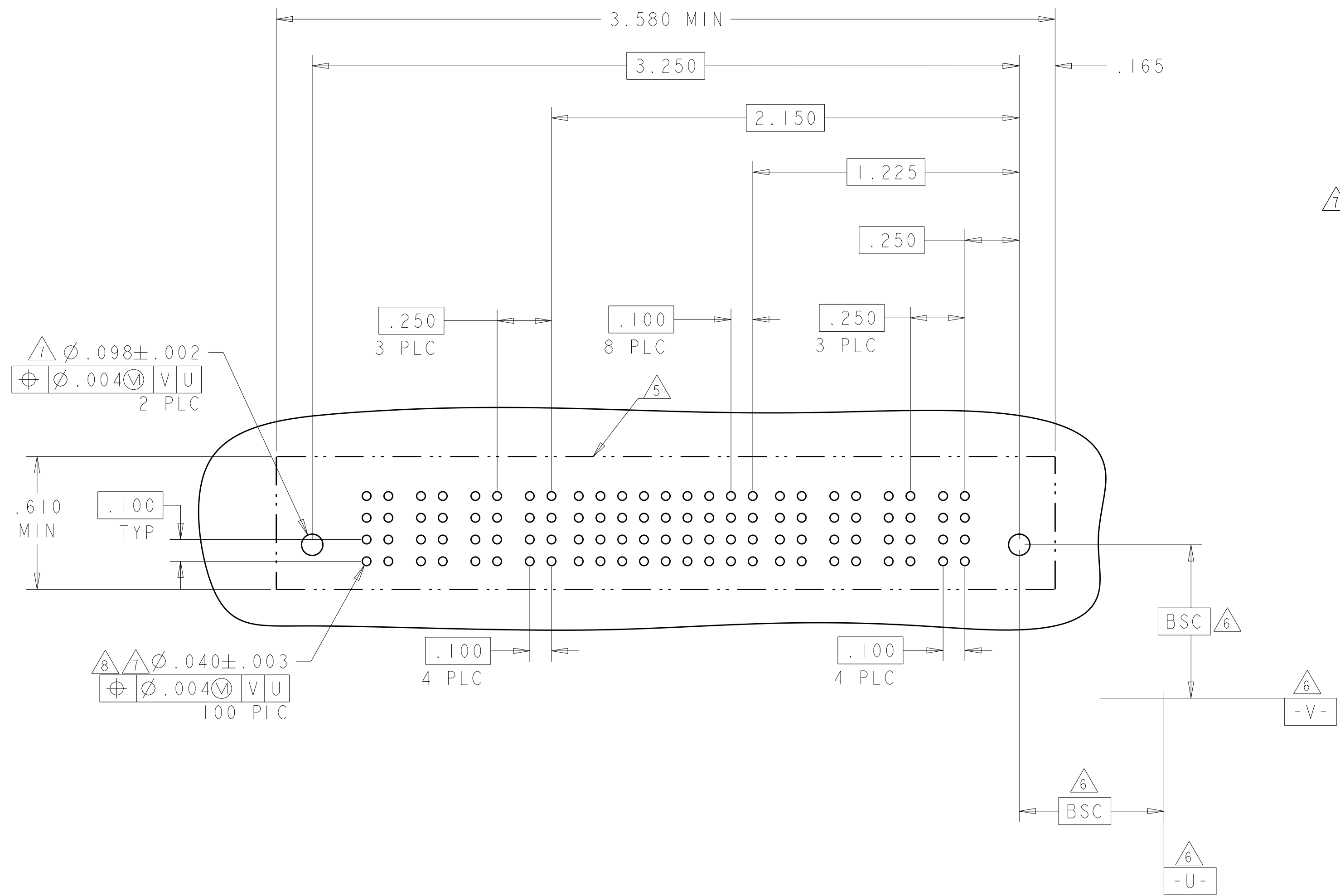

THIS DRAWING IS A CONTROLLED DOCUMENT.		DMN: R. GRZYBOWSKI 15FEB05	 TE Connectivity
DIMENSIONS: INCHES		CHK: M. PERCHERKE 15FEB05	
TOLERANCES UNLESS OTHERWISE SPECIFIED:		APVD: M. PERCHERKE	NAME: VERTICAL RECEPTACLE ASSEMBLY WITH GUIDES MULTI-BEAM XL
0 PLC ± .01 1 PLC ± .01 2 PLC ± .01 3 PLC ± .005 4 PLC ± .002 ANGLES ± .020		PRODUCT SPEC: 108-1973	SIZE: A1
MATERIAL: -		APPLICATION SPEC: 114-13038	CAGE CODE: 6450140
FINISH: -		WEIGHT: -	RESTRICTED TO: -
		CUSTOMER DRAWING	SCALE: 2:1 SHEET 11 OF 11 REV: E4

X-ON Electronics

Largest Supplier of Electrical and Electronic Components

Click to view similar products for [Power to the Board](#) category:

Click to view products by [TE Connectivity](#) manufacturer:

Other Similar products are found below :

[10131318-08512GRLF](#) [6450171-4](#) [6450552-7](#) [6600323-8](#) [6643429-1](#) [6646040-2](#) [6651939-1](#) [6766604-1](#) [120959-1](#) [1393557-2](#) [1393532-2](#)
[1393532-3](#) [1393532-4](#) [1393557-1](#) [1600812-5](#) [1-6450861-2](#) [1645595-1](#) [1743490-1](#) [1744132-7](#) [1761122-1](#) [1766169-1](#) [1766250-1](#) [18362](#)
[1892109-1](#) [1-967627-6](#) [2226808-1](#) [2-6450860-5](#) [2-6450860-6](#) [2-6450870-0](#) [93003-0502](#) [953552-1](#) [1-6450161-4](#) [1-6450850-6](#) [1645526-2](#) [1-](#)
[6600130-0](#) [1743419-1](#) [1766150-1](#) [2005243-2](#) [211110-1](#) [2-6600130-2](#) [TE34-12-16P-F0](#) [5-6450830-6](#) [5646956-4](#) [36662-0005](#) [40585-3000](#) [4-](#)
[6450830-9](#) [4-6600333-3](#) [51142-0214](#) [10134048-911LF](#) [10123159-301LF](#)