

## Current Transducer HLSR-P series

$I_{PN} = 10 \dots 50 \text{ A}$

Ref: HLSR 10-P, HLSR 16-P, HLSR 20-P, HLSR 32-P, HLSR 40-P, HLSR 50-P

For the electronic measurement of current: DC, AC, pulsed..., with galvanic separation between the primary and the secondary circuit.

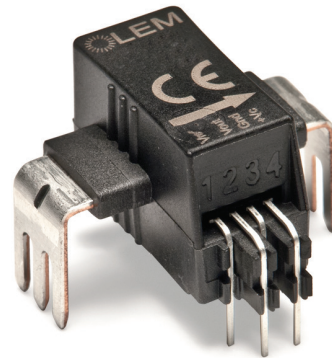

### Features

- Open loop multi-range current transducer
- Voltage output
- Single supply +5 V
- Galvanic separation between primary and secondary
- Low power consumption
- Compact design for through-hole PCB mounting
- Factory calibrated
- High bandwidth, very low loss magnetic core.

### Advantages

- Extremely low profile:  $h = 12 \text{ mm}$
- Low foot-print
- Low offset drift
- Over-drivable  $V_{ref}$

### Applications

- AC variable speed and servo motor drives
- Static converters for DC motor drives
- Battery supplied applications
- Uninterruptible Power Supplies (UPS)
- Switched Mode Power Supplies (SMPS)
- Power supplies for welding applications
- Combiner box
- MPPT.

### Standards

- EN 50178: 1997
- IEC 61010-1: 2010
- IEC 61326-1: 2012
- UL 508: 2010.

### Application Domain

- Industrial.

## Absolute maximum ratings

Parameter	Symbol	Unit	Value
Supply voltage (not destructive)	$U_C$	V	8
Supply voltage (not entering non standard modes)	$U_C$	V	6.5
Primary conductor temperature	$T_B$	°C	120
ESD rating, Human Body Model (HBM)	$U_{ESD}$	kV	2

Stresses above these ratings may cause permanent damage. Exposure to absolute maximum ratings for extended periods may degrade reliability.

## UL 508: Ratings and assumptions of certification

File # E189713 Volume: 2 Section: 5

### Standards

- CSA C22.2 NO. 14-10 INDUSTRIAL CONTROL EQUIPMENT - Edition 11 - Revision Date 2011/08/01
- UL 508 STANDARD FOR INDUSTRIAL CONTROL EQUIPMENT - Edition 17 - Revision Date 2010/04/15

### Ratings

Parameter	Symbol	Unit	Value
Primary involved potential		V AC/DC	600
Max surrounding air temperature	$T_A$	°C	105
Primary current	$I_P$	A	According to series primary current
Secondary supply voltage	$U_C$	V DC	5
Output voltage	$V_{out}$	V	0 to 5

### Conditions of acceptability

- 1 - These devices have been evaluated for overvoltage category III and for use in pollution degree 2 environment.
- 2 - A suitable enclosure shall be provided in the end-use application.
- 3 - The terminals have not been evaluated for field wiring.
- 4 - These devices are intended to be mounted on a printed wiring board of end use equipment. The suitability of the connections (including spacings) shall be determined in the end-use application.
- 5 - Primary terminals shall not be straightened since assembly of housing case depends upon bending of the terminals.
- 6 - Any surface of polymeric housing have not been evaluated as insulating barrier.
- 7 - Low voltage control circuit shall be supplied by an isolating source (such as a transformer, optical isolator, limiting impedance or electro-mechanical relay).

### Marking

Only those products bearing the UR Mark should be considered to be Listed or Recognized and covered under UL's Follow-Up Service. Always look for the Mark on the product.

**Insulation coordination**

Parameter	Symbol	Unit	Value	Comment
Rms voltage for AC insulation test 50/60 Hz/1 min	$U_d$	kV	4.3	
Impulse withstand voltage 1.2/50 $\mu$ s	$\hat{U}_w$	kV	8	
Clearance (pri. - sec.)	$d_{Cl}$	mm	> 8	Shortest distance through air
Creepage distance (pri. - sec.)	$d_{Cp}$	mm	> 8	Shortest path along device body
Clearance (pri. - sec.)	-	mm	8	When mounted on PCB with recommended layout
Case material	-	-	V0	According to UL 94
Comparative tracking index	<i>CTI</i>		600	
Application example	-	-	600 V CAT III PD2	Reinforced insulation, non uniform field according to EN 50178, IEC 61010
Application example	-	-	1000 V CAT III PD2	Simple insulation, non uniform field according to EN 50178, IEC 61010
Application example	-	-	600 V CAT III PD2	According to UL 508

**Environmental and mechanical characteristics**

Parameter	Symbol	Unit	Min	Typ	Max	Comment
Ambient operating temperature	$T_A$	$^{\circ}$ C	-40		105	
Ambient storage temperature	$T_S$	$^{\circ}$ C	-40		105	
Mass	$m$	g			5	

**Electrical data HLSR 10-P**

 At  $T_A = 25\text{ °C}$ ,  $U_C = +5\text{ V}$ ,  $R_L = 10\text{ k}\Omega$  unless otherwise noted (see Min, Max, typ. definition paragraph in page 10).

Parameter	Symbol	Unit	Min	Typ	Max	Comment
Primary nominal rms current	$I_{PN}$	A		10		
Primary current, measuring range	$I_{PM}$	A	-25		25	For $U_C > 4.6\text{ V}$
Number of primary turns	$N_p$	-		1		
Resistance of primary jumper @ $T_A = 25\text{ °C}$	$R_p$	m $\Omega$		0.21		
Resistance of primary jumper @ $T_A = 105\text{ °C}$	$R_p$	m $\Omega$		0.29		T jumper = 120 °C
Supply voltage <sup>1)</sup>	$U_C$	V	4.5	5	5.5	
Current consumption	$I_C$	mA		19	25	
Reference voltage (output)	$V_{ref}$	V	2.48	2.5	2.52	Internal reference
Reference voltage (input)	$V_{ref}$	V	0.5		2.65	External reference
Output voltage range @ $I_{PM}$	$V_{out} - V_{ref}$	V	-2		2	Over operating temperature range
$V_{ref}$ output resistance	$R_{ref}$	$\Omega$	130	200	300	series
$V_{out}$ output resistance	$R_{out}$	$\Omega$		2	5	series
Capacitive loading	$C_L$	nF	0		6	
Electrical offset voltage @ $I_p = 0$	$V_{OE}$	mV	-5		5	$V_{out} - V_{ref}$ @ $V_{ref} = 2.5\text{ V}$
Electrical offset current referred to primary	$I_{OE}$	mA	-62.5		62.5	
Temperature coefficient of $V_{ref}$	$TCV_{ref}$	ppm/K	-170		170	-40 °C ... 105 °C
Temperature coefficient of $V_{OE}$	$TCV_{OE}$	mV/K	-0.075		0.075	-40 °C ... 105 °C
Temperature coefficient of $I_{OE}$	$TCI_{OE}$	mA/K	-0.94		0.94	-40 °C ... 105 °C
Theoretical sensitivity	$G_{th}$	mV/A		80		800 mV @ $I_{PN}$
Sensitivity error	$\epsilon_G$	%	-0.5		0.5	Factory adjustment
Temperature coefficient of G	$TCG$	ppm/K	-200		200	-40 °C ... 105 °C
Linearity error 0 ... $I_{PN}$	$\epsilon_L$	% of $I_{PN}$	-0.5		0.5	
Linearity error 0 ... $I_{PM}$	$\epsilon_L$	% of $I_{PM}$	-0.5		0.5	
Magnetic offset current (@ $10 \times I_{PN}$ ) referred to primary	$I_{OM}$	A	-0.25		0.25	
Reaction time @ 10 % of $I_{PN}$	$t_{ra}$	$\mu\text{s}$			2	@ 50 A/ $\mu\text{s}$
Response time @ 90 % of $I_{PN}$	$t_r$	$\mu\text{s}$			2.5	@ 50 A/ $\mu\text{s}$
Frequency bandwidth (-3 dB)	$BW$	kHz		400		
Output rms voltage noise spectral density 100 Hz ... 100 kHz	$e_{no}$	$\mu\text{V}/\sqrt{\text{Hz}}$			28	
Output voltage noise DC ... 10 kHz DC ... 100 kHz DC ... 1 MHz	$V_{no}$	mVpp		17.5 46.1 65.7		
Accuracy @ $I_{PN}$	$X$	% of $I_{PN}$	-1		1	
Accuracy @ $I_{PN}$ @ $T_A = +85\text{ °C}$	$X_{85\text{ °C}}$	% of $I_{PN}$	-2.9		2.9	See formula note <sup>2)</sup>
Accuracy @ $I_{PN}$ @ $T_A = +105\text{ °C}$	$X_{105\text{ °C}}$	% of $I_{PN}$	-3.4		3.4	See formula note <sup>2)</sup>

 Notes: <sup>1)</sup> 3.3 V SP version available

$$^2) \text{ Accuracy @ } T_A (\% \text{ of } I_{PN}) = X + \left( \frac{TCG}{10000} \times (T_A - 25) \right) + \left( \frac{TCI_{OE}}{1000 \times I_p} \times 100 \times (T_A - 25) \right).$$

**Electrical data HLSR 16-P**

 At  $T_A = 25\text{ °C}$ ,  $U_C = +5\text{ V}$ ,  $R_L = 10\text{ k}\Omega$  unless otherwise noted (see Min, Max, typ. definition paragraph in page 10).

Parameter	Symbol	Unit	Min	Typ	Max	Comment
Primary nominal rms current	$I_{PN}$	A		16		
Primary current, measuring range	$I_{PM}$	A	-40		40	For $U_C > 4.6\text{ V}$
Number of primary turns	$N_P$	-		1		
Resistance of primary jumper @ $T_A = 25\text{ °C}$	$R_P$	m $\Omega$		0.21		
Resistance of primary jumper @ $T_A = 105\text{ °C}$	$R_P$	m $\Omega$		0.29		T jumper = 120 °C
Supply voltage <sup>1)</sup>	$U_C$	V	4.5	5	5.5	
Current consumption	$I_C$	mA		19	25	
Reference voltage (output)	$V_{ref}$	V	2.48	2.5	2.52	Internal reference
Reference voltage (input)	$V_{ref}$	V	0.5		2.65	External reference
Output voltage range @ $I_{PM}$	$V_{out} - V_{ref}$	V	-2		2	Over operating temperature range
$V_{ref}$ output resistance	$R_{ref}$	$\Omega$	130	200	300	series
$V_{out}$ output resistance	$R_{out}$	$\Omega$		2	5	series
Capacitive loading	$C_L$	nF	0		6	
Electrical offset voltage @ $I_p = 0$	$V_{OE}$	mV	-5		5	$V_{out} - V_{ref}$ @ $V_{ref} = 2.5\text{ V}$
Electrical offset current referred to primary	$I_{OE}$	mA	-100		100	
Temperature coefficient of $V_{ref}$	$TCV_{ref}$	ppm/K	-170		170	-40 °C ... 105 °C
Temperature coefficient of $V_{OE}$	$TCV_{OE}$	mV/K	-0.075		0.075	-40 °C ... 105 °C
Temperature coefficient of $I_{OE}$	$TCI_{OE}$	mA/K	-1.5		1.5	-40 °C ... 105 °C
Theoretical sensitivity	$G_{th}$	mV/A		50		800 mV @ $I_{PN}$
Sensitivity error	$\epsilon_G$	%	-0.5		0.5	Factory adjustment
Temperature coefficient of G	$TCG$	ppm/K	-200		200	-40 °C ... 105 °C
Linearity error 0 ... $I_{PN}$	$\epsilon_L$	% of $I_{PN}$	-0.5		0.5	
Linearity error 0 ... $I_{PM}$	$\epsilon_L$	% of $I_{PM}$	-0.5		0.5	
Magnetic offset current (@ $10 \times I_{PN}$ ) referred to primary	$I_{OM}$	A	-0.25		0.25	
Reaction time @ 10 % of $I_{PN}$	$t_{ra}$	$\mu\text{s}$			2	@ 50 A/ $\mu\text{s}$
Response time @ 90 % of $I_{PN}$	$t_r$	$\mu\text{s}$			2.5	@ 50 A/ $\mu\text{s}$
Frequency bandwidth (-3 dB)	$BW$	kHz		400		
Output rms voltage noise spectral density 100 Hz ... 100 kHz	$e_{no}$	$\mu\text{V}/\sqrt{\text{Hz}}$			28	
Output voltage noise DC ... 10 kHz DC ... 100 kHz DC ... 1 MHz	$V_{no}$	mVpp		11.3 28.6 41.2		
Accuracy @ $I_{PN}$	$X$	% of $I_{PN}$	-1		1	
Accuracy @ $I_{PN}$ @ $T_A = +85\text{ °C}$	$X_{85\text{ °C}}$	% of $I_{PN}$	-2.9		2.9	See formula note <sup>2)</sup>
Accuracy @ $I_{PN}$ @ $T_A = +105\text{ °C}$	$X_{105\text{ °C}}$	% of $I_{PN}$	-3.4		3.4	See formula note <sup>2)</sup>

 Notes: <sup>1)</sup> 3.3 V SP version available

$$^2) \text{Accuracy @ } T_A (\% \text{ of } I_{PN}) = X + \left( \frac{TCG}{10000} \times (T_A - 25) \right) + \left( \frac{TCI_{OE}}{1000 \times I_P} \times 100 \times (T_A - 25) \right).$$

**Electrical data HLSR 20-P**

 At  $T_A = 25\text{ °C}$ ,  $U_C = +5\text{ V}$ ,  $R_L = 10\text{ k}\Omega$  unless otherwise noted (see Min, Max, typ. definition paragraph in page 10).

Parameter	Symbol	Unit	Min	Typ	Max	Comment
Primary nominal rms current	$I_{PN}$	A		20		
Primary current, measuring range	$I_{PM}$	A	-50		50	For $U_C > 4.6\text{ V}$
Number of primary turns	$N_P$	-		1		
Resistance of primary jumper @ $T_A = 25\text{ °C}$	$R_P$	m $\Omega$		0.21		
Resistance of primary jumper @ $T_A = 105\text{ °C}$	$R_P$	m $\Omega$		0.29		T jumper = 120 °C
Supply voltage <sup>1)</sup>	$U_C$	V	4.5	5	5.5	
Current consumption	$I_C$	mA		19	25	
Reference voltage (output)	$V_{ref}$	V	2.48	2.5	2.52	Internal reference
Reference voltage (input)	$V_{ref}$	V	0.5		2.65	External reference
Output voltage range @ $I_{PM}$	$V_{out} - V_{ref}$	V	-2		2	Over operating temperature range
$V_{ref}$ output resistance	$R_{ref}$	$\Omega$	130	200	300	series
$V_{out}$ output resistance	$R_{out}$	$\Omega$		2	5	series
Capacitive loading	$C_L$	nF	0		6	
Electrical offset voltage @ $I_P = 0$	$V_{OE}$	mV	-5		5	$V_{out} - V_{ref}$ @ $V_{ref} = 2.5\text{ V}$
Electrical offset current referred to primary	$I_{OE}$	mA	-125		125	
Temperature coefficient of $V_{ref}$	$TCV_{ref}$	ppm/K	-170		170	-40 °C ... 105 °C
Temperature coefficient of $V_{OE}$	$TCV_{OE}$	mV/K	-0.075		0.075	-40 °C ... 105 °C
Temperature coefficient of $I_{OE}$	$TCI_{OE}$	mA/K	-1.88		1.88	-40 °C ... 105 °C
Theoretical sensitivity	$G_{th}$	mV/A		40		800 mV @ $I_{PN}$
Sensitivity error	$\epsilon_G$	%	-0.5		0.5	Factory adjustment
Temperature coefficient of G	$TCG$	ppm/K	-200		200	-40 °C ... 105 °C
Linearity error 0 ... $I_{PN}$	$\epsilon_L$	% of $I_{PN}$	-0.5		0.5	
Linearity error 0 ... $I_{PM}$	$\epsilon_L$	% of $I_{PM}$	-0.5		0.5	
Magnetic offset current (@ $10 \times I_{PN}$ ) referred to primary	$I_{OM}$	A	-0.25		0.25	
Reaction time @ 10 % of $I_{PN}$	$t_{ra}$	$\mu\text{s}$			2	@ 50 A/ $\mu\text{s}$
Response time @ 90 % of $I_{PN}$	$t_r$	$\mu\text{s}$			2.5	@ 50 A/ $\mu\text{s}$
Frequency bandwidth (-3 dB)	$BW$	kHz		400		
Output rms voltage noise spectral density 100 Hz ... 100 kHz	$e_{no}$	$\mu\text{V}/\sqrt{\text{Hz}}$			14	
Output voltage noise DC ... 10 kHz DC ... 100 kHz DC ... 1 MHz	$V_{no}$	mVpp		9.2 22.8 33		
Accuracy @ $I_{PN}$	$X$	% of $I_{PN}$	-1		1	
Accuracy @ $I_{PN}$ @ $T_A = +85\text{ °C}$	$X_{85\text{ °C}}$	% of $I_{PN}$	-2.9		2.9	See formula note <sup>2)</sup>
Accuracy @ $I_{PN}$ @ $T_A = +105\text{ °C}$	$X_{105\text{ °C}}$	% of $I_{PN}$	-3.4		3.4	See formula note <sup>2)</sup>

 Notes: <sup>1)</sup> 3.3 V SP version available

$$^2) \text{ Accuracy @ } T_A (\% \text{ of } I_{PN}) = X + \left( \frac{TCG}{10000} \times (T_A - 25) \right) + \left( \frac{TCI_{OE}}{1000 \times I_P} \times 100 \times (T_A - 25) \right).$$

**Electrical data HLSR 32-P**

 At  $T_A = 25\text{ °C}$ ,  $U_C = +5\text{ V}$ ,  $R_L = 10\text{ k}\Omega$  unless otherwise noted (see Min, Max, typ. definition paragraph in page 10).

Parameter	Symbol	Unit	Min	Typ	Max	Comment
Primary nominal rms current	$I_{PN}$	A		32		
Primary current, measuring range	$I_{PM}$	A	-80		80	For $U_C > 4.6\text{ V}$
Number of primary turns	$N_P$	-		1		
Resistance of primary jumper @ $T_A = 25\text{ °C}$	$R_P$	m $\Omega$		0.21		
Resistance of primary jumper @ $T_A = 105\text{ °C}$	$R_P$	m $\Omega$		0.29		T jumper = 120 °C
Supply voltage <sup>1)</sup>	$U_C$	V	4.5	5	5.5	
Current consumption	$I_C$	mA		19	25	
Reference voltage (output)	$V_{ref}$	V	2.48	2.5	2.52	Internal reference
Reference voltage (input)	$V_{ref}$	V	0.5		2.65	External reference
Output voltage range @ $I_{PM}$	$V_{out} - V_{ref}$	V	-2		2	Over operating temperature range
$V_{ref}$ output resistance	$R_{ref}$	$\Omega$	130	200	300	series
$V_{out}$ output resistance	$R_{out}$	$\Omega$		2	5	series
Capacitive loading	$C_L$	nF	0		6	
Electrical offset voltage @ $I_P = 0$	$V_{OE}$	mV	-5		5	$V_{out} - V_{ref}$ @ $V_{ref} = 2.5\text{ V}$
Electrical offset current referred to primary	$I_{OE}$	mA	-200		200	
Temperature coefficient of $V_{ref}$	$TCV_{ref}$	ppm/K	-170		170	-40 °C ... 105 °C
Temperature coefficient of $V_{OE}$	$TCV_{OE}$	mV/K	-0.075		0.075	-40 °C ... 105 °C
Temperature coefficient of $I_{OE}$	$TCI_{OE}$	mA/K	-3		3	-40 °C ... 105 °C
Theoretical sensitivity	$G_{th}$	mV/A		25		800 mV @ $I_{PN}$
Sensitivity error	$\epsilon_G$	%	-0.5		0.5	Factory adjustment
Temperature coefficient of G	$TCG$	ppm/K	-200		200	-40 °C ... 105 °C
Linearity error 0 ... $I_{PN}$	$\epsilon_L$	% of $I_{PN}$	-0.5		0.5	
Linearity error 0 ... $I_{PM}$	$\epsilon_L$	% of $I_{PM}$	-0.5		0.5	
Magnetic offset current (@ $10 \times I_{PN}$ ) referred to primary	$I_{OM}$	A	-0.25		0.25	
Reaction time @ 10 % of $I_{PN}$	$t_{ra}$	$\mu\text{s}$			2	@ 50 A/ $\mu\text{s}$
Response time @ 90 % of $I_{PN}$	$t_r$	$\mu\text{s}$			2.5	@ 50 A/ $\mu\text{s}$
Frequency bandwidth (-3 dB)	$BW$	kHz		400		
Output rms voltage noise spectral density 100 Hz ... 100 kHz	$e_{no}$	$\mu\text{V}/\sqrt{\text{Hz}}$			8.75	
Output voltage noise DC ... 10 kHz DC ... 100 kHz DC ... 1 MHz	$V_{no}$	mVpp		6.2 14 20.7		
Accuracy @ $I_{PN}$	$X$	% of $I_{PN}$	-1		1	
Accuracy @ $I_{PN}$ @ $T_A = +85\text{ °C}$	$X_{85\text{ °C}}$	% of $I_{PN}$	-2.9		2.9	See formula note <sup>2)</sup>
Accuracy @ $I_{PN}$ @ $T_A = +105\text{ °C}$	$X_{105\text{ °C}}$	% of $I_{PN}$	-3.4		3.4	See formula note <sup>2)</sup>

 Notes: <sup>1)</sup> 3.3 V SP version available

$$^2) \text{ Accuracy @ } T_A (\% \text{ of } I_{PN}) = X + \left( \frac{TCG}{10000} \times (T_A - 25) + \frac{TCI_{OE}}{1000 \times I_P} \times 100 \times (T_A - 25) \right)$$

**Electrical data HLSR 40-P**

 At  $T_A = 25\text{ °C}$ ,  $U_C = +5\text{ V}$ ,  $R_L = 10\text{ k}\Omega$  unless otherwise noted (see Min, Max, typ. definition paragraph in page 10).

Parameter	Symbol	Unit	Min	Typ	Max	Comment
Primary nominal rms current	$I_{PN}$	A		40		
Primary current, measuring range	$I_{PM}$	A	-100		100	For $U_C > 4.6\text{ V}$
Number of primary turns	$N_P$	-		1		
Resistance of primary jumper @ $T_A = 25\text{ °C}$	$R_P$	m $\Omega$		0.21		
Resistance of primary jumper @ $T_A = 105\text{ °C}$	$R_P$	m $\Omega$		0.29		T jumper = 120 °C
Supply voltage <sup>1)</sup>	$U_C$	V	4.5	5	5.5	
Current consumption	$I_C$	mA		19	25	
Reference voltage (output)	$V_{ref}$	V	2.48	2.5	2.52	Internal reference
Reference voltage (input)	$V_{ref}$	V	0.5		2.65	External reference
Output voltage range @ $I_{PM}$	$V_{out} - V_{ref}$	V	-2		2	Over operating temperature range
$V_{ref}$ output resistance	$R_{ref}$	$\Omega$	130	200	300	series
$V_{out}$ output resistance	$R_{out}$	$\Omega$		2	5	series
Capacitive loading	$C_L$	nF	0		6	
Electrical offset voltage @ $I_P = 0$	$V_{OE}$	mV	-5		5	$V_{out} - V_{ref}$ @ $V_{ref} = 2.5\text{ V}$
Electrical offset current referred to primary	$I_{OE}$	mA	-250		250	
Temperature coefficient of $V_{ref}$	$TCV_{ref}$	ppm/K	-170		170	-40 °C ... 105 °C
Temperature coefficient of $V_{OE}$	$TCV_{OE}$	mV/K	-0.075		0.075	-40 °C ... 105 °C
Temperature coefficient of $I_{OE}$	$TCI_{OE}$	mA/K	-3.75		3.75	-40 °C ... 105 °C
Theoretical sensitivity	$G_{th}$	mV/A		20		800 mV @ $I_{PN}$
Sensitivity error	$\epsilon_G$	%	-0.5		0.5	Factory adjustment
Temperature coefficient of G	$TCG$	ppm/K	-200		200	-40 °C ... 105 °C
Linearity error 0 ... $I_{PN}$	$\epsilon_L$	% of $I_{PN}$	-0.5		0.5	
Linearity error 0 ... $I_{PM}$	$\epsilon_L$	% of $I_{PM}$	-0.5		0.5	
Magnetic offset current (@ $10 \times I_{PN}$ ) referred to primary	$I_{OM}$	A	-0.25		0.25	
Reaction time @ 10 % of $I_{PN}$	$t_{ra}$	$\mu$ s			2	@ 50 A/ $\mu$ s
Response time @ 90 % of $I_{PN}$	$t_r$	$\mu$ s			2.5	@ 50 A/ $\mu$ s
Frequency bandwidth (-3 dB)	$BW$	kHz		400		
Output rms voltage noise spectral density 100 Hz ... 100 kHz	$e_{no}$	$\mu$ V/ $\sqrt{\text{Hz}}$			7	
Output voltage noise DC ... 10 kHz DC ... 100 kHz DC ... 1 MHz	$V_{no}$	mVpp		5.1 11.1 16.6		
Accuracy @ $I_{PN}$	X	% of $I_{PN}$	-1		1	
Accuracy @ $I_{PN}$ @ $T_A = +85\text{ °C}$	$X_{85\text{ °C}}$	% of $I_{PN}$	-2.9		2.9	See formula note <sup>2)</sup>
Accuracy @ $I_{PN}$ @ $T_A = +105\text{ °C}$	$X_{105\text{ °C}}$	% of $I_{PN}$	-3.4		3.4	See formula note <sup>2)</sup>

 Notes: <sup>1)</sup> 3.3 V SP version available

$$^2) \text{ Accuracy @ } T_A (\% \text{ of } I_{PN}) = X + \left( \frac{TCG}{10000} \times (T_A - 25) \right) + \left( \frac{TCI_{OE}}{1000 \times I_P} \times 100 \times (T_A - 25) \right).$$



**Electrical data HLSR 50-P**

 At  $T_A = 25\text{ °C}$ ,  $U_C = +5\text{ V}$ ,  $R_L = 10\text{ k}\Omega$  unless otherwise noted (see Min, Max, typ. definition paragraph in page 10).

Parameter	Symbol	Unit	Min	Typ	Max	Comment
Primary nominal rms current	$I_{PN}$	A		50		
Primary current, measuring range	$I_{PM}$	A	-125		125	For $U_C > 4.6\text{ V}$
Number of primary turns	$N_P$	-		1		
Resistance of primary jumper @ $T_A = 25\text{ °C}$	$R_P$	m $\Omega$		0.21		
Resistance of primary jumper @ $T_A = 105\text{ °C}$	$R_P$	m $\Omega$		0.29		T jumper = 120 °C
Supply voltage <sup>1)</sup>	$U_C$	V	4.5	5	5.5	
Current consumption	$I_C$	mA		19	25	
Reference voltage (output)	$V_{ref}$	V	2.48	2.5	2.52	Internal reference
Reference voltage (input)	$V_{ref}$	V	0.5		2.65	External reference
Output voltage range @ $I_{PM}$	$V_{out} - V_{ref}$	V	-2		2	Over operating temperature range
$V_{ref}$ output resistance	$R_{ref}$	$\Omega$	130	200	300	series
$V_{out}$ output resistance	$R_{out}$	$\Omega$		2	5	series
Capacitive loading	$C_L$	nF	0		6	
Electrical offset voltage @ $I_P = 0$	$V_{OE}$	mV	-5		5	$V_{out} - V_{ref}$ @ $V_{ref} = 2.5\text{ V}$
Electrical offset current referred to primary	$I_{OE}$	mA	-313		313	
Temperature coefficient of $V_{ref}$	$TCV_{ref}$	ppm/K	-170		170	-40 °C ... 105 °C
Temperature coefficient of $V_{OE}$	$TCV_{OE}$	mV/K	-0.05		0.05	-40 °C ... 105 °C
Temperature coefficient of $I_{OE}$	$TCI_{OE}$	mA/K	-3.125		3.125	-40 °C ... 105 °C
Theoretical sensitivity	$G_{th}$	mV/A		16		800 mV @ $I_{PN}$
Sensitivity error	$\epsilon_G$	%	-0.5		0.5	Factory adjustment
Temperature coefficient of G	$TCG$	ppm/K	-200		200	-40 °C ... 105 °C
Linearity error 0 ... $I_{PN}$	$\epsilon_L$	% of $I_{PN}$	-0.5		0.5	
Linearity error 0 ... $I_{PM}$	$\epsilon_L$	% of $I_{PM}$	-0.5		0.5	
Magnetic offset current (@ $10 \times I_{PN}$ ) referred to primary	$I_{OM}$	A	-0.25		0.25	
Reaction time @ 10 % of $I_{PN}$	$t_{ra}$	$\mu\text{s}$			2	@ 50 A/ $\mu\text{s}$
Response time @ 90 % of $I_{PN}$	$t_r$	$\mu\text{s}$			2.5	@ 50 A/ $\mu\text{s}$
Frequency bandwidth (-3 dB)	$BW$	kHz		400		
Output rms voltage noise spectral density 100 Hz ... 100 kHz	$e_{no}$	$\mu\text{V}/\sqrt{\text{Hz}}$			5.6	
Output voltage noise DC ... 10 kHz DC ... 100 kHz DC ... 1 MHz	$V_{no}$	mVpp		4.3 8.8 13.3		
Accuracy @ $I_{PN}$	$X$	% of $I_{PN}$	-1		1	
Accuracy @ $I_{PN}$ @ $T_A = +85\text{ °C}$	$X_{85\text{ °C}}$	% of $I_{PN}$	-2.7		2.7	See formula note <sup>2)</sup>
Accuracy @ $I_{PN}$ @ $T_A = +105\text{ °C}$	$X_{105\text{ °C}}$	% of $I_{PN}$	-3.1		3.1	See formula note <sup>2)</sup>

 Notes: <sup>1)</sup> 3.3 V SP version available

$$^2) \text{ Accuracy @ } T_A (\% \text{ of } I_{PN}) = X + \left( \frac{TCG}{10000} \times (T_A - 25) \right) + \left( \frac{TCI_{OE}}{1000 \times I_P} \times 100 \times (T_A - 25) \right).$$

**HLSR-P series, maximum continuous DC current**

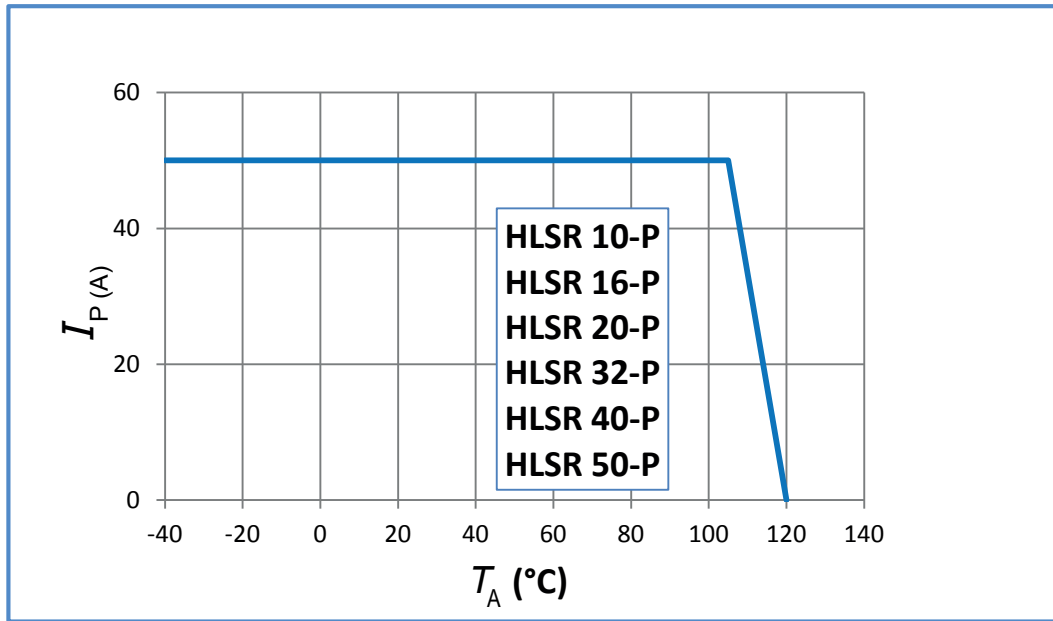

Important notice: whatever the usage and/or application, the transducer jumper temperature shall not go above the maximum ratings of 120 °C as stated in page 2 of this datasheet.

**Definition of typical, minimum and maximum values**

Minimum and maximum values for specified limiting and safety conditions have to be understood as such as well as values shown in “typical” graphs.

On the other hand, measured values are part of a statistical distribution that can be specified by an interval with upper and lower limits and a probability for measured values to lie within this interval.

Unless otherwise stated (e.g. “100 % tested”), the LEM definition for such intervals designated with “min” and “max” is that the probability for values of samples to lie in this interval is 99.73 %.

For a normal (Gaussian) distribution, this corresponds to an interval between -3 sigma and +3 sigma. If “typical” values are not obviously mean or average values, those values are defined to delimit intervals with a probability of 68.27 %, corresponding to an interval between -sigma and +sigma for a normal distribution.

Typical, minimum and maximum values are determined during the initial characterization of the product.

HLSR-P series, measuring range versus external reference voltage

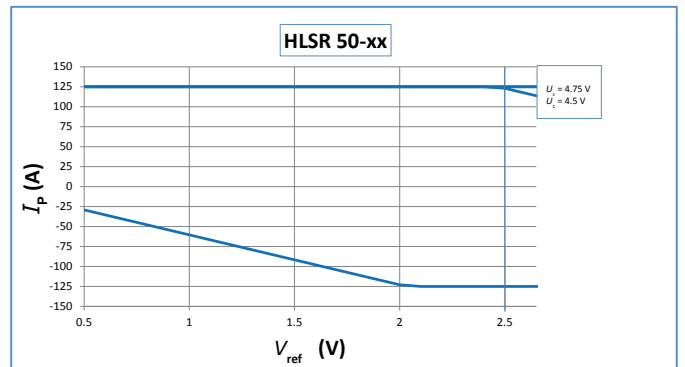
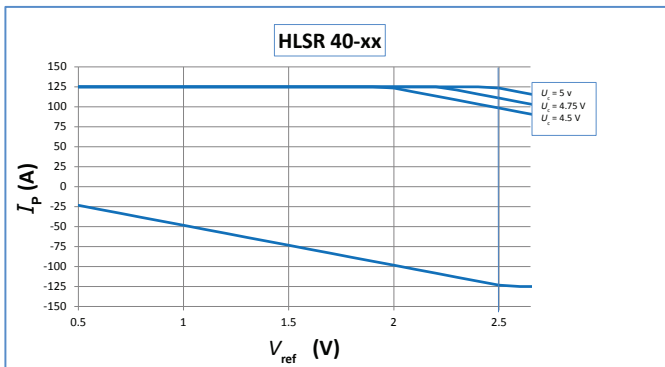
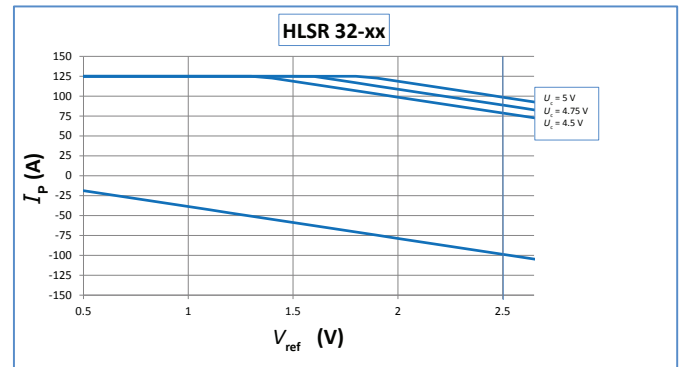
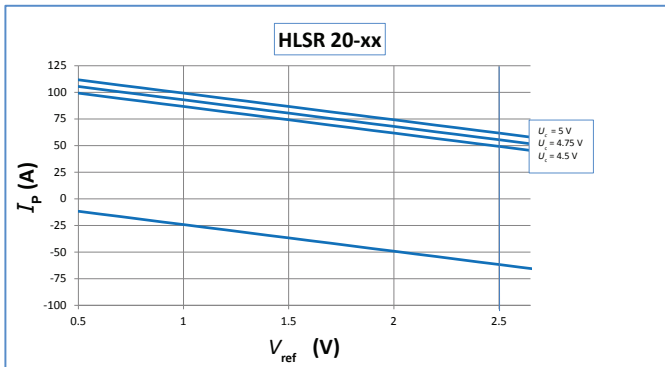
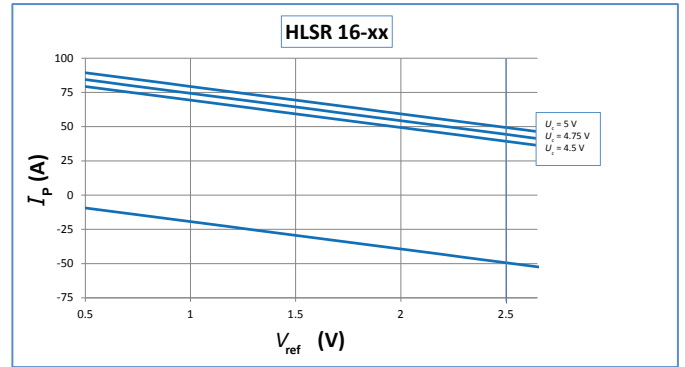
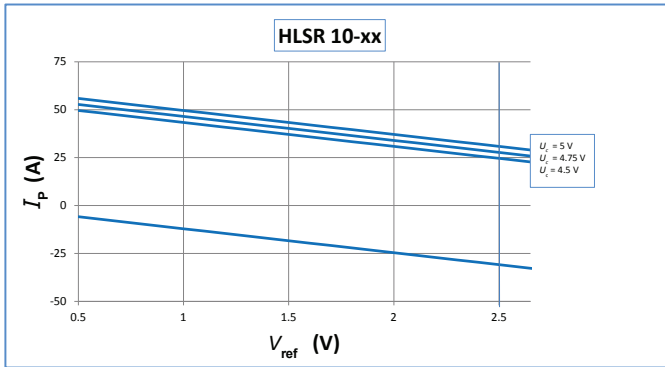



**HLSR-P series Dimensions** (in mm. General linear tolerance  $\pm 0.2$  mm)

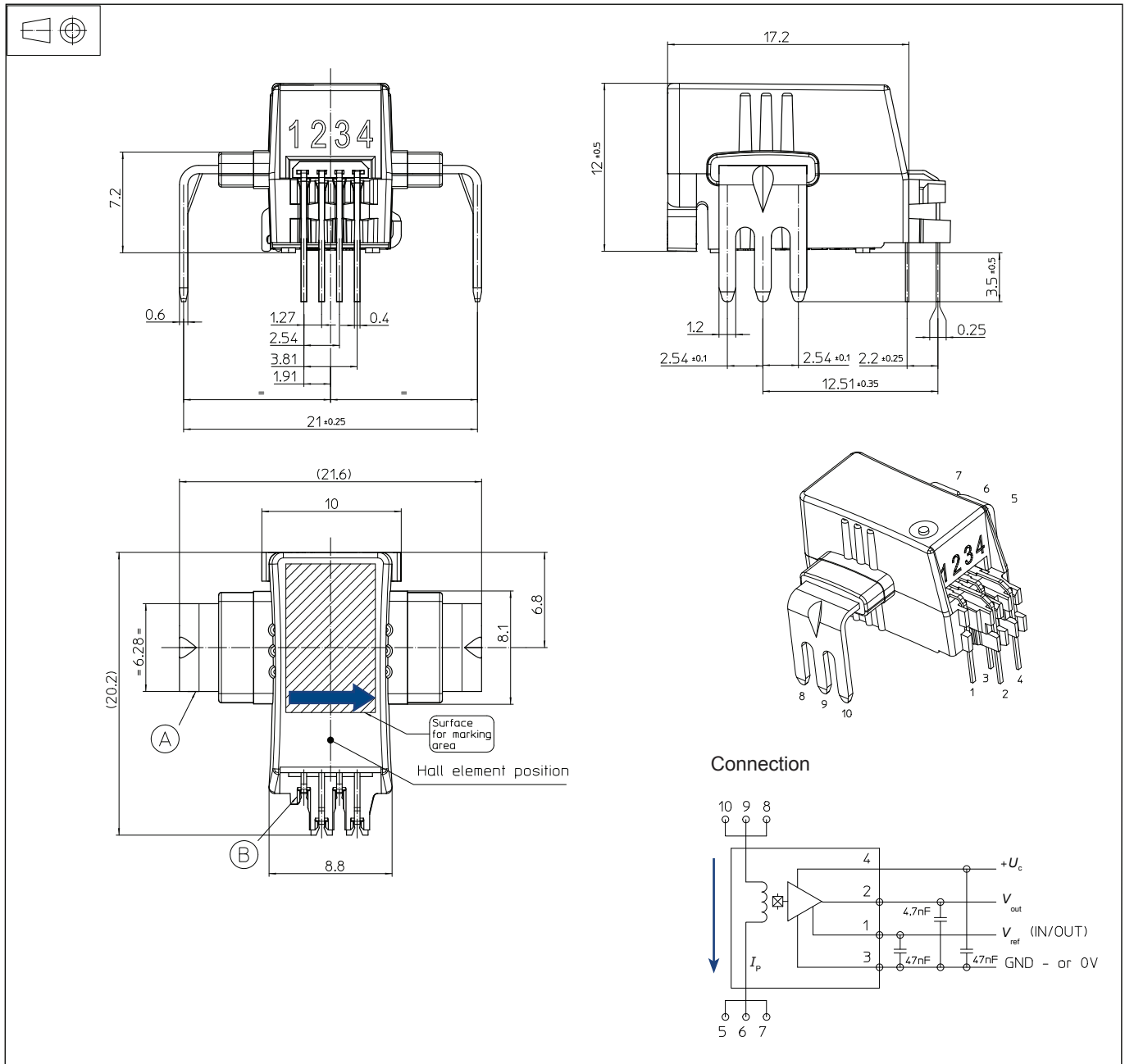

**Remarks**

- $V_{out}$  is positive with respect to  $V_{ref}$  when positive  $I_p$  flows in direction of the arrow shown on the drawing above
- Installation of the transducer must be done unless otherwise specified on the datasheet, according to LEM Transducer Generic Mounting Rules. Please refer to LEM document N°ANE120504 available on our Web site: [Products/Product Documentation](#).

## X-ON Electronics

Largest Supplier of Electrical and Electronic Components

*Click to view similar products for [Lem manufacturer](#):*

Other Similar products are found below :

[FHS 40-P KIT 4-1P](#) [FHS 40-P KIT 7-1P](#) [AT5B420L](#) [DHR 400 C10](#) [ATO-60-B225-D10](#) [IT 405-S](#) [ULTRASTAB](#) [HAS50-S/SP50](#) [CASR15-NP](#) [LA125-P](#) [RT 500](#) [FHS 40-P KIT 9-1P](#) [LF 205-S](#) [DVL 500](#) [DVL 750](#) [DVL 1000-UI](#) [AT100B10](#) [DIN RAIL ADAPTER ATO-D10](#) [DIN RAIL ADAPTER ATO-D16](#) [HO 200-/SP30](#) [AT150B420L](#) [DHR 100 C420](#) [HAIS 150-P](#) [AT 10 B10](#) [HO 150-/SP30](#) [DVL 1500-UI](#) [APR 50 B10](#) [DVL 750-UI](#) [HO 40-NP-0100](#) [CASR6-NP](#) [LAH100-P](#) [DHAB S/118](#) [LF205-S](#) [HO 250-/SP30](#) [LF 210-S](#) [hat800-s](#) [HAT400-S](#) [ART-B22-D070](#) [HO 50-S/SP33-1106](#) [RT 2000](#) [HX 03-P/SP2](#) [HTFS 400-P/SP2](#) [AP 50 B10](#) [DVL 2000](#) [HO 60-NP](#) [AP 50 B420L](#) [DVL 1500](#) [CAS25-NP](#) [DHR 200 C420](#) [HO 180-P](#) [HY 25-P](#)