



# CORNER14 EF/TY

## ANGULAR PROFILE 30°/60°

### PROFIL KĄTOWY 30°/60°

- decorative and lighting profile
- hidden mountings
- two lighting angles: 30°/60°
- maximum LED strip width: 14 mm
- profil dekoracyjno-oświetleniowy
- ukryte mocowania
- dwa kąty świecenia: 30°/60°
- maksymalna szerokość taśmy LED: 14 mm



## SIMILAR IN THE OFFER / PODOBNE W OFERCIE



TRIO10  
BC



CORNER10  
BC/UX



QUARTER10  
BD/U6



CABI12  
E



CORNER27  
G/UX



# CORNER14 EF/TY

- E** slide cover  
klosz E wsuwany
- F** click cover  
klosz F klik
- Y**<sup>1</sup> Y flexible mounting plate  
uchwyt Y sprężysty
- Y**<sup>2</sup> cone Y flexible mounting plate  
uchwyt Y sprężysty cone
- T** mounting plate  
uchwyt T

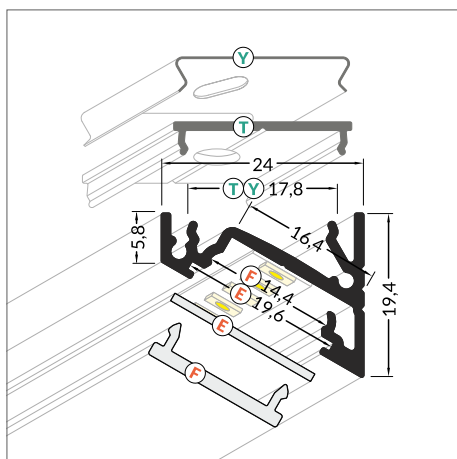
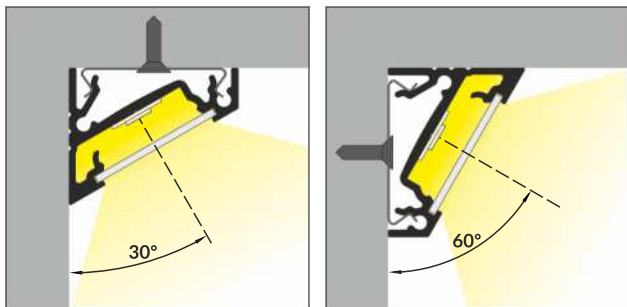
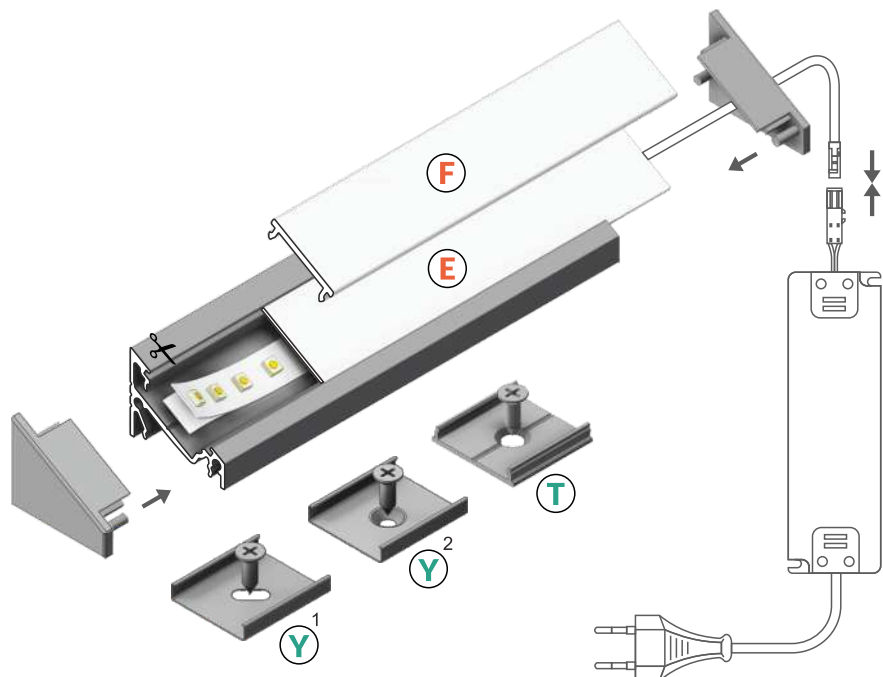

INDEX = 1 pc, length 2000 mm  
package = 10 pcs  
INDEKS = 1 szt., długość 2000 mm  
opakowanie = 10 szt.

 white painted  
biały malowany  
A4020001

 anodized  
anodowany  
A4020020

 black anodized  
czarny anodowany  
A4020021

 raw aluminium  
surowe aluminium  
A4020000

Available lengths / Dostępne długości  
1000 mm, 2000 mm, 3000 mm, 4000 mm



## COVERS / KLOSZE

### E slide cover

colours: transparent, frosted, white  
material: PC, PP, PP

klosz E wsuwany  
kolory: transparentny, szron, mleczny  
materiał: PC, PP, PP



**Note!** Dimensions of the space to install LED source  
**Uwaga!** Wymiary przestrzeni do zamontowania źródła LED

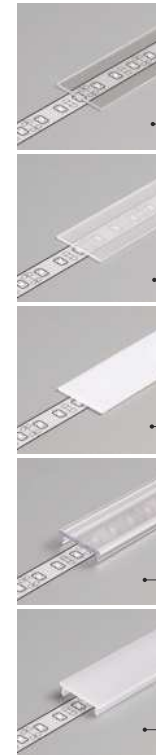
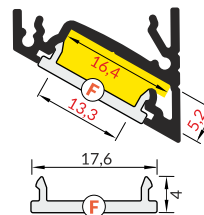
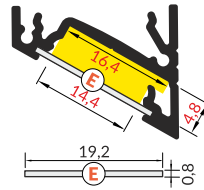

INDEX = 1 pc, length 2000 mm  
package = 10 pcs  
INDEKS = 1 szt., długość 2000 mm  
opakowanie = 10 szt.

E transparent / E transparentny  
A2040016

E frosted / E szron  
A2040039

E white / E mleczny  
A2040038

F transparent / F transparentny  
A2060016

F white / F mleczny  
A2060038

### F click cover

colours: transparent, white  
material: PMMA

klosz F klik  
kolory: transparentny, mleczny  
materiał: PMMA

E7 click cover  
colour: white  
material: PMMA



klosz E7 klik  
kolor: mleczny  
materiał: PMMA

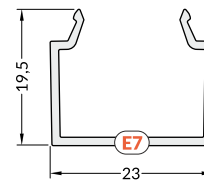

E7 white / E7 mleczny  
C1080038

E7 white ending  
zaślepka E7 mleczny  
C1840038

## MOUNTING / MOCOWANIA

### Y flexible mounting plate

colour: inox  
material: stainless steel

uchwyt Y sprężysty  
kolor: inox  
materiał: stal nierdzewna

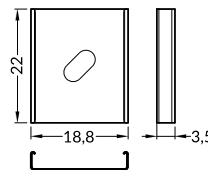
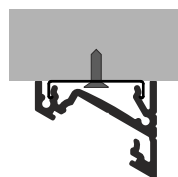

INDEX = 1 set  
package of 10 sets = 20 pcs  
INDEKS = 1 komplet, opakowanie  
zawiera 10 kompletów = 20 szt.

Y flexible mounting plate  
uchwyt Y sprężysty



A2090019

### cone Y flexible mounting plate

colour: inox  
material: stainless steel

uchwyt Y sprężysty cone  
kolor: inox  
materiał: stal nierdzewna

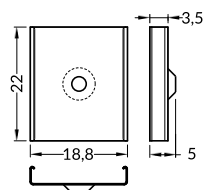
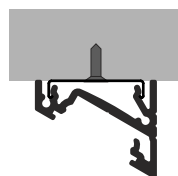

cone Y flexible mounting plate  
uchwyt Y sprężysty cone



A2130019

### T mounting plate

colour: raw aluminium  
material: aluminium

uchwyt T  
kolor: surowe aluminium  
materiał: aluminium

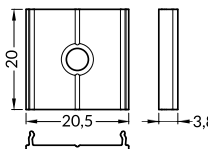
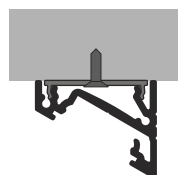

T mounting plate  
uchwyt T

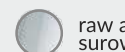

raw aluminium  
surowe aluminium  
C6960000



## ENDINGS / ZAŚLEPKI

### CORNER14 ending

colours: white, silver, black, grey  
material: ABS

zaślepka CORNER14

kolory: biały, srebrny, czarny, szary  
materiał: ABS

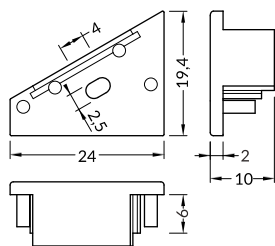

### CORNER14 ending with hole

colours: white, silver, black, grey  
material: ABS

zaślepka CORNER14 z otworem

kolory: biały, srebrny, czarny, szary  
materiał: ABS

INDEX = 1 set  
package of 10 sets = 20 pcs  
INDEKS = 1 komplet, opakowanie  
zawiera 10 kompletów = 20 szt.

white  
białe

with hole  
z otworem  
A4050001

without hole  
bez otworu  
A4070001

silver  
srebrne

with hole  
z otworem  
A4050040

without hole  
bez otworu  
A4070040

black  
czarne

with hole  
z otworem  
A4050002

without hole  
bez otworu  
A4070002

grey  
szare

with hole  
z otworem  
A4050022

without hole  
bez otworu  
A4070022

## CONNECTORS / ŁĄCZNIKI

### T connector

colour: raw aluminium  
material: aluminium

łącznik T

kolor: surowe aluminium  
materiał: aluminium

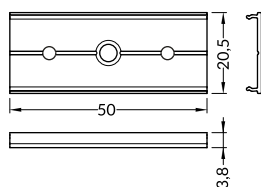

### CORNER14 connector 90 deg

colours: white, anodized, black  
material: aluminium

łącznik CORNER14 90 st

kolory: biały, anodowany, czarny  
materiał: aluminium

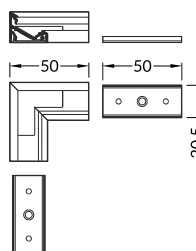

INDEX = 1 set  
INDEKS = 1 komplet

T connector / łącznik T

raw aluminium  
surowe aluminium  
C6990000

connector 90 deg / łącznik 90 st

white painted  
biały malowany  
A4990001

anodized  
anodowany  
A4990020

black anodized  
czarny anodowany  
A4990021

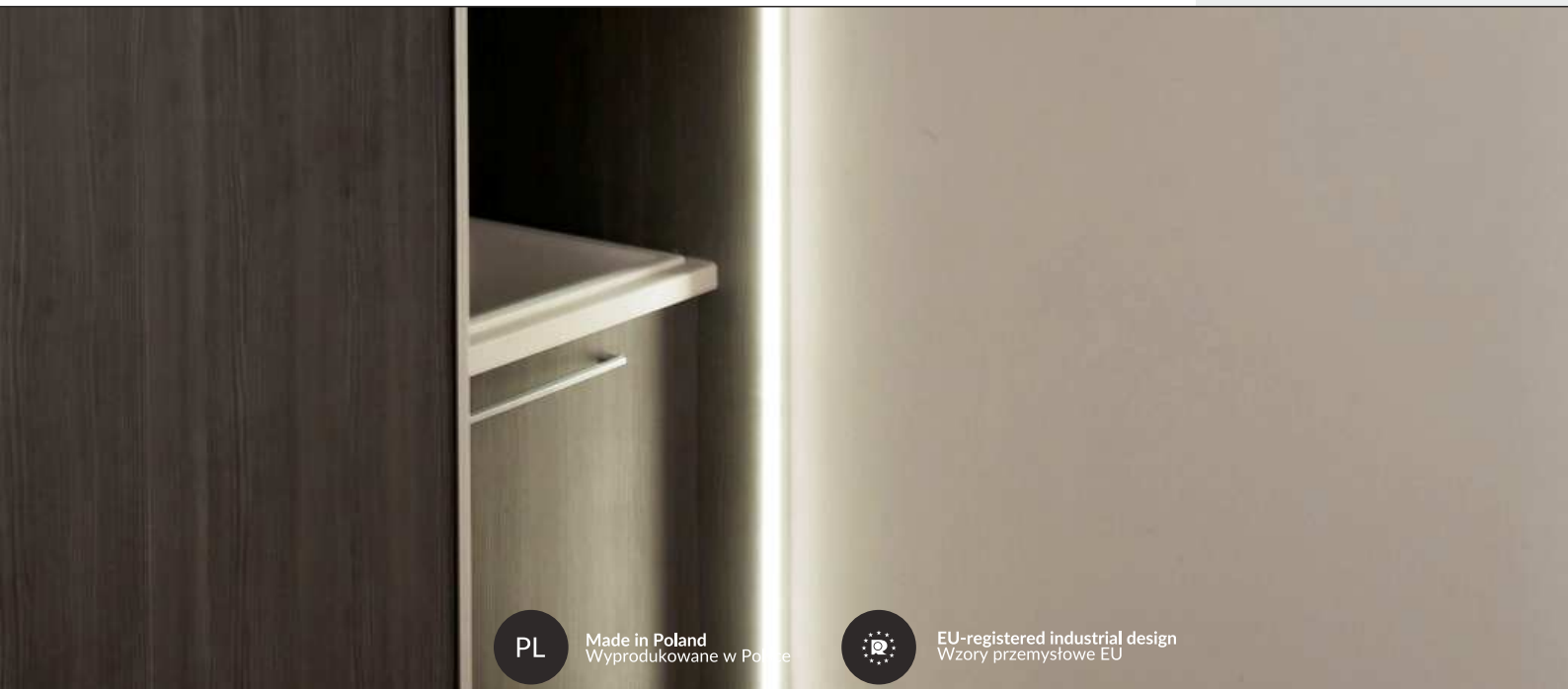

PL

Made in Poland  
Wyprodukowane w Polsce



EU-registered industrial design  
Wzory przemysłowe EU

TOPMET LIGHT Kłosowicz Wiśniowicki i Wspólnik Sp. j. ADDRESS: Ostrowska 354, 61-312 Poznań, POLAND  
tel. +48 61 87 27 500, fax. +48 61 87 27 518 biuro@topmet.pl, www.topmet.pl

The catalogue is not an offer under Polish Civil Code regulations. Colours of particular products may vary slightly from colours shown in pictures. The dimensions given are approximate and can not be a reason for complaint. TOPMET Company reserves the right to make technical changes.

Folder nie stanowi oferty w myśl przepisów Kodeksu Cywilnego. Aktualną ofertę firmy stanowi cennik. Kolory poszczególnych produktów mogą się nieznacznie różnić od kolorów prezentowanych na zdjęciach. Podane wymiary są wymiarami orientacyjnymi i nie mogą stanowić podstawy reklamacji. Firma TOPMET zastrzega sobie prawo do wprowadzania zmian technicznych.

brochure designer • proj. folderu: M. Kedziora, A. Szafran 11.2016. photo • fot. K. Samulska, A. Szafran, L. Wesołowski

# X-ON Electronics

Largest Supplier of Electrical and Electronic Components

*Click to view similar products for [LED Lighting Mounting Accessories](#) category:*

*Click to view products by [Topmet](#) manufacturer:*

Other Similar products are found below :

[3635](#) [PALBF18](#) [C16142\\_HEKLA-SOCKET-K](#) [3SU1900-0BC31-0AA0](#) [3SU1900-0BC31-0NB0](#) [2213118-2](#) [47.319.6380.50](#) [3SU1401-2BB40-1AA0](#) [3SU1401-2BB60-1AA0](#) [1SFA611621R1041](#) [23110040](#) [23120022](#) [23130000](#) [68550022](#) [68550040](#) [70290000](#) [70290022](#) [70290040](#) [70300022](#) [70300040](#) [76620000](#) [76990022](#) [77280022](#) [77980022](#) [77990001](#) [77990002](#) [77990040](#) [83130001](#) [83130040](#) [83150001](#) [83150022](#) [83150040](#) [83980001](#) [83980040](#) [83990001](#) [83990022](#) [83990040](#) [84040022](#) [84510002](#) [86050038](#) [86180003](#) [89080002](#) [89080022](#) [89140002](#) [89980002](#) [89980019](#) [98050040](#) [A1070001](#) [A1070002](#) [A2070001](#)