

SPECIFICATION

FOR

EUROPEAN JUMPER CORDSET (PB FR)

CORD : H05VV-F 3X1.00mm² PVC LEAD FREE

CUSTOMER : VPE/FARNELL

CUSTOMER'S PART No. : 2467623

VOLEX'S SPEC. REF. No. : 152129/1

ISSUE No. : 001

DATE : 30TH JANUARY 2015

CUSTOMER APPROVED :

APPROVED BY :

SIGNATURE :

APPROVED DATE :

No. OF PAGES :



Vollex (Asia) Pte Ltd

35 Tampines St. 92
Singapore 528880
Tel : (65) 6788 7833
Fax : (65) 6788 7822

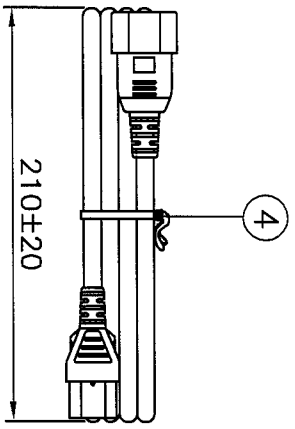
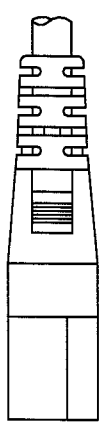
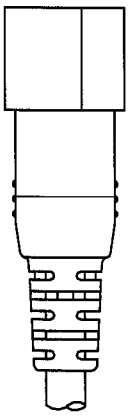
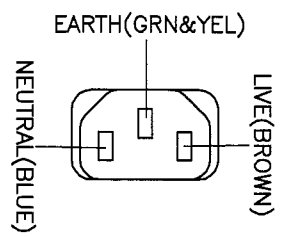
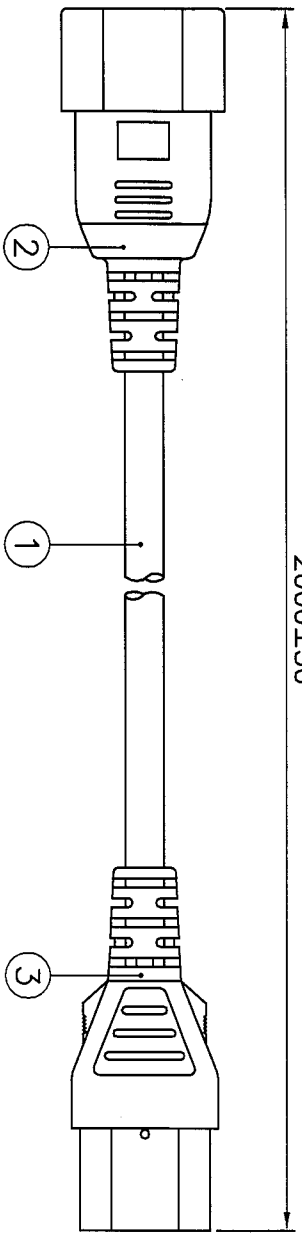
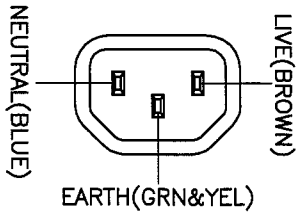

APPROVED SOURCE FOR CABLE

1. BAO HING(SHENZHEN).

NOTE :

1. ALL DIMENSIONS IN mm.
2. THE CORD SHALL COMPLY WITH EN 50525-2-11.
3. THE MOLDED PLUG CONNECTOR SHALL COMPLY WITH IEC 60320-2-2/EN 60320-2-2 & IEC 60320-1/EN 60320-1.
4. THE MOLDED CONNECTOR SHALL COMPLY WITH IEC 60320-1 OR EN 60320-1.
5. THIS PART CAN BE MANUFACTURED AT ANY LOCATION WHICH HAS SAFETY APPROVAL.

4	6" PE TIE BLK	6310056	1
3	IP60G NL7976B BLK	4100115	-
	MOLDED CONNECTOR V1625 (10A 250V)	V1625	1
2	IP60G NL7976B BLK	4100115	-
	MOLDED PLUG VAC14S (10A 250V)	VAC14S-BK	1
1	H05W-F 3X1.00 BLK PVC LEAD FREE	1210365	1
S/N	DESCRIPTION	ITEM NUMBER	QTY
TITLE : EUROPEAN JUMPER CORDESET (PB FR)			
CUSTOMER : VPE/FARNELL			
CUSTOMER PART NUMBER : 2467623			
Reference Number : 152129/1 (HG01-233-15)			
SALES : QA :			ISSUE
Date :			001
Reference Number : 152129/1 (HG01-233-15)			
ENGRG :	CHECKED BY :	DRAWN BY :	
DATE :	DATE :	DATE :	
30/01/15	30/01/15	30/01/15	
<p><i>Confidential property of Volax. Information contained herein shall not be used for any other purposes without the written authorization of Volax Asia. Volax Asia is an authorized official of Volax Asia.</i></p>			

Volax (Asia) Pte Ltd

PAGE : 1/1

SCALE : N.T.S.

REV.	DESCRIPTION	DATE
1	REMOVE INSULATION COLOR 'BLUE, BROWN, BLACK'	01/09/06
	FM, REV. H PER HD STANDARD.	
	CHANGE THE COMPLIANCE STANDARD	
	PER SAFETY.	
J	UPDATE FORMAT AS SHOWN.	23/12/13

1. PVC FLEXIBLE CORD

1.1 SCOPE

This specification shall be in accordance with EN 50525-2-11. 

1.2 CONSTRUCTION

CONDUCTOR	ANNEALED COPPER WIRE
INSULATION	PVC (BLUE, BROWN, GREEN&YELLOW)
JACKET	PVC

ITEM	UNIT	SPEC. VALUE
TEMPERATURE RATING	°C	70
RATED VOLTAGE	V	300/500
NO. OF CORE	NO.	3
CONDUCTOR NOMINAL AREA	mm ²	1.00
MIN. AVE. THICKNESS OF INSULATION	mm	0.60
MIN. THICKNESS AT ANY POINT OF INSULATION	mm	0.44
MIN. AVE. THICKNESS OF JACKET	mm	0.80
MIN. THICKNESS AT ANY POINT OF JACKET	mm	0.58
OVERALL DIAMETER OF JACKET	mm	6.3~8.0
DILECTRIC-STRENGTH TEST IMMERSIED ON COMPLETED CABLE		2000 V FOR 15 MINS (MINIMUM)
IN WATER, 20±5°C FOR MINIMUM 1HR		1500 V FOR 5 MINS (MINIMUM)
VOLTAGE TEST (D.C)		2000 V _{d.c} FOR 5 MINS (MINIMUM) OR 5000 V _{d.c} FOR 5 MINS (MINIMUM)
INSULATION RESISTANCE TEST (70°C)	MΩ km	> 0.01
CONDUCTOR RESISTANCE TEST (20°C)	Ω/km	≤ 19.5

TITLE : CABLE SPECIFICATION
 EUROPEAN APPROVED POWER SUPPLY CABLE
 H05VV-F 3X1.00mm²

CS-048EU

SPEC NO. :

DATE : 20/12/13

DATE : 27/12/13

DATE : 23/12/13

PAGE : 1/1

APPROVED BY : 

CHECKED BY : 

DRAWN BY : HONGYAN

REVISION : J

 Volox (Asia) Pte Ltd

Confidential property of Volox. Information contained herein shall not be disclosed to others, reproduced or used for any other purpose except as authorized in writing by an authorized official of Volox sale.

CABLE MARKING

BAO HING (SHENZHEN)

HOSW-F 3G1.0mm² >VDE> >KEMA-KEUR + s + s + s
 >OVE> >CEBEC IEMMEQU SABS 1574 (S) (N) (D) (FI)
 BAOHING GISA-3 N14586 CE LF

REV.	DESCRIPTION	DATE
A	INITIAL RELEASE	12/10/02
B	UPDATE MARKING DETAILS.	19/01/05
	UPDATE THE FORMAT AS SHOWN.	
	ADD IN '(EU/SAA/SAB/IEC)' ON THE TITLE.	

Confidential property of Volex. Information contained herein shall not be disclosed to others, reproduced or used for any other purposes except as authorized in writing by an authorized official of Volex Asia.		HOSW-F 3X1.0mm ² LF	
Volex (Asia) Pte Ltd		REFERENCE :	
CABLE MARKING (EU/SAA/SAB/IEC)	FILENAME :	19/01/05	LI XF
	CABLE MARKING/	19/1/05	Wolfe
	BR/HOS/HOSW-F	19/01/05	Changpin
	3X1.0 LF - BH		
	B	REV.	N.T.S.

CONFIDENTIAL PROPERTY OF VOLEX. Information contained herein shall not be disclosed to others, reproduced or used for any other purposes except as authorized in writing by an authorized official of Volex Asia.	
REFERENCE: Volex (Asia) Pte Ltd	
TITLE : EUROPEAN & BRITISH PLUG CONNECTOR	DRAWN: XIAOZHI CHECK: [Signature] APPR: [Signature] REV: T
	03/06/13 03/06/13 3/6/13

NO.	TEST ITEM	DESCRIPTION	ACCEPTANCE CRITERIA
1.	Moisture resistance test	Samples are kept in a humidity cabinet containing air with a relative humidity between 91 to 95% and a temperature of 20°C-30°C for a duration of 48 hours.	No damage
2.	Electric strength test	Voltagess of 3000V±60V and 1500V±60V, with min. trip current of 100mA is applied for 60s±5s between current-carrying contacts and body and between each contacts respectively after the moisture resistance tests.	No flashover and breakdown
3.	Insulation resistance test	This test is measured with a D.C 500V after the after 60s ± 5s of application of voltage. moisture resistance test. Readings are taken	Min. 5 M Ohm
4.	Glow wire test	Glow wire is applied for 30s with temperature of 750°C on inserts and housings retaining contacts and 650°C on elsewhere.	Flame (if any) shall be self-extinguished within 30s upon the removal of the glow wire and molten droplets shall not ignite paper.

3.3. CHARACTERISTICS

"All Connectors complying to Standard Sheet C14 and C20"

& VAC20KC.

The connector construction shall comply with our catalogue No: VAC14S, VAC14A, VAC20S, VAC14LS, VAC14KC, VAC14KAL, VAC14KAR, VAC14LA, VAC20KAL, VAC20KAR

3.2. CONSTRUCTION

EN 60320-1 : Test specification - appliance couplers.

The connector shall be in accordance with IEC 60320-2-2 / EN 60320-2-2 & IEC 60320-1 /

3.1. SCOPE

3. CONNECTOR

REV	DESCRIPTION	DATE
	CHANGE TEST RESULT TO ACCEPTANCE CRITERIA.	11/03/13
S	CHANGE FORMAT AS SHOWN.	11/03/13
T	ADD IN CATALOGUE NO. 'VAC14LA'	03/06/13

INFORMATION CONTAINED HEREIN SHALL NOT BE DISCLOSED TO OTHERS, REPRODUCED OR USED FOR ANY OTHER PURPOSE EXCEPT AS AUTHORIZED IN WRITING BY AN AUTHORIZED OFFICIAL OF VOLEX ASIA.	
Confidential property of Volex.	
REFERENCE:	
TITLE: EUROPEAN & BRITISH PLUG CONNECTOR	
DRAWN: XIAOZH	03/06/13
CHECK: <i>[Signature]</i>	03/06/13
APPR: <i>[Signature]</i>	3/6/13
REV: 1	3/6/13

NO.	TEST ITEM	DESCRIPTION	ACCEPTANCE CRITERIA
5.	Bending test	The sample shall be loaded with a weight of 10N for 0.75mm ² or 20N for 1.00mm ² or bigger and the oscillating member shall be moved backward and forward through an angle of 90°(45° on either side of the vertical) the number of flexing being 20,000. A rated current is applied. For round cord, the sample is turned 90 degree around the axis of cable after 10,000 cycles. The flexing is further completed in this axis. Flat cable is flexed only along the bigger axis of the cable.	Broken conductor shall not have pierced the insulation. There shall be no complete breakage of any of the conductor.
6.	Tumbling test	The sample is dropped from a height of 50cm onto a steel plate(3mm thick) for a total of 500 times.	No damage to impact further use of connector.
7.	Temperature rise test	An alternating current at 1.25 times rated current is passed through the current carrying contacts for 1 hour. This is repeated for connector with earth contact passing current between earth and each of the current carrying contacts.	The temperature rise shall not exceed 45K.
8.	Cord-anchorage test	The cord is subjected to pulls of 50N(2.5A) or 60N(others) for 100 times each time for 1 sec. without jerk. Thereafter the cord is subjected for 1 min. to a torque of 0.15Nm(0.75mm ²) or 0.25Nm(others).	The cord shall not be damaged and shall not be displaced by more than 2mm.
9.	Heat deformation test	Samples are kept for 1 hour in a heating cabinet at temperature of 100±2°C.	No damage to impact further use of connector.
10.	Heat pressure test	A pressure of 20N is applied at a temperature of 100°C ± 2°C for 1 hour.	No damage to impact further use of connector.
11.	Ageing test	The samples are kept for 168 hours in a heating cabinet at a temperature of 80±2°C.	No damage & marking shall be legible.
12.	Ball pressure test	A ball of 5mm in diameter is applied on the connector with the following temperature with 20N force for 1 hour. i) 125°C for hot connectors. ii) 125°C for parts retaining current carrying parts and earth circuit. iii) 75°C for other parts for cold connector. The connector is then cooled down to room temperature with cold water.	The diameter of the impression shall not exceed 2mm.

CONFIDENTIAL PROPERTY OF VOLVEX Information contained herein shall not be disclosed to others, repeated or used for any other purposes except as authorized in writing by an authorized official of Volvex Asia.	
REFERENCE: Volvex (Asia) Pte Ltd	
TITLE: EUROPEAN & BRITISH APPLIANCE COUPLERS	DRAWN: MOLLY 24/02/14
CHECK: <i>[Signature]</i> 26/02/14	APPR: <i>[Signature]</i> 26/2/14
REV: A0	AD

NO.	TEST ITEM	DESCRIPTION	ACCEPTANCE CRITERIA
1.	Moisture resistance test	Samples are kept in a humidity cabinet containing air with a relative humidity between 91 to 95% and a temperature of 20°C-30°C for a duration of 48 hours.	No damage
2.	Electric strength test	Volages of 3000V±60V and 1500V±60V, with min. trip current of 100mA is applied for 60s±5s between current-carrying contacts and body and between each contacts respectively after the moisture resistance tests.	No flashover and breakdown
3.	Insulation resistance test	This test is measured with a D.C 500V after the moisture resistance test. Readings are taken after 60s ± 5s of application of voltage.	Min. 5 M Ohm
4.	Withdrawal force test	i) Min. 1.5N (2N for 16A) - A single pin made to the minimum dimension is inserted into the connector. The pin, together with the weight should exert a force of 1.5N (2N for 16A connector). Each individual pole of the connector is tested separately. ii) Max. 50N (60N for 16A) - Insert and withdraw the connector from a socket having pin dimension to the maximum and shroud dimension to the minimum for 10 times. The connector is then inserted again into the socket hang with a total weight of 50N(60N for 16A). The weight consist of a principal weight which is 90% of the total weight and a supplementary weight of 10%. The test is repeated for hot connector with temperature of 120°C±2°C on the pins.	i) The pin with the weight should not be withdrawn from the connector for more than 3 seconds. ii) The connector shall be withdrawn from the socket. If not the supplementary weight is lifted from a height of 5cm and drop. The connector must be withdrawn. The test is repeated after temperature rise test.

3.3. CHARACTERISTICS

The connector construction shall comply with our catalogue No: VACC5, APC5A, APC5S, APC5M, VAC5AR, APC5SM, DLC5A3, VI625, VI625A, VAG19, VAG17S, VSCC13, AVLIC13, APC13, VSC19, VI625LA, VAG19A, VSCC15, APC5SP, APC13F, VI625BS, APC13G, VAG13A, VAG13S, PIC17S, VIC13A, DLC5U3, VAG13KS, SOC5S, VI625H, VAG19KS, DLC5E3, HPG13A, VI625AT, VAG17A, APC5SF, VCC13, VCC5S, APC13H, VCC17S, VAG19H, APC13FH, APC13HC & VAC17KS "All connectors complying to Standard Sheet C5, C13, C15, C15A, C17 and C19"

3.2. CONSTRUCTION

The connector shall be in accordance with IEC 60320-1 or EN 60320-1, Test specification - appliance couplers.

3.1. SCOPE

REV	DESCRIPTION	DATE
AP	CHANGE TEST RESULT TO 'ACCEPTANCE CRITERIA'	11/03/14
AD	ADD IN CATALOGUE NO. VAC17KS	24/02/14

3. CONNECTOR

CONFIDENTIAL PROPERTY OF VOLEX. Information contained herein shall not be disclosed to others, reproduced or used for any other purposes except as authorized in writing by an authorized official of Volex Asia.	
REFERENCE: Volex (Asia) Pte Ltd	
DRAWN: MOLLY 24/02/14	CHECK: <i>[Signature]</i> 24/02/14
APPR: <i>[Signature]</i> 24/2/14	REV: AQ
TITLE: EUROPEAN & BRITISH APPLIANCE COUPLERS	

NO.	TEST ITEM	DESCRIPTION	ACCEPTANCE CRITERIA
5.	Glow wire test	Glow wire is applied for 30s with temperature of 750°C on inserts and housings retaining contacts and 650°C on elsewhere.	Flame (if any) shall be self-extinguished within 30s upon the removal of the glow wire and molten droplets shall not ignite paper.
6.	Bending test	The sample shall be loaded with a weight of 10N for 0.75mm ² or 20N for 1.00mm ² or bigger and the oscillating member shall be moved backward and forward through an angle of 90°(45° on either side of the vertical) the number of flexing being 20,000. A rated current is applied. For round cord, the sample is turned 90 degree around the axis of cable after 10,000 cycles. The flexing is further completed in this axis. Flat cable is flexed only along the bigger axis of the cable.	There shall be no complete breakage of any of the conductor. Broken conductor shall not have pierced the insulation.
7.	Tumbling test	The sample is dropped from a height of 50cm onto a steel plate(3mm thick) for a total of 500 times.	No damage to impart further use of connector.
8.	Breaking capacity test	The connector is connected and disconnected 50 times (100 strokes) with the inlet at a rate of 30 strokes per minute with 275V and 1.25 times of rated current.	No flashover or sustained arcing during the test and no damage to impart further use of connector.
9.	Normal operation test	Test is similar to breaking capacity except that the test voltage is 250V with the connector connected and disconnected with the inlet for 1000 times (2000 strokes) with rated current and 3000 times (6000 strokes) without current.	Withstand electric strength at 1500V for 1 min, and show no damage.
10.	Temperature rise test	An alternating current at 1.25 times rated current is passed through the current carrying contacts for 1 hour. This is repeated for connector with earth contact passing current between earth and each of the current carrying contacts.	The temperature rise shall not exceed 45K.
11.	Cord-anchorage test	The cord is subjected to pulls of 50N(2.5A) or 60N(others) for 100 times each time for 1 sec. without jerk. Thereafter the cord is subjected for 1 min. to a torque of 0.15Nm(0.75mm ²) or 0.25Nm(others).	The cord shall not be damaged and shall not be displaced by more than 2mm.
12.	Heat deformation test	Samples are kept for 1 hour in a heating cabinet at temperature of 100±2°C.	No damage to impart further use of connector.
13.	Heat pressure test	A pressure of 20N is applied at a temperature of 100°C ± 2°C for 1 hour.	No damage to impart further use of connector.

Confidential property of Voilex. Information contained herein shall not be disclosed to others. reproduced or used for any other purposes except as authorized in writing by an authorized official of voilex asia.	
REFERENCE: Voilex (Asia) Pte Ltd	
TITLE: EUROPEAN & BRITISH APPLIANCE COUPLERS	DRAWN: MOLLY 24/02/14
CHECK: <i>hony</i> 24/02/14	APPR: <i>hony</i> 24/2/14
REV:	AD

NO.	TEST ITEM	DESCRIPTION	ACCEPTANCE CRITERIA
14.	Ageing test	The samples are kept for 168 hours in a heating cabinet at a temperature of $80 \pm 2^\circ\text{C}$.	No damage & marking shall be legible.
15.	Ball pressure test	A ball of 5mm in diameter is applied on the connector with the following temperature with 20N force for 1 hour. (i) 125°C for hot connectors. (ii) 125°C for parts retaining current carrying parts and earth circuit. (iii) 75°C for other parts for cold connector. The connector is then cooled down to room temperature with cold water.	The diameter of the impression shall not exceed 2mm.

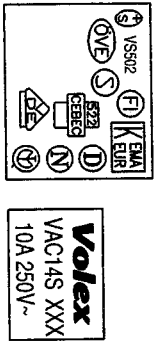
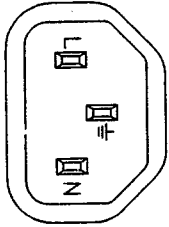
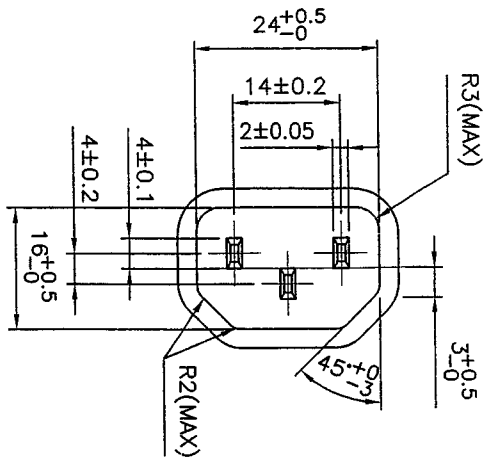

MARKING DETAILS :

- NOTES :**
- 1.) ALL DIMENSIONS IN mm.
 - 2.) X - CAVITY NO. (OPTIONAL)
 - 3.) XXX - MANUFACTURING LOCATION.

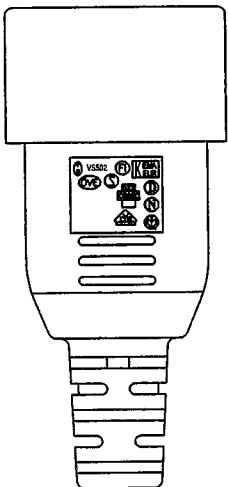
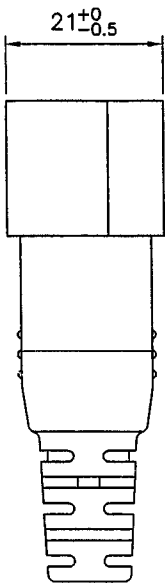
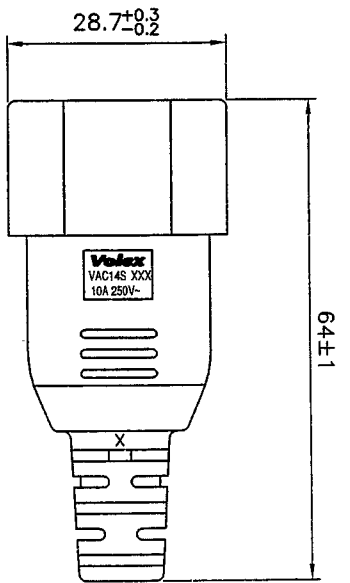

REV.	DESCRIPTION	DATE
G	UPDATE FORMAT AS SHOWN.	03/11/06
G	REMOVE THE CLOSED FACTORY FM. MANU. LOC. MARK.	
H	REMOVE THE CLOSED FACTORY FROM MANU. LOCATION MARK.	23/07/09

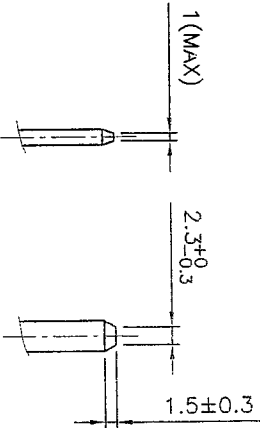
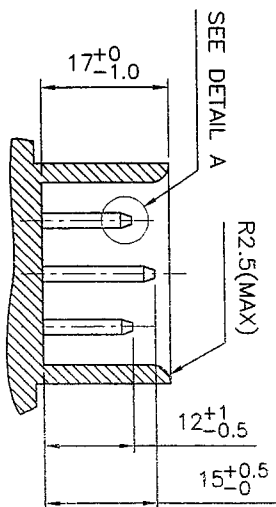

DETAIL A

HG	HENG GANG (CHINA)	X	DRAWN	QIAN SM	23/07/09	FILE NAME :	TITLE :	
SM1	ZHONGSHAN (CHINA)	X	CHECK	homyh	23/07/09	A-CONNECTOR/ EURO/GENERAL/ VAC14S-EURO	MOLDED PLUG CONNECTOR VAC14S	
VH	HANOI (VIETNAM)		APPR	Volux	30/7/9	N.T.S.		
B	BATAM (INDONESIA)		REV.	H	SCALE			
VC	CHENNAI (INDIA)	X	REFERENCE :	EUROPEAN APPROVAL				
MANUFACTURE LOCATION MARK ('X' IS APPLICABLE ONLY)								<p>Information contained herein shall not be disclosed to others, reproduced or used for any other purposes except as authorized in writing by an authorized official of Volux Asia.</p> <p>Confidential Property of Volux.</p> <p>Volux (Asia) Pte Ltd</p>

REV.	DESCRIPTION	DATE
J	UPDATE FORMAT AS SHOWN. REMOVE THE CLOSED FACTORY FM. MANU. LOC. MARK.	02/11/06
K	REMOVE THE CLOSED FACTORY FROM MANU. LOCATION MARK.	23/07/09

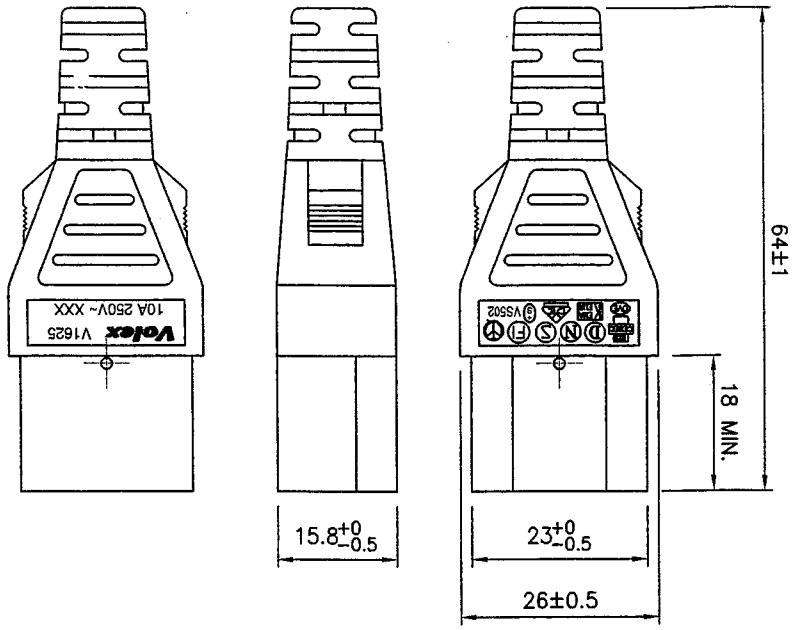
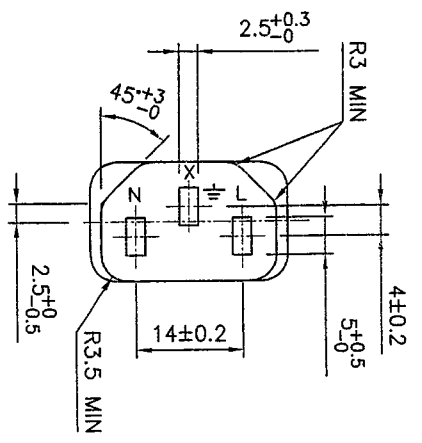

Vollex V1625
10A 250V~XXX

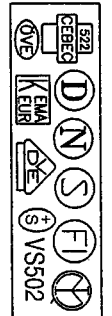

MARKING DETAILS

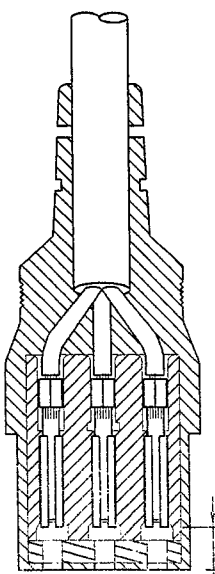

HG	HENG GANG (CHINA)	X	DRAWN	QIAN SW	23/07/09	FILE NAME :	TITLE :
SM1	ZHONGSHAN (CHINA)	X	CHECK	heng	23/07/09	A CONN/EURO/ GENERAL/V1625-	MOLDED CONNECTOR
VH	HANOI (VIETNAM)	X	APPR	Wang	30/7/9	EUROPEAN	V1625
B	BATAM (INDONESIA)	X	REV.	K		N.I.S.	
VC	CHEENNA (INDIA)	X	REFERENCE :				
MANUFACTURE LOCATION MARK (' X ' IS APPLICABLE ONLY)			EUROPEAN APPROVAL		<p>Confidential property of Vollex. Information contained herein shall not be disclosed to others, reproduced or used for any other purposes except as authorized in writing by an authorized official of Vollex Asia.</p>		

- NOTES :**
- 1.) ALL DIMENSIONS IN mm.
 - 2.) X -- CAVITY NO. (OPTIONAL)
 - 3.) XXX -- MANUFACTURING LOCATION

X-ON Electronics

Largest Supplier of Electrical and Electronic Components

Click to view similar products for [volex manufacturer](#):

Other Similar products are found below :

[6491](#) [17419](#) [VQSFPQ30YP100](#) [17751-BLK-C3](#) [17519-BLK-B1](#) [17537-BLK-B1](#) [17537 10 B1](#) [2145H 10 H50](#) [17519 10 B1](#) [VSFP30YP050](#)
[8490-10](#) [17205-10-B1](#) [17621 10 B1](#) [2111H](#) [17660 10 C3](#) [17660-BLK-C3](#) [17251](#) [17612-BLK-B1](#) [17962-BLK-C3](#) [17268A 10 B1](#) [X-](#)
[150708A](#) [17962 10 C3](#) [9415-10-15](#) [17447-10-S2](#) [VL-0836-14-300](#) [2116H 10 C3](#) [17504A 10 B1](#) [17501-BLK-C3](#) [17970 8](#) [17238 10 B1](#)
[17238-BLK-B1](#) [17746 10 B1](#) [17600 10 C3](#) [40230 8](#) [17625 10 B1](#) [17615-10-C3](#) [17968 8](#) [17515](#) [17425-10-S2](#) [17425-BLK-S2](#) [17020A 8 S2](#)
[17508A 10 B1](#) [6482](#) [17523](#) [6483](#) [6479](#) [17635 10 S2](#) [17635-BLK-S2](#) [17510A 8 B1](#) [17510A-GRY-B1](#)