

# Integral Safety Hinge Switch

Tamperproof  
Reliable operation  
Economic installation

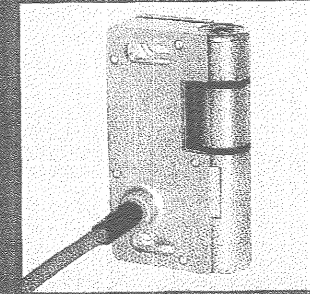
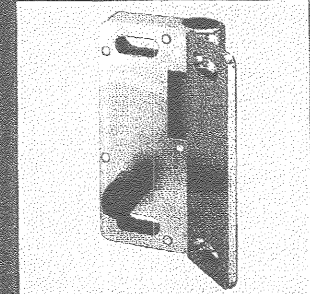
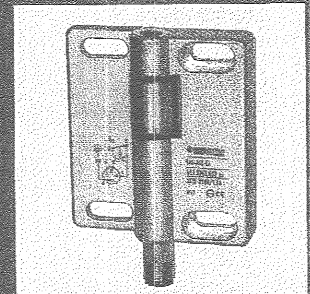

## ...more safety solutions

### Safety switches with separate actuator

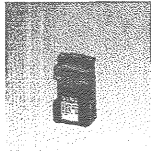

#### Type SKC/SK

- Plastic housing
- Built-in catch option
- IEC 947-5-1
- GS-ET-15
- IP 65

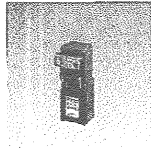

#### Type SKT

- Plastic housing
- 4x90° head rotation
- Short body
- IP 65

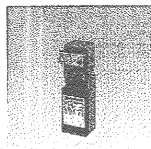

#### Type SKI

- Plastic housing
- 4x90° head rotation
- Mounting to EN 50047
- IP 65

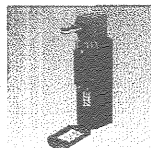

#### Type SLK

- Slim-line plastic housing
- Spring or solenoid locking
- 2000 N holding force
- 4x90° head rotation
- IP 67

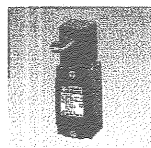

#### Type ENM Type GC

- Metal housing
- Mounting to EN 50041
- IP 65

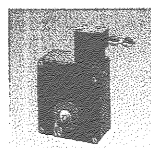

#### Type SLM

- Robust metal housing
- Spring or solenoid locking
- Mounting to EN 50041
- IP 67

### Safety switches for hinged guard applications

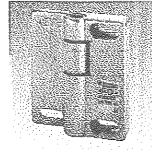

#### Safety Hinge Switch Type SHS

- Metal housing
- Integration of safety switch with load bearing hinge
- Full 180° angle of operation
- 180° programmable switching position
- IP 67

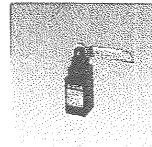

#### Type I 88 VKS/VKW

- Plastic housing
- Suitable for hinged covers and doors
- IP 65

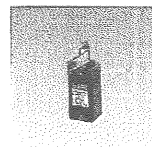

#### Type GC-VKS/VKW

- Metal housing
- Suitable for hinged covers and doors
- IP 65

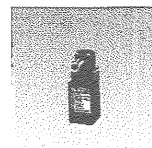

#### Type I 88-AH1/B

- Plastic housing
- Mounting on hinge axis
- IP 65

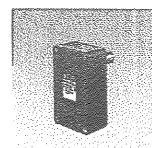

#### Type BCM

- Metal housing
- Mounting on hinge axis
- IP 65

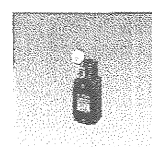

#### Type ENM-AH2

- Metal housing
- Forced disconnect contact in forward and reverse travel
- IP 65

### Other Safety Devices

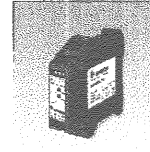

#### Safety Control Relay Type SCR

- Safety category 3 or 4 to EN 954-1
- Monitored manual or automatic re-start
- Up to 4 safety outputs
- EDM function
- Delayed output version

### Safety Rope Switches



#### Safety Rope Switch Type S/Si

- Plastic or metal housing
- Contact latch to EN 418
- IP 65

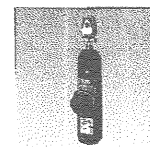

#### Safety Rope Switch Type SR

- Slim-line plastic housing
- EMERGENCY STOP function to EN 60947-5-5
- Integral EMERGENCY STOP button
- Easy installation & set-up
- IP 67

### Safety Magnetic System

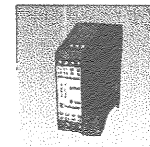

#### Safety Control Unit

- 2 Channel input (1NO/1NC)
- 2 Safety output (NO)
- Galvanically separated data output
- External device monitoring function (EDM)

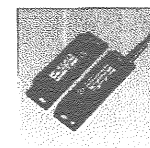

#### Coded Magnetic Switches

- Non-contact switching
- 3 stage coding, guards against manipulation
- IP 67
- Cable or connector types

[www.bernstein-ag.de](http://www.bernstein-ag.de)

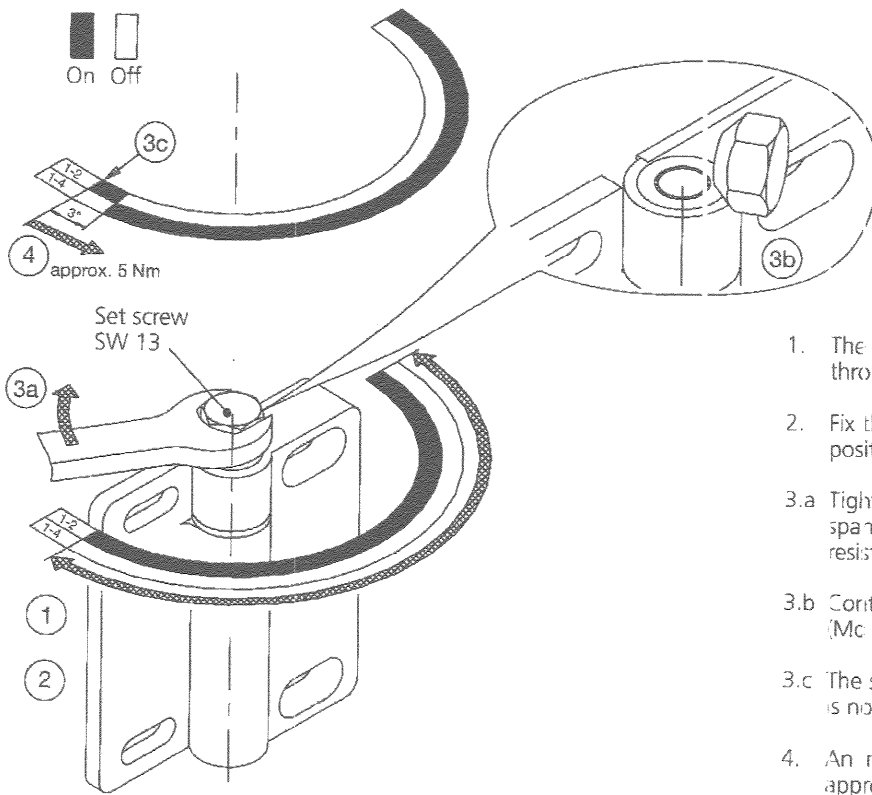

1. The guard door must turn freely through the total operating range.
2. Fix the guard door in the closed position.
- 3.a Tighten the set screw with a box spanner (SW13/max.  $\varnothing$  20 mm) until resistance is met.
- 3.b Continue until the set screw shears. ( $M_c = 25 \text{ Nm}$ )
- 3.c The set point for the switching angle is now fixed.
4. An increased actuation force (torque approx. 5 Nm) is required during the first use of the guard.



The hexagonal head of the set screw must always be sheared off. The safe actuation of the switch will otherwise not be achieved!

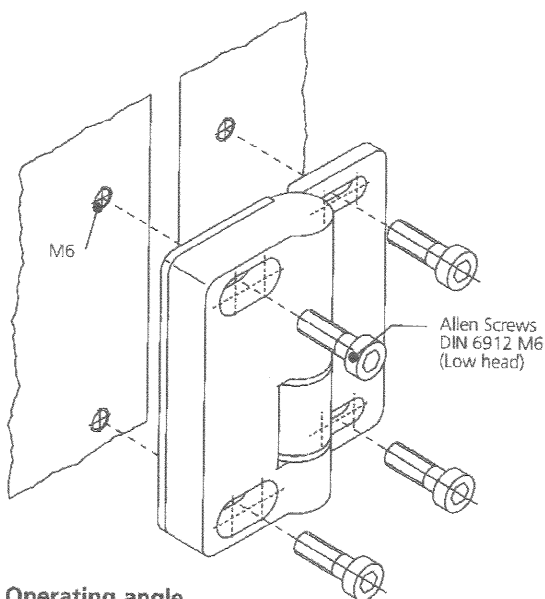

**Operating angle**

0°– 30° = Allen Screw DIN 6912 necessary without washer in the hinge wing

30°–180° = Allen Screw DIN 912 permissible washer DIN 125 in the hinge wing

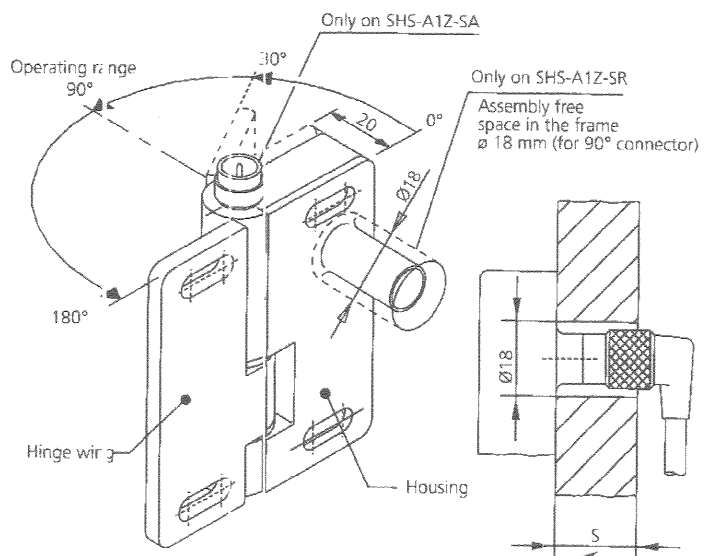

Check wall strength at the attachment position

## Safety Hinge Switch

### SHS

Metal body IP 67

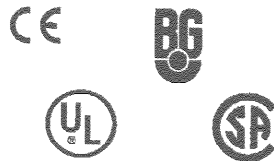

(in preparation)

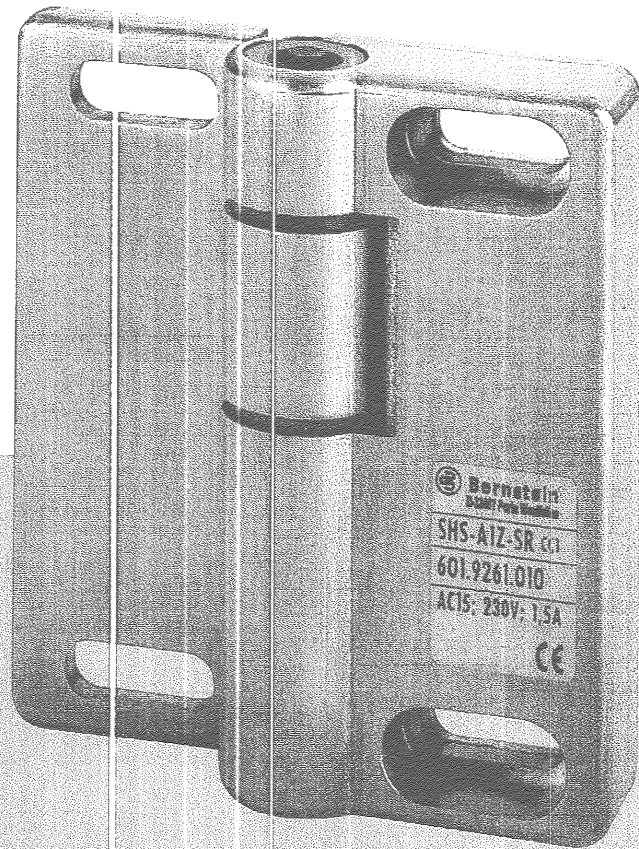

Hinged machinery guards and covers as well as safety fence doors may be found in every type of industry.

**The Safety Hinge Switch SHS is the logical integration of the safety switch and load-bearing hinge for industrial applications.**

Designed to facilitate mounting onto extruded aluminium profiles, steel or plastic doors, the slim profile of the SHS even when fully closed, allows the hinge to be readily mounted where space is constrained.

Traditional safety switches with separate actuator keys are often subject to mechanical wear, particularly when mounted on the closing edges of guards where accumulated tolerances can cause misalignment. The SHS removes this problem with the safety contact mounted internally, inaccessible to the user and therefore providing excellent tamper protection.

One or more switches may be used dependent on the category of safety protection required. Matching hinges without safety contacts are also available, allowing the style to be standardised for general use. In operation, consideration must simply be given to the required contact operation angle, which is determined by guard size and the maximum allowable guard opening distance before actuation.

#### Safe

- Two SHS hinge switches each with a forced disconnect safety contact support safety category 4 systems to be configured subject to the required risk analysis and safety contact monitoring

#### Flexible

- The hinge operating angle is 0–180°
- The switch point may similarly be selected through 180°
- AC/DC to 250 V or 60 V DC versions available

#### Fast

- Industry standard M12 connectors with axial or radial (rear) mounting available as well as a fixed cable version

#### Reliable

- A diecast Zinc alloy body allows the SHS a high degree of mounting freedom
- In its hinge capacity the SHS can bear up to 750 N axially and over 1000 N radially
- Protection class to IP 67

#### SHS configuration summary

##### With M12 x 1 connector, for 60 V DC applications, without earth connection

SHS-A1Z-SR	DC	601.9261.010	BERNSTEIN-Typ	Radial	Plug	ex-stock
------------	----	--------------	---------------	--------	------	----------

##### With M12 x 1 connector, for AC/DC applications to 250 V, with earth connection

SHS-A1Z-SA	AC/DC	601.9261.009	BERNSTEIN-Typ	Axial	Plug	ex-stock
------------	-------	--------------	---------------	-------	------	----------

SHS-A1Z-SR	AC/DC	601.9261.016	BERNSTEIN-Typ	Radial	Plug	ex-stock
------------	-------	--------------	---------------	--------	------	----------

SHS-A1Z-K	AC/DC	601.9261.014	BERNSTEIN-Typ	Fixed	cable, 5-m	to order
-----------	-------	--------------	---------------	-------	------------	----------

##### Hinge without safety contact

SHS-OZ		601.9291.013	BERNSTEIN-Typ	No connection		ex-stock
--------	--	--------------	---------------	---------------	--	----------

### True Category 4 (EN 954-1/2)

Installation example:

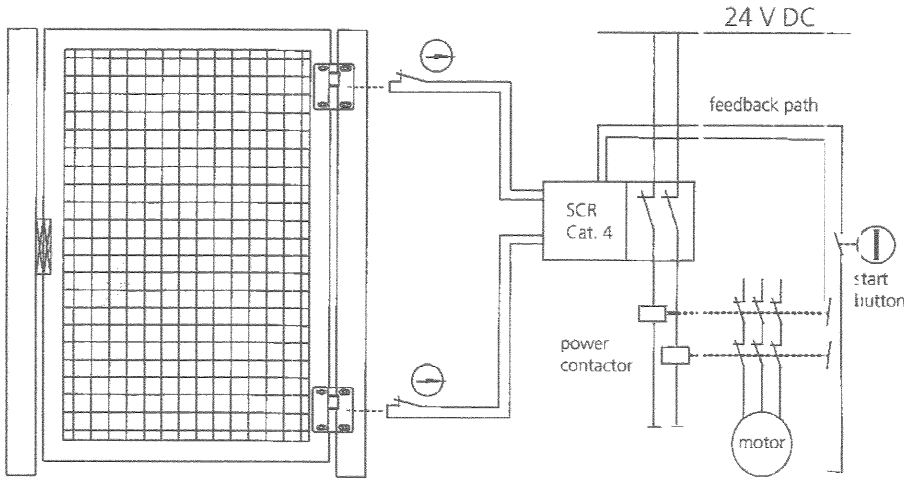

- true electrical redundancy
- true mechanical redundant safety
- avoids mechanical common mode failure

### Safety Hinge Switch

#### SHS

Type  
**Part number**  
 Contact diagram  
 ⊕ Forced disconnect to IEC 947-5-1 annex k  
 Za: non-galv. separated contact  
 Zb: galv. separated contact  
 Slow make and break/Snap action  
 Sealed internally (iw)/externally (w)

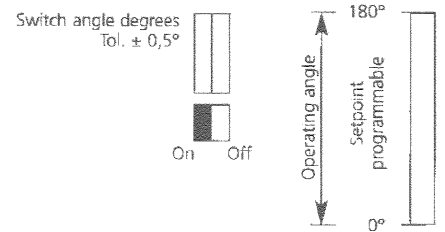

### Plug M 12 x 1 with lock nut

with moulded cable

#### Terminal code

- 1 = brown
- 2 = -
- 3 = blue
- 4 = black

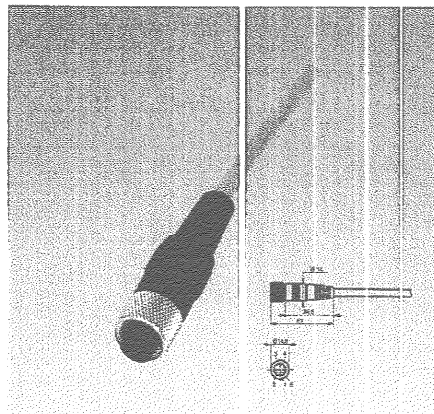
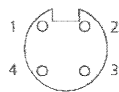

Voltage max.  
 Thermal current max.  
 Switch on current per IEC 947-5-1 AC 15/DC 13

Switching frequency max.  
 Mechanical life – switching operations  
 Operating temperature min./max.

Approvals  
 Approvals pending  
 Weight  
 Ex-stock/to order

All dimensions in mm

Cable length 2 m	Model description <b>Part number</b>	AN-KAB SHS 2M DC GERADE <b>325.1003.221</b>
Cable length 5 m	Model description <b>Part number</b>	AN-KAB SHS 5M DC GERADE <b>325.1003.222</b>
Cable length 10 m	Model description <b>Part number</b>	AN-KAB SHS 10M DC GERADE <b>325.1003.223</b>
Material of cable sleeve		PVC
Material body/Contact carrier		PUR
Operating voltage	max.	60 V AC/75 V DC
Current carrying capacity	max.	1.5 A
Temperature range	min./max.	-25 °C/+70 °C -13 °F/+158 °F
Cable structure	mm <sup>2</sup>	3 x 0.34
Protection class after installation		IP 67

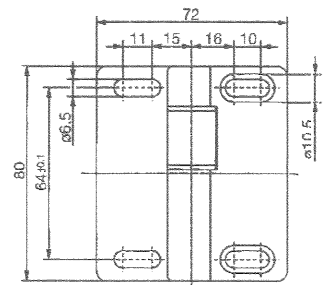

Other plug styles (e.g. rectangular and AC versions) available upon request:

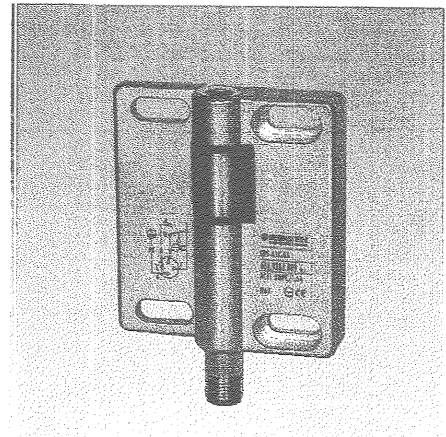
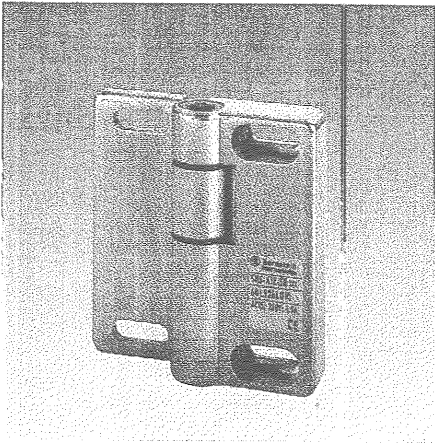

SHS-A1Z-SR  
601.9261.010

SHS-A1Z-SR  
601.9261.016

SHS-A1Z-KR 5  
601.9261.014

SHS-A1Z-SA  
601.9261.009

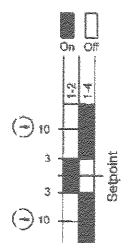
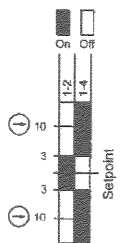
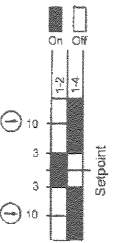
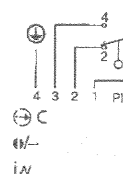
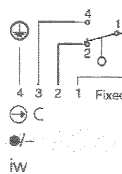
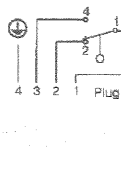
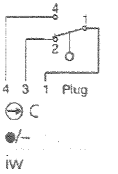

250 VAC  
3 A  
60 V/0.5 A  
(DC 13)  
1200/h  
1 x 10<sup>6</sup>  
-25 °C/+70 °C  
-13 °F/+158 °F

250 VAC  
3 A  
60 V/0.5 A  
(DC 13)  
1200/h  
1 x 10<sup>6</sup>  
-25 °C/+70 °C  
-13 °F/+158 °F

230 V/1.5 A  
(AC 15)

250 VAC  
3 A  
60 V/0.5 A  
(DC 13)  
1200/h  
1 x 10<sup>6</sup>  
-25 °C/+70 °C  
-13 °F/+158 °F

230 V/1.5 A  
(AC 15)

250 VAC  
3 A  
60 V/0.5 A  
(DC 13)  
1200/h  
1 x 10<sup>6</sup>  
-25 °C/+70 °C  
-13 °F/+158 °F

230 V/1.5 A  
(AC 15)

BG, UL, CSA  
0.4 kg

BG, UL, CSA  
0.4 kg

BG, UL, CSA  
0.4 kg

BG, UL, CSA  
0.4 kg

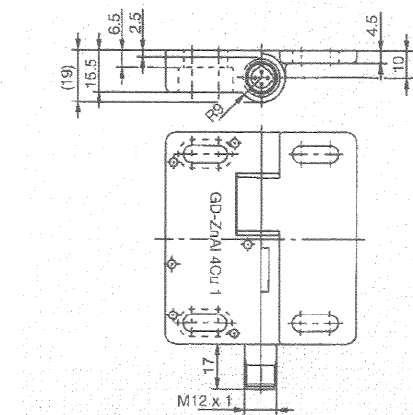
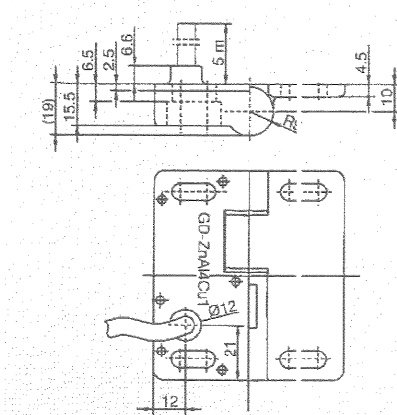
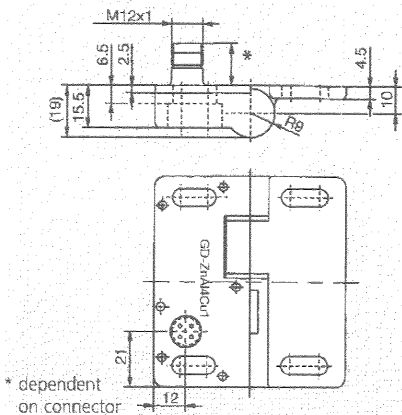

## X-ON Electronics

Largest Supplier of Electrical and Electronic Components

*Click to view similar products for [bernstein](#) manufacturer:*

Other Similar products are found below :

[618.6800.468](#) [9-205](#) [9-205 ESD](#) [1-909](#) [2230](#) [5-079-13](#) [3-245-13](#) [3-656-15](#) [3-688-15](#) [3-960](#) [5-053](#) [6750](#) [CT-722](#) [3-682-15](#) [2280](#) [7015](#) [C2-SU1ZR](#) [9-261](#) [CA-310](#) [CT-682T](#) [CT-822T](#) [CT-882](#) [9-252](#) [616.1500.725](#) [616.1500.726](#) [616.1500.723](#) [5-077-13](#) [ENM2-U1 AD](#) [IN65-SU1Z RK](#) [IN65-U1Z RK](#) [GC-UV1Z RIW](#) [IN65-SU1Z DGHK](#) [I81-U1Z AHK](#) [IN65-SU1Z DGKK](#) [IN65-SU1 AHDM](#) [ENM2-SU1 AD](#) [TI2-SU1 FF](#) [I49-U1Z AH](#) [I49-SU1Z RIW](#) [I49-SU1Z AH](#) [1500](#) [3-672-15](#) [4-920](#) [3-668-15](#) [3-689-15](#) [5-090V](#) [5-190 V](#) [1-150](#) [CA-150](#) [CA-400 UKF](#)