

Features

Plug-in mount

10 A General purpose relay

- 2 & 3 pole changeover contacts
- Cadmium Free contacts (preferred version)
- AC coils & DC coils
- UL Listed (certain relay/socket combinations)
- Contact material options
- Lockable test button with mechanical flag indicator (preferred version)
- 90 series sockets, coil EMC suppression and timer accessories

60.12



- 2 pole - 10 A power contacts
- 8 pin plug-in

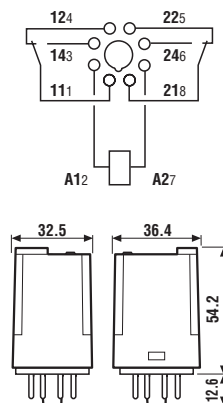

60.13



- 3 pole - 10 A power contacts
- 11 pin plug-in

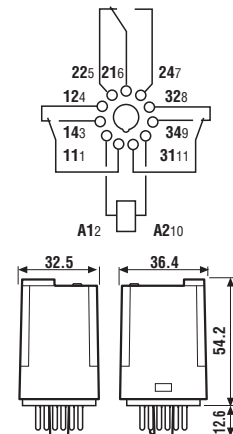

Contact specification

Contact configuration	2 CO (DPDT)	3 CO (3PDT)
Rated current/Maximum peak current A	10/20	10/20
Rated voltage/Maximum switching voltage V AC	250/400	250/400
Rated load AC1 VA	2,500	2,500
Rated load AC15 (230 V AC) VA	500	500
Single phase motor rating (230 V AC) kW	0.37	0.37
Breaking capacity DC1: 30/110/220 V A	10/0.4/0.15	10/0.4/0.15
Minimum switching load mW (V/mA)	500 (10/5)	500 (10/5)
Standard contact material	AgNi	AgNi

Coil specification

Nominal voltage (U _N) V AC (50/60 Hz)	6 - 12 - 24 - 48 - 60 - 110 - 120 - 230 - 240 - 400	
V DC	6 - 12 - 24 - 48 - 60 - 110 - 125 - 220	
Rated power AC/DC VA (50 Hz)/W	2.2/1.3	2.2/1.3
Operating range AC	(0.8...1.1)U _N	(0.8...1.1)U _N
DC	(0.8...1.1)U _N	(0.8...1.1)U _N
Holding voltage AC/DC	0.8 U _N /0.5 U _N	0.8 U _N /0.5 U _N
Must drop-out voltage AC/DC	0.2 U _N /0.1 U _N	0.2 U _N /0.1 U _N

Technical data

Mechanical life AC/DC cycles	20 · 10 ⁶ /50 · 10 ⁶	20 · 10 ⁶ /50 · 10 ⁶
Electrical life at rated load AC1 cycles	200 · 10 ³	200 · 10 ³
Operate/release time ms	9/9	9/9
Insulation between coil and contacts (1.2/50 μs) kV	3.6	3.6
Dielectric strength between open contacts V AC	1,000	1,000
Ambient temperature range °C	-40...+70	-40...+70
Environmental protection	RT I	RT I

Approvals (according to type)



Features

Plug-in mount - 6 A

Bifurcated contacts for low level switching

- 2 & 3 pole changeover contacts
- Cadmium Free contacts (Gold plated Silver Nickel)
- AC coils & DC coils
- Lockable test button with mechanical flag indicator (preferred version)
- 90 series sockets, coil EMC suppression and timer accessories

60.12 - 0200



- 2 pole - 6 A bifurcated contacts
- 8 pin plug-in

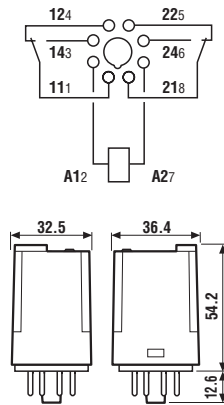

60.13 - 0200



- 3 pole - 6 A bifurcated contacts
- 11 pin plug-in

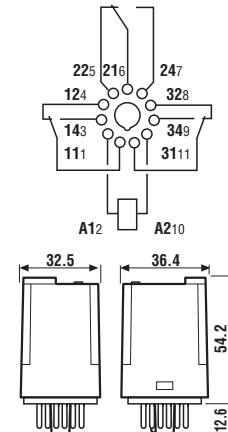

60

Contact specification			
Contact configuration		2 CO (DPDT)	3 CO (3PDT)
Rated current/Maximum peak current	A	6/10	6/10
Rated voltage/Maximum switching voltage	V AC	250/400	250/400
Rated load AC1	VA	1,500	1,500
Rated load AC15 (230 V AC)	VA	250	250
Single phase motor rating (230 V AC)	kW	0.185	0.185
Breaking capacity DC1: 30/110/220 V	A	6/0.3/0.12	6/0.3/0.12
Minimum switching load	mW (V/mA)	50 (5/5)	50 (5/5)
Standard contact material		AgNi + Au bifurcated contacts	AgNi + Au bifurcated contacts
Coil specification			
Nominal voltage (U _N)	V AC (50/60 Hz)	6 - 12 - 24 - 48 - 60 - 110 - 120 - 230 - 240 - 400	
	V DC	6 - 12 - 24 - 48 - 60 - 110 - 125 - 220	
Rated power AC/DC	VA (50 Hz)/W	2.2/1.3	2.2/1.3
Operating range	AC	(0.8...1.1)U _N	(0.8...1.1)U _N
	DC	(0.8...1.1)U _N	(0.8...1.1)U _N
Holding voltage	AC/DC	0.8 U _N /0.5 U _N	0.8 U _N /0.5 U _N
Must drop-out voltage	AC/DC	0.2 U _N /0.1 U _N	0.2 U _N /0.1 U _N
Technical data			
Mechanical life AC/DC	cycles	20 · 10 ⁶ /50 · 10 ⁶	20 · 10 ⁶ /50 · 10 ⁶
Electrical life at rated load AC1	cycles	250 · 10 ³	250 · 10 ³
Operate/release time	ms	9/9	9/9
Insulation between coil and contacts (1.2/50 μs)	kV	3.6	3.6
Dielectric strength between open contacts	V AC	1,000	1,000
Ambient temperature range	°C	-40...+70	-40...+70
Environmental protection		RT I	RT I

Approvals (according to type)



Features

Flange mount 10 A General purpose relay

- Flange mount (Faston 187, 4.8x0.8 mm termination)
- 2 & 3 pole changeover contacts
- AC coils & DC coils
- Cadmium Free contacts (preferred version)
- Contacts material options

60.62



- 2 pole - 10 A power contacts
- Flange mount/Faston 187

60.63



- 3 pole - 10 A power contacts
- Flange mount/Faston 187

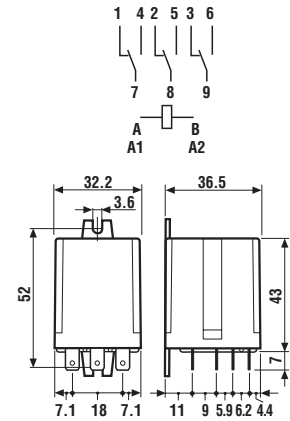
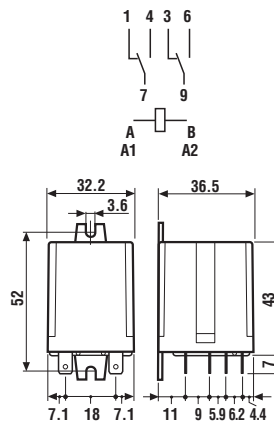

Contact specification

Contact configuration	2 CO (DPDT)	3 CO (3PDT)
Rated current/Maximum peak current A	10/20	10/20
Rated voltage/Maximum switching voltage V AC	250/400	250/400
Rated load AC1 VA	2,500	2,500
Rated load AC15 (230 V AC) VA	500	500
Single phase motor rating (230 V AC) kW	0.37	0.37
Breaking capacity DC1: 30/110/220 V A	10/0.4/0.15	10/0.4/0.15
Minimum switching load mW (V/mA)	500 (10/5)	500 (10/5)
Standard contact material	AgNi	AgNi

Coil specification

Nominal voltage (U _N) V AC (50/60 Hz)	6 - 12 - 24 - 48 - 60 - 110 - 120 - 230 - 240 - 400	
V DC	6 - 12 - 24 - 48 - 60 - 110 - 125 - 220	
Rated power AC/DC VA (50 Hz)/W	2.2/1.3	2.2/1.3
Operating range AC	(0.8...1.1)U _N	
	(0.8...1.1)U _N	
Holding voltage AC/DC	0.8 U _N /0.5 U _N	
	0.2 U _N /0.1 U _N	

Technical data

Mechanical life AC/DC cycles	20 · 10 ⁶ /50 · 10 ⁶	20 · 10 ⁶ /50 · 10 ⁶
Electrical life at rated load AC1 cycles	200 · 10 ³	200 · 10 ³
Operate/release time ms	9/9	9/9
Insulation between coil and contacts (1.2/50 μs) kV	3.6	3.6
Dielectric strength between open contacts V AC	1,000	1,000
Ambient temperature range °C	-40...+70	-40...+70
Environmental protection	RT I	RT I

Approvals (according to type)



Ordering information

Example: 60 series plug-in relay, 3 CO (3PDT), 12 V DC coil, test button and mechanical indicator.

60.139.012.0040

Series — 60
Type — 1
 1 = 8/11 pin plug-in
 6 = Faston 187 (4.8x0.8 mm) with flange mount
No. of poles — 3
 2 = 2 pole
 3 = 3 pole
Coil version — 9
 4 = Current sensing
 8 = AC (50/60 Hz)
 9 = DC
Coil voltage — 0
 see coil specifications

A: Contact material
 0 = Standard
 2 = AgCdO
 5 = AgNi + Au (5 μm)
B: Contact circuit
 0 = CO (nPDT)
 2 = Bifurcated contacts
 60.12/13 - 6 A only

C: Options
 0 = None
 2 = Mechanical indicator
 3 = LED (AC)
 4 = Lockable test button + mechanical indicator
 5 = Lockable test button + LED (AC)
 54 = Lockable test button + LED (AC) + mechanical indicator
 6 = LED + diode (DC, polarity positive to pin 2)
 7 = Lockable test button + LED + diode (DC, polarity positive to pin 2)
 74 = Lockable test button + LED + diode (DC, polarity positive to pin 2) + mechanical indicator

Selecting features and options: only combinations in the same row are possible.
 Preferred selections for best availability are shown in **bold**.

Type	Coil version	A	B	C	D
60.12/13	AC	0 - 2	0	0 - 2 - 3 - 4 - 5	0
	AC	0 - 2	0	54	/
	AC	5	0 - 2	0 - 2 - 3 - 4 - 5	0
	AC	5	0 - 2	54	/
	DC	0 - 2	0	0 - 2 - 4 - 6 - 7	0
	DC	0 - 2	0	74	/
	DC	5	0 - 2	0 - 2 - 4 - 6 - 7	0
	DC	5	0 - 2	74	/
	current sensing	0	0	4	0
60.62/63	AC-DC	0 - 2 - 5	0	0	0

Descriptions: Options and Special versions

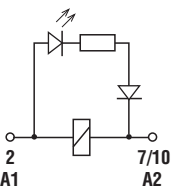

C: Option 3, 5, 54
LED (AC)

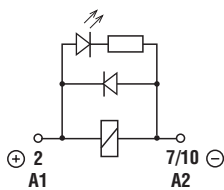

C: Option 6, 7, 74
LED + diode (DC, polarity positive to pin 2)



Lockable test button and mechanical flag indicator (0040)

The dual-purpose Finder test button can be used in two ways:

Case 1) The plastic pip (located directly above the test button) remains intact. In this case, when the test button is pushed, the contacts operate. When the test button is released the contacts return to their former state.

Case 2) The plastic pip is broken-off (using an appropriate cutting tool). In this case, (in addition to the above function), when the test button is pushed and rotated, the contacts are latched in the operating state, and remain so until the test button is rotated back to its former position.

In both cases ensure that the test button actuation is swift and decisive.

Technical data

Insulation					
Insulation according to EN 61810-1 ed. 2	insulation rated voltage	V	250		400
	rated impulse withstand voltage	kV	4 (2 pole)	3.6 (3 pole)	4 (2 pole) 3.6 (3 pole)
	pollution degree		3		2
	overvoltage category		III		III
Insulation between coil and contacts (1.2/50 μs)		kV	3.6		
Dielectric strength between open contacts		V AC	1,000		
Dielectric strength between adjacent contacts		V AC	2,000		
Conducted disturbance immunity					
Burst (5...50)ns, 5 kHz, on A1 - A2			EN 61000-4-4	level 4 (4 kV)	
Surge (1.2/50 μs) on A1 - A2 (differential mode)			EN 61000-4-5	level 4 (4 kV)	
Other data					
Bounce time: NO/NC		ms	2/4		
Vibration resistance (5...55)Hz, max. ± 1 mm: NO/NC		g/g	22/22		
Shock resistance		g	20		
Power lost to the environment			2 pole	3 pole	
		without contact current	W	1.3	
		with rated current	W	2.7 3.4	

60

Contact specification

F 60 - Electrical life (AC) v contact current

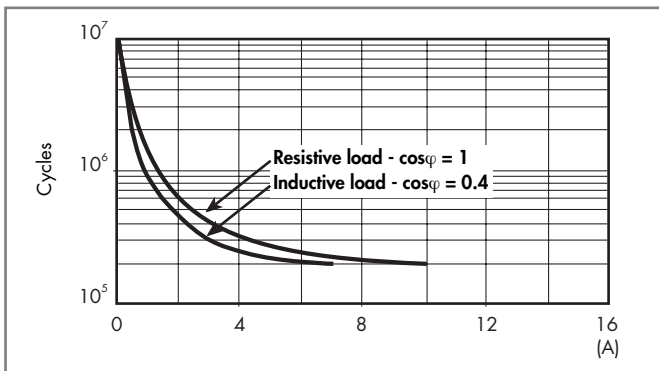

H 60 - Maximum DC1 breaking capacity

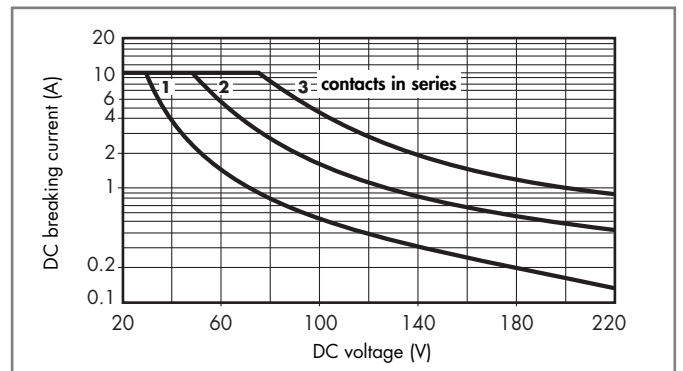

- When switching a resistive load (DC1) having voltage and current values under the curve, an electrical life of $\geq 100 \cdot 10^3$ can be expected.
- In the case of DC13 loads, the connection of a diode in parallel with the load will permit a similar electrical life as for a DC1 load. Note: the release time for the load will be increased.

Coil specifications

DC coil data

Nominal voltage U_N V	Coil code	Operating range		Resistance R Ω	Rated coil consumption I at U_N mA
		U_{min} V	U_{max} V		
6	9.006	4.8	6.6	28	214
12	9.012	9.6	13.2	110	109
24	9.024	19.2	26.4	445	53.9
48	9.048	38.4	52.8	1,770	27.1
60	9.060	48	66	2,760	21.7
110	9.110	88	121	9,420	11.7
125	9.125	100	137.5	12,000	10.4
220	9.220	176	242	37,300	5.8

AC coil data

Nominal voltage U_N V	Coil code	Operating range		Resistance R Ω	Rated coil consumption I at U_N (50Hz) mA
		U_{min} V	U_{max} V		
6	8.006	4.8	6.6	4.6	367
12	8.012	9.6	13.2	19	183
24	8.024	19.2	26.4	74	90
48	8.048	38.4	52.8	290	47
60	8.060	48	66	450	37
110	8.110	88	121	1,600	20
120	8.120	96	132	1,940	18.6
230	8.230	184	253	7,250	10.5
240	8.240	192	264	8,500	9.2
400	8.400	320	440	19,800	6

Coil specifications

R 60 - DC coil operating range v ambient temperature

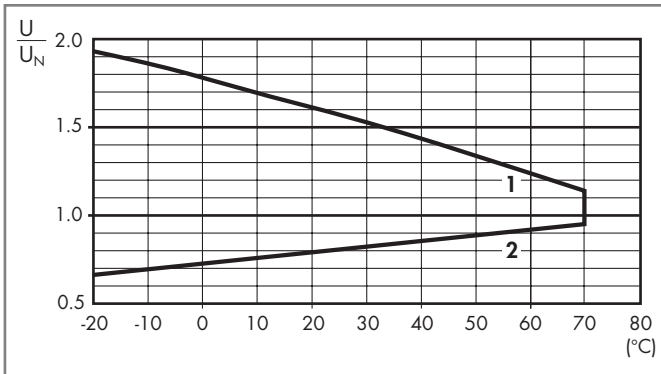

- 1 - Max. permitted coil voltage.
- 2 - Min. pick-up voltage with coil at ambient temperature.

R 60 - AC coil operating range v ambient temperature

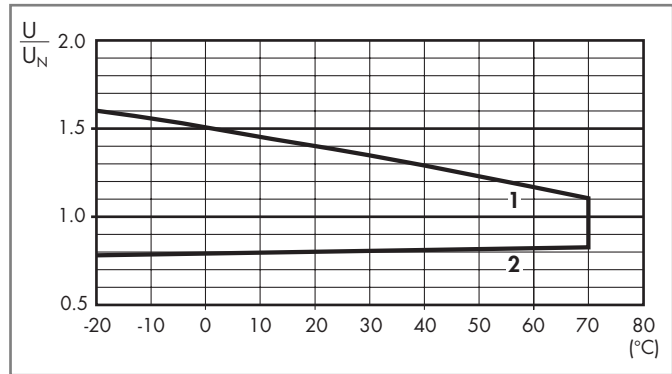

- 1 - Max. permitted coil voltage.
- 2 - Min. pick-up voltage with coil at ambient temperature.

60

Current sensing version

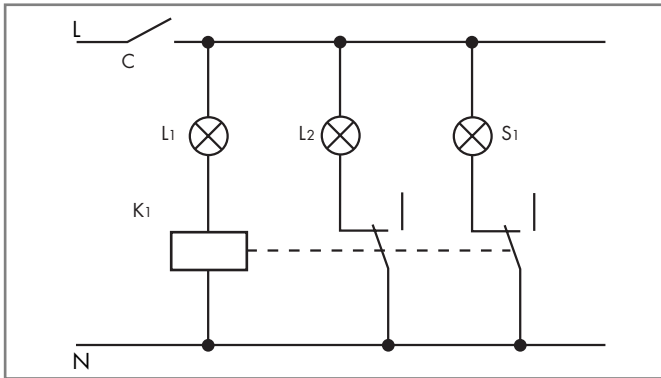

Typical application with current sensing relays.
An open circuit filament of lamp L1 is detected by the current sensing relay coil (K1) which causes the back-up safety lamp L2 to be energised, and indication of failure at the control panel via lamp S1.

Example: navigation light.

- L1 = Light
- L2 = Safety light
- S1 = Control light
- K1 = Relay

Current sensing DC coil data

Coil code	I_{min} (A)	I_N (A)	I_{max} (A)	R (Ω)
4202	1.7	2.0	2.4	0.15
4182	1.5	1.8	2.2	0.19
4162	1.4	1.6	1.9	0.24
4142	1.2	1.4	1.7	0.31
4122	1.0	1.2	1.4	0.42
4102	0.85	1.0	1.2	0.61
4092	0.8	0.9	1.1	0.75
4062	0.5	0.6	0.7	1.70
4032	0.25	0.3	0.4	6.70
4012	0.085	0.1	0.15	61

Current sensing AC coil data

Coil code	I_{min} (A)	I_N (A)	I_{max} (A)	R (Ω)
4251	2.1	2.5	3.0	0.05
4181	1.5	1.8	2.2	0.10
4161	1.4	1.6	1.9	0.12
4121	1.0	1.2	1.4	0.22
4101	0.85	1.0	1.2	0.32
4051	0.42	0.5	0.6	1.28
4041	0.34	0.4	0.5	2.00
4031	0.25	0.3	0.4	3.57
4021	0.17	0.2	0.25	8.0
4011	0.085	0.1	0.15	32.1

Other types of current sensing relays are available on request.

Accessories



060.72

Sheet of marker tags for relay types 60.12 and 60.13, plastic, 72 tags, 6x12 mm

060.72

ORDERING INFORMATION

Example: a 60 series P.C.B. relay, 3 CO (3PDT) with coil rated 12 V DC.

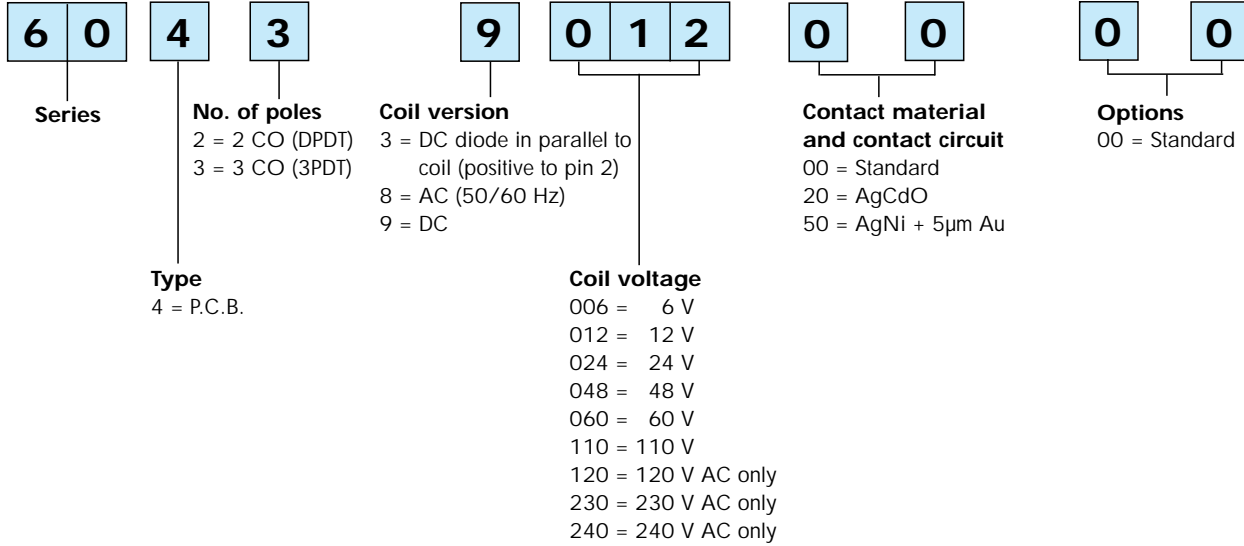

OPTIONS

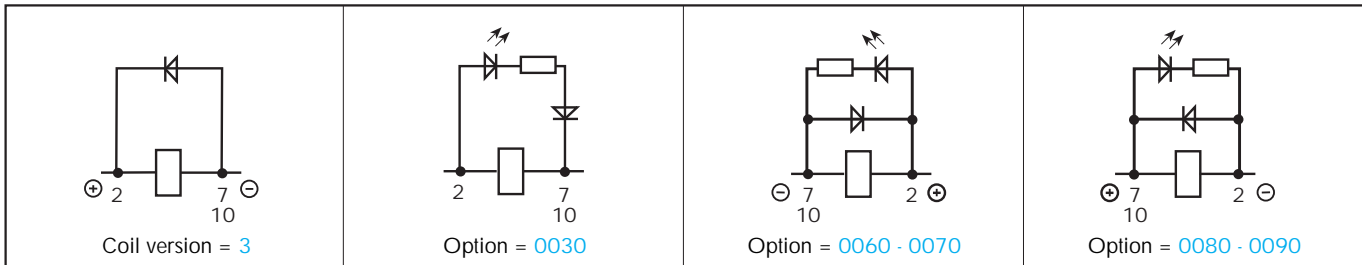



60.43

TECHNICAL DATA

DIELECTRIC STRENGTH tested at leakage current ≤ 10 mA for 1 min at 50 Hz	between coil and contacts	2,000 V
	between open contacts	2,000 V
	between adjacent contacts	1,000 V
	between frame and live parts	2,000 V
SURGE TEST (1.2/50 μs) BETWEEN COIL AND CONTACTS	2,500 V	
ISOLATION RESISTANCE	≥ 20 · 10 ³ MΩ	
ISOLATION GROUP	C 250	
MAXIMUM SWITCHING FREQUENCY	- without load	36,000 cycles/h
	- at rated load	1,800 cycles/h
AMBIENT TEMPERATURE	(-40 ... +70)°C	
MECHANICAL LIFE	20 · 10 ⁶ cycles version AC 50 · 10 ⁶ cycles version DC	
PROTECTION CATEGORY OF ENCLOSURES	IP 40	
OPERATE AND RELEASE TIME		
	- pick-up time (0 to U _N)	≤ 15 ms (including contact bounce)
	- drop-out time (U _N to 0)	≤ 15 ms (including contact bounce)
TYPE OF DUTY	continuous	
DIELECTRIC TEST	2	
TYPE OF RELAY	all-or-nothing	



P.C.B. RELAYS 10 A

TYPE 60.42 2 CO (DPDT)

TYPE 60.43 3 CO (3PDT)

- Tin plated copper pins (1.2 x 0.5 mm)
- Standard contact material: AgNi
- Options: see coding table page 62
- Ordering information: see page 62

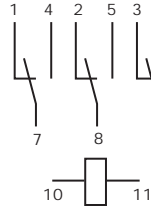
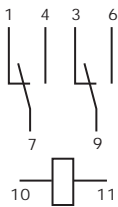
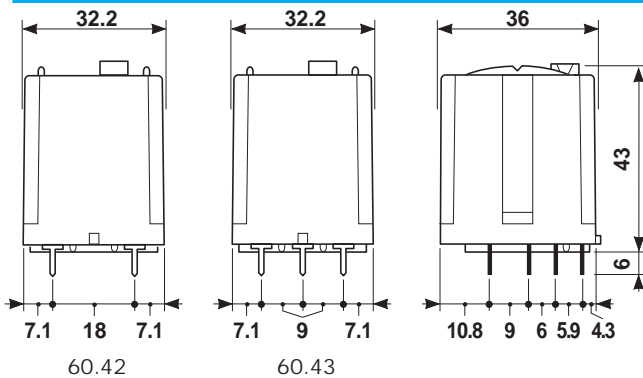

60.42

60.43

copper side view

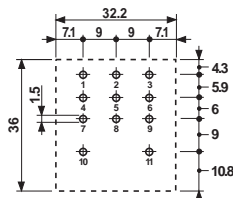
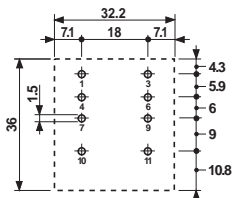

60.42

60.43

CONTACT SPECIFICATIONS

RATED CURRENT	10 A
MAXIMUM PEAK CURRENT	20 A
NOMINAL RATE IN AC1	2,500 VA
NOMINAL RATE IN AC15	500 VA
RATED VOLTAGE	250 V AC
MAXIMUM SWITCHING VOLTAGE	400 V AC
BREAKING CAPACITY IN DC1	see diagram H 60
SINGLE PHASE HP MOTOR RATING	0.37 kW/0.6 HP
CONTACT RESISTANCE: - initial	≤ 50 mΩ
MINIMUM SWITCHING LOAD	500 mW (10 V/5 mA)
STANDARD CONTACT MATERIAL	AgNi

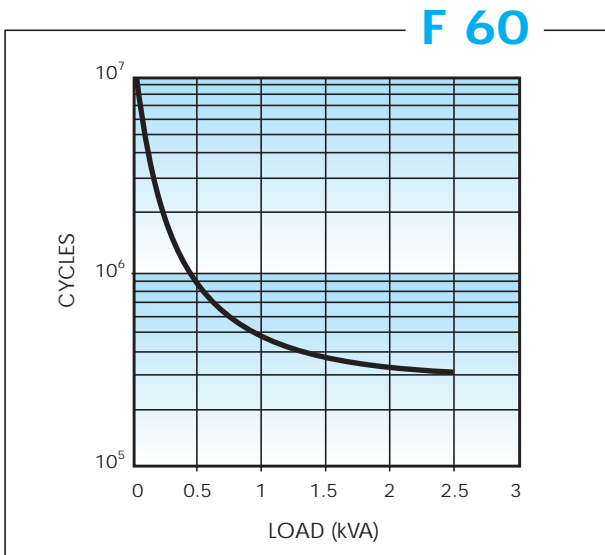

Contact life vs AC1 load at 1800 cycles/h.

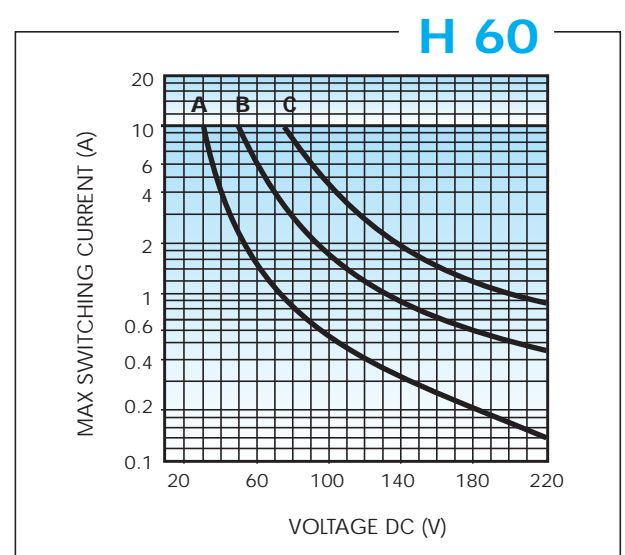

Breaking capacity for DC1 load at 1800 cycles/h.

A = load applied to 1 contact

B = load applied to 2 contacts in series

C = load applied to 3 contacts in series

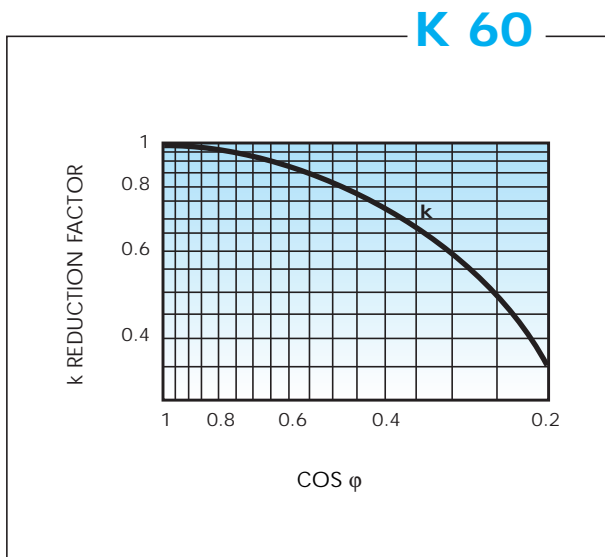

Load reduction factor vs cos φ.

COIL SPECIFICATIONS

VERSIONS:

AC - alternating current 50/60 Hz

DC - direct current

AM - current sensing

DI - DC coil with a diode in parallel

	AC	DC
RATED POWER	2.2 VA	1.3 W
OPERATING RANGE	(0.8 to 1.1) U _N	(0.8 to 1.1) U _N
HOLDING VOLTAGE	≤ 0.8 U _N	≤ 0.5 U _N
MUST DROP-OUT VOLTAGE	≥ 0.2 U _N	≥ 0.1 U _N
NOMINAL MAGNETOMOTIVE FORCE	180 A	250 A
THERMAL INSULATION CLASS OF WIRE	F (+155°C)	F (+155°C)
THERMAL RESISTANCE	43°C/W	43°C/W
CONDUCTED DISTURBANCE IMMUNITY	BURST (acc. to EN 61000 - 4 - 4) level 4 (4 kV) SURGE (acc. to EN 61000 - 4 - 5) level 4 (4 kV)	

AC VERSION DATA

R values relate to +20°C. Tolerance of R and I values: ± 10%.

Rated voltage U _N	Operating range		Resistance R	Nominal coil absorption U _N 50 Hz I
	U _{min}	U _{max}		
V	V	V	Ω	mA
6	4.8	6.6	4.6	367
12	9.6	13.2	19	183
24	19.2	26.4	80	91.7
48	38.4	52.8	320	45.8
60	48	66	500	36.7
110	88	121	1,800	20
120	96	132	1,940	18.6
230	184	253	7,250	9.6
240	192	264	8,500	9.2

DC VERSION DATA

R values relate to +20°C. Tolerance of R and I values: ± 10%.

Rated voltage U _N	Operating range		Resistance R	Nominal coil absorption I
	U _{min}	U _{max}		
V	V	V	Ω	mA
6	4.8	6.6	28	214
12	9.6	13.2	110	109
24	19.2	26.4	445	53.9
48	38.4	52.8	1,770	27.1
60	48	66	2,760	21.7
110	88	121	9,420	11.7

COIL SPECIFICATIONS

R 60

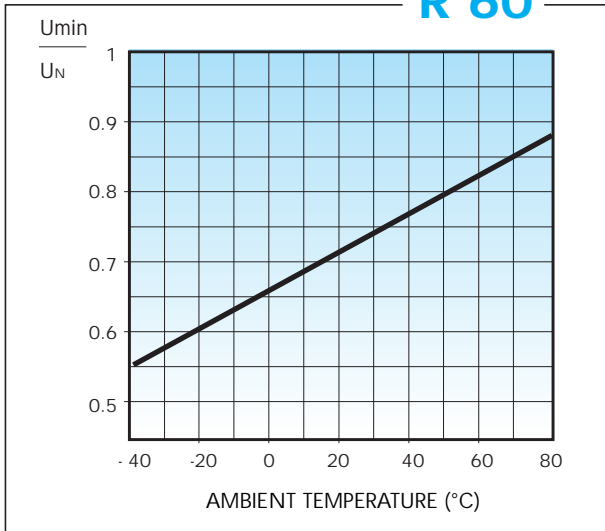

DC coil min pick-up voltage vs ambient temperature.
 U_{min} = pick-up voltage
 U_N = rated voltage

S 60/1

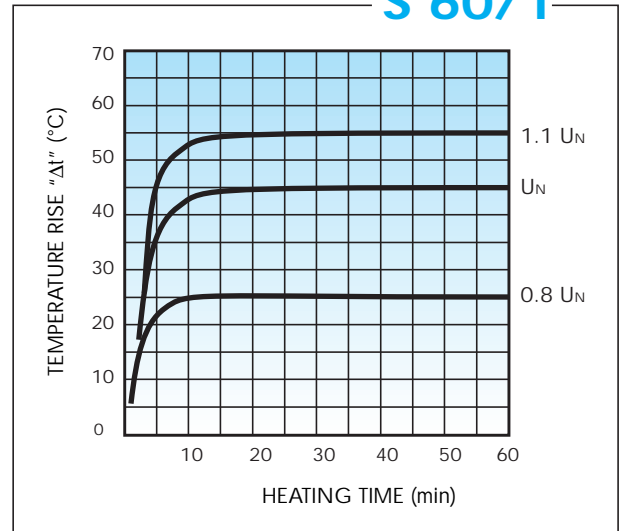

Temperature rise "Δt" vs applied voltage. DC coils.

S 60/2

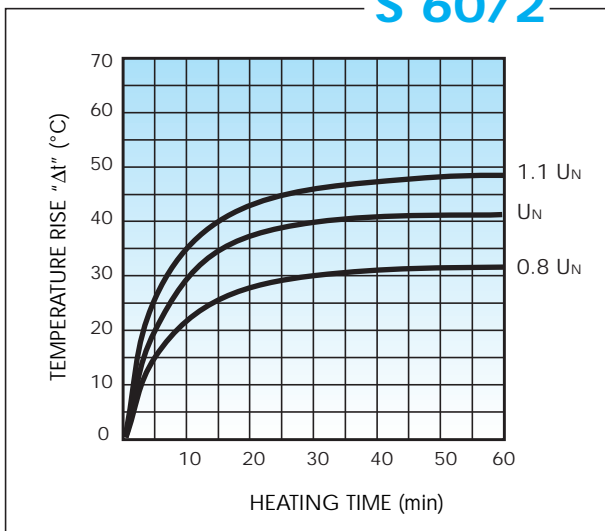

Temperature rise "Δt" vs applied voltage. AC 50 Hz coils.

S 60/3

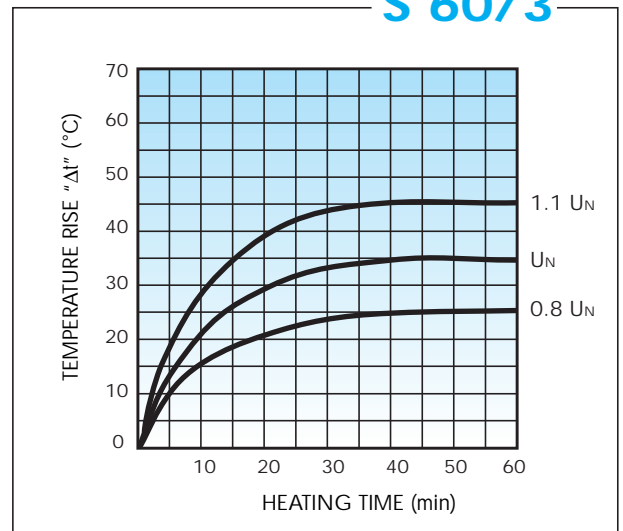

Temperature rise "Δt" vs applied voltage. AC 60 Hz coils.

X-ON Electronics

Largest Supplier of Electrical and Electronic Components

Click to view similar products for [Industrial Relays](#) category:

Click to view products by [Finder](#) manufacturer:

Other Similar products are found below :

[6-1618400-7](#) [686-117111](#) [686-120111](#) [EV250-4A-02](#) [EV250-6A-01](#) [FCA-125-CX8](#) [FCA-410-138](#) [8-1618393-1](#) [GCA32A208VAC60HZ](#)
[GCA32A220VAC50/60HZ](#) [GCA32A230VAC50/60HZ](#) [GCA32A240VAC50/60HZ](#) [GCA32A48VAC60HZ](#) [GCA63A120VAC50/60HZ](#)
[GCA63A208VAC60HZ](#) [GCA63A220VAC60HZ](#) [GCA63A230VAC50/60HZ](#) [GCA63A240VAC50/60HZ](#) [GCA63A277VAC60HZ](#)
[GCA63A48VAC60HZ](#) [GCA63A500VAC50/60HZ](#) [GCA63A600VAC60HZ](#) [GCA800A200VACDC](#) [GCA95A110VAC50/60HZ](#)
[GCA95A120VAC50/60HZ](#) [GCA95A12VDC](#) [GCA95A240VAC50/60HZ](#) [GCA95A24VAC50/60HZ](#) [GCA95A48VAC60HZ](#) [ACC530U20](#)
[ACC730U30](#) [1395832-1](#) [RM699BV-3011-85-1005](#) [RMIA210230AC](#) [RMIA45024AC](#) [1423675-8](#) [B07B032AC1-0329](#) [B329](#) [1617807-1](#)
[N417](#) [P25-E5019-1](#) [P30C42A12D1-120](#) [2-1618398-1](#) [PBO-18A1218](#) [2307497](#) [RPYA00324LT](#) [RPYA003A120LT](#) [KR-4539-1](#)
[RT334012WG](#) [S160156115](#)