

Solid-state Timer H3BF-N/BG-N/BH-N

Please read and understand this catalog before purchasing the products. Please consult your OMRON representative if you have any questions or comments. Refer to *Warranty and Application Considerations* (page 23), and *Safety Precautions* (page 22).

A Wide Variety of DIN 48 x 48-mm Twin Timers, Star-delta Timers, and Power OFF-delay Timers

- CE marking.
UL, CSA and CCC certification, conforms to LR.
- High immunity against waveform distortion of power supply caused by devices like inverters.
- Three-language instruction manual provided.

■ Broad Line-up of H3B□-N Series

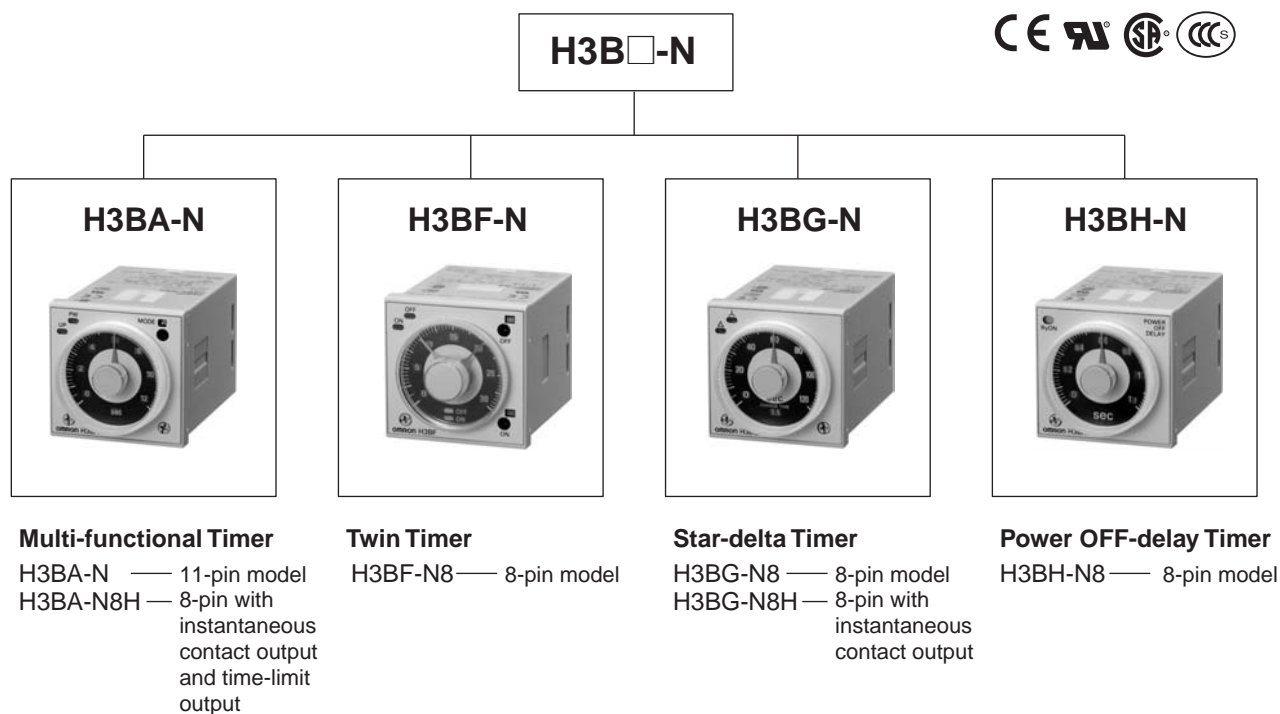

Note: Refer to the H3BA-N Datasheet (Cat. No. L093-E1-03) for details.

Solid-state Twin Timer H3BF-N8

- Independent ON- and OFF-time settings. Furthermore, combinations of long ON- or OFF-time and short OFF- or ON-time settings are possible.
- Wide time ranges from 0.05 s to 300 h.
- Easy sequence checks through instantaneous outputs for a zero set value at any time range.
- Approved by UL, CSA, CE and CCC.



Model Number Structure

■ Model Number Legend

H3BF-N□
1

1. Configuration
8: 8-pin socket

Ordering Information

■ List of Models

Operating modes	Supply voltage	Models
Flicker OFF start	110 VAC (50/60 Hz)	H3BF-N8
	220 VAC (50/60 Hz)	

Note: Specify both the model number and supply voltage when ordering.

Example: H3BF-N8 110 VAC

└── Supply voltage

■ Accessories (Order Separately)

Name/specifications		Models
Flush Mounting Adapters		Y92F-30
		Y92F-73
		Y92F-74
Mounting Tracks	50 cm (l) × 7.3 mm (t)	PFP-50N
	1 m (l) × 7.3 mm (t)	PFP-100N
	1 m (l) × 16 mm (t)	PFP-100N2
End Plate		PFP-M
Spacer		PFP-S
Protective Cover		Y92A-48B
Track Mounting/Front Connecting Socket	8-pin	P2CF-08
Back Connecting Socket	8-pin	P3G-08
Hold-down Clips	For PL08 Socket	Y92H-7
	For PF085A Socket	Y92H-8

Specifications

■ General

Item	H3BF-N8
Operating mode	Flicker OFF start
Pin type	8-pin
Operating/Reset method	Time-limit operation/Time-limit reset or self-reset
Output type	Relay output (DPDT)
Mounting method	DIN track mounting, surface mounting, and flush mounting
Approved standards	UL508, CSA C22.2 No.14, CCC Conforms to EN61812-1 (Pollution degree 2 / Overvoltage category III)

■ Time Ranges

Full scale setting	Time unit	Time unit					
		s (sec)	× 10 s (10 s)	min	× 10 m (10 m)	h (hrs)	× 10 h (10 h)
1.2	Set time	0.05 to 1.2	1.2 to 12	0.12 to 1.2	1.2 to 12	0.12 to 1.2	1.2 to 12
3		0.3 to 3	3 to 30	0.3 to 3	3 to 30	0.3 to 3	3 to 30
12		1.2 to 12	12 to 120	1.2 to 12	12 to 120	1.2 to 12	12 to 120
30		3 to 30	30 to 300	3 to 30	30 to 300	3 to 30	30 to 300

Note: Instantaneous output is available at any time range. To obtain instantaneous output, set to below 0.

■ Ratings

Rated supply voltage	110 VAC (50/60 Hz), 220 VAC (50/60 Hz)
Operating voltage range	85% to 110% of rated supply voltage
Power reset	Minimum power-opening time: 0.1 s
Power consumption	110 VAC: Approx. 2.9 VA (1.6 W) 220 VAC: Approx. 7.0 VA (1.6 W)
Control outputs	Contact output: 5 A at 250 VAC, resistive load (cosφ = 1)

■ Characteristics

Accuracy of operating time	±0.3% FS max. (±0.3% FS ±10 ms in ranges of 1.2 and 3 s)
Setting error	±5% FS ±0.05 s max.
Reset time	0.1 s max.
Influence of voltage	±0.5% FS max. (±0.5% FS ±10 ms in ranges of 1.2 and 3 s)
Influence of temperature	±2% FS max. (±2% FS ±10 ms in ranges of 1.2 and 3 s)
Insulation resistance	100 MΩ min. (at 500 VDC)
Dielectric strength	2,000 VAC, 50/60 Hz for 1 min (between current-carrying metal parts and exposed non-current-carrying metal parts) 2,000 VAC, 50/60 Hz for 1 min (between control output terminals and operating circuit) 1,000 VAC, 50/60 Hz for 1 min (between contacts not located next to each other)
Impulse withstand voltage	3 kV (between power terminals) 4.5 kV (between current-carrying terminal and exposed non-current-carrying metal parts)
Noise immunity	±1.5 kV (between power terminals), square-wave noise by noise simulator (pulse width:100 ns/1 μs, 1-ns rise)
Static immunity	Malfunction: 8 kV Destruction: 15 kV
Vibration resistance	Destruction: 10 to 55 Hz with 0.75-mm single amplitude each in three directions Malfunction: 10 to 55 Hz with 0.5-mm single amplitude each in three directions
Shock resistance	Destruction: 1,000 m/s ² (approx. 100G) each in three directions Malfunction: 100 m/s ² (approx. 10G) each in three directions
Ambient temperature	Operating: -10°C to 55°C (with no icing) Storage: -25°C to 65°C (with no icing)
Ambient humidity	Operating: 35% to 85%
Life expectancy	Mechanical: 20 million operations min. (under no load at 1,800 operations/h) Electrical: 100,000 operations min. (5 A at 250 VAC, resistive load at 1,800 operations/h)
Case color	Light Gray (Munsell 5Y7/1)
Enclosure ratings	IEC: IP40 (panel surface)
Weight	Approx. 100 g

Engineering Data (Reference)

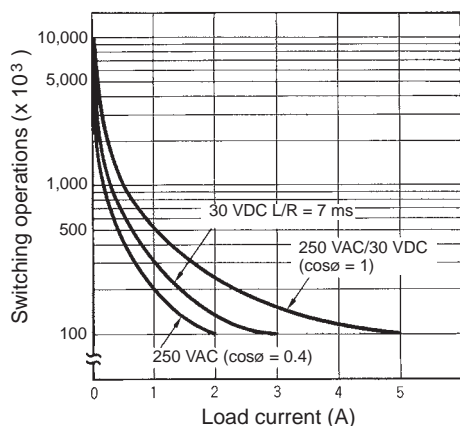

Reference: A maximum current of 0.15 A can be switched at 125 VDC ($\cos\phi = 1$) and a maximum current of 0.1 A can be switched at 125 VDC and L/R = 7ms. In both cases, a life of 100,000 operations can be expected. The minimum applicable load is 10 mA at 5 VDC (failure level: P).

Nomenclature

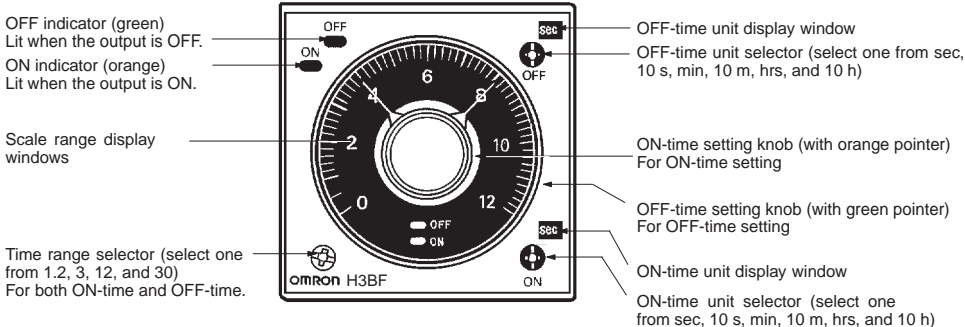

Operation

Block Diagrams

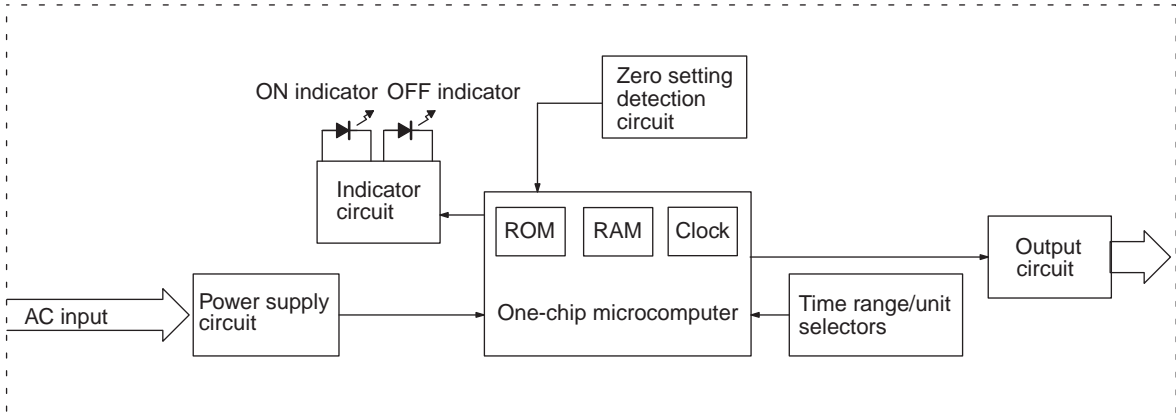

I/O Functions

Inputs	---	
Outputs	Control output	Outputs are turned ON/OFF according to the time set by the ON- and OFF-time setting knob.

■ Timing Chart

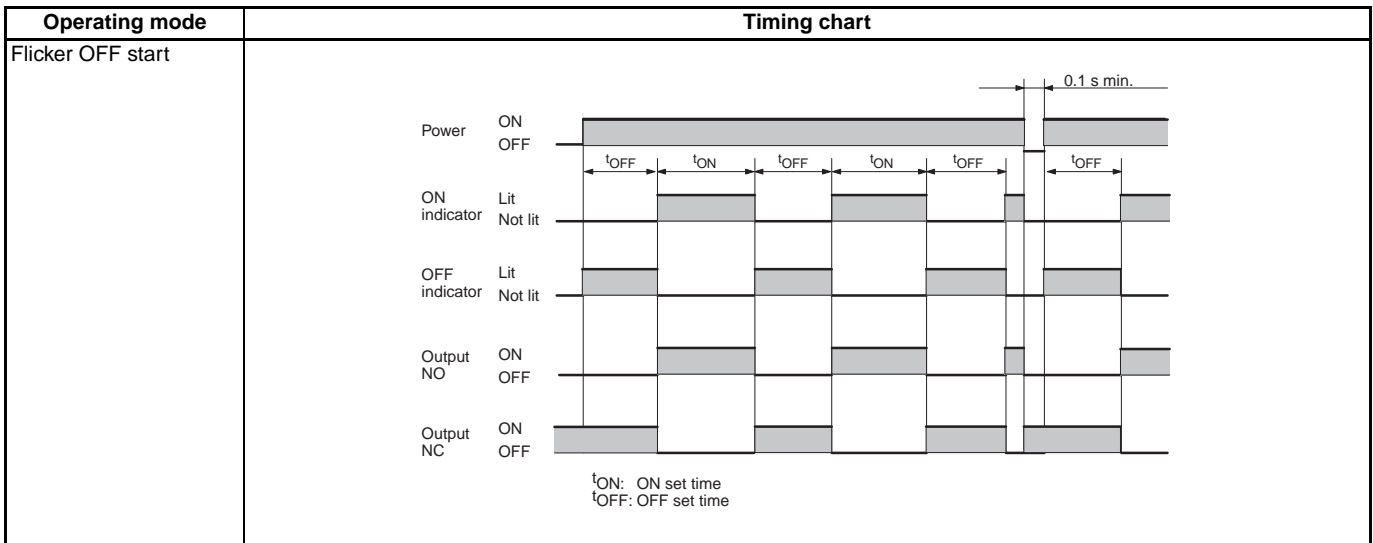

Note: Provide at least 0.1 s for the reset time.

Dimensions

Note: All units are in millimeters unless otherwise indicated.

H3BF-N8

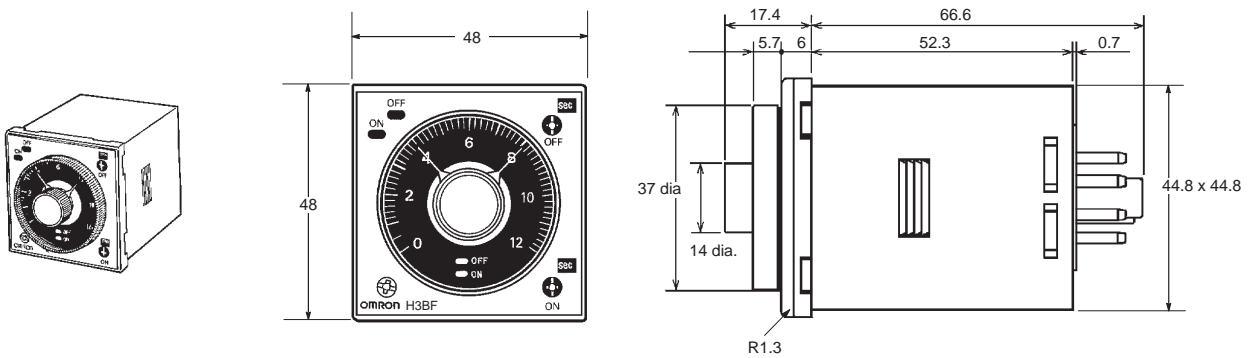

Installation

■ Terminal Arrangement

H3BF-N8

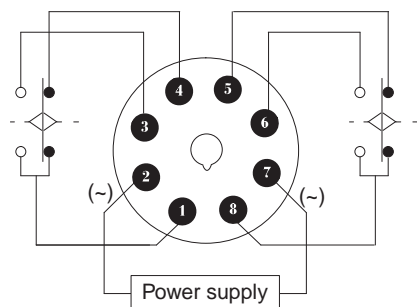

Solid-state Star-delta Timer H3BG-N8

- A wide star-time range (up to 120 seconds) and star-delta transfer time range (up to 1.0 seconds).
- Setting rings (order separately) to enable consistent settings and to limit the setting range.
- Panel Covers (order separately) to enable various panel designs.
- Approved by UL, CSA, CE and CCC.



Model Number Structure

Model Number Legend

H3BG-N□□
1 2

1. Configuration

8: 8-pin socket

2. Outputs

None: Star-delta operation contact

H: Star-delta operation contact and instantaneous contact

Ordering Information

List of Models

Outputs	Supply voltage	Models
Time-limit contact	110 VAC (50/60 Hz)	H3BG-N8
	220 VAC (50/60 Hz)	
Time-limit contact and instantaneous contact	110 VAC (50/60 Hz)	H3BG-N8H
	220 VAC (50/60 Hz)	

Note: Specify both the model number and supply voltage when ordering.

Example: H3BG-N8 110 VAC



■ Accessories (Order Separately)

Name/specifications		Models
Flush Mounting Adapters		Y92F-30
		Y92F-70
		Y92F-71
Mounting Tracks	50 cm (l) × 7.3 mm (t)	PFP-50N
	1 m (l) × 7.3 mm (t)	PFP-100N
	1 m (l) × 16 mm (t)	PFP-100N2
End Plate		PFP-M
Spacer		PFP-S
Protective Cover		Y92A-48B
Track Mounting/Front Connecting Socket	8-pin	P2CF-08
Back Connecting Socket		P3G-08
Time Setting Rings	Setting a specific time	Y92S-27
	Limiting the setting range	Y92S-28
Panel Covers (See note)	Light gray (5Y7/1)	Y92P-48GL
	Black (N1.5)	Y92P-48GB
Hold-down Clips	For PL08 Socket	Y92H-1
	For PF085A Socket	Y92H-2

Note: The Time Setting Ring and Panel Cover are sold together.

Specifications

■ General

Item	H3BG-N8	H3BG-N8H
Functions	Star-delta timer	Star-delta timer with instantaneous output
Pin type	8-pin	
Operating/Reset method	Time-limit operation/Self-reset	
Output type	Time-limit: SPST-NO (star operation circuit) SPST-NO (delta operation circuit)	Time-limit: SPST-NO (star operation circuit) SPST-NO (delta operation circuit) Instantaneous: SPST-NO
Mounting method	DIN track mounting, surface mounting, and flush mounting	
Approved standards	UL508, CSA C22.2 No.14, CCC Conforms to EN61812-1 (Pollution degree 2 / Overvoltage category III)	

■ Time Ranges

Star-delta transfer time		0.05 sec	0.1 sec	0.25 sec	0.5 sec	0.75 sec	1.0 sec
Full scale setting							
6	Star operation time setting	0.5 to 6 sec					
12		1 to 12 sec					
60		5 to 60 sec					
120		10 to 120 sec					

■ Ratings

Rated supply voltage	110 VAC (50/60 Hz), 220 VAC (50/60 Hz)
Operating voltage range	85% to 110% of rated supply voltage
Power reset	Minimum power-opening time: 0.5 s
Power consumption	110 VAC: Approx. 4.6 VA (2.3 W) 220 VAC: Approx. 9.5 VA (2.3 W)
Control outputs	Contact output: 5 A at 250 VAC, resistive load (cosφ = 1)

■ Characteristics

Accuracy of operating time	±0.3% FS max.
Setting error	±5% FS ±0.05 s max.
Star-delta transfer time	Accuracy: ±25% FS + 5 ms max.
Influence of voltage	±0.5% FS max.
Influence of temperature	±2% FS max.
Insulation resistance	100 MΩ min. (at 500 VDC)
Dielectric strength	2,000 VAC, 50/60 Hz for 1 min (between current-carrying metal parts and exposed non-current-carrying metal parts) 2,000 VAC, 50/60 Hz for 1 min (between control output terminals and operating circuit) 1,000 VAC, 50/60 Hz for 1 min (between contacts not located next to each other)
Impulse withstand voltage	3 kV (between power terminals) 4.5 kV (between current-carrying terminal and exposed non-current-carrying metal parts)
Noise immunity	±1.5 kV (between power terminals), square-wave noise by noise simulator (pulse width: 100 ns/1 μs, 1-ns rise)
Static immunity	Malfunction: 8 kV Destruction: 15 kV
Vibration resistance	Destruction: 10 to 55 Hz with 0.75-mm single amplitude each in three directions Malfunction: 10 to 55 Hz with 0.5-mm single amplitude each in three directions
Shock resistance	Destruction: 1,000 m/s ² (approx. 100G) each in three directions Malfunction: 300 m/s ² (approx. 30G) each in three directions
Ambient temperature	Operating: -10°C to 55°C (with no icing) Storage: -25°C to 65°C (with no icing)
Ambient humidity	Operating: 35% to 85%
Life expectancy	Mechanical: 20 million operations min. (under no load at 1,800 operations/h) Electrical: 100,000 operations min. (5 A at 250 VAC, resistive load at 1,800 operations/h)
Case color	Light Gray (Munsell 5Y7/1)
Enclosure ratings	IEC: IP40 (panel surface)
Weight	H3BG-N8: Approx. 110 g; H3BG-N8H: Approx. 130 g

Engineering Data (Reference)

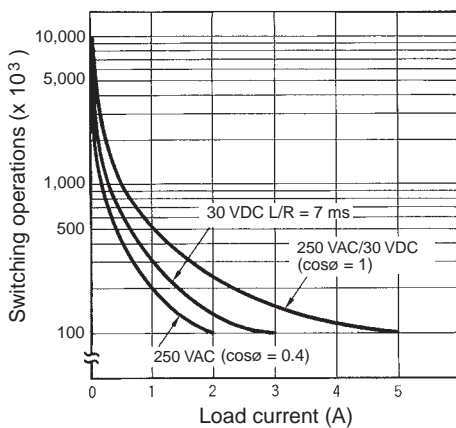

Reference: A maximum current of 0.15 A can be switched at 125 VDC (cosφ = 1) and a maximum current of 0.1 A can be switched at 125 VDC and L/R = 7ms. In both cases, a life of 100,000 operations can be expected. The minimum applicable load is 100 mA at 5 VDC (failure level: P).

Nomenclature

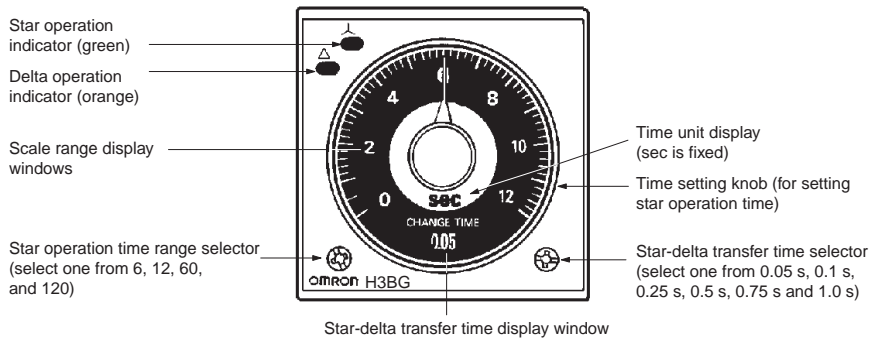

Operation

Block Diagrams

H3BG-N8

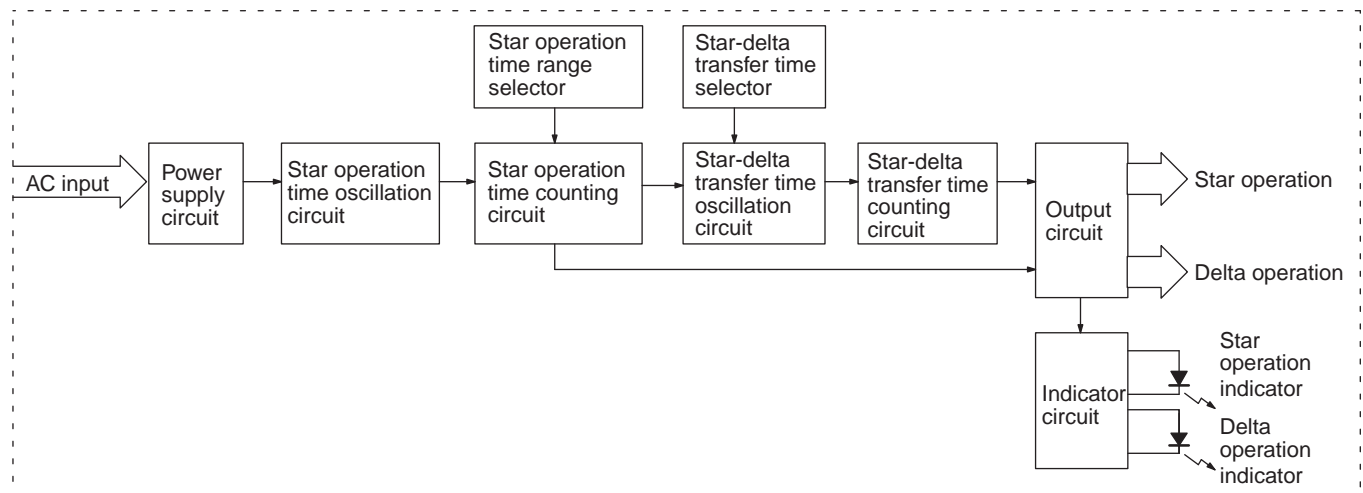

H3BG-N8H

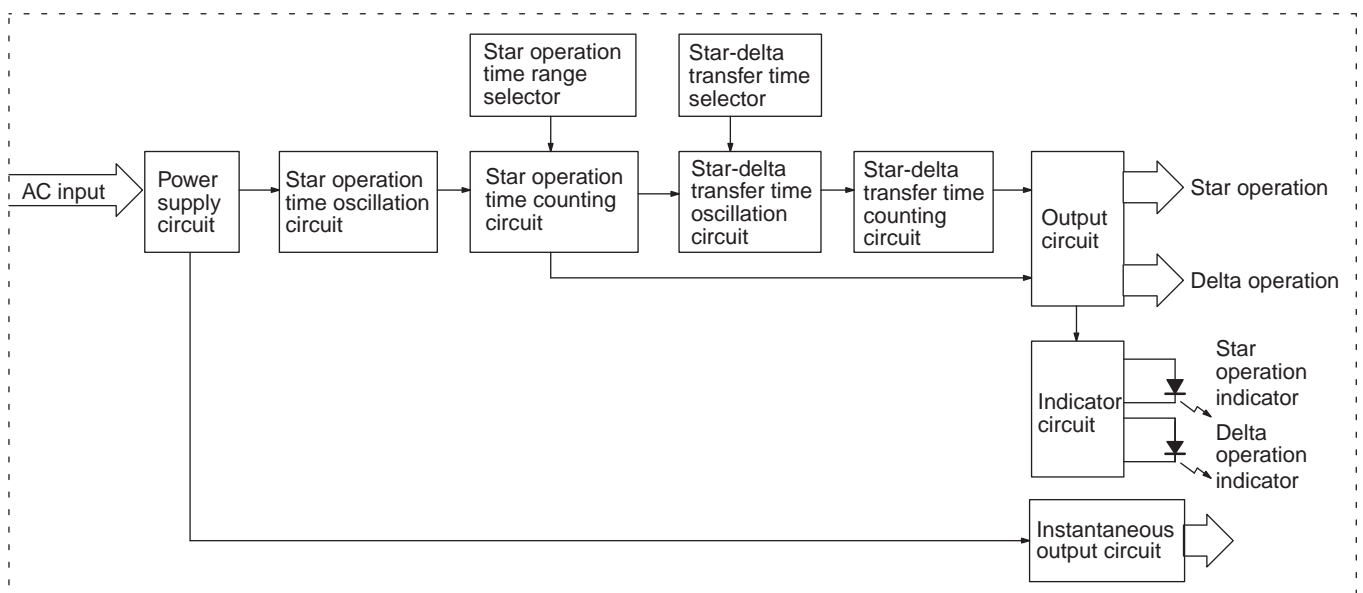

I/O Functions

Inputs		---
Outputs	Control output	If the time reaches the value set with the time setting knob, the star operation output will be turned OFF and there will be delta operation output after the set star-delta transfer time has elapsed.

Using the Setting Ring

Setting a Specific Time

Mount the Panel Cover on the Timer, set the desired time with the time setting knob, and place Time Setting Ring A onto the time setting knob so that the time setting notch of Time Setting Ring A is in the center of the reset lock position of the Panel cover.

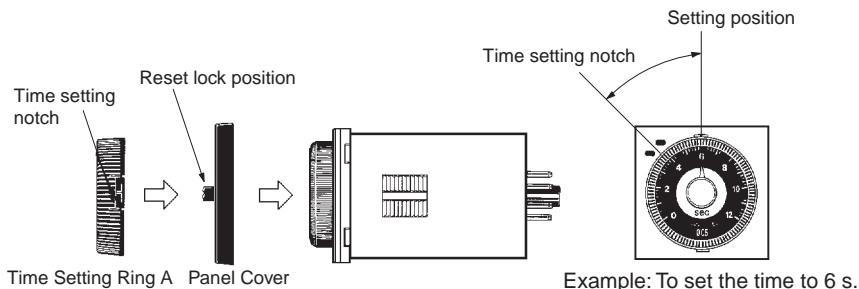

Limiting the Setting Range

Example: To set a range of 4 and 8 s.

Mount the Panel Cover on the Timer, set the time setting knob to 4 s (the lower limit of the setting range), and place Time Setting Ring C onto the time setting knob so that the stopper of Time Setting Ring C is on the right edge of the reset lock position of the Panel cover. Next, set the time setting knob to 8 s (the upper limit of the setting range), place Time Setting Ring B onto the time setting knob so that the stopper of Time Setting Ring B is on the left edge of the reset lock position of the Panel Cover.

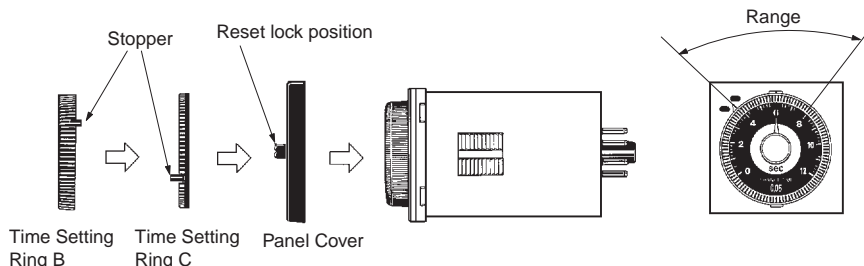

Timing Chart

Model	Timing chart		
H3BG-N8/N8H	Power (2 - 7)	ON OFF	[Timing diagram showing power pulse with 0.5 s min. duration]
	Instantaneous output (1 - 3)	ON OFF	[Timing diagram showing instantaneous output pulse]
	Star operation output (8 - 5)	ON OFF	[Timing diagram showing star operation output pulse with t1 and t2 durations]
	Delta operation output (8 - 6)	ON OFF	[Timing diagram showing delta operation output pulse]
	Star operation indicator	Lit Not lit	[Timing diagram showing star operation indicator pulse]
	Delta operation indicator	Lit Not lit	[Timing diagram showing delta operation indicator pulse]

Note: t1: Star operation time setting
t2: Star-delta transfer time

Note: Note: Instantaneous contacts are provided only for the H3BG-N8H.

Dimensions

Note: All units are in millimeters unless otherwise indicated.

H3BG-N8/N8H

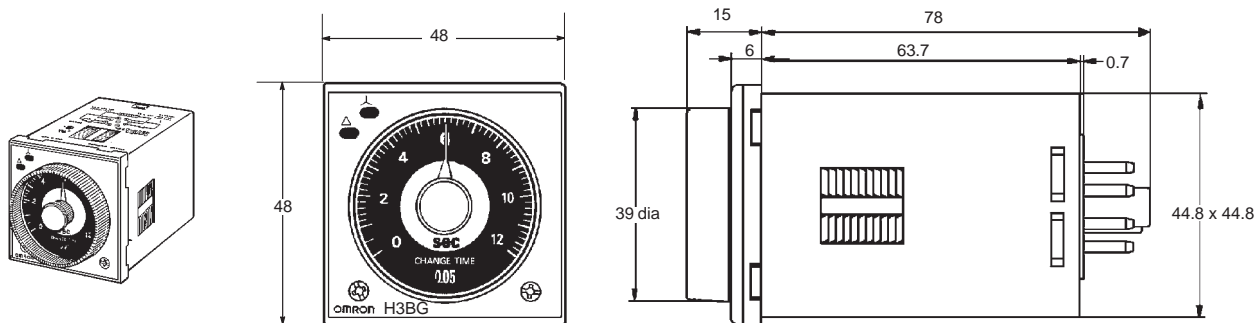

Dimensions with Set Ring

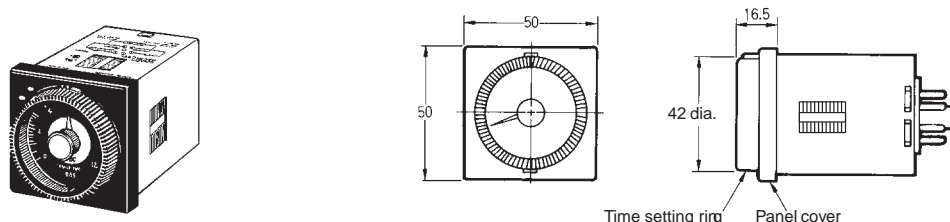

Accessories

Time Setting Ring/Panel Cover

There are two types of Panel Covers (Y92P-48GL and Y92P-48GB), all of which are available in two colors. Use the most suitable type of Panel Cover with the design of the scaling plate according to the application.

When setting a given time for the Timer, use of the Y92S-27 or Y92S-28 Time Setting Ring facilitates the time setting operation and minimizes possible setting errors by operators.

The Time Setting Ring and Panel Cover should be used as a pair.

Setting a specific time	Time Setting Ring A (Y92S-27) and Panel Cover (Y92P-48GL or -48GB)
Limiting the setting range	Time Setting Ring B or C (Y92S-28), and Panel Cover (Y92P-48GL or -48GB)

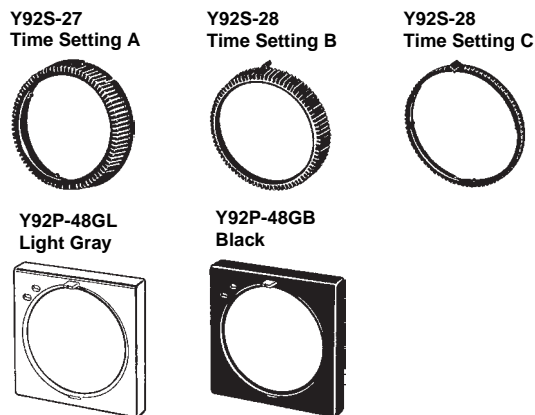

Installation

Terminal Arrangement

H3BG-N8

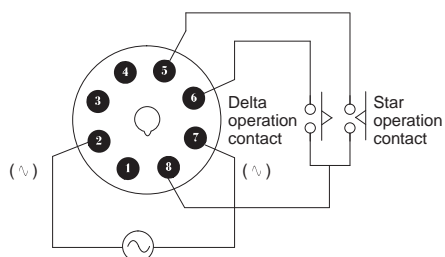

Note: Leave terminals 1, 3, and 4 open. Do not use them as relay terminals.

H3BG-N8H

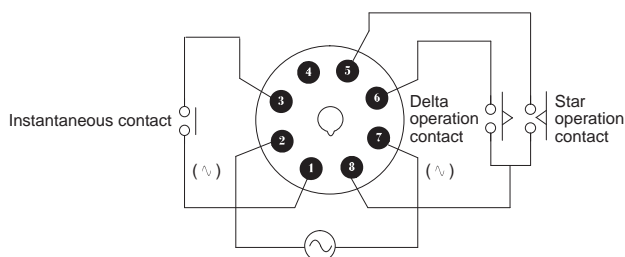

Note: Leave terminal 4 open. Do not use them as relay terminals.

Solid-state Power OFF-delay Timer H3BH-N8

- Long power OFF-delay times;
S-series: up to 12 seconds,
M-series: up to 12 minutes.
- Setting rings (order separately) to enable consistent settings and to limit the setting range.
- Panel Covers (order separately) to enable various panel designs.
- Approved by UL, CSA, CE and CCC.



Model Number Structure

Model Number Legend

H3BH-N□
1

1. Configuration
8: 8-pin socket

Ordering Information

List of Models

Output	Supply voltage	Timer	
		S-series	M-series
DPDT	110 VAC (50/60 Hz)	H3BH-N8	H3BH-N8
	220 VAC (50/60 Hz)		

Note: Specify both the supply voltage and time unit code (S or M) in addition to the model number when ordering.
Example: H3BH-N8 110 VAC M

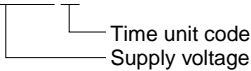

■ Accessories (Order Separately)

Name/specifications		Models
Flush Mounting Adapters		Y92F-30 Y92F-70 Y92F-71
Mounting Tracks	50 cm (l) × 7.3 mm (t)	PFP-50N
	1 m (l) × 7.3 mm (t)	PFP-100N
	1 m (l) × 16 mm (t)	PFP-100N2
End Plate		PFP-M
Spacer		PFP-S
Protective Cover		Y92A-48B
Track Mounting/Front Connecting Socket	8-pin	P2CF-08
Back Connecting Socket	8-pin	P3G-08
Hold-down Clips	For PL08 Socket	Y92H-1
	For PF085A Socket	Y92H-2

Specifications

■ General

Item	H3BH-N8
Operating/Reset method	Instantaneous operation/Time-limit reset
Pin type	8-pin
Input type	---
Output type	Relay output (DPDT)
Mounting method	DIN track mounting, surface mounting, and flush mounting
Approved standards	UL508, CSA C22.2 No.14, CCC Conforms to EN61812-1 (Pollution degree 2 / Overvoltage category III)

■ Time Ranges

Time unit		S-series	M-series
Full scale setting		s (sec)	min
0.6	Set time	0.05 to 0.6	
1.2		0.1 to 1.2	
6		0.5 to 6	
12		1 to 12	
Min. power ON time		0.1 sec min.	2 sec min.
Limit-time repeat cycle		3 s min.	

Note: If the above minimum power ON time is not secured, the H3BH-N8 may not operate. Be sure to secure the above minimum power ON time.

■ Ratings

Rated supply voltage	110 VAC (50/60 Hz), 220 VAC (50/60 Hz)
Operating voltage range	85% to 110% of rated supply voltage
Power consumption	110 VAC: Approx. 0.17 VA (0.15 W) 220 VAC: Approx. 0.24 VA (0.18 W)
Control outputs	Contact output: 5 A at 250 VAC, resistive load ($\cos\phi = 1$)

■ Characteristics

Accuracy of operating time	±0.3% FS max. (±0.3% FS ±10 ms in ranges of 0.6 and 1.2 s)
Setting error	±5% FS ±0.05 s max.
Influence of voltage	±0.5% FS max. (±0.5% FS ±10 ms in ranges of 0.6 and 1.2 s)
Influence of temperature	±2% FS max. (±2% FS ±10 ms in ranges of 0.6 and 1.2 s)
Insulation resistance	100 MΩ min. (at 500 VDC)
Dielectric strength	2,000 VAC, 50/60 Hz for 1 min (between current-carrying metal parts and exposed non-current-carrying metal parts) 2,000 VAC, 50/60 Hz for 1 min (between control output terminals and operating circuit) 1,000 VAC, 50/60 Hz for 1 min (between contacts not located next to each other)
Impulse withstand voltage	3 kV (between power terminals) 4.5 kV (between current-carrying terminal and exposed non-current-carrying metal parts)
Noise immunity	±1.5 kV (between power terminals), square-wave noise by noise simulator (pulse width: 100 ns/1 μs, 1-ns rise)
Static immunity	Malfunction: 8 kV Destruction: 15 kV
Vibration resistance	Destruction: 10 to 55 Hz with 0.75-mm single amplitude each in three directions Malfunction: 10 to 55 Hz with 0.5-mm single amplitude each in three directions
Shock resistance	Destruction: 1,000 m/s ² (approx. 100G) each in three directions Malfunction: 100 m/s ² (approx. 10G) each in three directions
Ambient temperature	Operating: -10°C to 55°C (with no icing) Storage: -25°C to 65°C (with no icing)
Ambient humidity	Operating: 35% to 85%
Life expectancy	Mechanical: 10 million operations min. (under no load at 1,200 operations/h) Electrical: 100,000 operations min. (5 A at 250 VAC, resistive load at 1,200 operations/h)
Case color	Light Gray (Munsell 5Y7/1)
Enclosure ratings	IEC: IP40 (panel surface)
Weight	Approx. 120 g

Engineering Data (Reference)

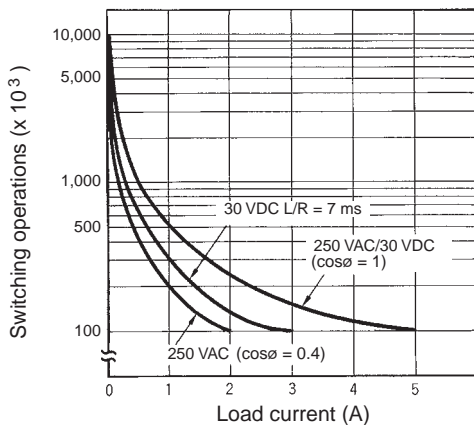

Reference: A maximum current of 0.15 A can be switched at 125 VDC ($\cos\phi = 1$) and a maximum current of 0.1 A can be switched at 125 VDC and L/R = 7ms. In both cases, a life of 100,000 operations can be expected. The minimum applicable load is 10 mA at 5 VDC (failure level: P).

Nomenclature

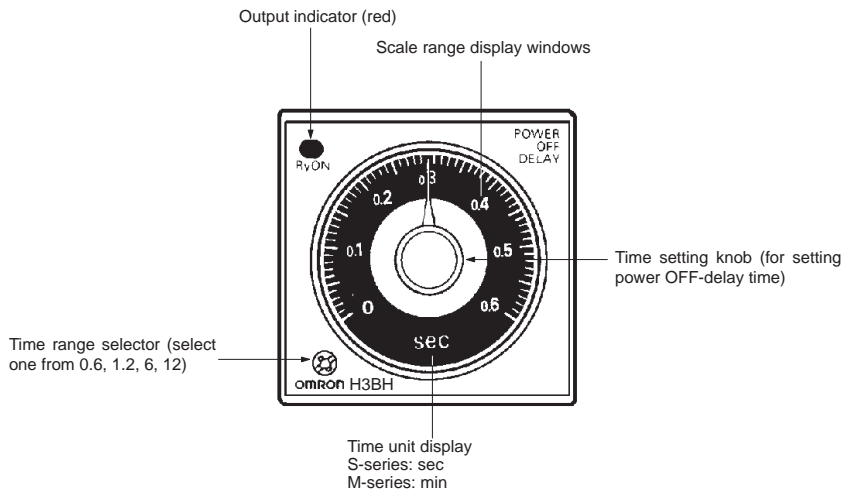

Operation

■ Block Diagrams

Without Reset Input (H3BH-N8)

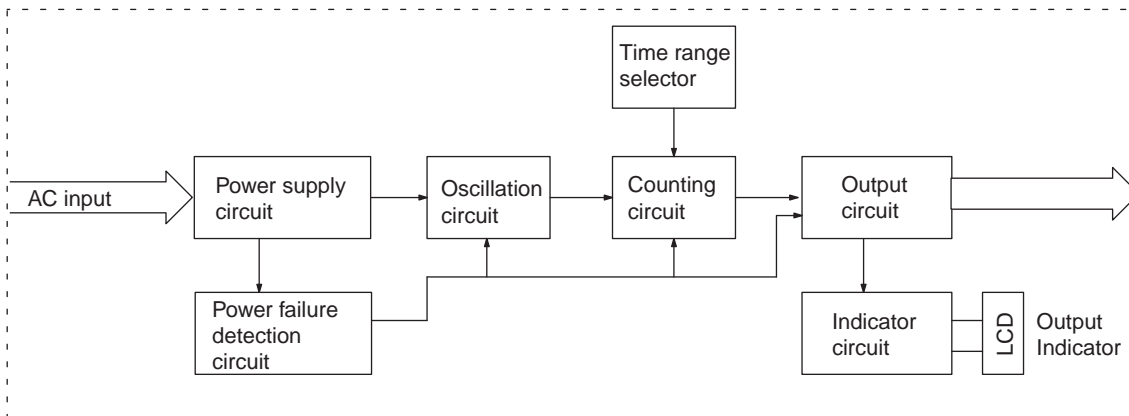

■ I/O Functions

Outputs	Control output	Operates instantaneously when the power is turned on and time-limit resets when the set time is up after the power is turned off.
----------------	-----------------------	---

■ Timing Chart

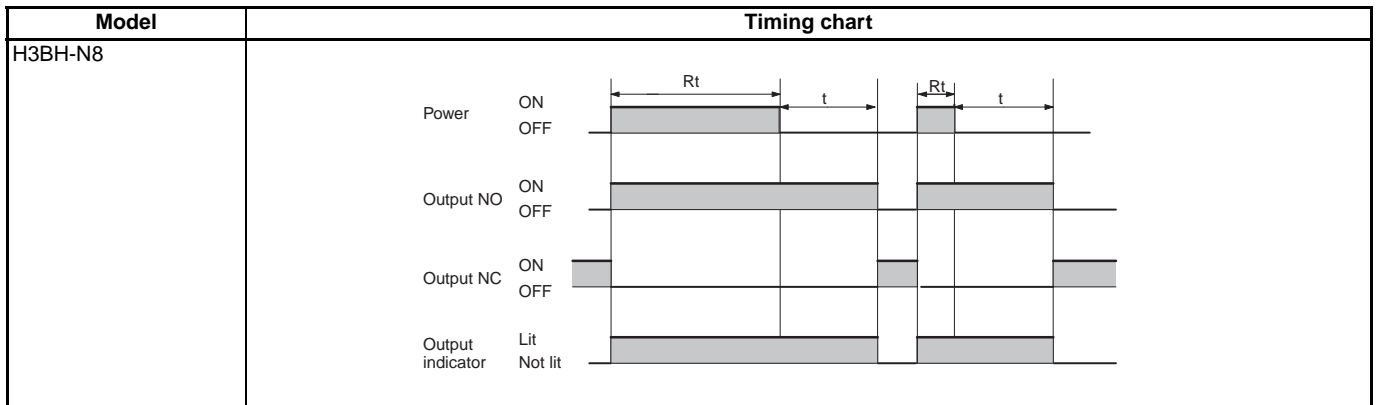

Note: t: Set time

Rt: Minimum power ON time (S-series: 0.1 s min.; M-series: 2 s min.). The Timer may not operate (the output may not turn ON) below this value.

Dimensions

Note: All units are in millimeters unless otherwise indicated.

H3BH-N8

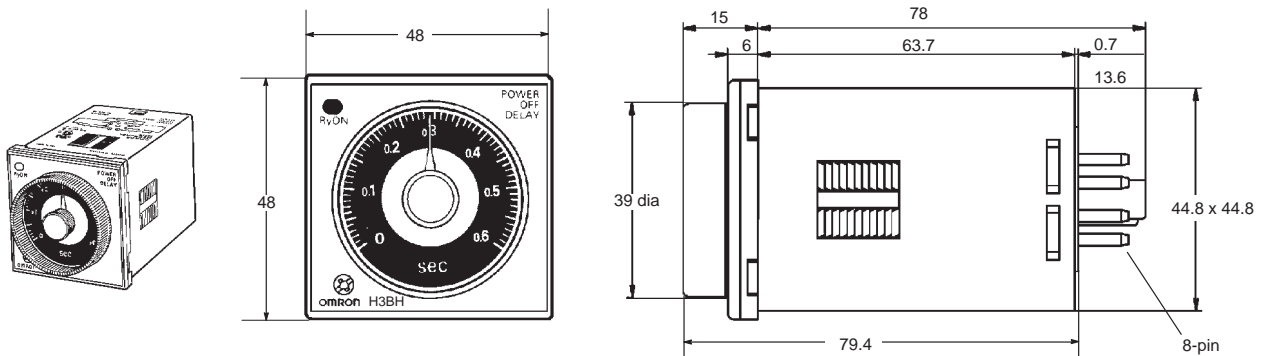

Installation

■ Terminal Arrangement

H3BH-N8

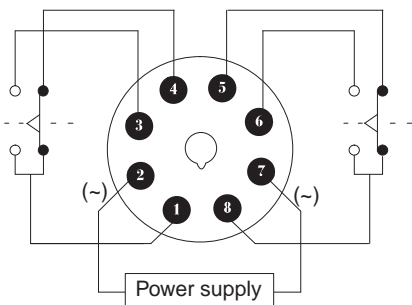

Operation

Note: The undermentioned is common for all H3BF-N/BG-N/BH-N models.

Basic Setting

Setting of Selectors

The selectors can be turned clockwise and counterclockwise to select the desired time unit, time range, or operating mode. Each selector has a snap mechanism that secures the selector at a given position. Set the selector at a position at which it is secured. Do not set it midway between two securing positions or a malfunction could result from improper setting.

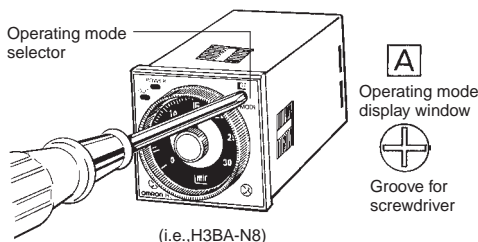

For OFF-time, the desired time unit (sec, 10 s, min, and hrs, or 10 s, 10 min, hrs, and 10 h) is indicated in the OFF-time unit display window at the upper right corner of the front panel and can be changed by turning the OFF-time unit selector located below the OFF-time unit display window.

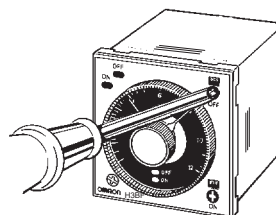

Selection of Time Unit and Time Range

H3BF-N8 Twin Timers

A time range (0 to 1.2, 0 to 3, 0 to 12, or 0 to 30) is selected for ON and OFF-time using the time range selector at the lower left corner of the front panel, and the selected time range appears within the plastic frame of the time setting knob (= scale range display windows).

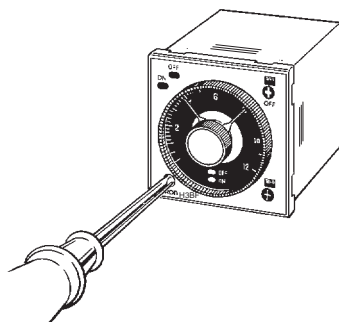

H3BG-N8/N8H Star-delta Timers

A star operation time range (0 to 6, 0 to 12, 0 to 60, or 0 to 120 seconds) is selected with the star operation time range selector at the lower left corner of the front panel.

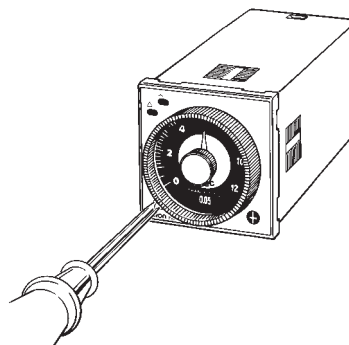

For ON-time, the desired time unit (sec, 10 s, min, and hrs, or 10 s, 10 min, hrs, and 10 h) is indicated in the ON-time unit display window at the lower right corner of the front panel and can be changed by turning the ON-time unit selector located below the ON-time unit display window.

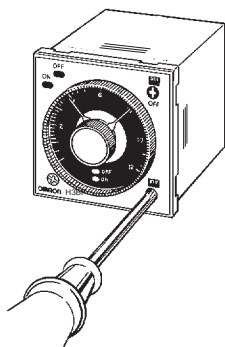

The time required for switching (0.05, 0.1, 0.25, 0.5, 0.75, or 1.0 second) from the star operation to the delta operation of the H3BG-N8/N8H can be selected with the star-delta transfer time selector at the lower right corner of the front panel.

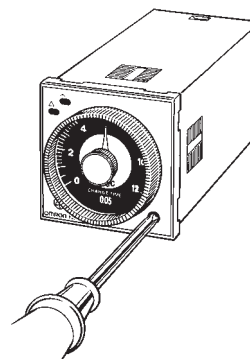

H3BH-N8 Power OFF-delay Timers

A time range (0 to 0.6, 0 to 1.2, 0 to 6, and 0 to 12) is selected with the time range selector at the lower left corner of the front panel. No time unit selector is available. When ordering the H3BH-N8, specify "S" for the second unit or "M" for the minute unit.

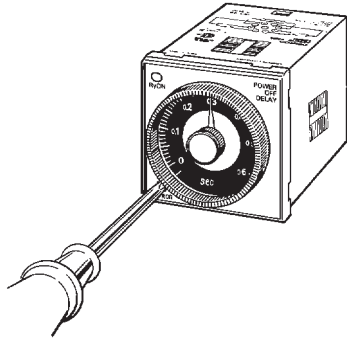

Dimensions

Note: The undermentioned is common for all H3B□-N models.

Note: All units are in millimeters unless otherwise indicated.

Dimensions with Flush Mounting Adapter

Y92F-30

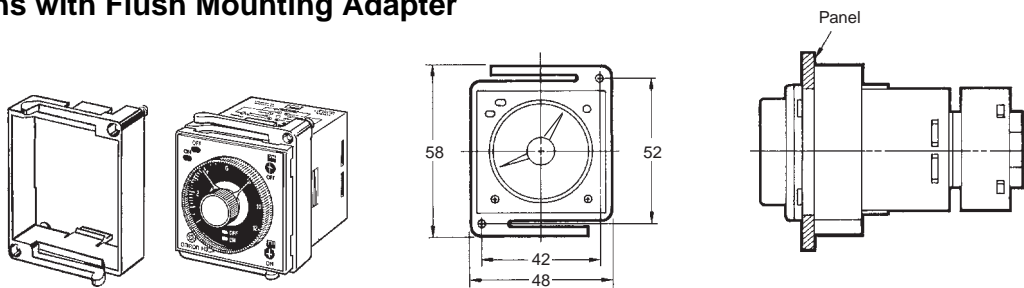

Note: The adapters for two or more timers mounted in a vertical line are different in orientation from those mounted in a horizontal line.

N can be obtained as follows (n: the number of H3BF-N/BG-N/BH-N models arranged side by side)

Without a Cover: $N = (48n - 2.5)^{+1/-0}$

With the Protective Cover: $N = (51n - 5.5)^{+1/-0}$

With the Panel Cover: $N = (50n - 4.5)^{+1/-0}$

Panel Cutout

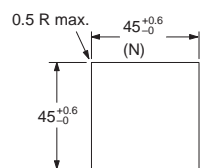

**Dimensions with Flush Mounting Adapter
Y92F-73/-70**

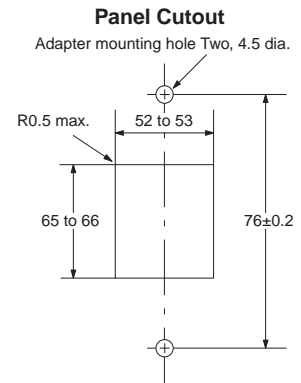
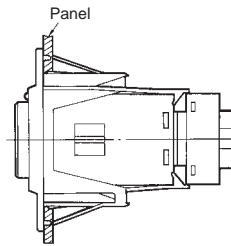
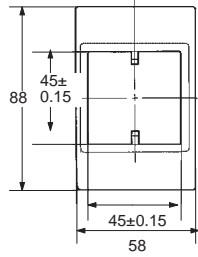
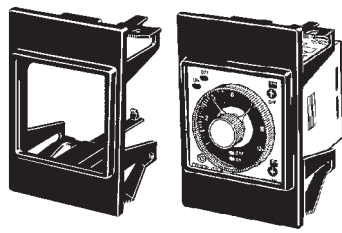

Note: The mounting panel thickness should be 1 to 3.2 mm.

**Dimensions with Flush Mounting Adapter
Y92F-74/-71**

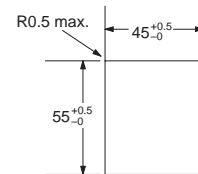
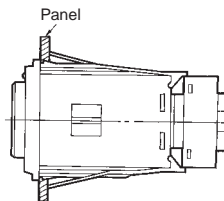
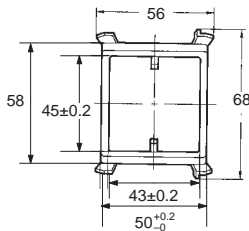
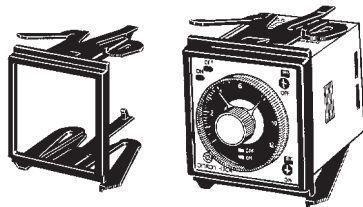

Note: The mounting panel thickness should be 1 to 3.2 mm.

Track Mounting

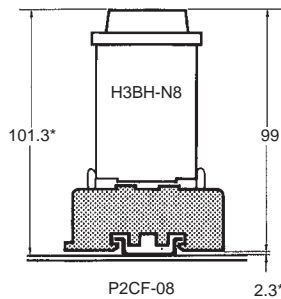
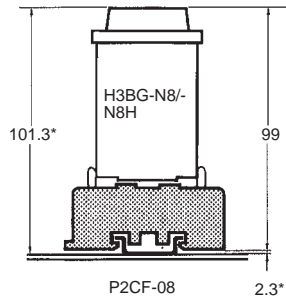
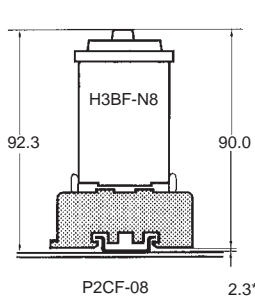

*These dimensions vary with the kind of DIN track (reference value).

Flush Mounting

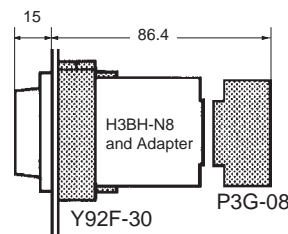
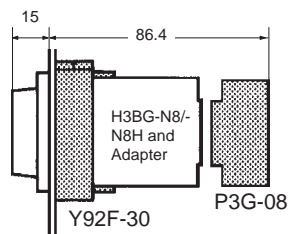
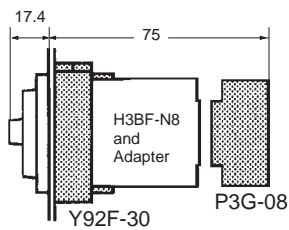

■ Accessories (Order Separately)

Track Mounting/Front Connecting Socket

P2CF-08

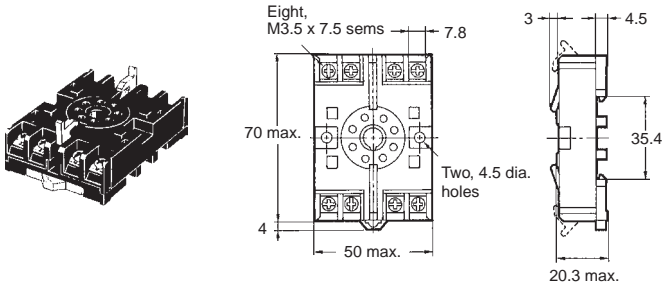

**Terminal Arrangement/
Internal Connections
(Top View)**

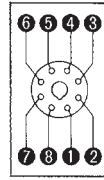

Surface Mounting Holes

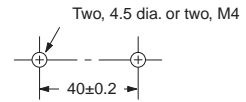

Back Connecting Socket

P3G-08

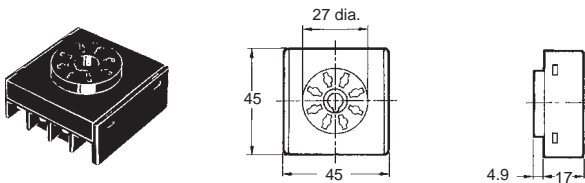

**Terminal Arrangement/
Internal Connections
(Bottom View)**

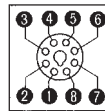

Mounting Track

PFP-100N, PFP-50N

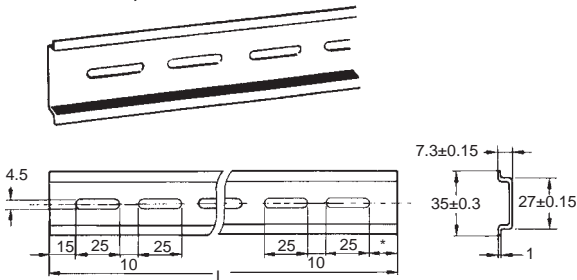

PFP-100N2

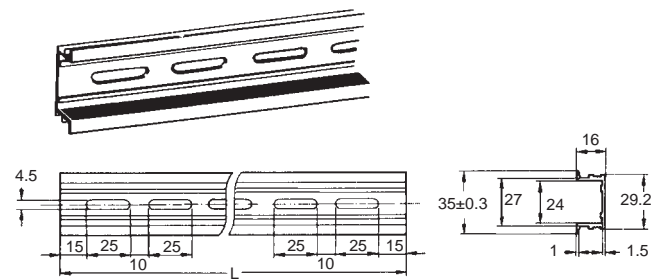

L: Length

1 m	PFP-100N
50 cm	PFP-50N
1 m	PFP-100N2

End Plate

PFP-M

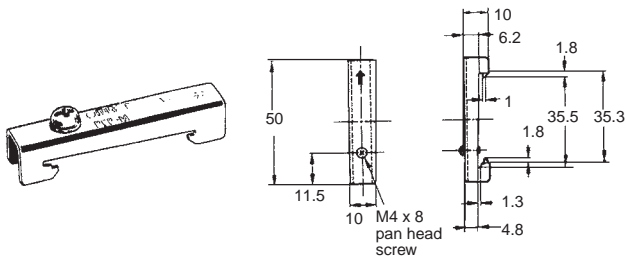

Spacer

PFP-S

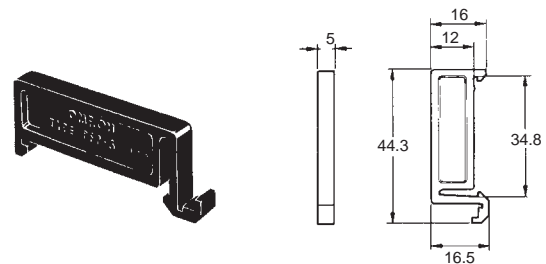

Protective Cover

Y92A-48B

The protective cover protects the front panel, particularly the time setting section, against dust, dirt, and water. It also prevents the set value from being altered due to accidental contact with the time setting knob.

- Note:**
1. The Y92A-48B Protective Cover is made of a hard plastic and therefore it must be removed to change the timer set value.
 2. The Protective Cover cannot be mounted if the Panel Cover (sold separately) is used on the Timer.

Y92A-48B

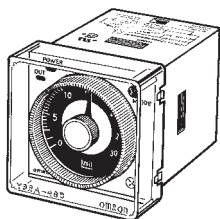

Hold-down Clip

Y92H-7/-1

For PL08 Socket

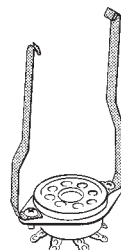

Y92H-8/-2

For PF085A Socket

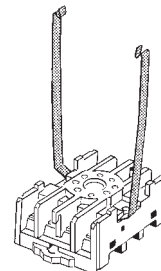

Safety Precautions

Note: The undermentioned is common for all H3B□-N models.

A transformer is not used in the power supplies for the H3B□-N. Therefore, an electrical shock may be received by touching the input terminals when the power supply voltage is being applied. Take adequate precautions to protect against electrical shock.

Changing of Settings

NOTICE: Do not change the time unit, time range, or operation mode while the timer is in operation or malfunction could result.

Power Supplies (H3BH-N8)

Connect the power supply voltage through a relay or switch in such a way that the voltage reaches a fixed value at once or the Timer may not be reset or a timer error could result.

The H3BH-N8 has a large inrush current; provide sufficient power supply capacity. If the power supply capacity is too small, there may be delays in turning ON the output.

Input/Output (H3BH-N8)

The H3B□-N-series models have a transformerless power supply.

Wiring (H3BH-N8)

The H3BH-N8 has a high impedance circuit. Therefore, the H3BH-N8 may not be reset if the H3BH-N8 is influenced by inductive voltage. In order to eliminate any influence of inductive voltage, the wires connected to the H3BH-N8 must be kept as short as possible and should not be installed alongside power lines. If the H3BH-N8 is influenced by inductive voltage that is 30% or more of the rated voltage, connect a CR filter with a capacitance of approximately 0.1 μF and a resistance of approximately 120 Ω or a bleeder resistor between the power supply terminals. If there is any residual voltage due to current leakage, connect a bleeder resistor between the power supply terminals.

Operation (H3BH-N8)

An interval of 3 s minimum is required to turn on the H3BH-N8 after the H3BH-N8 is turned off. If the H3BH-N8 is turned on and off repeatedly with an interval of shorter than 3 s, the internal parts of the H3BH-N8 may deteriorate and the H3BH-N8 may malfunction.

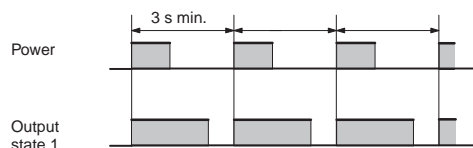

If it is required that the output be turned on repeatedly with an interval of shorter than 3 s, consider using the H3BA-N in mode D (signal OFF-delay).

Others

Since latching relays are used in the H3BH-N8, output contacts may become reversed or set to neutral state when an impact is applied to the Timer. If the Timer has been dropped, be sure to reinspect the Timer before using it again.

Read and Understand this Catalog

Please read and understand this catalog before purchasing the product. Please consult your OMRON representative if you have any questions or comments.

Warranty and Limitations of Liability

WARRANTY

OMRON's exclusive warranty is that the products are free from defects in materials and workmanship for a period of one year (or other period if specified) from date of sale by OMRON.

OMRON MAKES NO WARRANTY OR REPRESENTATION, EXPRESS OR IMPLIED, REGARDING NON-INFRINGEMENT, MERCHANTABILITY, OR FITNESS FOR PARTICULAR PURPOSE OF THE PRODUCTS. ANY BUYER OR USER ACKNOWLEDGES THAT THE BUYER OR USER ALONE HAS DETERMINED THAT THE PRODUCTS WILL SUITABLY MEET THE REQUIREMENTS OF THEIR INTENDED USE. OMRON DISCLAIMS ALL OTHER WARRANTIES, EXPRESS OR IMPLIED.

LIMITATIONS OF LIABILITY

OMRON SHALL NOT BE RESPONSIBLE FOR SPECIAL, INDIRECT, OR CONSEQUENTIAL DAMAGES, LOSS OF PROFITS OR COMMERCIAL LOSS IN ANY WAY CONNECTED WITH THE PRODUCTS, WHETHER SUCH CLAIM IS BASED ON CONTRACT, WARRANTY, NEGLIGENCE, OR STRICT LIABILITY.

In no event shall the responsibility of OMRON for any act exceed the individual price of the product on which liability is asserted.

IN NO EVENT SHALL OMRON BE RESPONSIBLE FOR WARRANTY, REPAIR, OR OTHER CLAIMS REGARDING THE PRODUCTS UNLESS OMRON'S ANALYSIS CONFIRMS THAT THE PRODUCTS WERE PROPERLY HANDLED, STORED, INSTALLED, AND MAINTAINED AND NOT SUBJECT TO CONTAMINATION, ABUSE, MISUSE, OR INAPPROPRIATE MODIFICATION OR REPAIR.

Application Considerations

SUITABILITY FOR USE

OMRON shall not be responsible for conformity with any standards, codes, or regulations that apply to the combination of the product in the customer's application or use of the product.

Take all necessary steps to determine the suitability of the product for the systems, machines, and equipment with which it will be used.

Know and observe all prohibitions of use applicable to this product.

NEVER USE THE PRODUCT FOR AN APPLICATION INVOLVING SERIOUS RISK TO LIFE OR PROPERTY WITHOUT ENSURING THAT THE SYSTEM AS A WHOLE HAS BEEN DESIGNED TO ADDRESS THE RISKS, AND THAT THE OMRON PRODUCT IS PROPERLY RATED AND INSTALLED FOR THE INTENDED USE WITHIN THE OVERALL EQUIPMENT OR SYSTEM.

PROGRAMMABLE PRODUCTS

OMRON shall not be responsible for the user's programming of a programmable product, or any consequence thereof.

Disclaimers

CHANGE IN SPECIFICATIONS

Product specifications and accessories may be changed at any time based on improvements and other reasons. Consult with your OMRON representative at any time to confirm actual specifications of purchased product.

DIMENSIONS AND WEIGHTS

Dimensions and weights are nominal and are not to be used for manufacturing purposes, even when tolerances are shown.

PERFORMANCE DATA

Performance data given in this catalog is provided as a guide for the user in determining suitability and does not constitute a warranty. It may represent the result of OMRON's test conditions, and the users must correlate it to actual application requirements. Actual performance is subject to the OMRON Warranty and Limitations of Liability.

OMRON Corporation Industrial Automation Company

Tokyo, JAPAN

Contact: www.ia.omron.com

Regional Headquarters

OMRON EUROPE B.V.

Wegalaan 67-69-2132 JD Hoofddorp
The Netherlands
Tel: (31)2356-81-300/Fax: (31)2356-81-388

OMRON ELECTRONICS LLC

One Commerce Drive Schaumburg,
IL 60173-5302 U.S.A.
Tel: (1) 847-843-7900/Fax: (1) 847-843-7787

OMRON ASIA PACIFIC PTE. LTD.

No. 438A Alexandra Road # 05-05/08 (Lobby 2),
Alexandra Technopark,
Singapore 119967
Tel: (65) 6835-3011/Fax: (65) 6835-2711

OMRON (CHINA) CO., LTD.

Room 2211, Bank of China Tower,
200 Yin Cheng Zhong Road,
PuDong New Area, Shanghai, 200120, China
Tel: (86) 21-5037-2222/Fax: (86) 21-5037-2200

Authorized Distributor:

© OMRON Corporation 1997 All Rights Reserved.
In the interest of product improvement,
specifications are subject to change without notice.

CSM 1.1.0313

Cat. No. L094-E1-02

0313 (1197) (O)