

Base strip - MSTBA 2,5/16-G-5,08 - 1757381

Please be informed that the data shown in this PDF Document is generated from our Online Catalog. Please find the complete data in the user's documentation. Our General Terms of Use for Downloads are valid (<http://phoenixcontact.com/download>)

Header, Nominal current: 12 A, Rated voltage (III/2): 320 V, Number of positions: 16, Pitch: 5.08 mm, Color: green, Contact surface: Tin, Mounting: Wave soldering



The figure shows a 10-position version of the product

Why buy this product

- Other pin lengths available on request
- Plug-in direction parallel to the conductor axis
- W type with stand-off
- Standard pin strip for 320 V (III/2)



Key Commercial Data

Packing unit	50 STK
GTIN	
GTIN	4017918029913
Weight per Piece (excluding packing)	6.330 g
Custom tariff number	85366990
Country of origin	Germany

Technical data

Environmental Product Compliance

China RoHS	No hazardous substances above threshold values
------------	--

Dimensions

Length	12 mm
Pitch	5.08 mm
Dimension a	76.2 mm
Width	83.2 mm
Constructional height	8.6 mm
Height	12.1 mm

Base strip - MSTBA 2,5/16-G-5,08 - 1757381

Technical data

Dimensions

Length of the solder pin	3.5 mm
Pin dimensions	1 x 1 mm
Hole diameter	1.4 mm

General

Range of articles	MSTBA 2,5/..-G
Insulating material group	IIIa
Rated surge voltage (III/3)	4 kV
Rated surge voltage (III/2)	4 kV
Rated surge voltage (II/2)	4 kV
Rated voltage (III/3)	250 V
Rated voltage (III/2)	320 V
Rated voltage (II/2)	400 V
Connection in acc. with standard	EN-VDE
Nominal current I_N	12 A
Maximum load current	12 A
Insulating material	PBT
Flammability rating according to UL 94	V0
Color	green
Number of positions	16

Standards and Regulations

Connection in acc. with standard	EN-VDE
	CSA
Flammability rating according to UL 94	V0

Drawings

Drilling diagram

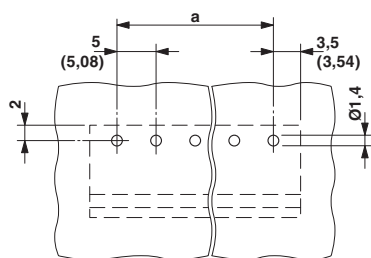

Diagram

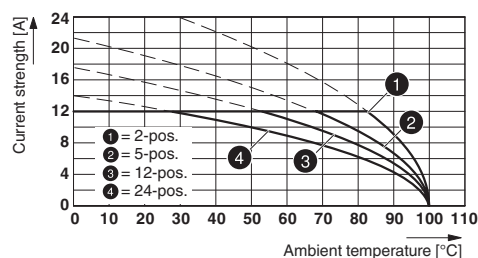

Type: ICV 2,5/..-G-5,08 with MSTBA 2,5/..-G-5,08

Base strip - MSTBA 2,5/16-G-5,08 - 1757381

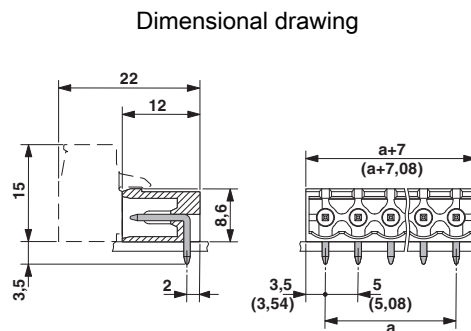
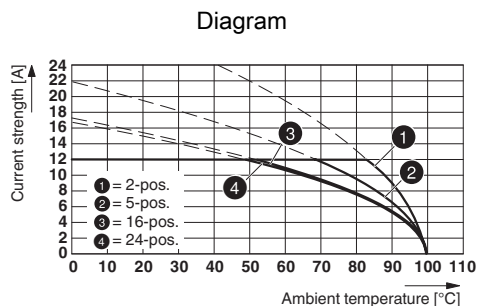

Type: IC 2,5/...-G-5,08 with MSTBA 2,5/...-G-5,08

Diagram

Diagram

Diagram

Diagram

Diagram

Classifications

eCl@ss

eCl@ss 4.0	272607xx
eCl@ss 4.1	27260701
eCl@ss 5.0	27260701
eCl@ss 5.1	27260701
eCl@ss 6.0	27260704
eCl@ss 7.0	27440402
eCl@ss 8.0	27440402
eCl@ss 9.0	27440402

ETIM

ETIM 3.0	EC001121
ETIM 4.0	EC002637
ETIM 5.0	EC002637

UNSPSC

UNSPSC 6.01	30211810
UNSPSC 7.0901	39121409
UNSPSC 11	39121409

Base strip - MSTBA 2,5/16-G-5,08 - 1757381

Classifications

UNSPSC

UNSPSC 12.01	39121409
UNSPSC 13.2	39121409

Approvals

Approvals

Approvals

CSA / VDE Gutachten mit Fertigungsüberwachung / IECCE CB Scheme / EAC / cULus Recognized / EAC

Ex Approvals

Approval details

CSA  http://www.csagroup.org/us/en/services/testing-and-certification/certified-product-listing 13631		
	B	D
Nominal current IN	15 A	10 A
Nominal voltage UN	300 V	300 V

VDE Gutachten mit Fertigungsüberwachung  http://www.vde.de 40004701	
Nominal current IN	12 A
Nominal voltage UN	250 V

IECCE CB Scheme  http://www.iecee.org/ DE1-56062-B1B2	
Nominal current IN	12 A
Nominal voltage UN	250 V

EAC EAC-Zulassung

cULus Recognized http://database.ul.com/cgi-bin/XYV/template/LISEXT/1FRAME/index.htm E60425-19931011		
	B	D
Nominal current IN	15 A	10 A

Base strip - MSTBA 2,5/16-G-5,08 - 1757381

Approvals

	B	D
Nominal voltage UN	300 V	300 V

EAC B.01742

Accessories

Accessories

Coding element

Coding star - CR-MSTB - 1734401



Coding section, inserted into the recess in the header or the inverted plug, red insulating material

Filler plug

Accessories - MSTB-BL - 1755477



Keying cap, for forming sections, plugs onto header pin, green insulating material

Labeled terminal marker

Marker card - SK 5,08/3,8:FORTL.ZAHLEN - 0804293



Marker card, Card, white, labeled, Horizontal: Consecutive numbers 1 - 10, 11 - 20, etc. up to 91 - (99)100, Mounting type: Adhesive, for terminal block width: 5.08 mm, Lettering field: 5.08 x 3.8 mm

Additional products

Printed-circuit board connector - FKCN 2,5/16-ST-5,08 - 1754704



Plug component, Nominal current: 12 A, Rated voltage (III/2): 320 V, Number of positions: 16, Pitch: 5.08 mm, Connection method: Push-in spring connection, Color: green, Contact surface: Tin

Base strip - MSTBA 2,5/16-G-5,08 - 1757381

Accessories

Printed-circuit board connector - MSTB 2,5/16-ST-5,08 - 1757158

Plug component, Nominal current: 12 A, Rated voltage (III/2): 320 V, Number of positions: 16, Pitch: 5.08 mm, Connection method: Screw connection with tension sleeve, Color: green, Contact surface: Tin



Printed-circuit board connector - MSTB 2,5/16-STZ-5,08 - 1764248

Plug component, Nominal current: 12 A, Rated voltage (III/2): 320 V, Number of positions: 16, Pitch: 5.08 mm, Connection method: Screw connection with tension sleeve, Color: green, Contact surface: Tin



Printed-circuit board connector - MSTBP 2,5/16-ST-5,08 - 1769159

Plug component, Nominal current: 12 A, Rated voltage (III/2): 320 V, Number of positions: 16, Pitch: 5.08 mm, Connection method: Screw connection with tension sleeve, Color: green, Contact surface: Tin



Printed-circuit board connector - FRONT-MSTB 2,5/16-ST-5,08 - 1777426

Plug component, Nominal current: 12 A, Rated voltage (III/2): 320 V, Number of positions: 16, Pitch: 5.08 mm, Connection method: Front screw connection, Color: green, Contact surface: Tin



Printed-circuit board connector - MSTBT 2,5/16-ST-5,08 - 1781124

Plug component, Nominal current: 12 A, Rated voltage (III/2): 320 V, Number of positions: 16, Pitch: 5.08 mm, Connection method: Screw connection with tension sleeve, Color: green, Contact surface: Tin



Base strip - MSTBA 2,5/16-G-5,08 - 1757381

Accessories

Printed-circuit board connector - MVSTBR 2,5/16-ST-5,08 - 1792388



Plug component, Nominal current: 12 A, Rated voltage (III/2): 320 V, Number of positions: 16, Pitch: 5.08 mm, Connection method: Screw connection with tension sleeve, Color: green, Contact surface: Tin

Printed-circuit board connector - MVSTBW 2,5/16-ST-5,08 - 1792896



Plug component, Nominal current: 12 A, Rated voltage (III/2): 320 V, Number of positions: 16, Pitch: 5.08 mm, Connection method: Screw connection with tension sleeve, Color: green, Contact surface: Tin

Printed-circuit board connector - MSTBC 2,5/16-ST-5,08 - 1808955



Plug component, Nominal current: 12 A, Rated voltage (III/2): 320 V, Number of positions: 16, Pitch: 5.08 mm, Connection method: Crimp connection, Color: green, Corresponding female crimp contacts with current [A] and conductor cross section range [mm²] data: 10A/MSTBC-MT 0,5-1,0 (3190564); 10A/MSTBC-MT 0,5-1,0 BA (3190645); 12A/MSTBC-MT 1,5-2,5 (3190551); 12A/MSTBC-MT 1,5-2,5 BA (3190658). BA = Bandkontakte

Printed-circuit board connector - MSTBC 2,5/16-STZ-5,08 - 1809640



Plug component, Nominal current: 12 A, Rated voltage (III/2): 320 V, Number of positions: 16, Pitch: 5.08 mm, Connection method: Crimp connection, Color: green, Corresponding female crimp contacts with current [A] and conductor cross section range [mm²] data: 10A/MSTBC-MT 0,5-1,0 (3190564); 10A/MSTBC-MT 0,5-1,0 BA (3190645); 12A/MSTBC-MT 1,5-2,5 (3190551); 12A/MSTBC-MT 1,5-2,5 BA (3190658). BA = Bandkontakte

Printed-circuit board connector - MSTBU 2,5/16-STD-5,08 - 1824269



Plug component, Nominal current: 12 A, Rated voltage (III/2): 320 V, Number of positions: 16, Pitch: 5.08 mm, Connection method: Screw connection with tension sleeve, Color: green, Contact surface: Tin, Mounting: Direct mounting

Base strip - MSTBA 2,5/16-G-5,08 - 1757381

Accessories

Printed-circuit board connector - MSTBU 2,5/16-ST-5,08-FL - 1824492



Plug component, Nominal current: 12 A, Rated voltage (III/2): 320 V, Number of positions: 16, Pitch: 5.08 mm, Connection method: Screw connection with tension sleeve, Color: green, Contact surface: Tin, Mounting: Direct mounting

Printed-circuit board connector - SMSTB 2,5/16-ST-5,08 - 1826429



Plug component, Nominal current: 12 A, Rated voltage (III/2): 320 V, Number of positions: 16, Pitch: 5.08 mm, Connection method: Screw connection with tension sleeve, Color: green, Contact surface: Tin

Plug - MSTBVK 2,5/16-ST-5,08 - 1831456



Plug component, Nominal current: 12 A, Rated voltage (III/2): 320 V, Number of positions: 16, Pitch: 5.08 mm, Connection method: Screw connection with tension sleeve, Color: green, Contact surface: Tin, Mounting: DIN rail

Printed-circuit board connector - UMSTBVK 2,5/16-ST-5,08 - 1833959



Plug component, Nominal current: 12 A, Rated voltage (III/2): 320 V, Number of positions: 16, Pitch: 5.08 mm, Connection method: Screw connection with tension sleeve, Color: green, Contact surface: Tin, Mounting: DIN rail

Printed-circuit board connector - FKC 2,5/16-ST-5,08 - 1873197



Plug component, Nominal current: 12 A, Rated voltage (III/2): 320 V, Number of positions: 16, Pitch: 5.08 mm, Connection method: Push-in spring connection, Color: green, Contact surface: Tin

Base strip - MSTBA 2,5/16-G-5,08 - 1757381

Accessories

Printed-circuit board connector - FKCVW 2,5/16-ST-5,08 - 1873799

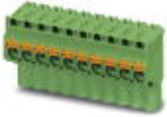

Plug component, Nominal current: 12 A, Rated voltage (III/2): 320 V, Number of positions: 16, Pitch: 5.08 mm, Connection method: Push-in spring connection, Color: green, Contact surface: Tin

Printed-circuit board connector - FKCVR 2,5/16-ST-5,08 - 1874099



Plug component, Nominal current: 12 A, Rated voltage (III/2): 320 V, Number of positions: 16, Pitch: 5.08 mm, Connection method: Push-in spring connection, Color: green, Contact surface: Tin

Printed-circuit board connector - QC 1/16-ST-5,08 - 1883844



Plug component, Nominal current: 10 A, Rated voltage (III/2): 630 V, Number of positions: 16, Pitch: 5.08 mm, Connection method: Displacement connection, Color: green, Contact surface: Tin

Printed-circuit board connector - FKCT 2,5/16-ST-5,08 - 1902259



Plug component, Nominal current: 12 A, Rated voltage (III/2): 320 V, Number of positions: 16, Pitch: 5.08 mm, Connection method: Push-in spring connection, Color: green, Contact surface: Tin

Printed-circuit board connector - FKCS 2,5/16-ST-5,08 - 1975215



Plug component, Nominal current: 12 A, Rated voltage (III/2): 320 V, Number of positions: 16, Pitch: 5.08 mm, Connection method: Push-in spring connection, Color: green, Contact surface: Tin

X-ON Electronics

Largest Supplier of Electrical and Electronic Components

Click to view similar products for [Headers & Wire Housings](#) category:

Click to view products by [Phoenix Contact](#) manufacturer:

Other Similar products are found below :

[95000-104TRLF](#) [10135584-644402LF](#) [DF62W-EP2022PCA](#) [95000-106TRLF](#) [DF62W-2022SCA](#) [DF62W-EP2022PC](#) [2203348](#) [DF62W-2022SC](#) [1084018](#) [1029039](#) [1084017](#) [802-10-012-10-002000](#) [1112640](#) [1112639](#) [000-34000](#) [0009482033](#) [0009507031](#) [57102-S06-03LF](#) [57202-S52-04LF](#) [PCN6-15S-2.5E](#) [0039019024](#) [58102-G61-06LF](#) [582553-1](#) [0009485154](#) [0009508121](#) [0022285053](#) [0050291907](#) [018731A](#) [LY20-4P-DT1-P1E-BR](#) [02.125.8002.8](#) [60101931](#) [60598-1 \(Cut Strip\)](#) [M1625-3R/100](#) [61062-3](#) [61082-181009](#) [636-1427](#) [638009-1](#) [641938-9](#) [641991-4](#) [644168-1](#) [647662-1](#) [65039-019ELF](#) [65781-047](#) [65817-002LF](#) [65817-015LF](#) [65863-015LF](#) [66207-023LF](#) [67016-026LF](#) [67046-001LF](#) [67095-007LF](#)