

## OPTOTRONIC ECO

Compact Constant Current – Non dimmable



### Areas of application

- Suitable for use in luminaires with flexible current setting (Tri-Tap)
- Suitable for indoor SELV equivalent installations
- Suitable for luminaires of protection classes I and II

### Product benefits

- Versatile scope of application due to output power range of up to 60 W
- Efficient and reliable

### Product features

- Supply voltage: 220...240 V
- Line frequency: 50 Hz | 60 Hz
- Line voltage: 198...264 V
- Safety according to EN 61347-1, 61347-2-13, 62384
- RI suppression according to EN 55015:2007+A1:2007/CDN
- Line harmonics according to EN 61000-3-2
- Immunity according to EN 61547
- Lifetime: up to 50,000 h (temperature at  $T_c = 65\text{ °C}$ , max. 10 % failure rate)

Technical data

Electrical data

Product description	Output power	Input voltage	Mains frequency	Output voltage
OTe 25/220...240/420 CS	23 W <sup>1)</sup>	198...264 V <sup>2)</sup>	50...60 Hz	27...54 V <sup>3)</sup>
OTe 25/220...240/700 CS	25 W <sup>8)</sup>	198...264 V <sup>2)</sup>	50...60 Hz	18...36 V <sup>9)</sup>
OTe 35/220...240/700 CS	35 W <sup>11)</sup>	195...264 V <sup>2)</sup>	50...60 Hz	27...54 V <sup>3)</sup>
OTe 35/220...240/700 CS S	35 W <sup>11)</sup>	195...264 V <sup>2)</sup>	50...60 Hz	27...54 V <sup>3)</sup>
OTe 35/220...240/1A0 CS	36 W <sup>13)</sup>	195...264 V <sup>2)</sup>	50...60 Hz	17...34 V <sup>9)</sup>
OTe 35/220...240/1A0 CS S	36 W <sup>13)</sup>	195...264 V <sup>2)</sup>	50...60 Hz	17...34 V <sup>9)</sup>
OTe 50/220...240/1A0 CS	50 W <sup>14)</sup>	198...264 V <sup>2)</sup>	50...60 Hz	27...54 V <sup>3)</sup>
OTe 50/220...240/1A4 CS	50 W <sup>15)</sup>	198...264 V <sup>2)</sup>	50...60 Hz	18...36 V <sup>9)</sup>
OTe 50/220...240/1A0 CS FAN	50 W <sup>16)</sup>	198...264 V <sup>2)</sup>	50...60 Hz	27...54 V <sup>3)</sup>

Product description	Output current	Nominal voltage	Device power loss	Power factor $\lambda$
OTe 25/220...240/420 CS	290 / 350 / 420 mA <sup>4)</sup>	220...240 V	4.0 W <sup>5)</sup>	0.95 <sup>6)</sup>
OTe 25/220...240/700 CS	500 / 600 / 700 mA <sup>4)</sup>	220...240 V	4.4 W <sup>10)</sup>	0.95 <sup>6)</sup>
OTe 35/220...240/700 CS	500 / 600 / 700 mA <sup>4)</sup>	220...240 V	5.3 W <sup>12)</sup>	0.95 <sup>6)</sup>
OTe 35/220...240/700 CS S	500 / 600 / 700 mA <sup>4)</sup>	220...240 V	5.3 W <sup>12)</sup>	0.95 <sup>6)</sup>
OTe 35/220...240/1A0 CS	800 / 925 / 1050 mA <sup>4)</sup>	220...240 V	5.5 W <sup>12)</sup>	0.95 <sup>6)</sup>
OTe 35/220...240/1A0 CS S	800 / 925 / 1050 mA <sup>4)</sup>	220...240 V	5.5 W <sup>12)</sup>	0.95 <sup>6)</sup>
OTe 50/220...240/1A0 CS	800 / 925 / 1050 mA <sup>4)</sup>	220...240 V	7.5 W <sup>12)</sup>	0.95 <sup>6)</sup>
OTe 50/220...240/1A4 CS	1150 / 1250 / 1400 mA <sup>4)</sup>	220...240 V	7.5 W <sup>12)</sup>	0.95 <sup>6)</sup>
OTe 50/220...240/1A0 CS FAN	700 / 900 / 1050 mA <sup>4)</sup>	220...240 V	8.1 W <sup>17)</sup>	0.95 <sup>18)</sup>

Product description	ECG efficiency	Nominal current
OTe 25/220...240/420 CS	85 % <sup>7)</sup>	
OTe 25/220...240/700 CS	85 % <sup>7)</sup>	
OTe 35/220...240/700 CS	87 % <sup>7)</sup>	
OTe 35/220...240/700 CS S	87 % <sup>7)</sup>	
OTe 35/220...240/1A0 CS	87 % <sup>7)</sup>	
OTe 35/220...240/1A0 CS S	87 % <sup>7)</sup>	
OTe 50/220...240/1A0 CS	87 % <sup>7)</sup>	
OTe 50/220...240/1A4 CS	87 % <sup>7)</sup>	
OTe 50/220...240/1A0 CS FAN	88 % <sup>7)</sup>	0.28 A <sup>12)</sup>

<sup>1)</sup> Partial load 8...23 W

## Product family datasheet

- 2) Permitted voltage range
- 3) Maximum 60 V
- 4)  $\pm 5\%$
- 5) At 230 V, Input power 27 W max.
- 6) Full load at 230 V/50 Hz
- 7) At full load and 230 V
- 8) Partial load 9...25 W
- 9) Maximum 50 V
- 10) At 230 V, Input power 29.4 W max.
- 11) Partial load 13...37 W
- 12) At 230 V
- 13) Partial load 14...36 W
- 14) Partial load 22...56 W
- 15) Partial load 21...50 W
- 17) Maximum
- 16) Partial load 19...56 W
- 18) Full load at 230 V

### Dimensions & weight

Product description	Length	Width	Height	Product weight
OTe 25/220...240/420 CS	97.0 mm	43.0 mm	29.5 mm	90.00 g
OTe 25/220...240/700 CS	97.0 mm	43.0 mm	29.5 mm	90.00 g
OTe 35/220...240/700 CS	103.0 mm	67.0 mm	29.5 mm	162.00 g
OTe 35/220...240/700 CS S	110.0 mm	43.0 mm	29.5 mm	135.00 g
OTe 35/220...240/1A0 CS	103.0 mm	67.0 mm	29.5 mm	165.00 g
OTe 35/220...240/1A0 CS S	110.0 mm	43.0 mm	29.5 mm	135.00 g
OTe 50/220...240/1A0 CS	103.0 mm	67.0 mm	29.5 mm	183.00 g
OTe 50/220...240/1A4 CS	103.0 mm	67.0 mm	29.5 mm	183.00 g
OTe 50/220...240/1A0 CS FAN	103.0 mm	67.0 mm	29.5 mm	188.00 g

Product description	Cable cross-section, input side	Cable cross-section, output side	Wire preparation length, input side
OTe 25/220...240/420 CS			
OTe 25/220...240/700 CS			
OTe 35/220...240/700 CS			
OTe 35/220...240/700 CS S			
OTe 35/220...240/1A0 CS			
OTe 35/220...240/1A0 CS S			
OTe 50/220...240/1A0 CS			
OTe 50/220...240/1A4 CS			

## Product family datasheet

Product description	Cable cross-section, input side	Cable cross-section, output side	Wire preparation length, input side
OTe 50/220...240/1A0 CS FAN	0.5...1.5 mm <sup>2 1)</sup>	0.5...1.5 mm <sup>2 1)</sup>	8.0...9.0 mm

<sup>1)</sup> Solid leads

### Produkt Strichzeichnungen (vermasst)

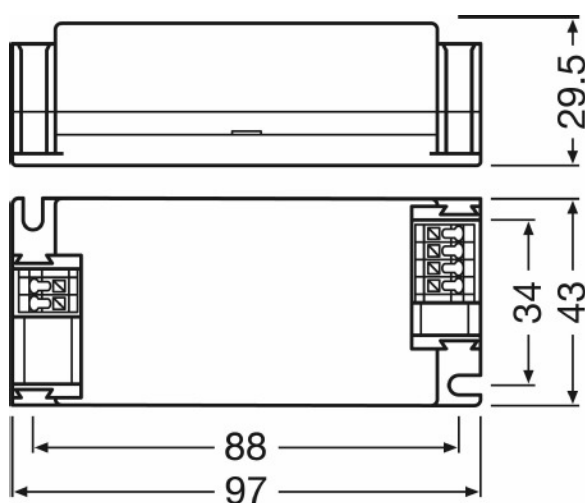

Product line drawing  
OTe 25/220...240/420 CS

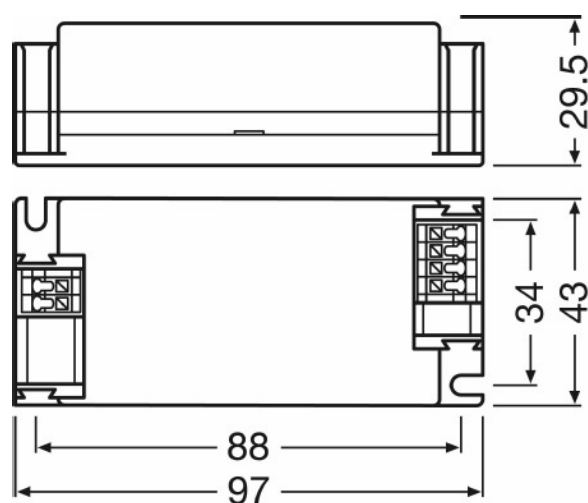

Product line drawing  
OTe 25/220...240/700 CS

Product family datasheet

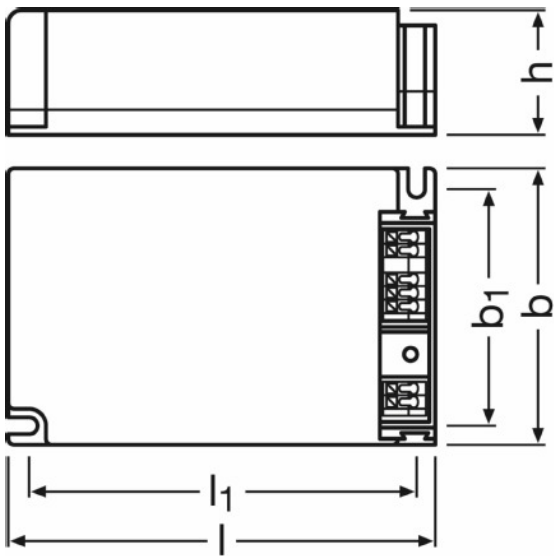

Product line drawing  
 OTe 35/220...240/700 CS | OTe 35/220...240/1A0 CS | OTe  
 50/220...240/1A0 CS | OTe 50/220...240/1A4 CS | OTe  
 50/220...240/1A0 CS FAN

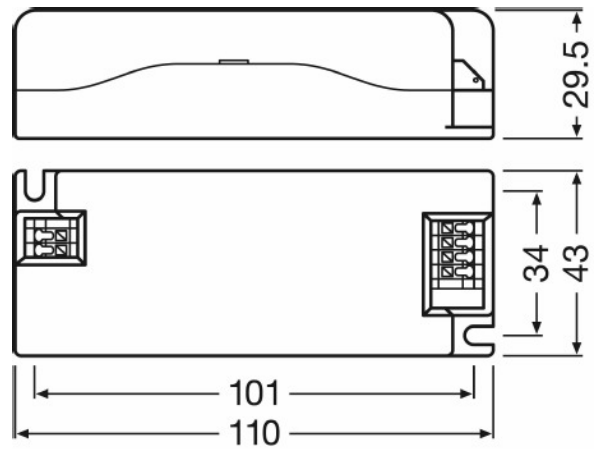

Product line drawing  
 OTe 35/220...240/700 CS S

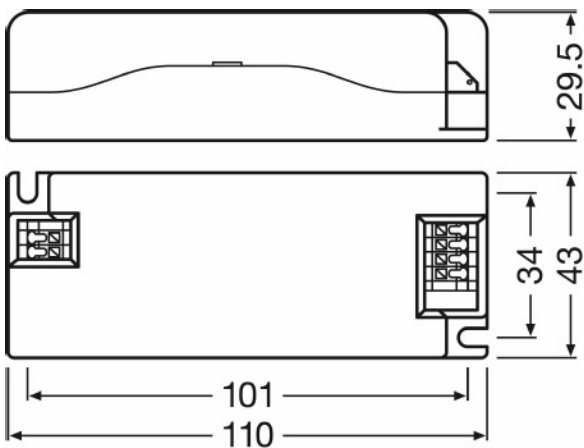

Product line drawing  
 OTe 35/220...240/1A0 CS S

# Product family datasheet

## Temperatures

Product description	Ambient temperature range	Maximum temperature at tc test point	Max.housing temperature in case of fault
OTe 25/220...240/420 CS	-20...+50 °C	75 °C <sup>1)</sup>	110 °C
OTe 25/220...240/700 CS	-20...+50 °C	75 °C <sup>1)</sup>	110 °C
OTe 35/220...240/700 CS	-20...+55 °C	75 °C <sup>1)</sup>	110 °C
OTe 35/220...240/700 CS S	-20...+50 °C	80 °C <sup>1)</sup>	110 °C
OTe 35/220...240/1A0 CS	-20...+55 °C	80 °C <sup>1)</sup>	110 °C
OTe 35/220...240/1A0 CS S	-20...+50 °C	80 °C <sup>1)</sup>	110 °C
OTe 50/220...240/1A0 CS	-20...+50 °C	85 °C <sup>1)</sup>	110 °C
OTe 50/220...240/1A4 CS	-20...+50 °C	80 °C <sup>1)</sup>	110 °C
OTe 50/220...240/1A0 CS FAN	-20...+50 °C	95 °C <sup>1)</sup>	110 °C

<sup>1)</sup> Maximum at the Tc-point

## Lifespan

Product description	ECG lifetime
OTe 25/220...240/420 CS	50000 h <sup>1)</sup>
OTe 25/220...240/700 CS	50000 h <sup>2)</sup>
OTe 35/220...240/700 CS	50000 h <sup>1)</sup>
OTe 35/220...240/700 CS S	50000 h <sup>2)</sup>
OTe 35/220...240/1A0 CS	50000 h <sup>2)</sup>
OTe 35/220...240/1A0 CS S	50000 h <sup>2)</sup>
OTe 50/220...240/1A0 CS	50000 h <sup>3)</sup>
OTe 50/220...240/1A4 CS	50000 h <sup>2)</sup>
OTe 50/220...240/1A0 CS FAN	50000 h <sup>4)</sup>

<sup>1)</sup> At tcase = 65°C at tc point / 10 % failure rate

<sup>2)</sup> At tcase = 70°C at tc point / 10 % failure rate

<sup>3)</sup> At tcase = 75°C at tc point / 10 % failure rate

<sup>4)</sup> At tcase = 85°C at tc point / 10 % failure rate

## Capabilities

Product description	Dimmable	Suitable for fixtures with prot. class	Overheating protection	Overload protection
OTe 25/220...240/420 CS	No	I / II	Automatic reversible	Automatic reversible
OTe 25/220...240/700 CS	No	I / II	Automatic reversible	Automatic reversible

## Product family datasheet

Product description	Dimmable	Suitable for fixtures with prot. class	Overheating protection	Overload protection
OTe 35/220...240/700 CS	No	I / II	Automatic reversible	Automatic reversible
OTe 35/220...240/700 CS S	No	I / II	Automatic reversible	Automatic reversible
OTe 35/220...240/1A0 CS	No	I / II	Automatic reversible	Automatic reversible
OTe 35/220...240/1A0 CS S	No	I / II	Automatic reversible	Automatic reversible
OTe 50/220...240/1A0 CS	No	I / II	Automatic reversible	Automatic reversible
OTe 50/220...240/1A4 CS	No	I / II	Automatic reversible	Automatic reversible
OTe 50/220...240/1A0 CS FAN	No	I / II	Automatic reversible	Automatic reversible

Product description	Short-circuit protection	No-load proof	Maximum wiring length ECG/lamp	NTC input
OTe 25/220...240/420 CS	Automatic reversible	Yes	2.0 m	
OTe 25/220...240/700 CS	Automatic reversible	Yes	2.0 m	
OTe 35/220...240/700 CS	Automatic reversible	Yes	2.0 m	
OTe 35/220...240/700 CS S	Automatic reversible	Yes	2.0 m	
OTe 35/220...240/1A0 CS	Automatic reversible	Yes	2.0 m	
OTe 35/220...240/1A0 CS S	Automatic reversible	Yes	2.0 m	
OTe 50/220...240/1A0 CS	Automatic reversible	Yes	2.0 m	
OTe 50/220...240/1A4 CS	Automatic reversible	Yes	2.0 m	
OTe 50/220...240/1A0 CS FAN	Automatic reversible		2.0 m	No

## Certificates & standards

Product description	Type of protection	Standards	Approval marks – approval
OTe 25/220...240/420 CS	IP20	acc. to IEC 61347-1/acc. to IEC 61347-2-13/acc. to IEC 62384/acc. to CISPR 15/acc. to IEC 61000-3-2/acc. to IEC 61547/acc. to IEC 61000-3-3	ENEC 10 / VDE / CE
OTe 25/220...240/700 CS	IP20	acc. to IEC 61347-1/acc. to IEC 61347-2-13/acc. to IEC 62384/acc. to CISPR 15/acc. to IEC 61000-3-2/acc. to IEC 61547/acc. to IEC 61000-3-3	ENEC 10 / VDE / CE

## Product family datasheet

Product description	Type of protection	Standards	Approval marks – approval
OTe 35/220...240/700 CS	IP20	acc. to IEC 61347-1/acc. to IEC 61347-2-13/acc. to IEC 62384/acc. to CISPR 15/acc. to IEC 61000-3-2/acc. to IEC 61547/acc. to IEC 61000-3-3	ENEC 10 / VDE / CE
OTe 35/220...240/700 CS S	IP20	acc. to IEC 61347-1/acc. to IEC 61347-2-13/acc. to IEC 62384/acc. to CISPR 15/acc. to IEC 61000-3-2/acc. to IEC 61547/acc. to IEC 61000-3-3	ENEC 10 / VDE / CE
OTe 35/220...240/1A0 CS	IP20	acc. to IEC 61347-1/acc. to IEC 61347-2-13/acc. to IEC 62384/acc. to CISPR 15/acc. to IEC 61000-3-2/acc. to IEC 61547/acc. to IEC 61000-3-3	ENEC 10 / VDE / CE
OTe 35/220...240/1A0 CS S	IP20	acc. to IEC 61347-1/acc. to IEC 61347-2-13/acc. to IEC 62384/acc. to CISPR 15/acc. to IEC 61000-3-2/acc. to IEC 61547/acc. to IEC 61000-3-3	ENEC 10 / VDE / CE
OTe 50/220...240/1A0 CS	IP20	acc. to IEC 61347-1/acc. to IEC 61347-2-13/acc. to IEC 62384/acc. to CISPR 15/acc. to IEC 61000-3-2/acc. to IEC 61547/acc. to IEC 61000-3-3	ENEC 10 / VDE / CE
OTe 50/220...240/1A4 CS	IP20	acc. to IEC 61347-1/acc. to IEC 61347-2-13/acc. to IEC 62384/acc. to CISPR 15/acc. to IEC 61000-3-2/acc. to IEC 61547/acc. to IEC 61000-3-3	ENEC 10 / VDE / CE
OTe 50/220...240/1A0 CS FAN	IP20	acc. to EN 61347-1/acc. to EN 61347-2-13/acc. to IEC 62384/acc. to CISPR 15/acc. to IEC 61000-3-2/acc. to IEC 61000-3-3/acc. to IEC 61547	ENEC 10 / VDE / CE

## Application advice



## Product family datasheet

For more detailed application information and graphics please see product datasheet.

---

### Sales and Technical Support



















---

Sales and Technical Support [www.osram.com](http://www.osram.com)

---

### Download Data

---

File	
	Product Datasheet OT Technical DS OTe 25_420 CS
	Declarations of conformity EC-DoC OTe CS
	CAD data OTe 25 CS-cable clamp-3D drawing
	CAD data 3-dim OTe 25 CS-housing-3D drawing
	CAD data 3-dim OTe 25 CS-housing with cable clamp-3D drawing
	Product Datasheet OT Technical DS OTe 25_700 CS
	Product Datasheet OT Technical DS OTe 35_700 CS
	CAD data 3-dim OTe 35 CS-cable clamp-3D drawing
	CAD data 3-dim OTe 35 CS-housing-3D drawing
	Product Datasheet OT Technical DS OTe 35_700 CS S
	CAD data 3-dim OTe 35 CS S-housing-3D drawing
	Product Datasheet OT Technical DS OTe 35_1A0 CS
	Product Datasheet OT Technical DS OTe 35_1A0 CS S
	Product Datasheet OT Technical DS OTe 50_1A0 CS
	CAD data 3-dim OTe 50 CS-cable clamp-3D drawing
	CAD data 3-dim OTe 50 CS-housing-3D drawing
	CAD data 3-dim OTe 50 CS-housing with cable clamp-3D drawing
	Product Datasheet

## Product family datasheet

OT Technical DS OTe 50\_1A4 CS



Product Datasheet  
OT Technical DS OTe 50220-2401A0 CS FAN

### Logistical Data

Product code	Product description	Packaging unit (Pieces/Unit)	Dimensions (height x width x length)	Volume	Gross weight
4052899917538	OTe 25/220...240/420 CS	Shipping carton box 20	- x - x -		
4052899917545	OTe 25/220...240/700 CS	Shipping carton box 20	- x - x -		
4052899917569	OTe 35/220...240/700 CS	Shipping carton box 20	- x - x -		
4052899917552	OTe 35/220...240/700 CS S	Shipping carton box 20	- x - x -		
4052899917668	OTe 35/220...240/1A0 CS	Shipping carton box 20	- x - x -		
4052899917651	OTe 35/220...240/1A0 CS S	Shipping carton box 20	- x - x -		
4052899917576	OTe 50/220...240/1A0 CS	Shipping carton box 20	- x - x -		
4052899917583	OTe 50/220...240/1A4 CS	Shipping carton box 20	- x - x -		
4052899919396	OTe 50/220...240/1A0 CS FAN	Shipping carton box 20	- x - x -		

The mentioned product code describes the smallest quantity unit which can be ordered. One shipping unit can contain one or more single products. When placing an order, for the quantity please enter single or multiples of a shipping unit.

### Disclaimer

Subject to change without notice. Errors and omission excepted. Always make sure to use the most recent release.

## X-ON Electronics

Largest Supplier of Electrical and Electronic Components

*Click to view similar products for [osram](#) manufacturer:*

Other Similar products are found below :

[LO L296-Q2S1-24-Z](#) [IPD2131-27](#) [GW PSLPS1.EC-KSKU-5R8T-1](#) [418962A](#) [LCW JNSH.PC-CPCR-5H7I-1](#) [LE RTDUW S2W](#) [LT A67C-S2U1-35](#) [BPW 34 FASR](#) [BPW 34 FSR](#) [BPW 34 SR](#) [LT A67C-T2V1-35](#) [GY CSHPM1.23-KQKS-36-0](#) [KW H5L531.TE-Z7R7-EBVFFCBB46-RS5R](#) [4058075097421](#) [79675](#) [79632](#) [OT 40/220-240/24 DIM P](#) [OT 60/220-240/24 DIM P](#) [OT 100/220-240/24 DIM P](#) [OT FIT 45/220-240/200 D L](#) [KW2 HIL532.TK-D2D9-4L07M0-SC6B](#) [LW TWTG.BB-BXCX-2B2C-1](#) [LA E6SF-BBCB-24-1-Z](#) [HDSP2112S](#) [LY E6SF-AABA-46-1-Z](#) [64760](#) [SFH 4715A-CBDA](#) [4058075097360](#) [4058075097544](#) [47659](#) [OT 6/200-240/24 CE](#) [OT FIT 35/220-240/350 D CS](#) [L](#) [OT FIT 8/220-240/180 CS S MINI](#) [64150ULT](#) [79366](#) [4052899917583](#) [4058075819658](#) [GW CSSRM2.PM-N3N5-XX51-1](#) [ELEMENT 90/220-240/24](#) [OT 40/220-240/24 P](#) [OT 60/220-240/24 P](#) [ELEMENT 6/220-240/150 S](#) [64210CBI](#) [LY E67F-ABBB-46-1-Z](#) [LS T670-J1K2-1-Z](#) [LO L29K-H2L1-24-Z](#) [LY E67B-T2V1-26-1-Z](#) [SFH 309 FA-5/6](#) [LE B Q8WP-8A7B-24](#) [51600](#)