

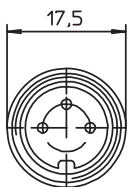

033099
SV

033098
SV ...-8

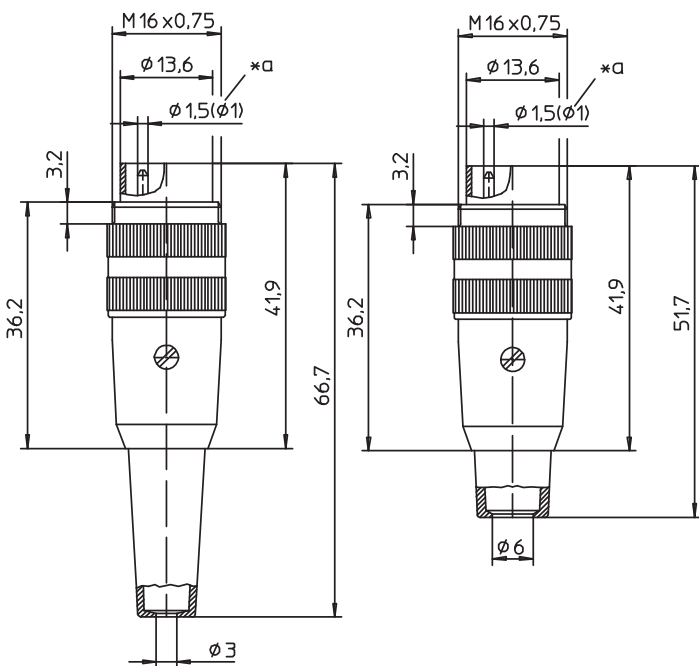

033099	SV
033098	SV ...-8

Stecker nach IEC 61076-2-106, IP 40, gerade, mit Schraubverschluss, Massekontakt und Lötanschlüssen
 033099, SV: mit langer Knickschutzülle
 033098, SV ...-8: mit kurzer Knickschutzülle

1. Temperaturbereich	-40 °C/+85 °C
2. Werkstoffe	
Kontaktträger	PA GF
Kontaktstift 3- bis 8-polig	CuZn, versilbert und flashvergoldet
Kontaktstift 12-polig	CuZn, unternickelt und vergoldet
Hülse	PC
Erdungsfahne	CuZn, unternickelt und verzinkt
Gehäuse 0330...	CuZn, vernickelt
Gehäuse SV	CuZn, vernickelt (veloursvernickelt)
Rändelschraube	CuZn, vernickelt
Knickschutzülle	TPE
Zugentlastung	Stahl, vernickelt
Schraube	Stahl, vernickelt

3. Mechanische Daten	
Kontaktierung mit	Kupplungen 032098, 032099, KFR, KfV, KGR, KGV, KV, WKV Kupplungen nach IEC 61076-2-106 und IEC 60130-9 IP 40
Schutzart ¹	IP 40
Weiteres siehe Tabelle	

4. Elektrische Daten	
Weiteres siehe Tabelle	

¹ nach DIN EN 60529, nur in verschraubtem Zustand mit einem dazugehörigen Gegenstück
² nach VDE 0110/IEC 60664

*a 12-polige Ausführung Ø 1,0 mm
 12 pole version Ø 1.0 mm
 version à 12 pôles Ø 1,0 mm

Polbilder, von der Lötseite gesehen
 Pin configurations, solder side view
 Schémas de raccordement, vus du côté à souder

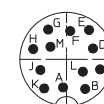
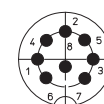
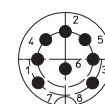
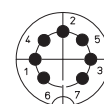
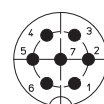
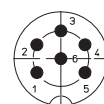
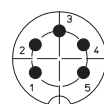
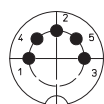
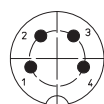
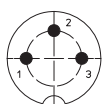

0330... 03
SV 30

0330... 04
SV 40

0330... 05
SV 50

0330... 05-1
SV 50/6

0330... 06
SV 60

0330... 07
SV 70

0330... 07-1
SV 71

0330... 08
SV 80

0330... 08-1
SV 81

0330... 12
SV 120

Rundsteckverbinder mit Schraubverschluss nach IEC 61076-2-106, IP 40
Circular connectors with threaded joint acc. to IEC 61076-2-106, IP 40
Connecteurs circulaires avec verrouillage à vis suivant CEI 61076-2-106, IP 40

033099	SV
033098	SV ...-8
Plug acc. to IEC 61076-2-106, IP 40, straight, with threaded joint, ground contact and solder terminals	
033099, SV: with long bend protection	
033098, SV ...-8: with short bend protection	
1. Temperature range	-40 °C/+85 °C
2. Materials	
Insulating body	PA GF
Contact pin 3 to 8 poles	CuZn, silvered and flash gilded
Contact pin 12 poles	CuZn, pre-nickeled and gilded
Sleeve	PC
Grounding spring	CuZn, pre-nickeled and tinned
Housing 0330...	CuZn, nicked
Housing SV	CuZn, nicked (velour nicked)
Knurled screw	CuZn, nicked
Bend protection	TPE
Strain relief	steel, nicked
Screw	steel, nicked
3. Mechanical data	
Mating with	sockets 032098, 032099, KFR, KFV, KGR, KGV, KV, WKV sockets according to IEC 61076-2-106 and IEC 60130-9
Protection ¹	IP 40
For further information see table	
4. Electrical data	
For further information see table	
¹	according to DIN EN 60529, only in locked position with a proper counterpart
²	according to VDE 0110/IEC 60664

033099	SV
033098	SV ...-8
Connecteur mâle suivant CEI 61076-2-106, IP 40, droite, avec verrouillage à vis, contact de masse et connexion par soudeure	
033099, SV: avec un long protecteur contre pliage	
033098, SV ...-8: avec un court protecteur contre pliage	
1. Température d'utilisation	-40 °C/+85 °C
2. Matériaux	
Corps isolant	PA GF
Contact à broche 3 à 8 pôles	CuZn, argenté et doré flash
Contact à broche 12 pôles	CuZn, sous-nickelé et doré
Douille	PC
Ressort de terre	CuZn, sous-nickelé et étamé
Boîtier 0330...	CuZn, nickelé
Boîtier SV	CuZn, nickelé (de velours)
Vis moletée	CuZn, nickelé
Protection contre pliage	TPE
Décharge de traction	acier, nickelé
Vis	acier, nickelé
3. Caractéristiques mécaniques	
Raccordement avec	connecteurs femelles 032098, 032099, KFR, KFV, KGR, KGV, KV, WKV
Protection ¹	connecteurs femelles suivant CEI 61076-2-106 et CEI 60130-9
IP 40	
Pour plus de détails, voir tableau	
4. Caractéristiques électriques	
Pour plus de détails, voir tableau	
¹	suitant DIN EN 60529, uniquement à l'état verrouillé avec un propre pendant
²	suitant VDE 0110/CEI 60664

Bestellbezeichnung Designation Désignation	Polzahl Pôles Pôles	Verpackungseinheit (VE) Package unit (PU) Unité d'emballage (UE)	Anschlussquerschnitt Wire section Section de racc. de fil	Kabeldurchmesser Cable diameter Diamètre de cable	Bemessungsstrom Rated current Courant assigné	Bemessungsspannung ² Rated voltage ² Tension assignée ²	Prüfspannung Test voltage Tension d'essai	Isolationswiderstand Insulation resistance Résistance d'isolement	Kontaktkapazität Contact capacitance Capacité de contact	
			mm ²	mm	A	V AC	kV AC eff.	GΩ	pF	
033099 03	SV 30	3	50	0,75	4-6	5	250	2	> 10	~ 2
033098 03	SV 30-8	3	50	0,75	6-8	5	250	2	> 10	~ 2
033099 04	SV 40	4	50	0,75	4-6	5	250	2	> 10	~ 2
033098 04	SV 40-8	4	50	0,75	6-8	5	250	2	> 10	~ 2
033099 05	SV 50	5	50	0,75	4-6	5	60	1	> 10	~ 3
033098 05	SV 50-8	5	50	0,75	6-8	5	60	1	> 10	~ 3
033099 05-1	SV 50/6	5	50	0,75	4-6	5	250	2	> 10	~ 2
033098 05-1	SV 50/6-8	5	50	0,75	6-8	5	250	2	> 10	~ 2
033099 06	SV 60	6	50	0,75	4-6	5	250	2	> 10	~ 2
033098 06	SV 60-8	6	50	0,75	6-8	5	250	2	> 10	~ 2
033099 07	SV 70	7	50	0,75	4-6	5	250	2	> 10	~ 2
033098 07	SV 70-8	7	50	0,75	6-8	5	250	2	> 10	~ 2
033099 07-1	SV 71	7	50	0,75	4-6	5	60	1	> 10	~ 3
033098 07-1	SV 71-8	7	50	0,75	6-8	5	60	1	> 10	~ 3
033099 08	SV 80	8	50	0,75	4-6	5	60	1	> 10	~ 3
033098 08	SV 80-8	8	50	0,75	6-8	5	60	1	> 10	~ 3
033099 08-1	SV 81	8	50	0,75	4-6	5	60	1	> 10	~ 3
033098 08-1	SV 81-8	8	50	0,75	6-8	5	60	1	> 10	~ 3
033099 12	SV 120	12	50	0,25	4-6	3	60	1	> 10	~ 3
033098 12	SV 120-8	12	50	0,25	6-8	3	60	1	> 10	~ 3

Verpackung: im Karton
 Packaging: in a cardboard box
 Emballage: dans un carton

X-ON Electronics

Largest Supplier of Electrical and Electronic Components

Click to view similar products for [Circular Metric Connectors](#) category:

Click to view products by [Lumberg](#) manufacturer:

Other Similar products are found below :

[1424048](#) [1021212](#) [600X518037X](#) [6STD09SAM99B70X](#) [6STD15PCR99B70A](#) [8R4000A16M020](#) [1200910002](#) [1201150041](#) [1203580030](#)
[1200700064](#) [1200700263](#) [1200700416](#) [1200730102](#) [1200770002](#) [1-2823588-2](#) [130203-0054](#) [1300140026](#) [1300150099](#) [1-3637-600-5205](#)
[1545399](#) [1594331](#) [1600413](#) [1612606](#) [1612618](#) [1614660](#) [1A4000-348](#) [CA06EW24-10P-B-03](#) [21036836414](#) [2823064-1](#) [1610759](#) [A1642LK-](#)
[II-T](#) [1R3006A20M005](#) [41-01016](#) [41-40011](#) [41-40017](#) [42-00006](#) [42-01015](#) [4-22279-4](#) [4-22281-1](#) [4-22284-9](#) [43-00002](#) [43-00113](#) [43-00130](#)
[43-01028](#) [43-01034](#) [43-01088](#) [43-01090](#) [43-01203](#) [43-01209](#) [43-01335](#)