



Relays with forcibly  
guided contacts



# Product Catalogue



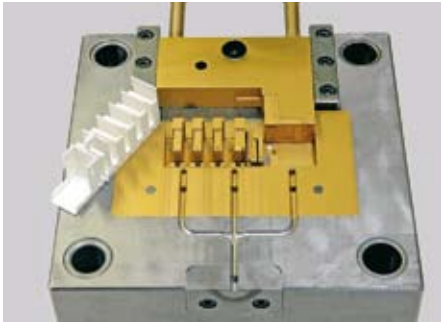

Injection moulding die



Coil fabrication



Assembly station

### ***The company***

ELESTA relays GmbH established in the Swiss town of Bad Ragaz is one of the leading producers in the field of safety relays with forcibly guided contacts. A very comprehensive programme of safety relays enables ELESTA relays to offer the right product for just about all application areas.

Specializing in relays with forcibly guided contacts, ELESTA relays impresses its customers and the market over and over again with innovation which sets distinct benchmarks in the world of safety relays.

### ***Products***

Relays made by ELESTA are used in safety applications all over the world. The application areas are highly diverse and range from e.g. emergency-off switching devices over transport systems (lifts, escalators, etc.) right to complex machine controls. The focus is on ELESTA relays wherever humans and expensive equipment need to be protected from injuries and damage, respectively.

ELESTA relays attaches great importance to quality. With a rigid quality programme applied during the entire production process and 100% inspection before delivery we combine "Safety without compromises" and "Quality without compromises".

Depending on the type of relay, our production sequences are fully or partly automated, whereby highest quality is also guaranteed in the few manual operations. All products are made exclusively at our factory in Bad Ragaz, Switzerland.

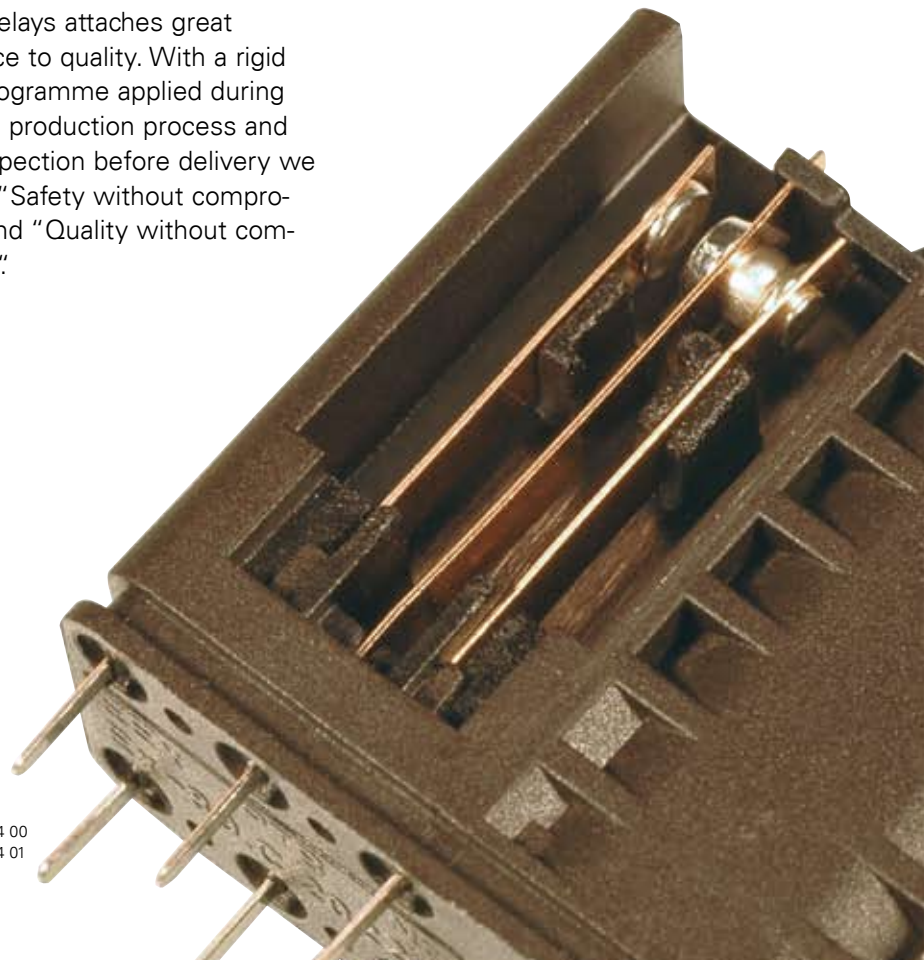

# *in performance and safety*

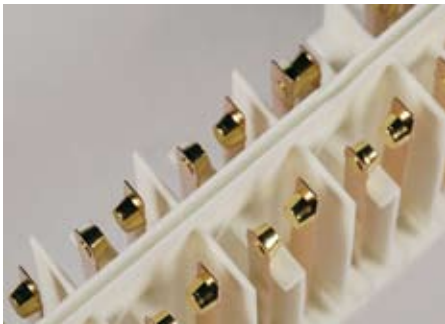

Set of contacts



Set of contacts with actuator

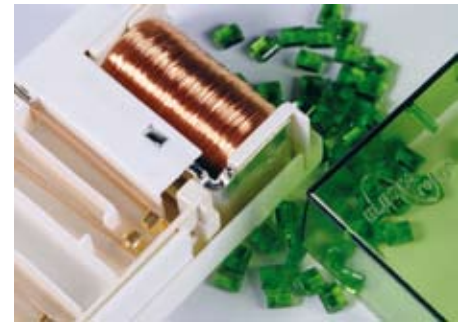

Open relay

## **Customer value**

With ELESTA relays, however, the high quality is not only reflected in the products. Our maxim must stand up to highest demands also in the close cooperation with our customers. The majority of our deliveries, for example, are shipped within one week from receipt of the order, and we promise to deal with your technical enquiries within 24 hours.

An intensive cooperation with our customers is very important to us. Our specialists are ready to support you in the choice of the correct relays for your application, train your personnel in matters of safety relays and make their know-how available to you in complex cases.

## **Safety requirements**

Relays with forcibly guided contacts are used in safety-oriented applications for the decoupling of different voltage potentials. These relays permit implementation of self-monitoring systems. Complying with the European standard EN50205, a relay with forcibly guided contacts consists of at least one N.C. and one N.O. contact. Break and make contact must never be closed at the same time during the entire life of the relay. In case of a fault the contact gap must be at least 0.5 mm. Additionally, the insulation values are subject to higher standards and pollution degree 2 is defined for relays with forcibly guided contacts. For the contact spring assemblies and other conducting parts in the relay it must be ensured that no short circuits or conducting connections result in case such parts should ever fracture or become loose.

## **Our strengths**

As an acknowledged specialist in the production of relays with forcibly guided contacts ELESTA relays offers its customers a comprehensive range covering virtually all application cases. Permanent observation of the market, the participation in standardization committees and a close cooperation with suppliers, research institutions and directly with the users enable us to offer our clientele innovative products to suit their requirements in good time. With our outstanding customer support, high flexibility and on time deliveries we provide the services which buyers of such products rightly expect. Our strengths are:

- Relays for switching currents from 5mA to 16A
- 2 to 10 contacts
- Minimum coil capacities
- Minimum space requirements
- Wide coil working ranges
- High insulation values
- Customized relay variants
- RoHS-conforming and safe at higher solder process temperatures
- Reliable and rapid support
- Short delivery times

All statements made in this catalogue are believed to be true and are not legally binding. We reserve the right to make technical alterations.



**SIS 2 Contacts** *page 6*

- PCB relay with forcibly guided contacts and protective separation between coil/control contact and output contacts (> 10mm).
- 2 contacts for 5mA...6A

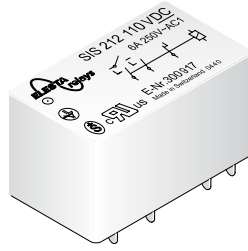

**SIS 3 Contacts** *page 7-8*

- SIS 3 Contacts sensitive**
- PCB relay with forcibly guided contacts and protective separation between coil/control contact and output contacts (> 8mm).
- 3 contacts for 5mA...6A



**SIS 4 Contacts** *page 9*

- PCB relay with forcibly guided contacts and protective separation between coil/control contacts and output contacts (> 8mm) and output contacts in one row (> 5.5mm).
- 4 contacts for 5mA...6A



**SGR282Z (2 CO)** *page 13-14*

- SGR282Z (2 CO) sensitive**
- PCB relay with forcibly guided contacts and protective separation between coil and contacts (leakage and creepage distance > 14mm); protective separation between the contacts facing each other
- 2 change-over contacts for 10mA...6A



**SIR282 (2 CO)** *page 15-16*

- SIR282 (2 CO) sensitive**
- PCB relay with forcibly guided contacts and protective separation between coil and contacts (leakage and creepage distance > 14mm); protective separation between the contacts facing each other
- 2 change-over contacts for 10mA...8A



**SIM 2 Contacts** *page 17*

- PCB relay with forcibly guided contacts and protective separation between coil and contacts (leakage and creeping distances > 14mm); protective separation between left and right contact side (leakage and creeping distances > 5.5mm)
- 2 contacts for 10mA...8A



**SIR 4 Contacts** *page 21-23*

- SIR 4 Contacts sensitive**
- SIR 4 Contacts „Power“**
- PCB relay with forcibly guided contacts and protective separation between coil/control contacts and output contacts (> 10mm) as well as protective separation between the output contacts themselves (> 8mm)
- 4 contacts for 10mA...10A



**SIR 6 Contacts** *page 24-25*

- SIR 6 Contacts sensitive**
- PCB relay with forcibly guided contacts and protective separation between coil/control contacts and output contacts (> 10mm) as well as protective separation between the output contacts themselves (> 8mm)
- 6 contacts for 10mA...10A



**SIR 8 Contacts** *page 26*

- PCB relay with forcibly guided contacts and protective separation between coil/contacts (> 10mm) and contacts in one row (> 8mm) and as left to right contact side (> 10mm)
- 8 contacts for 10mA...10A

# *multifunctional and safety*



**SIS 6 Contacts** *page 10*

- PCB relay with forcibly guided contacts and protective separation between coil/control contacts and output contacts (> 8mm) and output contacts in one row (> 5.5mm).
- 6 contacts for 5mA...6A



**SIF 4 Contacts** *page 11*

- PCB relay with forcibly guided contacts and protective separation between coil/contacts (> 5.5mm) and contacts side by side (> 5.5mm)
- 4 contacts for 5mA...8A



**SIF 6 Contacts** *page 12*

- PCB relay with forcibly guided contacts and protective separation between coil/contacts (> 5.5mm) and contacts side by side (> 5.5mm)
- 6 contacts for 5mA...8A



**SIM 3 Contacts** *page 18*

- PCB relay with forcibly guided contacts and protective separation between coil and contacts (leakage and creeping distances > 14mm); protective separation between left and right contact side (leakage and creeping distances > 5.5mm)
- 3 contacts for 10mA...8A



**SIM 4 Contacts** *page 19*

- PCB relay with forcibly guided contacts and protective separation between coil and contacts (leakage and creeping distances > 14mm); protective separation between left and right contact side (leakage and creeping distances > 5.5mm)
- 4 contacts for 10mA...8A



**SLR 4 Contacts** *page 20*

- PCB relay with forcibly guided contacts and protective separation between coil/control contacts and output contacts (> 8mm) as well as protective separation between the output contacts themselves (> 10mm)
- 4 contacts for 10mA...10A



**SIR 10 Contacts** *page 27*

- PCB relay with forcibly guided contacts and protective separation between coil/control contacts and output contacts (> 8mm) and output contacts in one row (> 8mm) and as left to right contact side (> 10mm)
- 10 contacts for 10mA...10A



**SIP 6 Contacts** *page 28*

- PCB relay with forcibly guided contacts and protective separation between coil/control contacts and output contacts (> 8mm) and output contacts in one row (> 8mm).
- 2 control contacts for 5mA...6A
- 4 output contacts for 10mA...16A



**Accessories** *page 29-32*

- Plug sockets for print assembly or DIN rail assembly and module

**Certificates** *page 33-35*



## Relay data

- PCB relay with forcibly guided contacts
- Protective separation between control and load circuit (leakage and creepage distances > 10mm)
- EN 50205, type A
- Double and reinforced insulation between the contacts
- Contact mounting: SIS112 1NO/1NC
- Small external dimensions
- Mean coil power 0.27W
- Holding power 0.08 W
- for Railway Applications: EN 50155

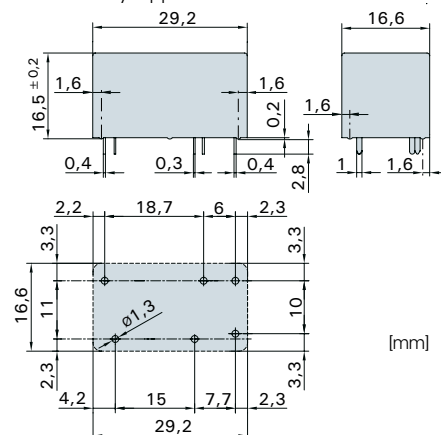

Contact material	AgCuNi+0,2-0,4µm Au
Type of contact	Single contact with notched crown
Rated switching capacity	250VAC 6A AC1 1'500VA
Electr. life AC1 (360 cycles/h)	approx. 100'000
Inrush current max.	30A for 20ms
Switching voltage range	5 to 250VDC/VAC
Switching current range*	5mA to 6A
Switching capacity range*	60mW to 1'500W (VA)
Contact resistance (as delivered)	≤100mΩ /28V/100 mA

\* Guide values

### Standard coils for direct current (other voltages on request)

Nominal voltage VDC	Min. pick-up voltage at 20°C	Drop-out voltage at 20 °C	Nominal current in mA	Resistance in Ohm at 20 °C	Tolerance in %
5	≤ 3,5	≥ 0,5	54,9	91	± 10
6	≤ 4,2	≥ 0,6	46,1	130	± 10
9	≤ 6,3	≥ 0,9	30,5	295	± 10
12	≤ 8,4	≥ 1,2	23,0	520	± 10
18	≤ 12,6	≥ 1,8	15,2	1'180	± 10
24	≤ 16,8	≥ 2,4	11,4	2'100	± 10
48	≤ 33,6	≥ 4,8	5,7	8'350	± 13
60	≤ 42,0	≥ 6,0	4,5	13'100	± 15

### Ordering example

SIS 1 1 2 24VDC

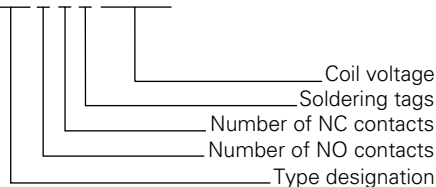

## General data

### Circuit diagram (view on relay upper side)

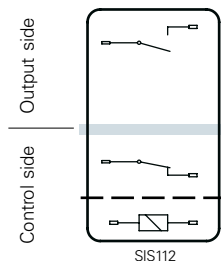

- - - Basic insulation
- Double or reinforced insulation

Mechanical life	> 10 x 10 <sup>6</sup> operations
Switching frequency, mechanical	15Hz
Response time (NO closed)	typically 10ms
Drop-out time** (NC closed)	typically 3ms
Bounce time of NO contact	typically 2ms
Bounce time of NC contact	typically 15ms
Shock resistance 16ms	NO contact 17g NC contact 7g
Vibration resistance 10-200Hz	NO contact 7g NC contact 2g
Test voltage coil/control contact	2'500Veff 1min
Test voltage coil-control contact/output contact	5'000Veff 1min
Test voltage contact open	1'500Veff 1min
Insulation resistance at Up 500V	10 <sup>8</sup> Ω
Creepage resistance	CTI 175
Weight	approx. 18g
Mounting position	any
Ambient temperature	-40°C to +70°C
Type of protection	RT III
Solder bath temperature	270°C/5s
Thermal resistance	55K/W
Temperature limit for coil	120°C
Pollution degree	2
Overvoltage category	III
Resistance to short circuiting	1'000A SCPD 6A gL/gG (pre-fuse)

\*\* without spark suppression

### Insulation terms

Coil to control contact:	Basic insulation
Coil/control contact to output contact:	Double or reinforced insulation > 10mm

### Tests, regulations

Approvals	SEV, UL, cUL, TÜV
UL File E188953	Sec. 5
Insulation class IEC 60664-1	250VAC
Protection class II	VDE 0106
Fire protection requirements	UL 94 / V0

## Diagrams

### Contact lifetime

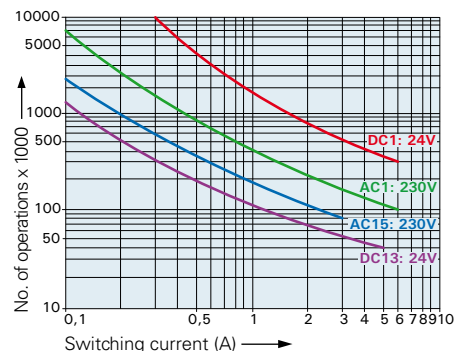

Max. switching characteristics (determined acc. to DIN EN 60947-4-1 / EN 60947-5-1):

- AC 1: 250V/6A
- AC 15: 230V/3A
- DC 1: 24V/6A
- DC 13: 24V/5A/0,1 Hz
- UL 508: B300 / R300

### Load limit curve with direct current

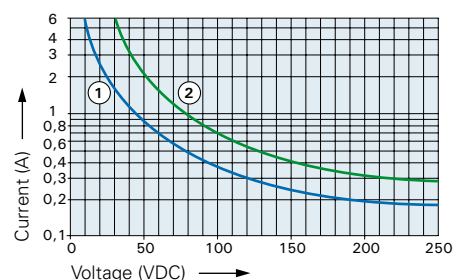

- 1) Inductive load, L/R 40 ms
- 2) Resistive load

### Excitation voltage range

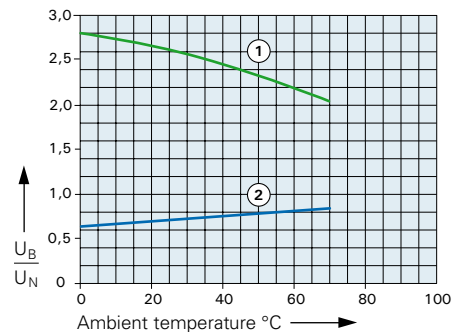

- 1) Max. excitation voltage with contact load ≤ 2A
- 2) Min. excitation voltage (guaranteed values) without previous operation

No heat accumulation due to intrinsic heating of other components.  
Continuous duty 100%.

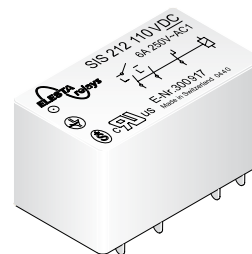

## Relay data

- PCB relay with forcibly guided contacts
- Protective separation between control and load circuit (leakage and creepage distance > 8mm)
- EN 50205, type A
- Double and reinforced insulation between the contacts
- Contact mounting: SIS212 2NO/1NC
- Small external dimensions
- Mean coil power 0.6W
- Holding power 0.18 W

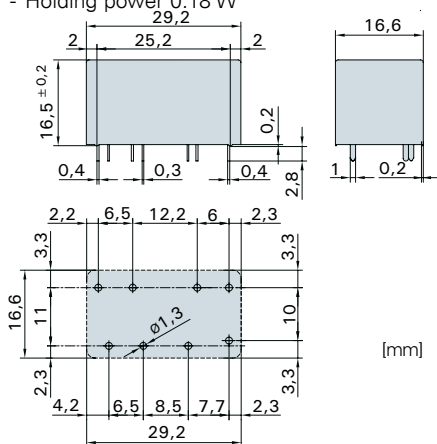

Contact material	AgCuNi+0.2-0.4µm Au
Type of contact	Single contact with notched crown
Rated switching capacity	250VAC 6A AC1 1'500VA
Electr. life AC1 (360 cycles/h)	approx. 100'000
Inrush current max.	30A for 20ms
Switching voltage range	5 to 250VDC/VAC
Switching current range*	5mA to 6A
Switching capacity range*	60mW to 1'500W (VA)
Contact resistance (as delivered)	≤ 100mΩ/28V/100mA

\* Guide values

### Standard coils for direct current (other voltages on request)

Nominal voltage VDC	Min. pick-up voltage at 20°C	Drop-out voltage at 20 °C	Nominal current in mA	Resistance in Ohm at 20 °C	Tolerance in %
5	≤ 3,5	≥ 0,5	120,0	41,5	± 10
9	≤ 6,3	≥ 0,9	66,6	135	± 10
12	≤ 8,4	≥ 1,2	50,0	240	± 10
18	≤ 12,6	≥ 1,8	33,3	540	± 10
24	≤ 16,8	≥ 2,4	25,0	960	± 10
48	≤ 33,6	≥ 4,8	12,5	3'840	± 10
60	≤ 42,0	≥ 6,0	10,0	6'000	± 13
110	≤ 77,0	≥ 11,0	5,4	20'150	± 15

### Ordering example

**SIS 2 1 2 24VDC**

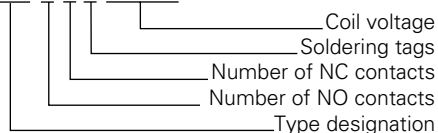

## General data

### Circuit diagram (view on relay upper side)

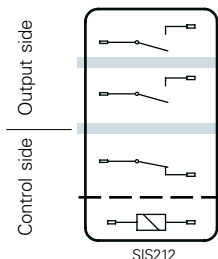

- - - Basic insulation
- ▬ Double or reinforced insulation

Mechanical life	> 10 x 10 <sup>6</sup> operations
Switching frequency, mechanical	15Hz
Response time (all NO closed)	typically 10ms
Drop-out time** (all NC closed)	typically 3ms
Bounce time of NO contact	typically 2ms
Bounce time of NC contact	typically 15ms
Shock resistance	16ms NO contact 17g NC contact 10g
Vibration resistance	10-200Hz NO contact 7g NC contact 3g
Test voltage coil/control contact	2'500Veff 1min
Test voltage output contacts as against each other	4'000Veff 1min
Test voltage contact open	1'500Veff 1min
Insulation resistance at U <sub>p</sub> 500V	10 <sup>8</sup> Ω
Creepage resistance	CTI 175
Weight	approx. 20g
Mounting position	any
Ambient temperature	-40°C to +70°C
Type of protection	RT III
Solder bath temperature	270°C/5s
Thermal resistance	55K/W
Temperature limit for coil	120°C
Pollution degree	2
Overvoltage category	III
Resistance to short circuiting	1'000A SCPD 6A gG (pre-fuse)

\*\* without spark suppression

### Insulation terms

Coil to control contact:	Basic insulation
Coil/control contact to output contacts:	Double or reinforced insulation > 8mm

### Tests, regulations

Approvals	SEV, UL, cUL, TÜV
UL File E188953	Sec. 5
Insulation class IEC 60664-1	250VAC
Protection class II	VDE 0106
Fire protection requirements	UL 94 / V0

## Diagrams

### Contact lifetime

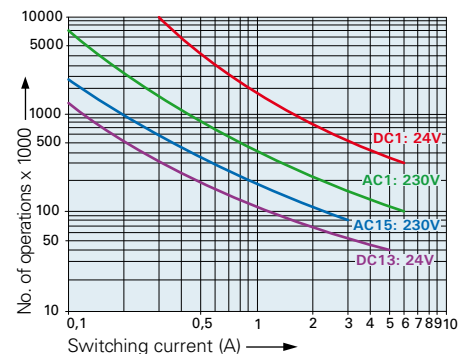

Max. switching characteristics (determined acc. to DIN EN 60947-4-1 / EN 60947-5-1):  
 AC 1: 250V/6A  
 AC 15: 230V/3A  
 DC 1: 24V/6A  
 DC 13: 24V/5A/0,1 Hz  
 UL 508: B300 / R300

Maximal contact load at AC 1 with 230V:  
 2 contacts each with 6A

### Load limit curve with direct current

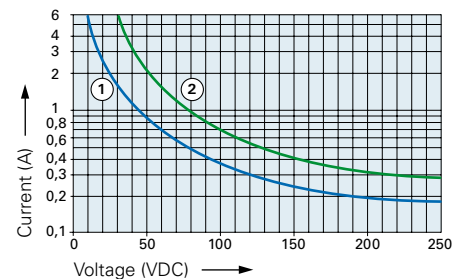

- 1) Inductive load, L/R 40 ms
- 2) Resistive load

### Excitation voltage range

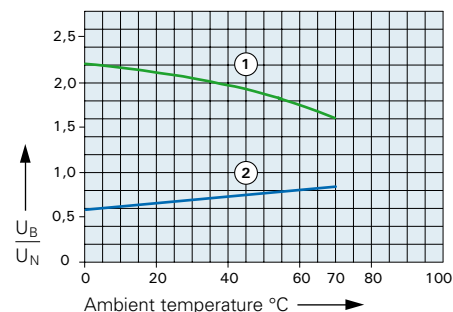

- 1) Max. excitation voltage with contact load ≤ 2A
- 2) Min. excitation voltage (guaranteed values) without previous operation

No heat accumulation due to intrinsic heating of other components.  
 Continuous duty 100%.

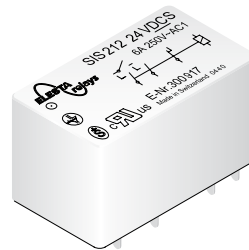

## Relay data

- PCB relay with forcibly guided contacts
- Protective separation between control and load circuit (leakage and creepage distance > 8mm)
- EN 50205, type A
- Double and reinforced insulation between the contacts
- Contact mounting: SIS212 2NO/1NC
- Small external dimensions
- Mean coil power 0.4W
- Holding power 0.14 W
- For Railway Applications: EN 50155

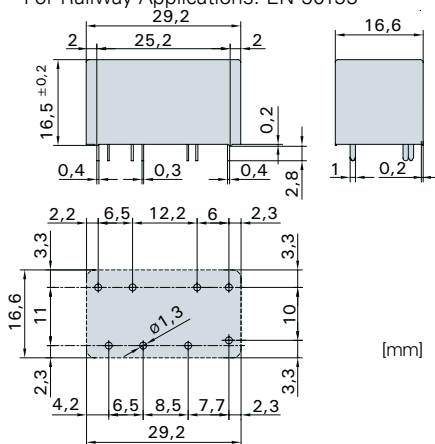

Contact material	AgCuNi+0.2-0.4µm Au
Type of contact	Single contact with notched crown
Rated switching capacity 250VAC 6A AC1	1'500VA
Electr. life AC1 (360 cycles/h)	approx. 100'000
Inrush current max.	30A for 20ms
Switching voltage range	5 to 250VDC/VAC
Switching current range*	5mA to 6A
Switching capacity range*	60mW to 1'500W (VA)
Contact resistance (as delivered)	<100mΩ / 28 V/100mA

\* Guide values

### Standard coils for direct current (other voltages on request)

Nominal voltage VDC	Min. pick-up voltage at 20°C	Drop-out voltage at 20 °C	Nominal current in mA	Resistance in Ohm at 20 °C	Tolerance in %
5	≤ 3,75	≥ 0,5	80,0	62,5	± 10
6	≤ 4,5	≥ 0,6	66,6	90	± 10
9	≤ 6,75	≥ 0,9	44,5	202	± 10
12	≤ 9,0	≥ 1,2	33,3	360	± 10
18	≤ 13,5	≥ 1,8	22,2	810	± 10
24	≤ 18,0	≥ 2,4	16,6	1'440	± 10
48	≤ 36,0	≥ 4,8	8,3	5'750	± 13
60	≤ 45,0	≥ 6,0	6,6	9'000	± 15

### Ordering example

**SIS 2 1 2 24VDC SEN**

- SIS: Type designation
- 2: Number of NO contacts
- 1: Number of NC contacts
- 24VDC: Coil voltage
- SEN: sensitive coil

## General data

### Circuit diagram (view on relay upper side)

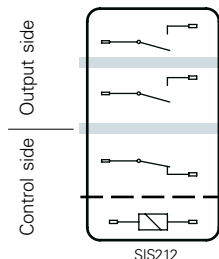

- - - Basic insulation
- ▬ Double or reinforced insulation

Mechanical life	> 10 x 10 <sup>6</sup> operations
Switching frequency, mechanical	15Hz
Response time (all NO closed)	typically 10ms
Drop-out time** (all NC closed)	typically 3ms
Bounce time of NO contact	typically 2ms
Bounce time of NC contact	typically 15ms
Shock resistance 16ms	NO contact 17g NC contact 10g
Vibration resistance 10-200Hz	NO contact 7g NC contact 3g
Test voltage coil/control contact	2'500Veff 1min
Test voltage output contacts as against each other	4'000Veff 1min
Test voltage contact open	1'500Veff 1min
Insulation resistance at U <sub>p</sub> 500V	10 <sup>8</sup> Ω
Creepage resistance	CTI 175
Weight	approx. 20g
Mounting position	any
Ambient temperature	-40°C to +70°C
Type of protection	RT III
Solder bath temperature	270°C/5s
Thermal resistance	55K/W
Temperature limit for coil	120°C
Pollution degree	2
Overvoltage category	III
Resistance to short circuiting	1'000A SCPD 6A gG (pre-fuse)

\*\* without spark suppression

### Insulation terms

Coil to control contact: Basic insulation  
Coil/control contact to output contacts: Double or reinforced insulation > 8mm

### Tests, regulations

Approvals	SEV, UL, cUL, TÜV
UL File E188953	Sec. 5
Insulation class IEC 60664-1	250VAC
Protection class II	VDE 0106
Fire protection requirements	UL 94 / V0

## Diagrams

### Contact lifetime

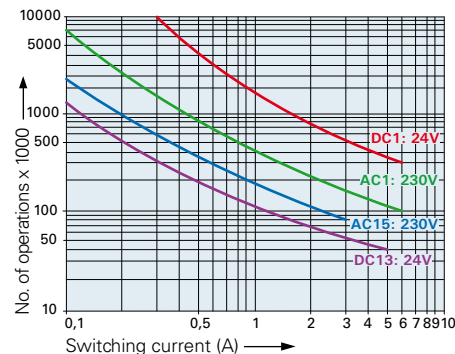

Max. switching characteristics (determined acc. to DIN EN 60947-4-1 / EN 60947-5-1):  
AC 1: 250V/6A  
AC 15: 230V/3A  
DC 1: 24V/6A  
DC 13: 24V/5A/0,1 Hz  
UL 508: B300 / R300

Maximal contact load at AC 1 with 230V: 2 contacts each with 6A

### Load limit curve with direct current

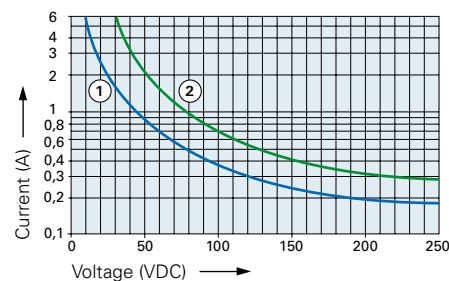

- 1) Inductive load, L/R 40 ms
- 2) Resistive load

### Excitation voltage range

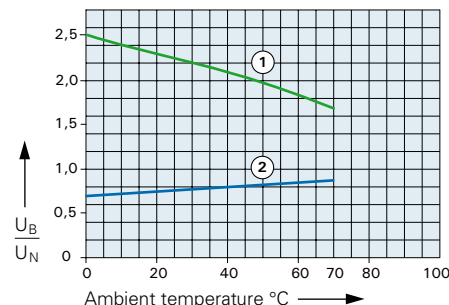

- 1) Max. excitation voltage with contact load ≤ 2A
- 2) Min. excitation voltage (guaranteed values) without previous operation

No heat accumulation due to intrinsic heating of other components.  
Continuous duty 100%.





## Relay data

- PCB relay with forcibly guided contacts
- Protective separation between control and load circuit (leakage and creepage distance > 8mm)
- EN 50205, type A
- Double and reinforced insulation between the contacts
- Contact mounting:  
SIS312 3NO/1NC SIS222 2NO/2NC
- Small external dimensions
- Mean coil power 0.5W
- Holding power 0.15 W
- For Railway Applications: EN 50155

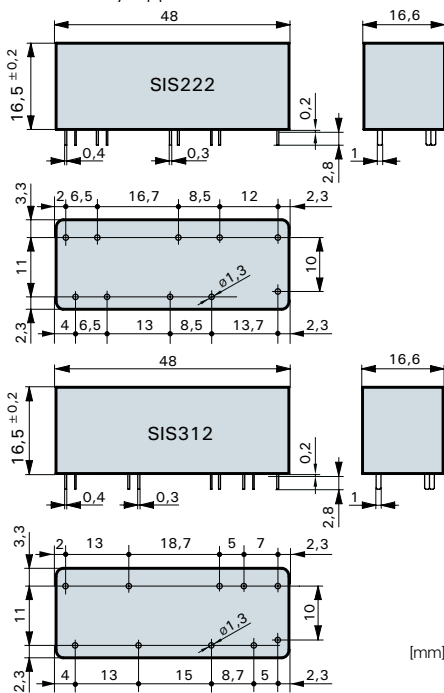

Contact material	AgCuNi+0,2-0,4µm Au
Type of contact	Single contact with notched crown
Rated switching capacity	250VAC 6A AC1 1'500VA
Electr. life AC1 (360 cycles/h)	approx. 100'000
Inrush current max.	30A for 20ms
Switching voltage range	5 to 250VDC/VAC
Switching current range*	5mA to 6A
Switching capacity range*	60mW to 1'500W (VA)
Contact resistance (as delivered)	≤100mΩ/28 V/100mA

\* Guide values

### Standard coils for direct current (other voltages on request)

Nominal voltage VDC	Min. pick-up voltage at 20°C	Drop-out voltage at 20°C	Nominal current in mA	Resistance in Ohm at 20°C	Tolerance in %
5	3,5	≥ 0,5	100	50	± 10
9	6,3	≥ 0,9	56,2	160	± 10
12	8,4	≥ 1,2	42,1	285	± 10
18	12,6	≥ 1,8	28,1	640	± 10
24	16,8	≥ 2,4	20,8	1'150	± 10
48	33,6	≥ 4,8	10,4	4'600	± 13
60	42,0	≥ 6,0	8,3	7'200	± 13
110	77,0	≥ 11,0	4,5	24'200	± 15

## General data

### Circuit diagram (view on relay upper side)

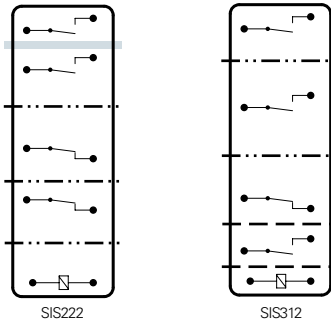

- Double or reinforced insulation for mains circuits  
> 8mm leakage distance,  
> 5,5mm creeping distance
- - - Double or reinforced insulation for safety low voltage  
> 8mm leakage and creeping distance
- - - Basic insulation  
> 4mm leakage and creeping distance

Mechanical life	> 10 x 10 <sup>6</sup> operations
Switching frequency, mechanical	15Hz
Response time (all NO closed) typically	15ms
Drop-out time** (all NC closed) typically	5ms
Bounce time of NO contact typically	2ms
Bounce time of NC contact typically	15ms
Shock resistance	16ms
	NO contact 10g
	NC contact 10g
Vibration resistant	10-200Hz
	NO contact 10g
	NC contact 4g
Test voltage	
coil/control contacts***	2'500Veff 1min
Test voltage	4'000Veff 1min
output contacts as against each other	
Test voltage contact open	1'500Veff 1min
Insulation resistance at Up 500V	10 <sup>8</sup> Ω
Creepage resistance	CTI 175
Weight	approx. 30g
Mounting position	any
Ambient temperature	-40°C to +70°C
Type of protection	RT III
Solder bath temperature	270°C/5s
Thermal resistance	45K/W
Temperature limit for coil	120°C
Pollution degree	2
Overvoltage category	III
Resistance to short circuiting	1'000A SCPD 6A gG (pre-fuse)

\*\* without spark suppression

\*\*\* SIS222 4000Veff 1min

### Insulation terms

Coil/control contacts: Basic insulation SIS312  
Double or reinforced insulation > 8mm SIS222  
Coil/control contacts to output contacts:  
Double or reinforced insulation > 8mm

### Tests, regulations

Approvals	SEV, UL, cUL, TÜV
UL File E188953	Sec. 5
Insulation class IEC 60664-1	250VAC
Protection class II	VDE 0106
Fire protection requirements	UL 94 / V0

## Diagrams

### Contact lifetime

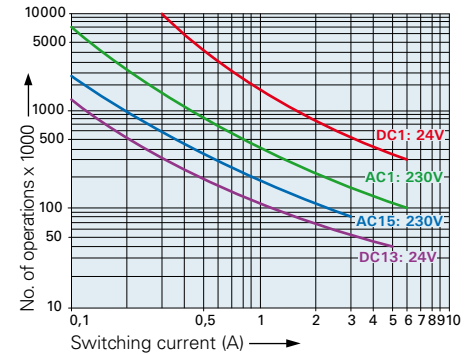

Max. switching characteristics (determined acc. to DIN EN 60947-4-1 / EN 60947-5-1):  
AC 1: 250V/6A AC 15: 230V/3A  
DC 1: 24V/6A DC 13: 24V/5A/0.1 Hz  
UL 508: B300 / R300

Maximal contact load at AC 1 with 230V:  
2 contacts each with 6A / 3 contacts each with 4A

### Load limit curve with direct current

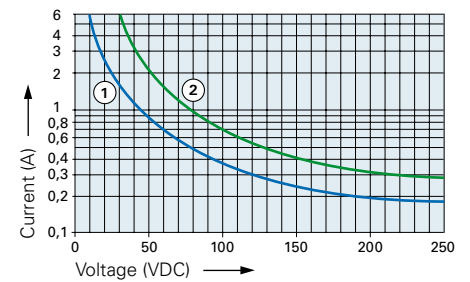

- 1) Inductive load, L/R 40 ms
- 2) Resistive load

### Excitation voltage range

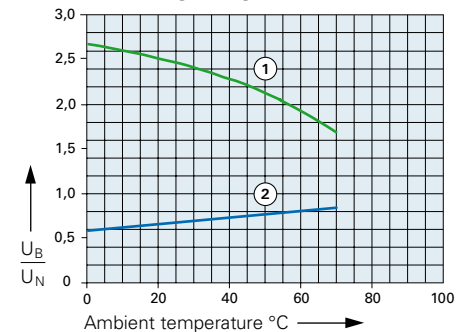

- 1) Max. excitation voltage with contact load ≤ 2A
- 2) Min. excitation voltage (guaranteed values) without previous operation

No heat accumulation due to intrinsic heating of other components.  
Continuous duty 100%.

### Ordering example

**SIS 3 1 2 24VDC**

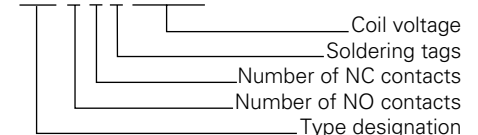



### Relay data

- PCB relay with forcibly guided contacts
- Protective separation between control and load circuit (leakage and creepage distance > 8mm)
- EN 50205, type A
- Double and reinforced insulation between the contacts
- Contact mounting: SIS422 4NO/2NC
- Small external dimensions
- Mean coil power 0.66W
- Holding power 0.20W
- For Railway Applications: EN 50155

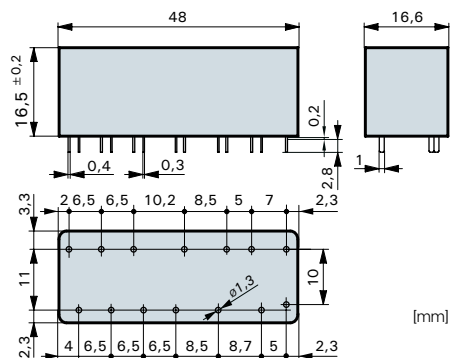

Contact material	AgCuNi+0.2-0.4µm Au
Type of contact	Single contact with notched crown
Rated switching capacity	250VAC 6A AC1 1'500VA
Electr. life AC1 (360 cycles/h)	approx. 100'000
Inrush current max.	30A for 20ms
Switching voltage range	5 to 250VDC/VAC
Switching current range*	5mA to 6A
Switching capacity range*	60mW to 1'500W (VA)
Contact resistance (as delivered)	≤ 100mΩ / 28 V / 100mA

\* Guide values

### Standard coils for direct current (other voltages on request)

Nominal voltage VDC	Min. pick-up voltage at 20°C	Drop-out voltage at 20 °C	Nominal current in mA	Resistance in Ohm at 20 °C	Tolerance in %
5	3,5	≥ 0,5	133	375	± 10
9	6,3	≥ 0,9	73,7	122	± 10
12	8,4	≥ 1,2	55,8	215	± 10
18	12,6	≥ 1,8	37,1	485	± 10
24	16,8	≥ 2,4	29,7	860	± 10
48	33,6	≥ 4,8	13,9	3'450	± 10
60	42,0	≥ 6,0	11,1	5'400	± 13
110	77,0	≥ 11,0	6,0	18'300	± 15

### Ordering example

SIS 4 2 2 24VDC

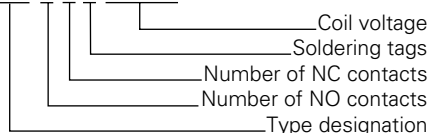

### General data

#### Circuit diagram (view on relay upper side)

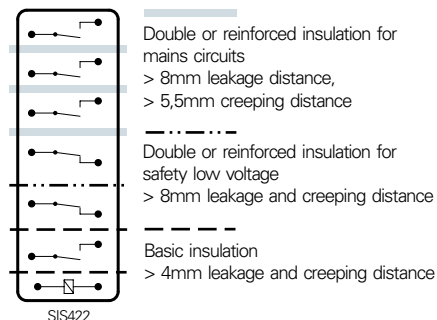

Mechanical life	> 10 x 10 <sup>6</sup> operations
Switching frequency, mechanical	15Hz
Response time (all NO closed)	typically 15ms
Drop-out time** (all NC closed)	typically 5ms
Bounce time of NO contact	typically 2ms
Bounce time of NC contact	typically 15ms
Shock resistance	16ms
	NO contact 10g
	NC contact 9g
Vibration resistant	NO contact 10g
	10-200Hz
	NC contact 3g
Test voltage	
coil/control contacts	2'500Veff 1min
Test voltage	4'000Veff 1min
output contacts as against each other	
Test voltage contact open	1'500Veff 1min
Insulation resistance at Up 500V	10 <sup>9</sup> Ω
Creepage resistance	CTI 175
Weight	approx. 35g
Mounting position	any
Ambient temperature	-40°C to +70°C
Type of protection	RT III
Solder bath temperature	270°C/5s
Thermal resistance	45K/W
Temperature limit for coil	120°C
Pollution degree	2
Overvoltage category	III
Resistance to short circuiting	1'000A SCPD 6A gG (pre-fuse)

\*\* without spark suppression

#### Insulation terms

Coil/control contacts: Basic insulation
Coil/control contacts to output contacts: Double or reinforced insulation > 8mm

#### Tests, regulations

Approvals	SEV, UL, cUL, TÜV
UL File E188953	Sec. 5
Insulation class IEC 60664-1	250VAC
Protection class II	VDE 0106
Fire protection requirements	UL 94 / V0

### Diagrams

#### Contact lifetime

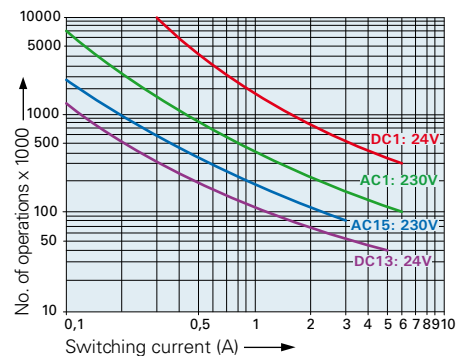

Max. switching characteristics (determined acc. to DIN EN 60947-4-1 / EN 60947-5-1):  
 AC 1: 250V/6A AC 15: 230V/3A  
 DC 1: 24V/6A DC 13: 24V/5A/0.1 Hz  
 UL 508: B300 / R300

Maximal contact load at AC 1 with 230V:  
 2 contacts each with 6A  
 3 contacts each with 4A  
 4 contacts each with 3A

#### Load limit curve with direct current

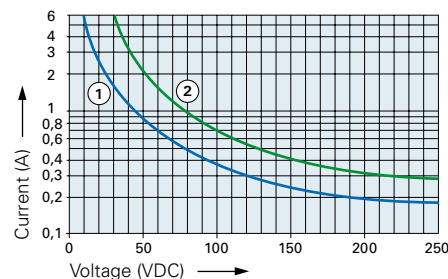

- 1) Inductive load, L/R 40 ms
- 2) Resistive load

#### Excitation voltage range

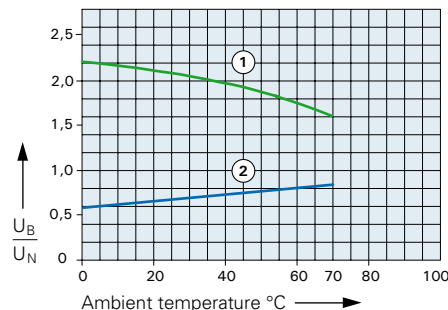

- 1) Max. excitation voltage with contact load ≤ 2A
- 2) Min. excitation voltage (guaranteed values) without previous operation

No heat accumulation due to intrinsic heating of other components.  
 Continuous duty 100%.



## Relay data

- PCB relay with forcibly guided contacts
- Protective separation between coil and contacts (> 5.5 mm) and contacts side by side (> 5.5 mm)
- EN 50205 type A
- Double and reinforced insulation
- SMD arrangement below relay possible
- Contact mounting: SIF312 3AK/1RK
- Compact height: only 10.9mm
- Mean coil power 0.70W
- Holding power 0.21 W
- For Railway Applications: EN 50155

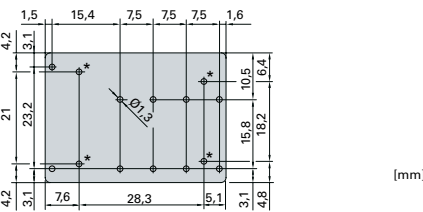
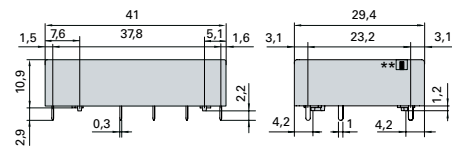

\* Do not drill when SMD arrangement.  
\*\* Open breathing hole

Contact material	AgCuNi + 0.2 µm Au
Type of contact	Single contact with notched crown
Rated switching capacity	250VAC 8A AC1 2'000VA
Electr. life AC1 (360 S/h)	approx. 100'000
Inrush current max	30A for 20ms
Switching voltage range	5 to 250VDC/VAC
Switching current range*	5mA to 8A
Switching capacity range*	60mW to 2'000W (VA)
Contact resistance (as delivered)	≤ 100mΩ/28V/100mA

## Standard coils for direct current (other voltages on request)

Nominal voltage VDC	Min. pick-up voltage at 20°C VDC	Drop-out voltage at 20°C VDC	Nominal current in mA	Resistance in Ohm at 20 °C	Tolerance in %
5	≤ 3.5	≥ 0.5	140.0	35.7	± 10
12	≤ 8.4	≥ 1.2	58.5	205	± 10
18	≤ 12.6	≥ 1.8	39.1	460	± 10
20	≤ 14.0	≥ 2.0	35.0	570	± 10
24	≤ 16.8	≥ 2.4	29.2	820	± 10
48	≤ 33.6	≥ 4.8	14.6	3'280	± 10
60	≤ 42.0	≥ 6.0	11.7	5'100	± 13
110	≤ 77.0	≥ 11.0	6.3	17'250	± 13

## Ordering example

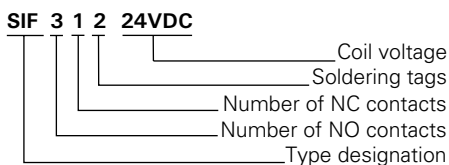

## General data

### Circuit diagram (view on relay upper side)

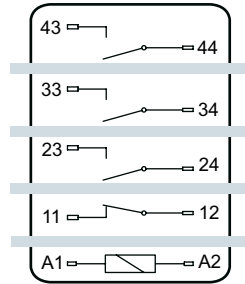

SIF-312

Double or reinforced insulation

Mechanical life	> 10 x 10 <sup>6</sup> operations
Switching frequency, mechanical	15Hz
Response time	typically 12ms
Drop-out time**	typically 5ms
Bounce time of NO contact	typically 1,5ms
Bounce time of NC contact	typically 15ms
Shock resistance 16ms	NO contact 15g NC contact 6g
Vibration resistance 10-200Hz	NO contact 10g NC contact 2g
Test voltage coil to contacts	4'000Veff 1min
Test voltage contacts against each other	4'000Veff 1min
Test voltage contact open	1'500Veff 1min
Insulation resistance at Up 500V	10 <sup>8</sup> Ω
Creepage resistance	CTI 175
Weight	approx. 20g
Mounting position	any
Ambient temperature	-40°C to +70°C
Type of protection	RT II
Solder bath temperature	270°C/5s
Thermal resistance	60K/W
Temperature limit for coil	120°C
Pollution degree	2
Overtoltage category	III
Resistance to short circuiting	1'000A SCPD 10A gL/gG (pre-fuse)

\*\* without spark suppression

### Insulation terms

Double or reinforced insulation >5.5mm between all current circuits

### Tests, regulations

Approvals	SEV, UL, cUL, TÜV
UL File E188953	Sec. 6
Insulation class IEC 60664-1	250VAC
Protection class II	VDE 0106
Fire protection requirements	UL 94 / V0

## Diagrams

### Contact lifetime

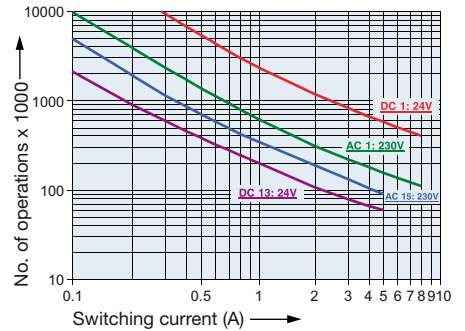

Max. switching characteristics (DIN EN 60947-4-1/ EN 60947-5-1):

- AC 1: 250V/8A
  - AC 15: 230V/5A
  - DC 1: 24V/8A
  - DC 13: 24V/5A/0.1Hz
  - UL508: B300/R300
- Maximal contact load at AC 1 with 230V:  
2 contacts each with 8A  
3 contacts each with 6A

### Load limit curve with direct current (Resistive load)

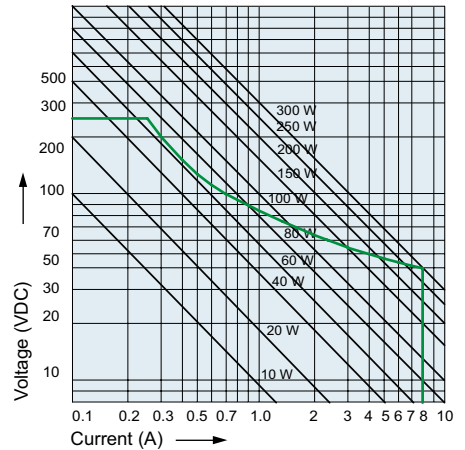

### Excitation voltage range

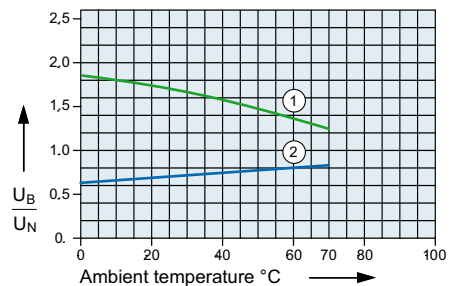

1) Max. excitation voltage with contact load ≤ 6A  
2) Min. excitation voltage (guaranteed values) without previous operation

No heat accumulation due to intrinsic heating of other components.  
Continuous duty 100%.



## Relay data

- PCB relay with forcibly guided contacts
- Protective separation between coil and contacts (> 5.5 mm) and contacts side by side (> 5.5 mm)
- EN 50205 type A
- Double and reinforced insulation
- SMD arrangement below relay possible
- Contact mounting: SIF422 4NO/2NC
- Compact height: only 10.9mm
- Mean coil power 0.66W
- Holding power 0.20 W
- For Railway Applications EN50155

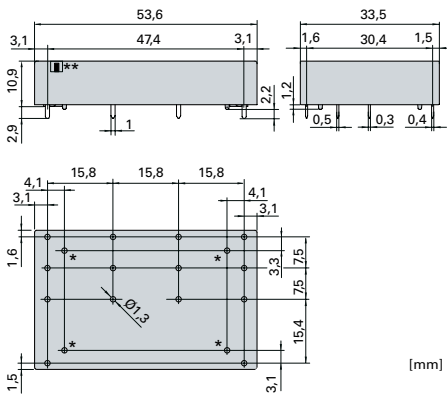

- \* Do not drill when SMD arrangement.
- \*\* Open breathing hole

Contact material	AgCuNi + 0.2 µm Au
Type of contact	Single contact with notched crown
Rated switching capacity	250VAC 8A AC1 2'000VA
Electr. life AC1 (360 S/h)	approx. 100'000
Inrush current max.	30A for 20ms
Switching voltage range	5 to 250VDC/VAC
Switching current range*	5mA to 8A
Switching capacity range*	60mW to 2'000W (VA)
Contact resistance (as delivered) ≤	100mΩ / 28 V / 100mA

\* Guide values

### Standard coils for direct current (other voltages on request)

Nominal voltage VDC	Min. pick-up voltage at 20°C VDC	Drop-out voltage at 20°C VDC	Nominal current in mA	Resistance in Ohm at 20 °C	Tolerance in %
5	≤ 3.5	≥ 0.5	133.3	375	± 10
12	≤ 8.4	≥ 1.2	55.8	215	± 10
18	≤ 12.6	≥ 1.8	38.9	462	± 10
20	≤ 14.0	≥ 2.0	33.3	600	± 10
24	≤ 16.8	≥ 2.4	27.5	870	± 10
48	≤ 33.6	≥ 4.8	13.8	3'460	± 10
60	≤ 42.0	≥ 6.0	11.1	5'400	± 13
110	≤ 77.0	≥ 11.0	6.0	18'300	± 15

### Ordering example

SIF 4 2 2 24VDC

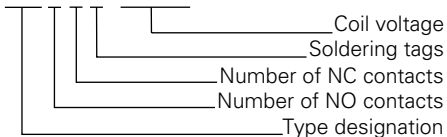

## General data

### Circuit diagram (view on relay upper side)

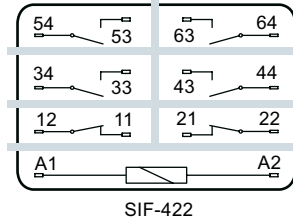

SIF-422

Double or reinforced insulation

Mechanical life	> 10 x 10 <sup>6</sup> operations
Switching frequency, mechanical	15Hz
Response time	typically 20ms
Drop-out time**	typically 8ms
Bounce time of NO contact	typically 1,5ms
Bounce time of NC contact	typically 15ms
Shock resistance 16ms	NO contact 10g NC contact 6g
Vibration resistance 10-200Hz	NO contact 10g NC contact 2g
Test voltage coil to contacts	4'000Veff 1min
Test voltage contacts against each other	4'000Veff 1min
Test voltage contact open	1'500Veff 1min
Insulation resistance at Up 500V	10 <sup>8</sup> Ω
Creepage resistance	CTI 175
Weight	approx. 35g
Mounting position	any
Ambient temperature	-40°C to +70°C
Type of protection	RT II
Solder bath temperature	270°C/5s
Thermal resistance	47K/W
Temperature limit for coil	120°C
Pollution degree	2
Overvoltage category	III
Resistance to short circuiting	1'000A SCPD 10A gL/gG (pre-fuse)

\*\* without spark suppression

### Insulation terms

Double or reinforced insulation >5.5mm between all current circuits

### Tests, regulations

Approvals	SEV, UL, cUL, TÜV
UL File E188953	Sec. 6
Insulation class IEC 60664-1	250VAC
Protection class II	VDE 0106
Fire protection requirements	UL 94 / V0

## Diagrams

### Contact lifetime

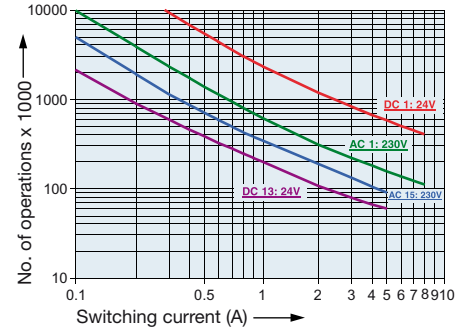

Max. switching characteristics (DIN EN 60947-4-1/ EN 60947-5-1):

- AC 1: 250V/8A
- AC 15: 230V/5A
- DC 1: 24V/8A
- DC 13: 24V/5A/0.1Hz
- UL508: B300/R300
- Maximal contact load at AC 1 with 230V:
  - 2 contacts each with 8A
  - 3 contacts each with 6A
  - 4 contacts each with 4.5A

### Load limit curve with direct current (Resistive load)

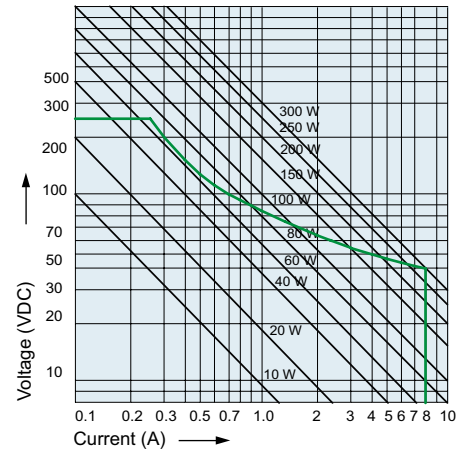

### Excitation voltage range

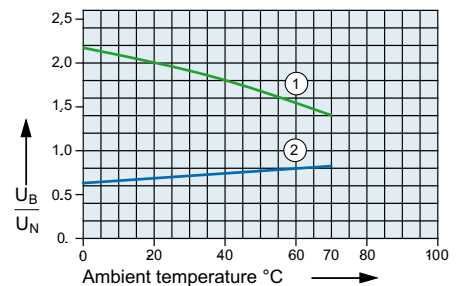

- 1) Max. excitation voltage with contact load ≤ 6A
- 2) Min. excitation voltage (guaranteed values) without previous operation

No heat accumulation due to intrinsic heating of other components.  
Continuous duty 100%..



## Relay data

- PCB relay with forcibly guided contacts
- Protective separation between coil and contacts (leakage and creepage distances > 14mm); protective separation diagonally between left and right contact side (leakage and creeping distances > 5.5mm)
- EN 50205, type B
- 2 CO contacts
- Mean coil power 1 W
- Holding power 0.31 W

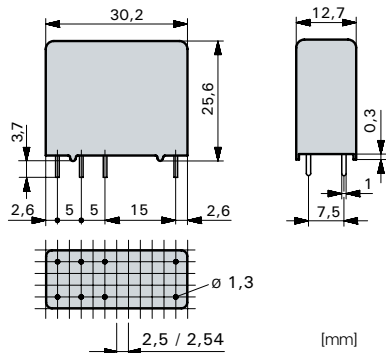

Contact material	AgCuNi
Type of contact	Single contact
Rated switching capacity	250VAC 6A AC1 1'500VA
Electr. life AC1 (360 cycles/h)	approx. 100'000
Inrush current max.	15A for 20ms
Switching voltage range	50 to 250 VDC/VAC
Switching current range*	20mA to 6A
Switching current range**	10mA to 6A
Switching capacity range*	0.12VA(W) to 1'500VA
Switching capacity range**	0.06VA(W) to 1'500VA
Contact resistance (as delivered)	≤ 100mΩ / 28V / 100mA

\* Guide values  
\*\* Values for AgCuNi + 4-6 μm Au

### Standard coils for direct current (other voltages on request)

Nominal voltage VDC	Min. pick-up voltage at 20°C	Drop-out voltage at 20°C	Nominal current in mA	Resistance in Ohm at 20°C	Tolerance in %
5	3,75	≥ 0,5	181,8	27,5	± 10
6	4,5	≥ 0,6	166,6	36	± 10
12	9,0	≥ 1,2	85,7	140	± 10
18	13,5	≥ 1,8	66,6	270	± 10
24	18,0	≥ 2,4	33,3	720	± 10
48	36,0	≥ 4,8	20,8	2'300	± 10
60	45,0	≥ 6,0	13,6	4'400	± 13
110	82,5	≥ 11,0	11,0	10'000	± 15

### Ordering example

**SGR282Z 24VDC AU6 08**

Type designation  
Coil voltage  
Gold plating 4 - 6μm Au  
Wash-resistant / with O-ring

## General data

### Circuit diagram (view on relay upper side)

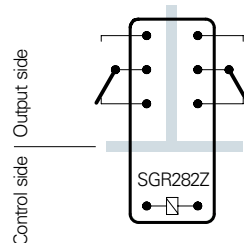

Mechanical life	> 50 x 10 <sup>6</sup> operations
Switching frequency, mechanical	20Hz
Response time	typically 12ms
Drop-out time***	typically 5ms
Bounce time of NO contact	typically 4ms
Bounce time of NC contact	typically 8ms
Vibration resistance	10-55Hz, AK 10g, RK 1.5g
Test voltage coil/contacts	5'000Veff 1min
Test voltage	
contact set/contact set	4'000Veff 1min
Test voltage contact open	1'500Veff 1min
Insulation resistance	10 <sup>11</sup> Ω
Creepage resistance	CTI 550
Weight	approx. 20g
Mounting position	any
Ambient temperature	-40°C to +70°C
Type of protection	RT II / RT III optionally
Solder bath temperature	270°C/5s
Thermal resistance	50K/W
Temperature limit for coil	120°C
Pollution degree	2
Resistance to short circuiting	1'000A SCPD 6A gL/gG (pre-fuse)

\*\*\* without spark suppression

### Insulation terms

Coil/contacts: Double or reinforced insulation > 14mm  
Left to right contact side:  
Double or reinforced insulation > 5.5mm

### Tests, regulations

Approvals	SEV, UL, cUL, TÜV
UL File E188953	Sec. 1
Insulation class IEC 60664-1	250VAC
Protection class II	VDE 0106
Fire protection requirements	UL 94 / V1

### Options, accessories

Contact material	SGR282Z..VDC AgCuNi +4 - 6μm Au
PCB socket, DIN rail socket	see page 29
Dust-resistant with O-Ring	
Sealed RT III	on request

## Diagrams

### Contact lifetime for AgCuNi

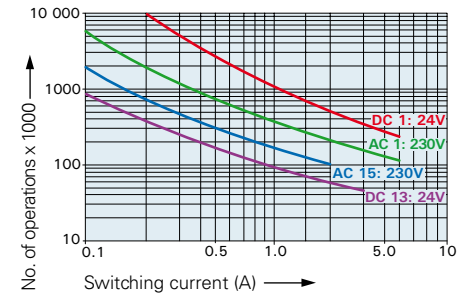

Max. switching characteristics (acc. to DIN EN 60947-5-1 table C2):  
AC 15: 230V/3A, DC13: 24V/4A  
UL 508: C300

Maximal contact load at AC 1 with 230V:  
2 contacts each with 6A

### Gold contacts with 4-6μm layer thickness

When high voltages and currents are switched, the layer of gold is destroyed already after a few switching operations. Once the gold layer is damaged due to the switching of high loads, such a contact must not be used any more for signal and control current circuits. Safe contact making is then only possible at high loads with the formation of sparks.

### Load limit curve with direct current

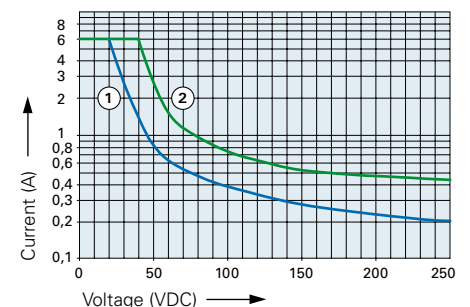

- 1) Inductive load, L/R 40 ms
- 2) Resistive load

### Excitation voltage range

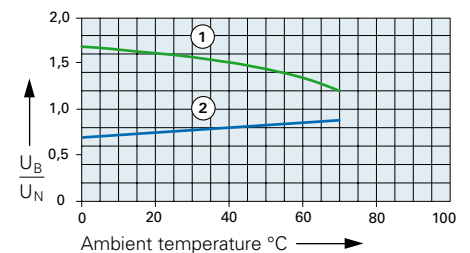

- 1) Max. excitation voltage with contact load ≤ 2A
- 2) Min. excitation voltage (guaranteed values) without previous operation

No heat accumulation due to intrinsic heating of other components.  
Continuous duty 100%.



## Relay data

- PCB relay with forcibly guided contacts
- Protective separation between coil and contacts (leakage and creepage distances > 14mm); protective separation diagonally between left and right contact side (leakage and creeping distances > 5.5mm)
- EN 50205, type B
- 2 CO contacts
- Mean coil power 0.7 W
- Holding power 0.21 W

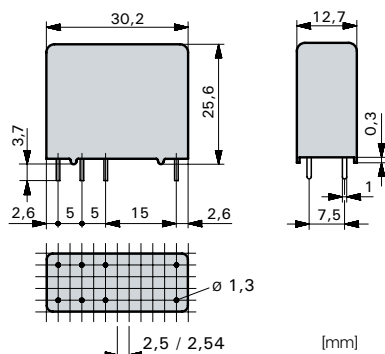

Contact material	AgCuNi
Type of contact	Single contact
Rated switching capacity	250VAC 6A AC1 1'500VA
Electr. life AC1 (360 cycles/h)	approx. 100'000
Inrush current max.	15A for 20ms
Switching voltage range	5 to 250 VDC/VAC
Switching current range*	20mA to 6A
Switching current range**	10mA to 6A
Switching capacity range*	0.12VA(W) to 1'500VA
Switching capacity range**	0.06VA(W) to 1'500VA
Contact resistance (as delivered)	<100mΩ/28 V/100mA

\* Guide values  
\*\* Values for AgCuNi + 4-6 μm Au

## Standard coils for direct current (other voltages on request)

Nominal voltage VDC	Min. pick-up voltage at 20°C	Drop-out voltage at 20°C	Nominal current in mA	Resistance in Ohm at 20°C	Tolerance in %
5	3,75	≥ 0,5	144,0	34,7	± 10
6	4,5	≥ 0,6	120,0	50	± 10
12	9,0	≥ 1,2	60,0	200	± 10
18	13,5	≥ 1,8	40,0	450	± 10
24	18,0	≥ 2,4	30,0	800	± 10
48	36,0	≥ 4,8	15,0	3'200	± 10
60	45,0	≥ 6,0	12,0	5'000	± 13
110	82,5	≥ 11,0	6,5	16'800	± 15

## Ordering example

**SGR282Z 24VDC SEN AU6 08**

Type designation  
Coil voltage  
sensitive coil  
Gold plating 4 - 6μm Au  
Wash-resistant / with O-ring

## General data

### Circuit diagram (view on relay upper side)

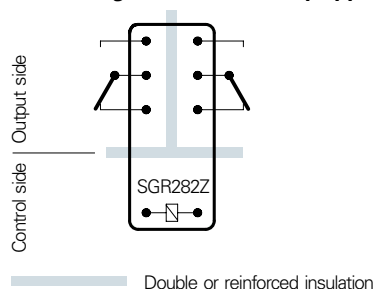

Mechanical life	> 50 x 10 <sup>6</sup> operations
Switching frequency, mechanical	20Hz
Response time	typically 12ms
Drop-out time***	typically 5ms
Bounce time of NO contact	typically 4ms
Bounce time of NC contact	typically 8ms
Vibration resistance	10-55Hz, AK 10g, RK 1.5g
Test voltage coil/contacts	5'000Veff 1min
Test voltage	
contact set/contact set	4'000Veff 1min
Test voltage contact open	1'500Veff 1min
Insulation resistance	10 <sup>11</sup> Ω
Creepage resistance	CTI 550
Weight	approx. 20g
Mounting position	any
Ambient temperature	-40°C to +70°C
Type of protection	RT II / RT III optionally
Solder bath temperature	270°C/5s
Thermal resistance	50K/W
Temperature limit for coil	120°C
Pollution degree	2
Resistance to short circuiting	1'000A SCPD 6A gL/gG (pre-fuse)

\*\*\* without spark suppression

### Insulation terms

Coil/contacts: Double or reinforced insulation > 14mm  
Left to right contact side:  
Double or reinforced insulation > 5.5mm

### Tests, regulations

Approvals	SEV, UL, cUL, TÜV
UL File E188953	Sec. 1
Insulation class IEC 60664-1	250VAC
Protection class II	VDE 0106
Fire protection requirements	UL 94 / V1

### Options, accessories

Contact material	SGR282Z..VDC S AgCuNi +4 - 6μm Au
PCB socket, DIN rail socket	see page 29
Dust-resistant with O-Ring	
Sealed RT III	on request

## Diagrams

### Contact lifetime for AgCuNi

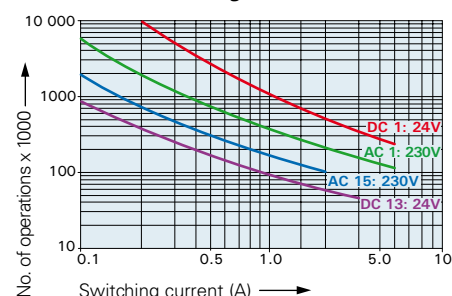

Max. switching characteristics (acc. to DIN EN 60947-5-1 table C2):  
AC 15: 230V/3A, DC13: 24V/4A  
UL508: C300

Maximal contact load at AC 1 with 230V:  
2 contacts each with 6A

### Gold contacts with 4-6μm layer thickness

When high voltages and currents are switched, the layer of gold is destroyed already after a few switching operations. Once the gold layer is damaged due to the switching of high loads, such a contact must not be used any more for signal and control current circuits. Safe contact making is then only possible at high loads with the formation of sparks.

### Load limit curve with direct current

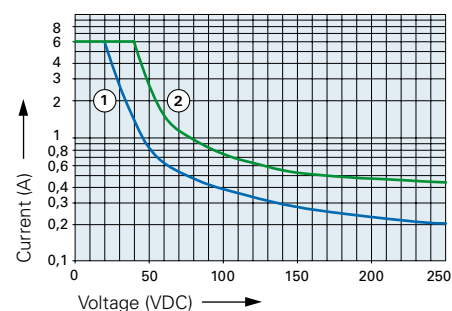

- 1) Inductive load, L/R 40 ms
- 2) Resistive load

### Excitation voltage range

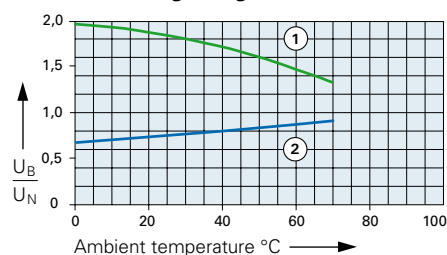

- 1) Max. excitation voltage with contact load ≤ 2A
- 2) Min. excitation voltage (guaranteed values) without previous operation

No heat accumulation due to intrinsic heating of other components.  
Continuous duty 100%.



## Relay data

- PCB relay with forcibly guided contacts
- Protective separation between coil and contacts (leakage and creepage distances > 14mm); protective separation diagonally between left and right contact side (leakage and creeping distances > 5.5mm)
- EN 50205, type B
- 2 CO contacts
- Mean coil power 1W
- Holding power 0.31 W

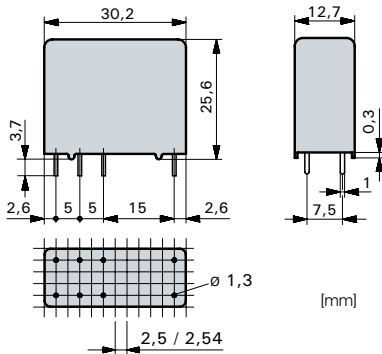

Contact material	AgSnO <sub>2</sub> +0.2μm Au
Type of contact	Single contact
Rated switching capacity	250VAC 8A AC1 2'000VA
Electr. life AC1 (360 cycles/h)	approx. 100'000
Inrush current max.	15A for 20ms
Switching voltage range	5 to 250 VDC/VAC
Switching current range*	10mA to 8A
Switching capacity range*	0.12VA(W) to 2'000VA
Contact resistance (as delivered)	≤100mΩ/28 V/100mA

\* Guide values

### Standard coils for direct current (other voltages on request)

Nominal voltage VDC	Min. pick-up voltage at 20°C	Drop-out voltage at 20°C	Nominal current in mA	Resistance in Ohm at 20°C	Tolerance in %
5	3,75	≥ 0,5	181,0	27,5	± 10
6	4,5	≥ 0,6	166,0	36	± 10
12	9,0	≥ 1,2	85,7	140	± 10
18	13,5	≥ 1,8	66,6	270	± 10
24	18,0	≥ 2,4	33,3	720	± 10
48	36,0	≥ 4,8	20,8	2'300	± 10
60	45,0	≥ 6,0	13,6	4'400	± 13
110	82,5	≥ 11,0	11,0	10'000	± 15

### Ordering example

**SIR282**      **24VDC 08**

Type designation      Coil voltage

Wash-resistant / with O-ring

## General data

### Circuit diagram (view on relay upper side)

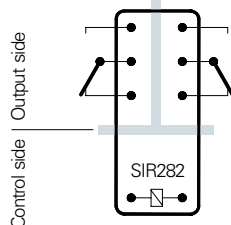

Control side      Output side

Double or reinforced insulation

Mechanical life	> 50 x 10 <sup>6</sup> operations
Switching frequency, mechanical	20Hz
Response time	typically 12ms
Drop-out time**	typically 5ms
Bounce time of NO contact	typically 4ms
Bounce time of NC contact	typically 8ms
Vibration resistance	10-55Hz, AK 10g, RK 1.5g
Test voltage coil/contacts	5'000Veff 1min
Test voltage contact set/contact set	4'000Veff 1min
Test voltage contact open	1'500Veff 1min
Insulation resistance	10 <sup>11</sup> Ω
Creepage resistance	CTI 550
Weight	approx. 20g
Mounting position	any
Ambient temperature	-40°C to +70°C
Type of protection	RT II / RT III optionally
Solder bath temperature	270°C/5s
Thermal resistance	50K/W
Temperature limit for coil	120°C
Pollution degree	2
Resistance to short circuiting	1'000A SCPD 10A gL/gG (pre-fuse)

\*\* without spark suppression

### Insulation terms

Coil/contacts: Double or reinforced insulation > 14mm  
Left to right contact side:  
Double or reinforced insulation > 5.5mm

### Tests, regulations

Approvals	SEV, UL, cUL, TÜV
UL File E188953	Sec. 1
Insulation class IEC 60664-1	250VAC
Protection class II	VDE 0106
Fire protection requirements	UL 94 / V1

### Options, accessories

Dust-resistant with O-Ring	
Sealed RT III	on request
PCB socket, DIN rail socket	see page 29

## Diagrams

### Contact lifetime for NO contact

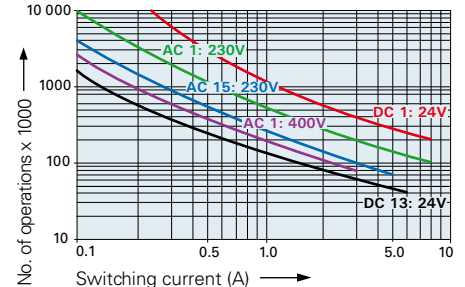

Max. switching characteristics (acc. to DIN EN 60947-5-1 table C2):  
AC 15: 230V/5A, DC13: 24V/6A; UL 508: C300  
Maximal contact load at AC 1 with 230V:  
2 contacts each with 8A

### Contact lifetime for NC contact

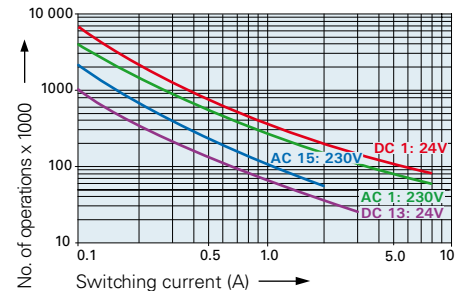

Max. switching characteristics (acc. to DIN EN 60947-5-1 table C2):  
AC 15: 230V/2A, DC13: 24V/3A

### Load limit curve with direct current

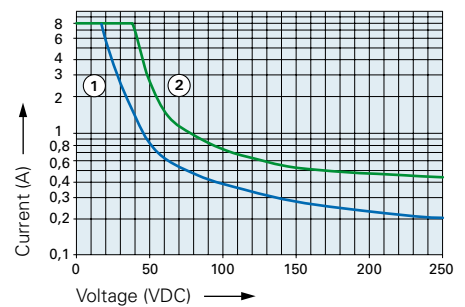

- 1) Inductive load, L/R 40 ms
- 2) Resistive load

### Excitation voltage range

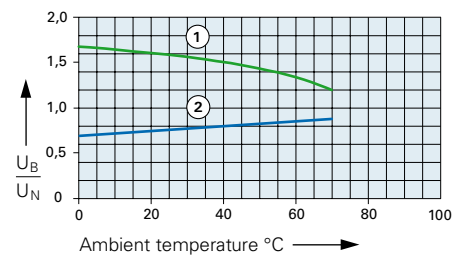

- 1) Max. excitation voltage with contact load ≤ 2A
- 2) Min. excitation voltage (guaranteed values) without previous operation

No heat accumulation due to intrinsic heating of other components. Continuous duty 100%.

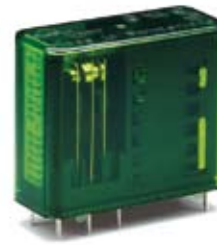

### Relay data

- PCB relay with forcibly guided contacts
- Protective separation between coil and contacts (leakage and creepage distances > 14mm); protective separation diagonally between left and right contact side (leakage and creeping distances > 5.5mm)
- EN 50205, type B
- 2 CO contacts
- Mean coil power 0.7W
- Holding power 0.21 W

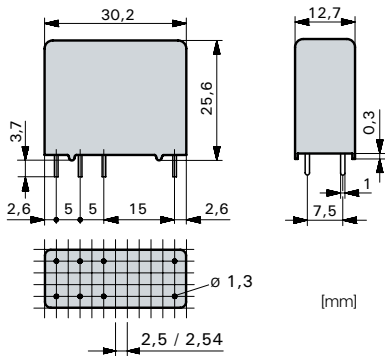

Contact material	AgSnO <sub>2</sub> +0.2μm Au
Type of contact	Single contact
Rated switching capacity	250VAC 8A AC1 2'000VA
Electr. life AC1 (360 cycles/h)	approx. 100'000
Inrush current max.	15A for 20ms
Switching voltage range	5 to 250 VDC/VAC
Switching current range*	10mA to 8A
Switching capacity range*	0.12VA(W) to 2'000VA
Contact resistance (as delivered)	≤100mΩ/28V/100mA

\* Guide values

### Standard coils for direct current (other voltages on request)

Nominal voltage VDC	Min. pick-up voltage at 20°C	Drop-out voltage at 20°C	Nominal current in mA	Resistance in Ohm at 20°C	Tolerance in %
5	3,75	≥ 0,5	144,0	34,7	± 10
6	4,5	≥ 0,6	120,0	50	± 10
12	9,0	≥ 1,2	60,0	200	± 10
18	13,5	≥ 1,8	40,0	450	± 10
24	18,0	≥ 2,4	30,0	800	± 10
48	36,0	≥ 4,8	15,0	3'200	± 10
60	45,0	≥ 6,0	12,0	5'000	± 13
110	82,5	≥ 11,0	6,5	16'800	± 15

### Ordering example

**SIR282 24VDC SEN 08**

Type designation  
Coil voltage  
sensitive coil  
Wash-resistant / with O-ring

### General data

#### Circuit diagram (view on relay upper side)

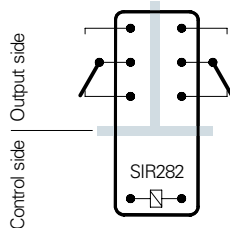

Mechanical life	> 50 x 10 <sup>6</sup> operations
Switching frequency, mechanical	20Hz
Response time	typically 12ms
Drop-out time**	typically 5ms
Bounce time of NO contact	typically 4ms
Bounce time of NC contact	typically 8ms
Vibration resistance	10-55Hz, AK 10g, RK 1.5g
Test voltage coil/contacts	5'000Veff 1min
Test voltage contact set/contact set	4'000Veff 1min
Test voltage contact open	1'500Veff 1min
Insulation resistance	10 <sup>11</sup> Ω
Creepage resistance	CTI 550
Weight	approx. 20g
Mounting position	any
Ambient temperature	-40°C to +70°C
Type of protection	RT II / RT III optionally
Solder bath temperature	270°C/5s
Thermal resistance	50K/W
Temperature limit for coil	120°C
Pollution degree	2
Resistance to short circuiting	1'000A SCPD 10A gL/gG (pre-fuse)

\*\* without spark suppression

#### Insulation terms

Coil/contacts: Double or reinforced insulation > 14mm  
Left to right contact side:  
Double or reinforced insulation > 5.5mm

#### Tests, regulations

Approvals	SEV, UL, cUL, TÜV
UL File E188953	Sec. 1
Insulation class IEC 60664-1	250VAC
Protection class II	VDE 0106
Fire protection requirements	UL 94 / V1

#### Options, accessories

Dust-resistant with O-Ring  
Sealed RT III on request  
PCB socket, DIN rail socket see page 29

### Diagrams

#### Contact lifetime for NO contact

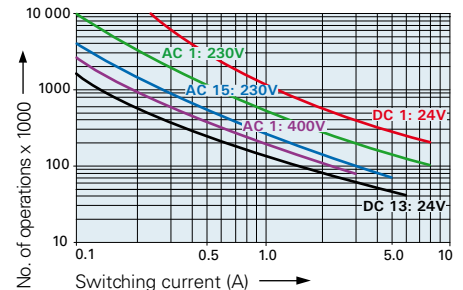

Max. switching characteristics (acc. to DIN EN 60947-5-1 table C2):  
AC 15: 230V/5A, DC13: 24V/6A; UL 508: C300  
Maximal contact load at AC 1 with 230V:  
2 contacts each with 8A

#### Contact lifetime for NC contact

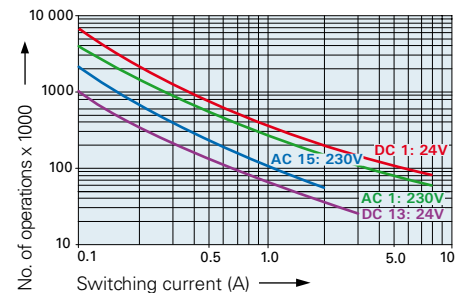

Max. switching characteristics (acc. to DIN EN 60947-5-1 table C2):  
AC 15: 230V/2A, DC13: 24V/3A

#### Load limit curve with direct current

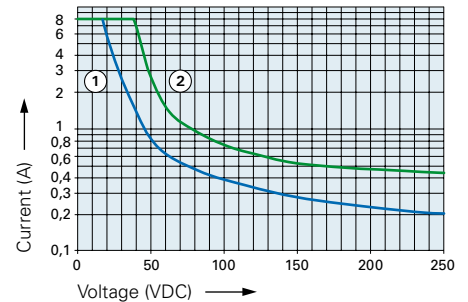

- 1) Inductive load, L/R 40 ms
- 2) Resistive load

#### Excitation voltage range

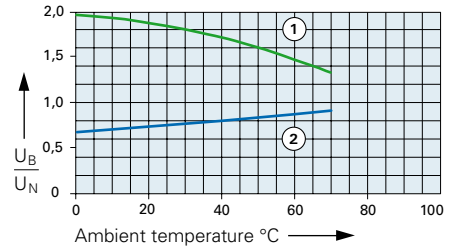

- 1) Max. excitation voltage with contact load ≤ 2A
- 2) Min. excitation voltage (guaranteed values) without previous operation

No heat accumulation due to intrinsic heating of other components. Continuous duty 100%.





## Relay data

- PCB relay with forcibly guided contacts
- Protective separation between coil and contacts (leakage and creepage distances > 14mm); protective separation between left and right contact side (leakage and creeping distances > 5.5mm)
- EN 50205, type A
- Contact mounting: SIM112 1NO/1NC
- Small external dimensions
- Mean coil power 0.5W
- Holding power 0.15 W

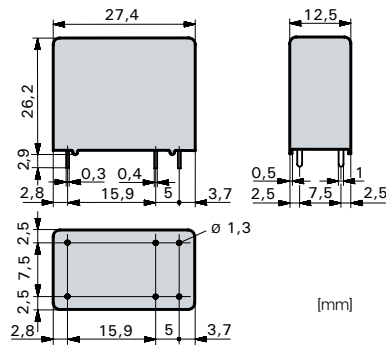

Contact material	AgSnO <sub>2</sub> +0.2μm Au
Type of contact	Crest contact
Rated switching capacity	250VAC 8A AC1 2'000VA
Electr. life AC1 (360 cycles/h)	approx. 100'000
Inrush current max.	20A for 20ms
Switching voltage range	5 to 250 VDC/VAC
Switching current range*	10mA to 8A
Switching capacity range*	0.06VA(V) to 2'000VA
Contact resistance (as delivered)	≤100mΩ/28V/100mA

\* Guide values

## Standard coils for direct current (other voltages on request)

Nominal voltage VDC	Min. pick-up voltage at 20°C	Drop-out voltage at 20 °C	Nominal current in mA	Resistance in Ohm at 20 °C	Tolerance in %
5	3,5	≥ 0,5	111,0	45	± 10
6	4,2	≥ 0,6	85,7	70	± 10
12	8,4	≥ 1,2	44,4	270	± 10
21	14,7	≥ 2,1	23,8	880	± 10
24	16,8	≥ 2,4	21,8	1'100	± 10
48	33,6	≥ 4,8	10,9	4'400	± 13
60	42,0	≥ 6,0	8,7	6'850	± 15
110	77,0	≥ 11,0	5,5	20'000	± 15

## Ordering example

**SIM 1 1 2 24VDC**

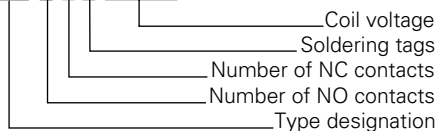

## General data

### Circuit diagram (view on relay upper side)

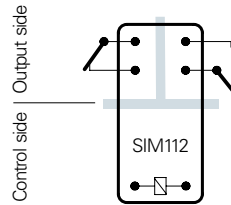

Double or reinforced insulation

Mechanical life	> 10 x 10 <sup>6</sup> operations
Switching frequency, mechanical	15Hz
Response time	typically 10ms
Drop-out time**	typically 3ms
Bounce time of NO contact	typically 6ms
Bounce time of NC contact	typically 12ms
Shock resistance 16ms	NO contact > 10g NC contact 2,5g
Vibration resistance 10-200Hz	NO contact > 10g NC contact 1g
Test voltage coil/contacts	5'000Veff 1min
Test voltage left to right contact sides	4'000Veff 1min
Test voltage contact open	1'500Veff 1min
Insulation resistance	10 <sup>11</sup> Ω
Creepage resistance	CTI 250
Weight	approx. 20g
Mounting position	any
Ambient temperature	-40°C to +70°C
Type of protection	RT II
Solder bath temperature	270 °C/5s
Thermal resistance	55K/W
Temperature limit for coil	120°C
Pollution degree	2
Overvoltage category	III
Resistance to short circuiting	1'000A SCPD 10A gG (pre-fuse)

\*\* without spark suppression

### Insulation terms

Coil/contacts:	Double or reinforced insulation > 14mm
Left to right contact side:	Double or reinforced insulation > 5.5mm

### Tests, regulations

Approvals	SEV, UL, cUL, TÜV
UL File E188953	Sec. 3
Insulation class IEC 60664-1	250VAC
Protection class II	VDE 0106
Fire protection requirements	UL 94 / V0

## Diagrams

### Contact lifetime for NO contact

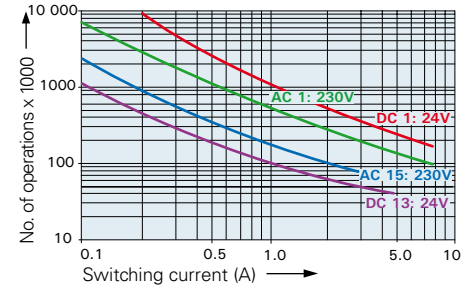

Max. switching characteristics (determined acc. to DIN EN 60947-5-1 table C2):  
 AC 15: 230V/3A  
 DC 13: 24V/4A  
 DC 13: 24V/6A/0,1Hz  
 UL 508: C150/R300

### Load limit curve with direct current

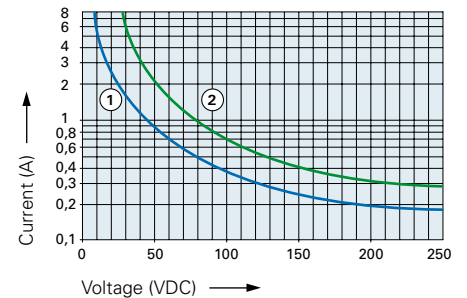

- 1) Inductive load, L/R 40 ms
- 2) Resistive load

### Excitation voltage range

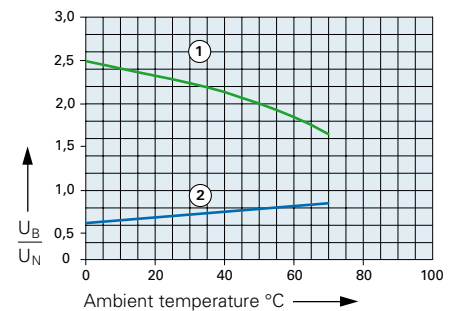

- 1) Max. excitation voltage with contact load ≤ 2A
  - 2) Min. excitation voltage (guaranteed values) without previous operation
- No heat accumulation due to intrinsic heating of other components.  
 Continuous duty 100%.



### Relay data

- PCB relay with forcibly guided contacts
- Protective separation between coil and contacts (leakage and creepage distances > 14mm); protective separation between left and right contact side (leakage and creeping distances > 5.5mm)
- EN 50205, type A
- Contact mounting: SIM212 2NO/1NC
- Small external dimensions
- Mean coil power 0.75W
- Holding power 0.21 W

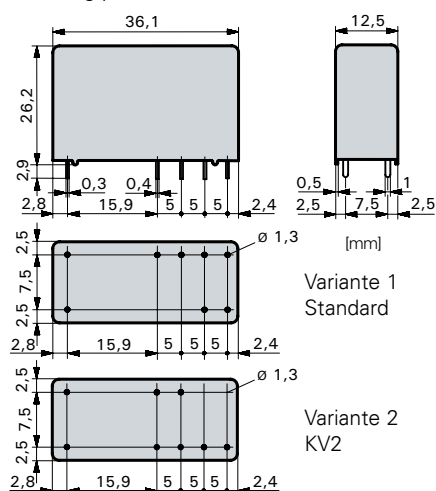

Contact material	AgSnO <sub>2</sub> +0.2μm Au
Type of contact	Crest contact
Rated switching capacity	250VAC 8A AC1 2'000VA
Electr. life AC1 (360 cycles/h)	approx. 100'000
Inrush current max.	20A for 20ms
Switching voltage range	5 to 250 VDC/VAC
Switching current range*	10mA to 8A
Switching capacity range*	0.06VA(W) to 2'000VA
Contact resistance (as delivered)	<100mΩ/28 V/100mA

\* Guide values

### Standard coils for direct current (other voltages on request)

Nominal voltage VDC	Min. pick-up voltage at 20°C	Drop-out voltage at 20 °C	Nominal current in mA	Resistance in Ohm at 20 °C	Tolerance in %
5	3,75	≥ 0,5	151,0	33	± 10
6	4,5	≥ 0,6	125,0	48	± 10
12	9,0	≥ 1,2	63,1	190	± 10
21	15,75	≥ 2,1	35,5	590	± 10
24	18,0	≥ 2,4	30,0	800	± 10
48	36,0	≥ 4,8	15,4	3'100	± 10
60	45,0	≥ 6,0	12,5	4'800	± 13
110	82,5	≥ 11,0	6,8	16'000	± 15

### Ordering example

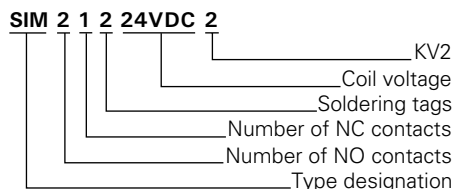

### General data

#### Circuit diagram (view on relay upper side)

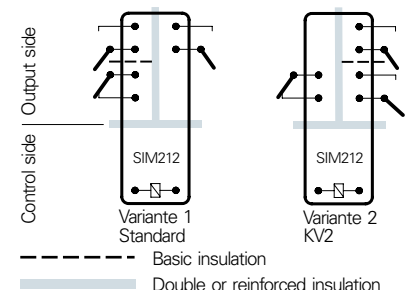

Mechanical life	> 10 x 10 <sup>6</sup> operations
Switching frequency, mechanical	15Hz
Response time	typically 10ms
Drop-out time**	typically 4ms
Bounce time of NO contact	typically 6ms
Bounce time of NC contact	typically 12ms
Shock resistance	16ms NO contact > 10g NC contact 2,5g
Vibration resistance	10-200Hz NO contact > 10g NC contact 1g
Test voltage coil/contacts	5'000Veff 1min
Test voltage left to right contact sides	4'000Veff 1min
Test voltage contacts as one after the other	2'500Veff 1min
Test voltage contact open	1'500Veff 1min
Insulation resistance	10 <sup>11</sup> Ω
Creepage resistance	CTI 250
Weight	approx. 25g
Mounting position	any
Ambient temperature	-40°C to +70°C
Type of protection	RT II
Solder bath temperature	270 °C/5s
Thermal resistance	50K/W
Temperature limit for coil	120°C
Pollution degree	2
Overvoltage category	III
Resistance to short	1'000A SCPD 10A circuiting

\*\* without spark suppression

#### Insulation terms

Coil/contacts: Double or reinforced insulation > 14mm  
Left to right contact side: Double or reinforced insulation > 5.5mm  
Contacts in one row: Basic insulation

#### Tests, regulations

Approvals	SEV, UL, cUL, TÜV
UL File E188953	Sec. 3
Insulation class IEC 60664-1	250VAC
Protection class II	VDE 0106
Fire protection requirements	UL 94 / V0

#### Options, accessories

PCB socket, DIN rail socket see page 30

### Diagrams

#### Contact lifetime for NO contact

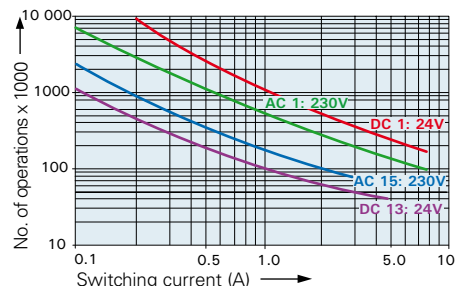

Max. switching characteristics (determined acc. to DIN EN 60947-5-1 table C2):  
AC 15: 230V/3A  
DC 13: 24V/4A  
DC 13: 24V/6A/0,1Hz  
UL 508: C150/R300

Maximal contact load at AC 1 with 230V:  
2 contacts each with 8A

#### Load limit curve with direct current

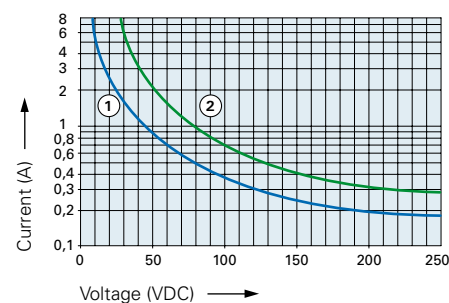

- 1) Inductive load, L/R 40 ms
- 2) Resistive load

#### Excitation voltage range

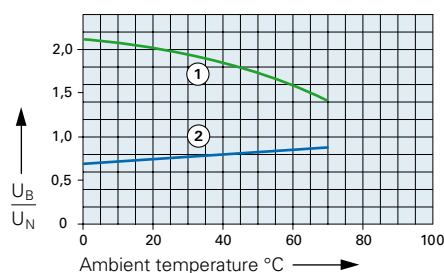

- 1) Max. excitation voltage with contact load ≤ 2A
- 2) Min. excitation voltage (guaranteed values) without previous operation

No heat accumulation due to intrinsic heating of other components.  
Continuous duty 100%.



## Relay data

- PCB relay with forcibly guided contacts
- Protective separation between coil and contacts (leakage and creepage distances > 14mm); protective separation between left and right contact side (leakage and creeping distances > 5.5mm)
- EN 50205, type A
- Contact mounting:  
SIM312 3NO/1NC  
SIM222 2NO/2NC
- Small external dimensions
- Mean coil power 1W
- Holding power 0.29W

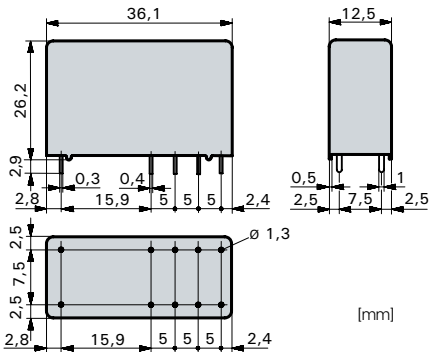

Contact material	AgSnO <sub>2</sub> +0,2µm Au
Type of contact	Crest contact
Rated switching capacity	250VAC 8A AC1 2'000VA
Electr. life AC1 (360 cycles/h)	approx. 100'000
Inrush current max.	20A for 20ms
Switching voltage range	5 to 250 VDC/VAC
Switching current range*	10mA to 8A
Switching capacity range*	0,06VA(V) to 2'000VA
Contact resistance (as delivered)	<100mΩ/28 V/100mA

\* Guide values

## Standard coils for direct current (other voltages on request)

Nominal voltage VDC	Min. pick-up voltage at 20°C	Drop-out voltage at 20 °C	Nominal current in mA	Resistance in Ohm at 20 °C	Tolerance in %
5	3,75	≥ 0,5	181,8	275	± 10
6	4,5	≥ 0,6	166,0	36	± 10
12	9,0	≥ 1,2	85,7	140	± 10
21	15,75	≥ 2,1	46,6	450	± 10
24	18,0	≥ 2,4	40,0	600	± 10
48	36,0	≥ 4,8	20,8	2'300	± 10
60	45,0	≥ 6,0	16,6	3'600	± 13
110	82,5	≥ 11,0	9,6	12'000	± 15

## Ordering example

**SIM 3 1 2 24VDC**

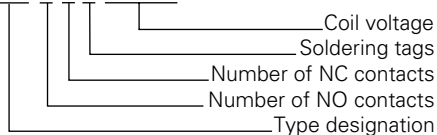

## General data

### Circuit diagram (view on relay upper side)

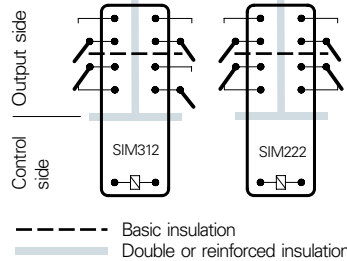

Mechanical life	> 10 x 10 <sup>6</sup> operations
Switching frequency, mechanical	15Hz
Response time	typically 8ms
Drop-out time**	typically 4ms
Bounce time of NO contact	typically 6ms
Bounce time of NC contact	typically 12ms
Shock resistance	16ms NO contact > 10g NC contact 2,5g
Vibration resistance	NO contact > 10g 10-200Hz NC contact 1g
Test voltage coil/contacts	5'000Veff 1min
Test voltage left to right contact sides	4'000Veff 1min
Test voltage contacts as one after the other	2'500Veff 1min
Test voltage contact open	1'500Veff 1min
Insulation resistance	10 <sup>11</sup> Ω
Creepage resistance	CTI 250
Weight	approx. 25g
Mounting position	any
Ambient temperature	-40°C to +70°C
Type of protection	RT II
Solder bath temperature	270 °C/5s
Thermal resistance	50K/W
Temperature limit for coil	120°C
Pollution degree	2
Overvoltage category	III
Resistance to short circuiting	1'000A SCPD 10A gG (pre-fuse)

\*\* without spark suppression

### Insulation terms

Coil/contacts:  
Double or reinforced insulation > 14mm  
Left to right contact side:  
Double or reinforced insulation > 5.5mm  
Contacts in one row: Basic insulation

### Tests, regulations

Approvals	SEV, UL, cUL, TÜV
UL File E18895	Sec. 3
Insulation class IEC 60664-1	250VAC
Protection class II	VDE 0106
Fire protection requirements	UL 94 / V0

### Options, accessories

PCB socket, DIN rail socket see page 30

## Diagrams

### Contact lifetime for NO contact

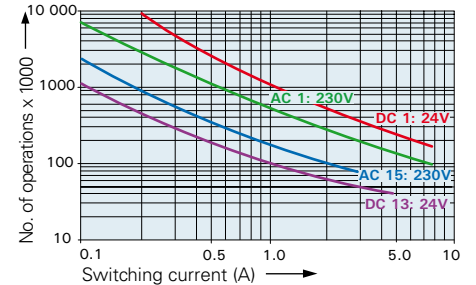

Max. switching characteristics (determined acc. to DIN EN 60947-5-1 table C2):  
AC 15: 230V/3A  
DC 13: 24V/4A  
DC 13: 24V/6A/0,1Hz  
UL 508: C150/R300

Maximal contact load at AC 1 with 230V:  
2 contacts each with 8A  
3 contacts each with 6A

### Load limit curve with direct current

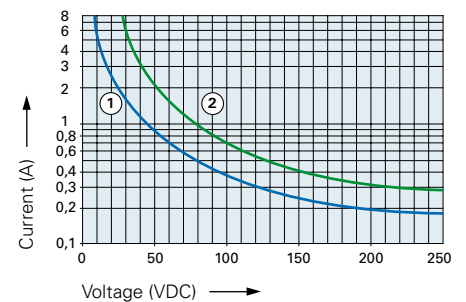

- 1) Inductive load, L/R 40 ms
- 2) Resistive load

### Excitation voltage range

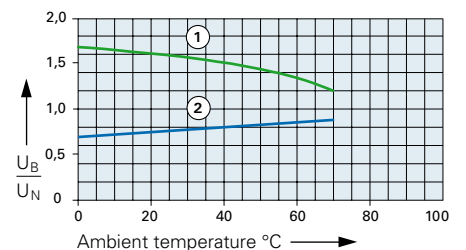

- 1) Max. excitation voltage with contact load ≤ 2A
- 2) Min. excitation voltage (guaranteed values) without previous operation

No heat accumulation due to intrinsic heating of other components.  
Continuous duty 100%.



## Relay data

- PCB relay with forcibly guided contacts
- Protective separation between coil/control contacts and output contacts (> 8mm) as well as protective separation between the output contacts themselves (> 10mm)
- EN 50205, type A
- Contact mounting:  
SLR312 3NO/1NC  
SLR222 2NO/2NC
- Small external dimensions
- Mean coil power 0.6W
- Holding power 0.18W
- For Railway Applications: EN 50155

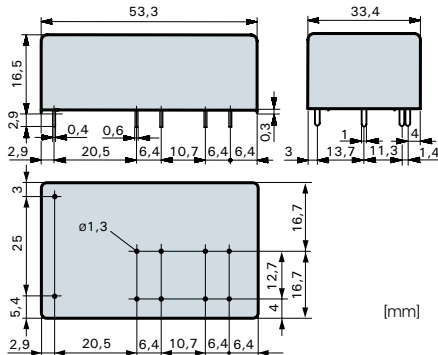

Contact material	AgSnO <sub>2</sub> +0,2µm Au
Type of contact	Crest contact
Rated switching capacity	250VAC 10A AC1 2'500VA
Electr. life AC1 (360 cycles/h)	approx. 100'000
Inrush current max.	25A for 20ms
Switching voltage range	5 to 250 VDC/VAC
Switching current range*	10mA to 10A
Switching capacity range*	0.06VA(W) to 2'500VA
Contact resistance (as delivered)	≤100mΩ/28V/100mA

\* Guide values

### Standard coils for direct current (other voltages on request)

Nominal voltage VDC	Min. pick-up voltage at 20°C	Drop-out voltage at 20 °C	Nominal current in mA	Resistance in Ohm at 20 °C	Tolerance in %
5	3,5	≥ 0,5	121,0	41	± 10
6	4,2	≥ 0,6	100,0	60	± 10
12	8,4	≥ 1,2	50,0	240	± 10
18	12,6	≥ 1,8	33,3	540	± 10
24	16,8	≥ 2,4	25,2	950	± 10
48	33,6	≥ 4,8	12,6	3'800	± 10
60	42,0	≥ 6,0	10,0	6'000	± 13
110	77,0	≥ 11,0	5,5	20'000	± 15

### Ordering example

**SLR 3 1 2 24VDC**

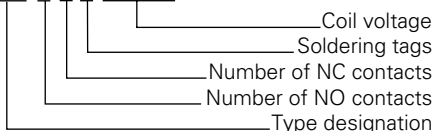

## General data

### Circuit diagram (view on relay upper side)

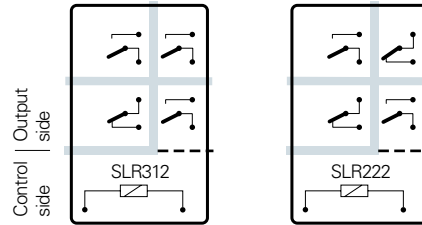

- - - - Basic insulation
- ▬ Double or reinforced insulation

Mechanical life	> 10 x 10 <sup>6</sup> operations
Switching frequency, mechanical	15Hz
Response time	typically 15ms
Drop-out time**	typically 4ms
Bounce time of NO contact	typically 6ms
Bounce time of NC contact	typically 12ms
Shock resistance	16ms NO contact > 10g NC contact 6g
Vibration resistance	NO contact > 5g 10-200Hz NC contact 1.5g
Test voltage	
coil/control contacts	2'500Veff 1min
Test voltage	5'000Veff 1min
coil-control contacts/output contacts	
Test voltage output contacts	
as against each other	4'000Veff 1min
Test voltage contact open	1'500Veff 1min
Insulation resistance	10 <sup>11</sup> Ω
Creepage resistance	CTI 250
Weight	approx. 30g
Mounting position	any
Ambient temperature	-40°C to +70°C
Type of protection	RT II
Solder bath temperature	270 °C/5s
Thermal resistance	55K/W
Temperature limit for coil	120°C
Pollution degree	2
Overvoltage category	III
Resistance to short circuiting	1'000A SCPD 10A gG (pre-fuse)

\*\* without spark suppression

### Insulation terms

Coil/control contacts NO:	Basic insulation
Coil/control contacts to output contacts:	Double or reinforced insulation > 8mm
Output contacts as against each other:	Reinforced insulation > 10mm

### Tests, regulations

Approvals	SEV, UL, cUL, TÜV
UL File E188953	Sec. 3
Insulation class IEC 60664-1	250VAC
Protection class II	VDE 0106
Fire protection requirements	UL 94 / V0

## Diagrams

### Contact lifetime

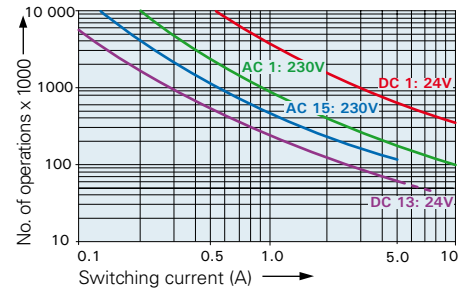

Max. switching characteristics (determined acc. to DIN EN 60947-5-1 table C2):  
AC 15: 230V/5A  
DC 13: 24V/7.5A/0.1 Hz  
UL 508: C600/R300

Maximal contact load at AC 1 with 230V:  
2 contacts each with 10A  
3 contacts each with 8.4A

### Load limit curve with direct current

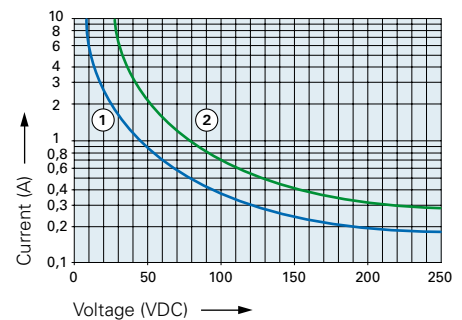

- 1) Inductive load, L/R 40 ms
- 2) Resistive load

### Excitation voltage range

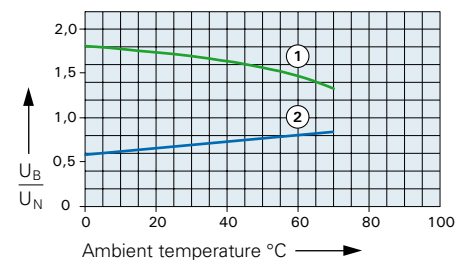

- 1) Max. excitation voltage with contact load ≤ 2A
- 2) Min. excitation voltage (guaranteed values) without previous operation

No heat accumulation due to intrinsic heating of other components.  
Continuous duty 100%.



## Relay data

- PCB relay with forcibly guided contacts
- Protective separation between coil/control contacts and output contacts (> 10mm) as well as protective separation between the output contacts themselves (> 8mm)
- EN 50205, type A
- Contact mounting:  
SIR312 3NO/1NC  
SIR222 2NO/2NC
- Small external dimensions
- Mean coil power 0.6W
- Holding power 0.18W
- For Railway Applications: EN 50155

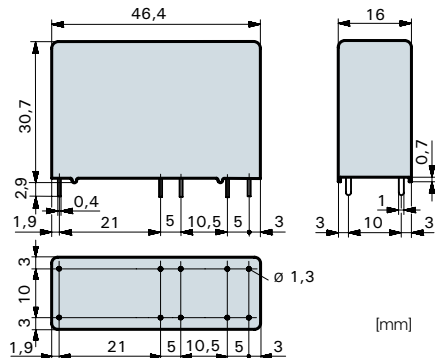

Contact material	AgSnO <sub>2</sub> +0.2µm Au
Type of contact	Crest contact
Rated switching capacity	250VAC 10A AC1 2'500VA
Electr. life AC1 (360 cycles/h)	approx. 100'000
Inrush current max.	25A for 20ms
Switching voltage range	5 to 250 VDC/VAC
Switching current range*	10mA to 10A
Switching capacity range*	0.06VA(W) to 2'500VA
Contact resistance (as delivered)	≤100mΩ/28 V/100mA

\* Guide values

## Standard coils for direct current (other voltages on request)

Nominal voltage VDC	Min. pick-up voltage at 20°C	Drop-out voltage at 20 °C	Nominal current in mA	Resistance in Ohm at 20 °C	Tolerance in %
5	3,5	≥ 0,5	121,0	41	± 10
6	4,2	≥ 0,6	100,0	60	± 10
12	8,4	≥ 1,2	50,0	240	± 10
18	12,6	≥ 1,8	33,3	540	± 10
24	16,8	≥ 2,4	25,2	950	± 10
48	33,6	≥ 4,8	12,6	3'800	± 10
60	42,0	≥ 6,0	10,0	6'000	± 13
110	77,0	≥ 11,0	5,5	20'000	± 15

## Ordering example

**SIR 3 1 2 24VDC**

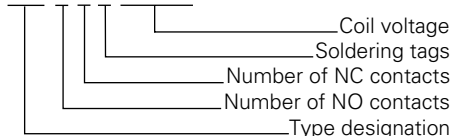

## General data

### Circuit diagram (view on relay upper side)

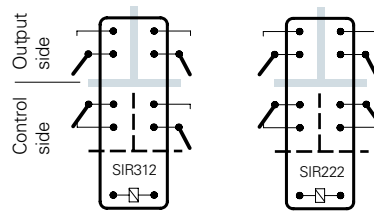

--- Basic insulation  
 Double or reinforced insulation

Mechanical life	> 10 x 10 <sup>6</sup> operations
Switching frequency, mechanical	15Hz
Response time	typically 15ms
Drop-out time**	typically 4ms
Bounce time of NO contact	typically 6ms
Bounce time of NC contact	typically 12ms
Shock resistance	16ms NO contact > 10g NC contact 6g
Vibration resistance	10-200Hz NO contact > 5g NC contact 1,5g
Test voltage	
coil/control contacts	2'500Veff 1min
Test voltage	5'000Veff 1min
coil-control contacts/output contacts	
Test voltage output contacts	
as against each other	4'000Veff 1min
Test voltage contact open	1'500Veff 1min
Insulation resistance	10 <sup>11</sup> Ω
Creepage resistance	CTI 250
Weight	approx. 30g
Mounting position	any
Ambient temperature	-40°C to +70°C
Type of protection	RT II
Solder bath temperature	270 °C/5s
Thermal resistance	55K/W
Temperature limit for coil	120°C
Pollution degree	2
Overtoltage category	III
Resistance to short circuiting	1'000A SCPD 10A gG (pre-fuse)

\*\* without spark suppression

### Insulation terms

Coil to control contacts:	Basic insulation
Coil/control contacts to output contacts:	Double or reinforced insulation > 10mm
Output contacts as against each other:	Double or reinforced insulation > 8mm

### Tests, regulations

Approvals	SEV, UL, cUL, TÜV
UL File E188953	Sec. 3
Insulation class IEC 60664-1	250VAC
Protection class II	VDE 0106
Fire protection requirements	UL 94 / V0

### Options, accessories

PCB socket	see page 31
------------	-------------

## Diagrams

### Contact lifetime

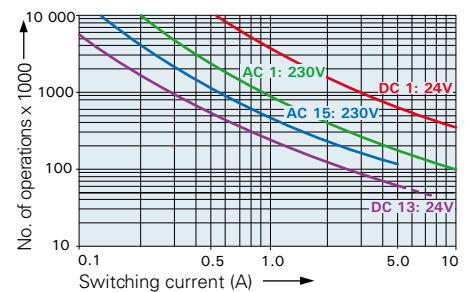

Max. switching characteristics (determined acc. to DIN EN 60947-5-1 table C2):  
 AC 15: 230V/5A  
 DC 13: 24V/7.5A/0.1 Hz  
 UL 508: C600/R300

Maximal contact load at AC 1 with 230V:  
 2 contacts each with 10A  
 3 contacts each with 8.4A

### Load limit curve with direct current

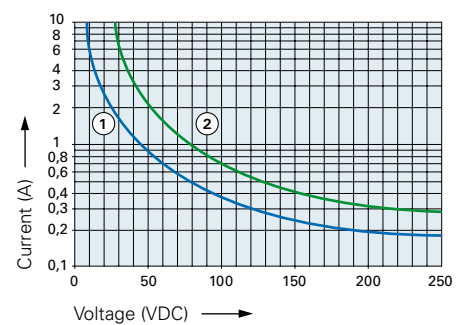

- 1) Inductive load, L/R 40 ms
- 2) Resistive load

### Excitation voltage range

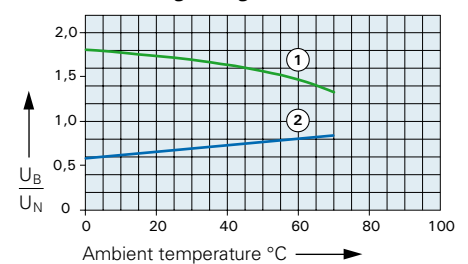

- 1) Max. excitation voltage with contact load ≤ 2A
- 2) Min. excitation voltage (guaranteed values) without previous operation

No heat accumulation due to intrinsic heating of other components.  
 Continuous duty 100%.



## Relay data

- PCB relay with forcibly guided contacts
- Protective separation between coil/control contacts and output contacts (> 10mm) as well as protective separation between the output contacts themselves (> 8mm)
- EN 50205, type A
- Contact mounting:  
SIR312 3NO/1NC  
SIR222 2NO/2NC
- Small external dimensions
- Mean coil power 0.36W
- Holding power 0.12W
- For Railway Applications: EN 50155

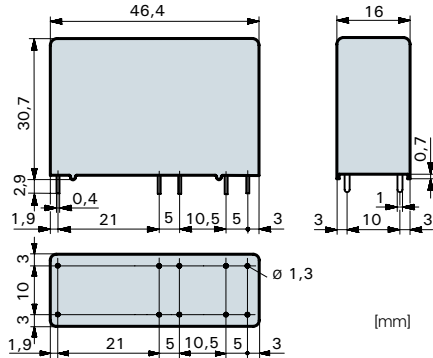

Contact material	AgSnO <sub>2</sub> +0.2µm Au
Type of contact	Crest contact
Rated switching capacity	250VAC 10A AC1 2'500VA
Electr. life AC1 (360 cycles/h)	approx. 100'000
Inrush current max.	25A for 20ms
Switching voltage range	5 to 250 VDC/VAC
Switching current range*	10mA to 10A
Switching capacity range*	0.06VA(W) to 2'500VA
Contact resistance (as delivered)	≤100mΩ/28 V/100mA

\* Guide values

## Standard coils for direct current (other voltages on request)

Nominal voltage VDC	Min. pick-up voltage at 20°C	Drop-out voltage at 20°C	Nominal current in mA	Resistance in Ohm at 20°C	Tolerance in %
5	3,75	≥ 0,5	72,0	69,4	± 10
6	4,5	≥ 0,6	60,0	100	± 10
9	6,75	≥ 0,9	40,0	225	± 10
12	9,0	≥ 1,2	30,0	400	± 10
18	13,5	≥ 1,8	20,0	900	± 10
24	18,0	≥ 2,4	15,0	1'600	± 10
48	36,0	≥ 3,6	7,5	6'400	± 13
60	45,0	≥ 4,5	6,0	10'000	± 15

## Ordering example

**SIR 3 1 2 24VDC SEN**

- Sensitive coil
- Coil voltage
- Soldering tags
- Number of NC contacts
- Number of NO contacts
- Type designation

## General data

### Circuit diagram (view on relay upper side)

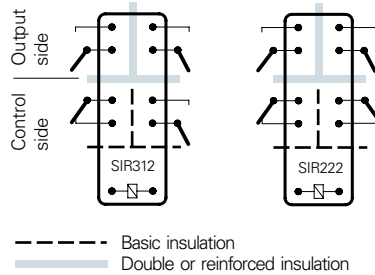

Mechanical life	> 10 x 10 <sup>6</sup> operations
Switching frequency, mechanical	15Hz
Response time	typically 18ms
Drop-out time**	typically 5ms
Bounce time of NO contact	typically 6ms
Bounce time of NC contact	typically 12ms
Shock resistance	16ms NO contact > 10g NC contact 6g
Vibration resistance	NO contact > 5g 10-200Hz NC contact 1,5g
Test voltage	coil/control contacts 2'500Veff 1min Test voltage 5'000Veff 1min coil-control contacts/output contacts Test voltage output contacts
as against each other	4'000Veff 1min
Test voltage contact open	1'500Veff 1min
Insulation resistance	10 <sup>11</sup> Ω
Creepage resistance	CTI 250
Weight	approx. 30g
Mounting position	any
Ambient temperature	-40°C to +70°C
Type of protection	RT II
Solder bath temperature	270 °C/5s
Thermal resistance	55K/W
Temperature limit for coil	120°C
Pollution degree	2
Overvoltage category	III
Resistance to short circuiting	1'000A SCPD 10A gG (pre-fuse)

\*\* without spark suppression

### Insulation terms

Coil to control contacts: Basic insulation  
Coil/control contacts to output contacts:  
Double or reinforced insulation > 10mm  
Output contacts as against each other:  
Double or reinforced insulation > 8mm

### Tests, regulations

Approvals	SEV, UL, cUL, TÜV
UL File E188953	Sec. 3
Insulation class IEC 60664-1	250VAC
Protection class II	VDE 0106
Fire protection requirements	UL 94 / V0

### Options, accessories

PCB socket see page 31

## Diagrams

### Contact lifetime

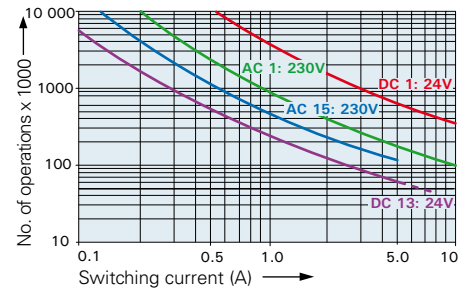

Max. switching characteristics

(determined acc. to DIN EN 60947-5-1 table C2):

AC 15: 230V/5A

DC 13: 24V/7.5A/0.1 Hz

UL 508: C600/R300

Maximal contact load at AC 1 with 230V:

2 contacts each with 10A

3 contacts each with 8.4A

### Load limit curve with direct current

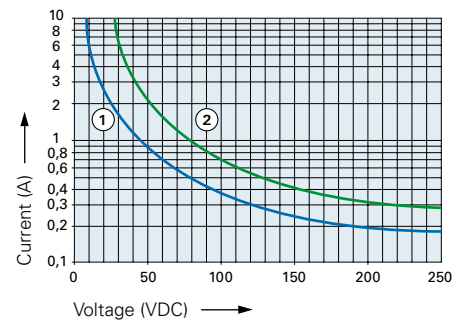

1) Inductive load, L/R 40 ms

2) Resistive load

### Excitation voltage range

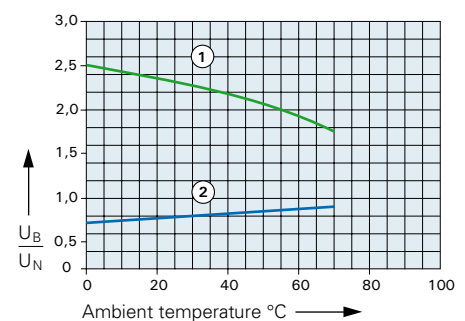

1) Max. excitation voltage with contact load ≤ 2A

2) Min. excitation voltage (guaranteed values) without previous operation

No heat accumulation due to intrinsic heating of other components.

Continuous duty 100%.



## Relay data

- PCB relay with forcibly guided contacts
- Protective separation between coil/control contacts and output contacts (> 10mm) and output contacts side by side (> 8mm)
- EN 50205, type A
- Contact mounting:  
SIR312P „Power“ Control contacts 1NO/1NC  
Output contacts 2NO  
SIR222P „Power“ Control contacts 2NC  
Output contacts 2NO
- Inrush current 60A / continuous current 12A
- Mean coil power 0.75W
- Holding power 0.23 W

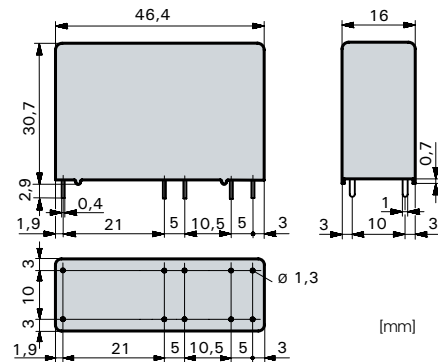

### Control Contacts

Contact material	AgSnO <sub>2</sub> +0.2µm Au
Rated switching capacity	250VAC 6A AC1 1'500VA
Electr. life AC1 (360 cycles/h)	approx. 100'000
Inrush current max.	15A for 20ms
Switching voltage range	5 to 250 VDC/VAC
Switching current range*	5mA to 6A
Switching capacity range*	60mW to 1'500W (VA)
Contact resistance (as delivered)	≤100mΩ/28V/100mA

\* Guide values

### Output contacts

Contact material	AgSnO <sub>2</sub>
Rated switching capacity	250VAC (440VAC) 12A AC1 3'000VA
Electr. life AC1 (360 cycles/h)	approx. 250'000
Inrush current max.	60A for 20ms
Switching voltage range	5 to 480 VDC/VAC
Switching current range*	10mA to 12A
Switching capacity range*	120mW to 3'000W (VA)
Contact resistance (as delivered)	≤100mΩ/28V/100mA

\* Guide values

### Standard coils for direct current (examples) other voltages on request

Nominal voltage VDC	Min. pick-up voltage at 20°C VDC	Drop-out voltage at 20°C VDC	Nominal current in mA	Resistance in Ohm at 20 °C	Tolerance in %
5	≤ 3.5	≥ 0.5	151.0	33	± 10
12	≤ 8.4	≥ 1.2	63.1	190	± 10
18	≤ 12.6	≥ 1.8	41.6	432	± 10
20	≤ 14.0	≥ 2.0	37.7	530	± 10
24	≤ 16.8	≥ 2.4	31.5	760	± 10
48	≤ 33.6	≥ 4.8	15.7	3'050	± 10
60	≤ 42.0	≥ 6.0	12.5	4'800	± 10
110	≤ 77.0	≥ 11.0	6.8	16'000	± 15

## General data

### Circuit diagram (view on relay upper side)

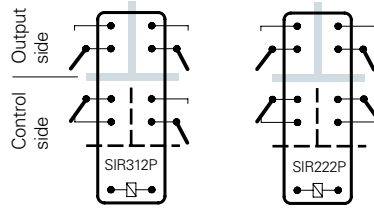

--- Basic insulation  
 — Double or reinforced insulation

Mechanical life	> 10 x 10 <sup>6</sup> operations
Switching frequency, mechanical	15Hz
Response time	typically 15ms
Drop-out time**	typically 4ms
Bounce time of NO contact	typically 6ms
Bounce time of NC contact	typically 12ms
Shock resistance	16ms
	NO contact 17g
	NC contact 7g

Vibration resistance	NO contact 10g
	NC contact 4,5g
Test voltage	
coil/control contacts	2'500Veff 1min
Test voltage	5'000Veff 1min
coil-control contacts/output contacts	
Test voltage output contacts	
as against each other	4'000Veff 1min
Test voltage contact open	1'500Veff 1min

Insulation resistance	10 <sup>11</sup> Ω
Creepage resistance	CTI 250
Weight	approx. 32g
Mounting position	any
Ambient temperature	-40°C to +70°C
Type of protection	RT II
Solder bath temperature	270 °C/5s
Thermal resistance	55K/W
Temperature limit for coil	120°C

Pollution degree	2
Overvoltage category	III
Resistance to short circuiting 1'000A SCPD 6A control contacts	gG (pre-fuse)
Resistance to short circuiting 1'000A SCPD 16A output contacts	gL/gG (pre-fuse)

\*\* without spark suppression

### Insulation terms

Coil to control contacts:	Basic insulation
Coil/control contacts to output contacts:	Double or reinforced insulation
> 10mm	
Output contacts as against each other:	Double or reinforced insulation
> 8mm	

### Tests, regulations

Approvals	SEV, UL, cUL, TÜV
UL File E188953	Sec. 3
Insulation class IEC 60664-1	250VAC
Protection class II	VDE 0106
Fire protection requirements	UL 94 / V0

### Options, accessories

PCB socket: see page 31

## Diagrams

### contacts each with (output contacts)

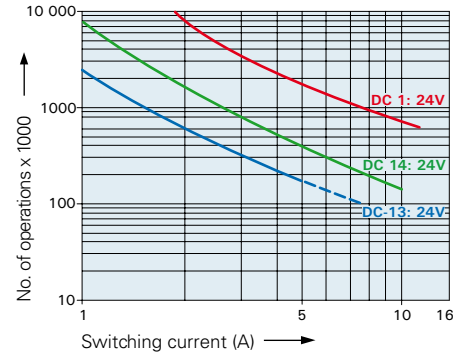

### Contact lifetime (output contacts)

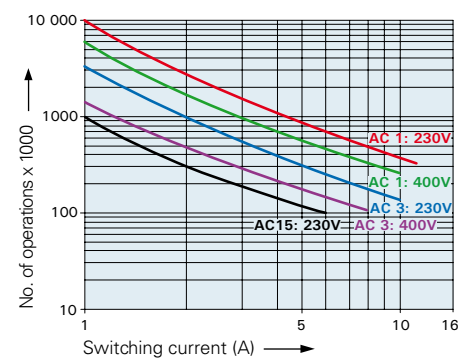

Maximal contact load at AC 1 with 230V:  
2 contacts each with 12A

### Excitation voltage range

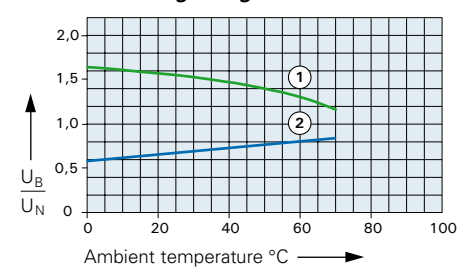

- 1) Max. excitation voltage with contact load ≤ 2A control contacts / ≤ 10A output contacts
- 2) Min. excitation voltage (guaranteed values) without previous operation

No heat accumulation due to intrinsic heating of other components.  
Continuous duty 100%.

### Ordering example

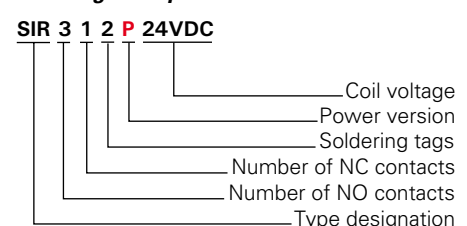



## Relay data

- PCB relay with forcibly guided contacts
- Protective separation between coil/control contacts and output contacts (> 10mm) as well as protective separation between the output contacts themselves (> 8mm)
- EN 50205, type A
- Contact mounting:  
SIR332 3NO/3NC  
SIR422 4NO/2NC  
SIR512 5NO/1NC
- Small external dimensions
- Mean coil power 0.75W
- Holding power 0.22W
- For Railway Applications: EN 50155

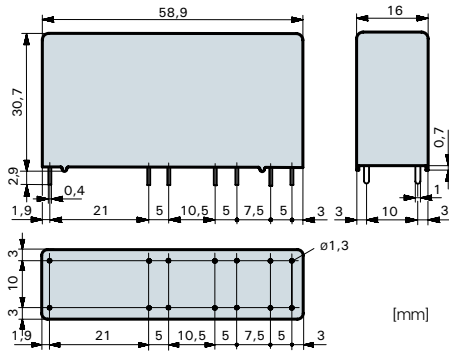

Contact material	AgSnO <sub>2</sub> +0.2µm Au
Type of contact	Crest contact
Rated switching capacity	250VAC 10A AC1 2'500VA
Electr. life AC1 (360 cycles/h)	approx. 100'000
Inrush current max.	25A for 20ms
Switching voltage range	5 to 250 VDC/VAC
Switching current range*	10mA to 10A
Switching capacity range* 0.06VA(W)	to 2'500VA
Contact resistance (as delivered)	<100mΩ/28 V/100mA

\* Guide values

## Standard coils for direct current (other voltages on request)

Nominal voltage VDC	Min. pick-up voltage at 20°C	Drop-out voltage at 20 °C	Nominal current in mA	Resistance in Ohm at 20 °C	Tolerance in %
5	3,5	≥ 0,5	151,0	33	± 10
6	4,2	≥ 0,6	125	48	± 10
12	8,4	≥ 1,2	63,1	190	± 10
18	12,6	≥ 1,8	41,6	432	± 10
24	16,8	≥ 2,4	31,5	760	± 10
48	33,6	≥ 4,8	15,7	3'050	± 10
60	42,0	≥ 6,0	12,5	4'800	± 13
110	77,0	≥ 11,0	6,8	16'000	± 15

## Ordering example

**SIR 4 2 2 24VDC**

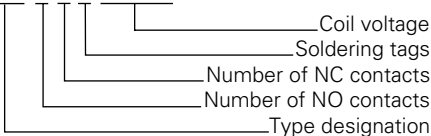

## General data

### Circuit diagram (view on relay upper side)

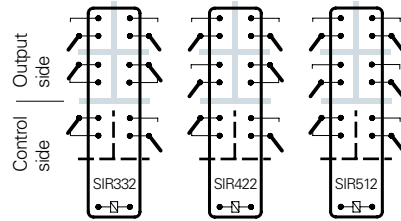

--- Basic insulation  
 Double or reinforced insulation

Mechanical life	> 10 x 10 <sup>6</sup> operations
Switching frequency, mechanical	15Hz
Response time	typically 15ms
Drop-out time**	typically 4ms
Bounce time of NO contact	typically 6ms
Bounce time of NC contact	typically 12ms
Shock resistance	16ms NO contact > 10g NC contact 6g
Vibration resistance	10-200Hz NO contact > 5g NC contact 2g
Test voltage coil/control contacts	2'500Veff 1min
Test voltage coil-control contacts/output contacts	5'000Veff 1min
Test voltage output contacts as against each other	4'000Veff 1min
Test voltage contact open	1'500Veff 1min
Insulation resistance	10 <sup>11</sup> Ω
Creepage resistance	CTI 250
Weight	approx. 35g
Mounting position	any
Ambient temperature	-40°C to +70°C
Type of protection	RT II
Solder bath temperature	270 °C/5s
Thermal resistance	55K/W
Temperature limit for coil	120°C
Pollution degree	2
Overvoltage category	III
Resistance to short circuiting	1'000A SCPD 10A gG (pre-fuse)

\*\* without spark suppression

### Insulation terms

Coil to control contacts:	Basic insulation
Coil/control contacts to output contacts:	Double or reinforced insulation > 10mm
Output contacts as against each other:	Double or reinforced insulation > 8mm

### Tests, regulations

Approvals	SEV, UL, cUL, TÜV
UL File E188953	Sec. 3
Insulation class IEC 60664-1	250VAC
Protection class II	VDE 0106
Fire protection requirements	UL 94 / V0

### Options, accessories

PCB socket	see page 31
------------	-------------

## Diagrams

### Contact lifetime

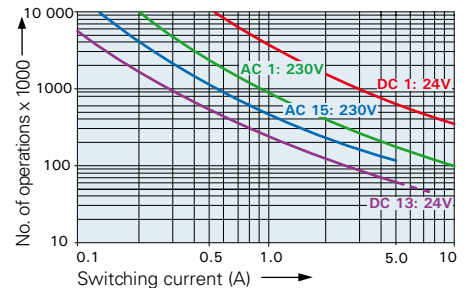

Max. switching characteristics (determined acc. to DIN EN 60947-5-1 table C2):  
 AC 15: 230V/5A  
 DC 13: 24V/7.5A/0.1 Hz  
 UL 508: C600/R300

Maximal contact load at AC 1 with 230V:

- 2 contacts each with 10A
- 3 contacts each with 8.4A
- 4 contacts each with 7.3A
- 5 contacts each with 6A

### Load limit curve with direct current

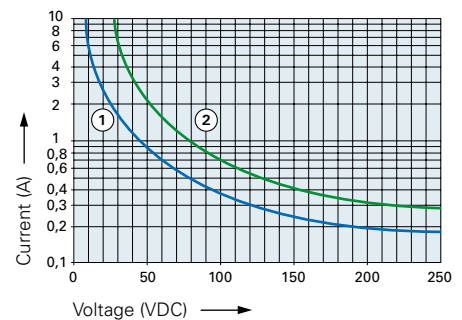

- 1) Inductive load, L/R 40 ms
- 2) Resistive load

### Excitation voltage range

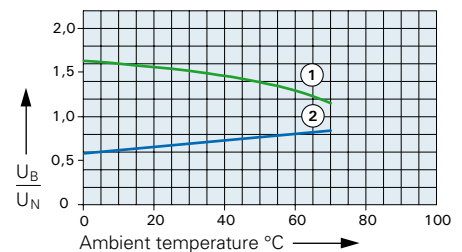

- 1) Max. excitation voltage with contact load ≤ 2A
- 2) Min. excitation voltage (guaranteed values) without previous operation

No heat accumulation due to intrinsic heating of other components.  
 Continuous duty 100%.









## Relay data

- PCB relay with forcibly guided contacts
- Protective separation between coil/control contacts and output contacts (> 8mm) and output contacts in one row (> 8mm) and as left to right contact side (> 10mm)
- EN 50205, type A
- Contact mounting:
  - SIR372 3NO/7NC SIR462 4NO/6NC
  - SIR552 5NO/5NC SIR642 6NO/4NC
  - SIR732 7NO/3NC SIR822 8NO/2NC
  - SIR912 9NO/1NC
- Small external dimensions
- Mean coil power 1.3W
- Holding power 0.39W

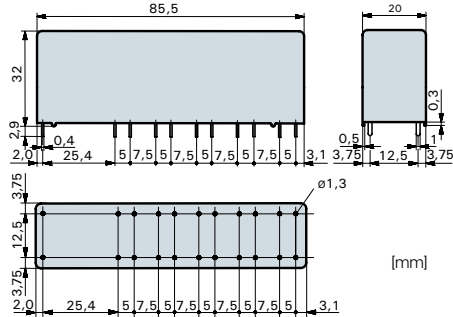

Contact material	AgSnO <sub>2</sub> +0.2µm Au
Type of contact	Crest contact
Rated switching capacity	250VAC 10A AC1 2'500VA
Electr. life AC1 (360 cycles/h)	approx. 100'000
Inrush current max.	25A for 20ms
Switching voltage range	5 to 250 VDC/VAC
Switching current range*	10mA to 10A
Switching capacity range*	0.06VA(W) to 2'500VA
Contact resistance (as delivered)	<100mΩ/28 V/100mA

\* Guide values

## Standard coils for direct current (other voltages on request)

Nominal voltage VDC	Min. pick-up voltage at 20°C	Drop-out voltage at 20°C	Nominal current in mA	Resistance in Ohm at 20 °C	Tolerance in %
6	4,2	≥ 0,6	218	275	± 10
12	8,4	≥ 1,2	109	110	± 10
18	12,6	≥ 1,8	72	250	± 10
24	16,8	≥ 2,4	54,5	440	± 10
48	33,6	≥ 4,8	27,2	1'760	± 10
60	42,0	≥ 6,0	11,8	2'750	± 10
110	77,0	≥ 11,0	6,8	9'250	± 13
220	154,0	≥ 22,0	5,9	37'000	± 15

## Ordering example

**SIR 5 5 2 24VDC**

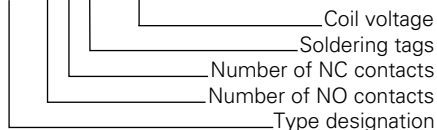

## General data

### Circuit diagram (view on relay upper side)

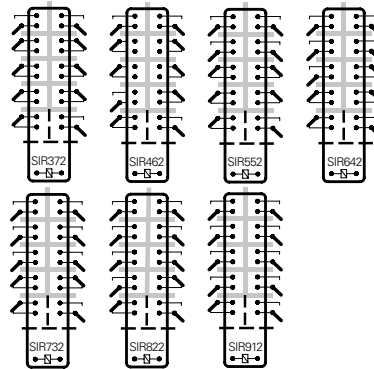

--- Basic insulation  
 — Double or reinforced insulation

Mechanical life	> 10 x 10 <sup>6</sup> operations
Switching frequency, mechanical	15Hz
Response time	typically 18ms
Drop-out time**	typically 5ms
Bounce time of NO contact	typically 8ms
Bounce time of NC contact	typically 12ms
Shock resistance	16ms NO contact > 10g NC contact 8g
Vibration resistance	10-200Hz NO contact > 10g NC contact 5g

Test voltage	coil/control contacts 2'500Veff 1min
Test voltage	coil-control contacts/output contacts 5'000Veff 1min
Test voltage output contacts	as against each other 4'000Veff 1min
Test voltage contact open	1'500Veff 1min
Insulation resistance	10 <sup>11</sup> Ω
Creepage resistance	CTI 250
Weight	approx. 60g
Mounting position	any
Ambient temperature	-40°C to +70°C
Type of protection	RT II
Solder bath temperature	270 °C/5s
Thermal resistance	40K/W
Temperature limit for coil	125°C
Pollution degree	2
Oversvoltage category	III
Resistance to short circuiting output contacts	1'000A SCPD 10A gG (pre-fuse)

\*\* without spark suppression

### Insulation terms

Coil to control contacts: Basic insulation  
 Coil/control contacts to output contacts: Double or reinforced insulation > 8mm  
 All output contacts in one row: Double or reinforced insulation > 8mm  
 All output contacts as left to right contact side: Double or reinforced insulation > 10mm

### Tests, regulations

Approvals	SEV, UL, cUL, TÜV
UL File E188953	Sec. 3
Insulation class IEC 60664-1	250VAC
Protection class II	VDE 0106
Fire protection requirements	UL 94 / V0

## Diagrams

### Contact lifetime

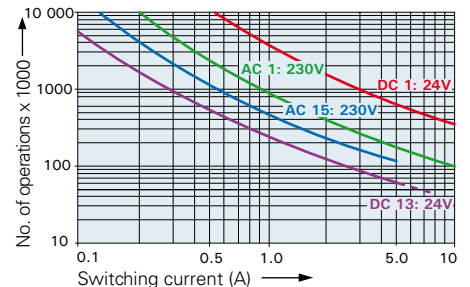

Max. switching characteristics (determined acc. to DIN EN 60947-5-1 table C2):  
 AC 15: 230V/5A  
 DC 13: 24V/7.5A/0.1 Hz  
 UL 508: C600/R300

Maximal contact load at AC 1 with 230V:  
 2 contacts each with 10A  
 3 contacts each with 8.4A  
 4 contacts each with 7.3A  
 5 contacts each with 6.5A  
 6 contacts each with 6A  
 8 contacts each with 5A  
 9 contacts each with 4.2A

### Load limit curve with direct current

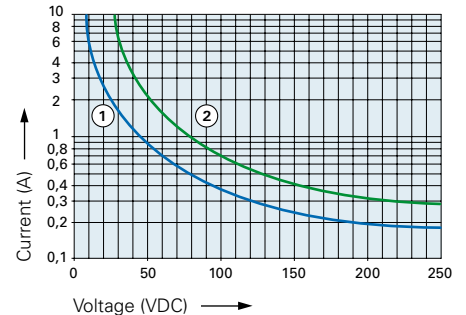

- 1) Inductive load, L/R 40 ms
- 2) Resistive load

### Excitation voltage range

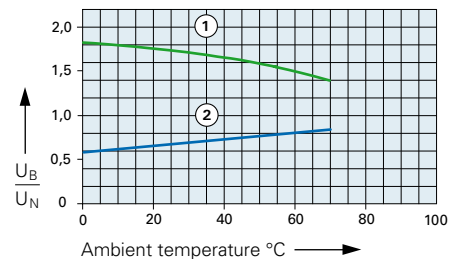

- 1) Max. excitation voltage with contact load ≤ 2A
- 2) Min. excitation voltage (guaranteed values) without previous operation

No heat accumulation due to intrinsic heating of other components.  
 Continuous duty 100%.



## Relay data

- PCB relay with forcibly guided contacts
- Protective separation between coil/control contacts and output contacts (> 8mm) and output contacts in one row (> 8mm).
- EN 50205, type A
- Contact mounting:  
SIP512 Control contacts 1NO/1NC  
Output contacts 4NO  
SIP422 Control contacts 2NC  
Output contacts 4NO
- Small external dimensions
- Mean coil power 1.3W
- Holding power 0.39W
- For Railway Applications: EN 50155

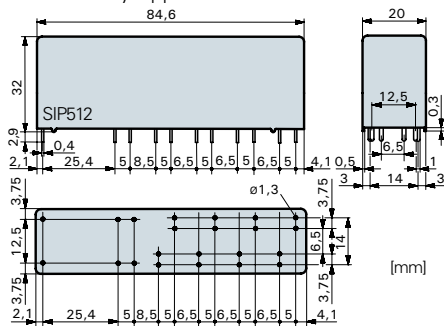

### Control contacts

Contact material	AgSnO <sub>2</sub> +0.2µm Au
Rated switching capacity	250VAC 6A AC1 1'500VA
Electr. life AC1 (360 cycles/h)	approx. 100'000
Inrush current max.	15A for 20ms
Switching voltage range	5 to 250 VDC/VAC
Switching current range*	5mA to 6A
Switching capacity range* 0.06VA(V) to 1'500VA	
Contact resistance (as delivered)	≤100mΩ/28 V/100mA

### Output contacts

Contact material	AgSnO <sub>2</sub>
Rated switching capacity	250VAC (440VAC) 16A AC1 4'000VA
Electr. life AC1 (360 cycles/h)	approx. 250'000
Inrush current max.	60A for 20ms
Switching voltage range	5 to 480 VDC/VAC
Switching current range*	10mA to 16A
Switching capacity range* 0.12VA(V) to 4'000VA	
Contact resistance (as delivered)	≤ 100mΩ/28V/100mA

\* Guide values

### Standard coils for direct current (other voltages on request)

Nominal voltage VDC	Min. pick-up voltage at 20°C	Drop-out voltage at 20°C	Nominal current in mA	Resistance in Ohm at 20°C	Tolerance in %
6	4,2	≥ 0,6	218	275	± 10
12	8,4	≥ 1,2	109	110	± 10
18	12,6	≥ 1,8	72,5	248	± 10
24	16,8	≥ 2,4	54,5	440	± 10
48	33,6	≥ 4,8	27,2	1'760	± 10
60	42,0	≥ 6,0	11,8	2'750	± 10
110	77,0	≥ 11,0	6,8	9'250	± 13
220	154,0	≥ 22,0	5,9	37'000	± 15

## General data

### Circuit diagram (view on relay upper side)

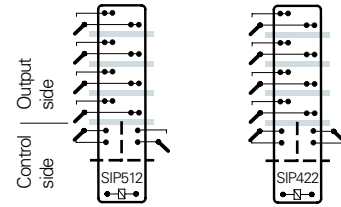

- - - Basic insulation
- ▬ Double or reinforced insulation

Mechanical life	> 10 x 10 <sup>6</sup> operations
Switching frequency, mechanical	15Hz
Response time	typically 18ms
Drop-out time**	typically 5ms
Bounce time of NO contact	typically 8ms
Bounce time of NC contact	typically 12ms
Shock resistance 16ms	NO contact > 10g NC contact 8g
Vibration resistance	NO contact > 10g 10-200Hz NC contact 5g
Test voltage coil/control contacts 2'500Veff 1min	
Test voltage coil-control contacts/output contacts	5'000Veff 1min
Test voltage output contacts as against each other	4'000Veff 1min
Test voltage contact open	1'500Veff 1min
Insulation resistance	10 <sup>11</sup> Ω
Creepage resistance	CTI 250
Weight	approx. 60g
Mounting position	any
Ambient temperature	-40°C to +70°C
Type of protection	RT II
Solder bath temperature	270°C/5s
Thermal resistance	40K/W
Temperature limit for coil	125°C
Pollution degree	2
Overvoltage category	III
Resistance to short circuiting control contacts	1'000A SCPD 6A gG (pre-fuse)
Resistance to short circuiting output contacts	1'000A SCPD 16A gG (pre-fuse)

\*\* without spark suppression

### Insulation terms

Coil to control contacts:	Basic insulation
Coil/control contacts to output contacts:	Double or reinforced insulation > 8mm
All output contacts in one row:	Double or reinforced insulation > 8mm

### Tests, regulations

Approvals	SEV, UL, cUL, TÜV
UL File E188953	Sec. 4
Insulation class IEC 60664-1	250VAC
Protection class II	VDE 0106
Fire protection requirements	UL 94 / V0

## Diagrams

### Contact lifetime (output contacts)

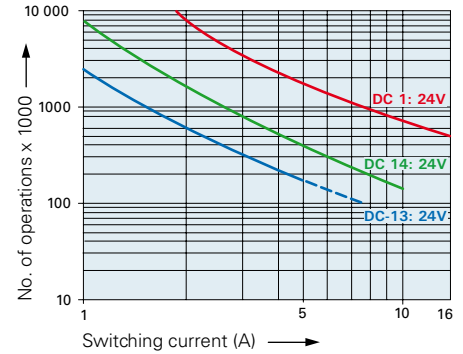

### Contact lifetime (output contacts)

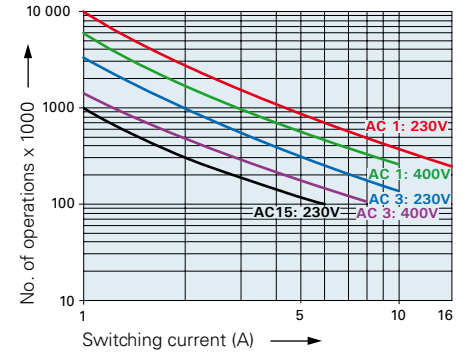

UL 508: A600/R150

Maximal contact load at AC 1 with 230V:

- 2 contacts each with 16A
- 3 contacts each with 12A
- 4 contacts each with 10A

### Excitation voltage range

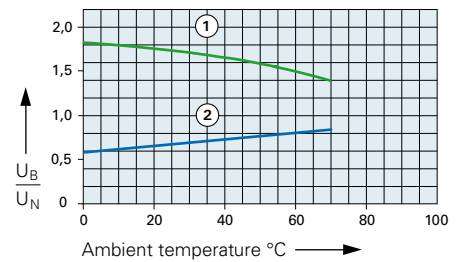

- 1) Max. excitation voltage with contact load: Control contacts ≤2A, output contacts ≤5A
- 2) Min. excitation voltage (guaranteed values) without previous operation

No heat accumulation due to intrinsic heating of other components.  
Continuous duty 100%.

### Ordering example

SIP 4 2 2 24VDC

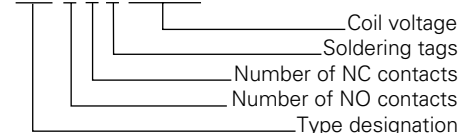



## PCB socket SRP-SGR2

- PCB socket for SGR282Z, SIR282
- With hold down clip
- Soldering tags for PCB
- 2.5mm pinning

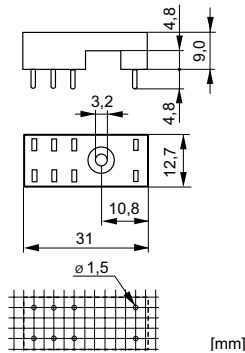

### Technical data

Rated current	2x8A
Rated voltage	300VAC
Test voltage coil/contacts	5'000Veff
Insulation class (IEC 60664-1)	250VAC
Creepage resistance	CTI 250
Weight	approx. 4g
Ambient temperature	-40°C to +80°C
Packing unit	100 pcs
Approvals	UL, cUL
UL File	E113714

## DIN rail socket SRD-SGR2

- DIN rail socket for SGR282Z, SIR282
- With plastic grip and marking tag (1 pc)
- Screw terminals
- 5mm pinning
- Assembly on DIN rail 35mm or single-hole mounting with M3 screw

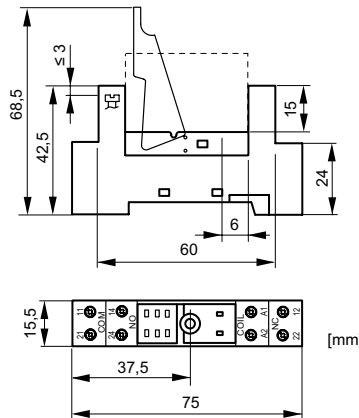
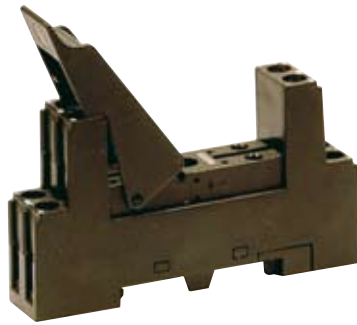

### Technical data

Rated current	2x8A
Rated voltage	300VAC
Test voltage coil/contacts	4'000Veff
Insulation class (IEC 60664-1)	250VAC
Creepage resistance	CTI 250
Weight	approx. 40g
Ambient temperature	-25°C to +80°C
Cross sections for connection with	
- wires	2x2.5mm <sup>2</sup>
- end sleeves for strands	2x1.5mm <sup>2</sup>
Torque max.	0,8 Nm
Packing unit	20 pcs
Approvals	UL, cUL
UL File	E113714

## Modules for DIN rail sockets

### Module SRD-SGR2-M01

- For DIN rail socket SRD-SGR2
- Diode 6VDC to 230VDC (+ on terminal A1)

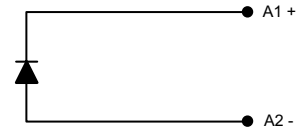

### Module SRD-SGR2-M02

- For DIN rail socket SRD-SGR2
- Diode with red Led, 6VDC to 24VDC (+ on terminal A1)

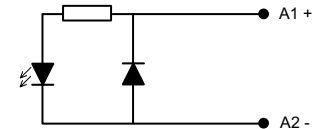

### Module SRD-SGR2-M03

- For DIN rail socket SRD-SGR2
- Diode with green Led, 6VDC to 24VDC (+ on terminal A1)

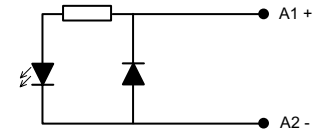

### Module SRD-SGR2-M04

- For DIN rail socket SRD-SGR2
- Red Led, 6VDC to 24VDC (+ on terminal A1)

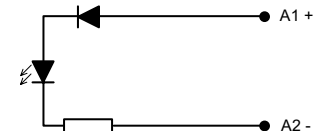

### Module SRD-SGR2-M05

- For DIN rail socket SRD-SGR2
- Green Led, 6VDC to 24VDC (+ on terminal A1)

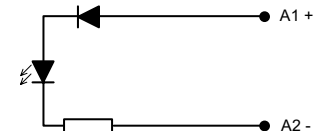



## PCB socket SRP-SIM4

- PCB socket for SIM 3 and 4 Contacts
- With integrated retaining/ejector handles
- Soldering tags for PCB

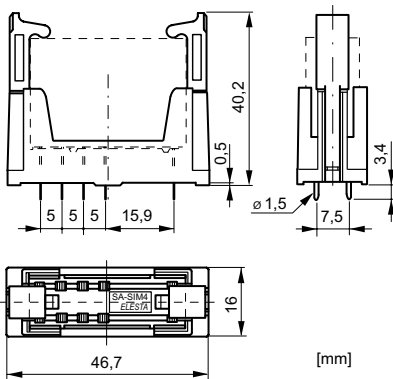

### Technical data

Rated current	8A
Rated voltage	250VAC
Test voltage coil/contacts	4'000Veff
Insulation class (IEC 60664-1)	250VAC
Creepage resistance	CTI 250
Weight	approx. 11g
Ambient temperature	-25°C to +70°C
Packing unit	20 pcs
Approvals	UL, cUL
UL File E301947	

## DIN rail socket SRD-SIM4

- DIN rail socket for SIM 3 and 4 Contacts
- With integrated retaining/ejector handles
- Screw terminals
- Assembly on DIN rail 35mm or with 2xM3 screws

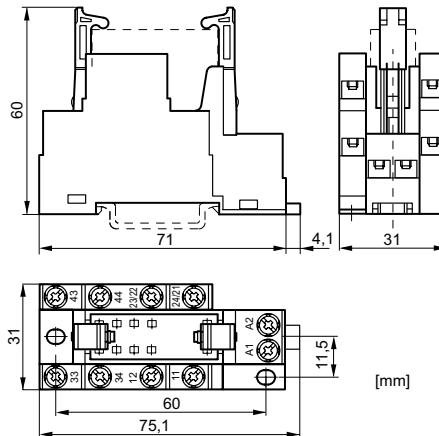
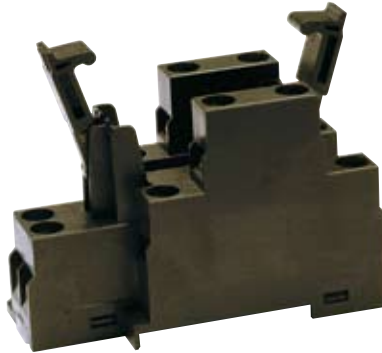

### Technical data

Rated current	8A
Rated voltage	250VAC
Test voltage coil/contacts	2'500Veff
Insulation class (IEC 60664-1)	250VAC
Creepage resistance	CTI 250
Weight	approx. 65g
Ambient temperature	-25°C to +70°C
Cross sections for connection with	
- wires	2x2.5mm <sup>2</sup>
- end sleeves for strands	2x1.5mm <sup>2</sup>
Torque max.	0.8 Nm
Packing unit	10 pcs
Approvals	UL, cUL
UL File E301947	

### SRD-SIM4 (SIM312...)

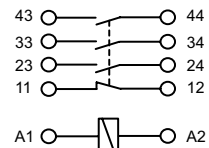

### SRD-SIM4 (SIM222...)

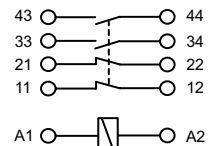



## PCB socket SRP-SIR4

- PCB socket for SIR 4 Contacts
- With integrated retaining/ejector handles
- Soldering tags for PCB

## PCB socket SRP-SIR6

- PCB socket for SIR 6 Contacts
- With integrated retaining/ejector handles
- Soldering tags for PCB

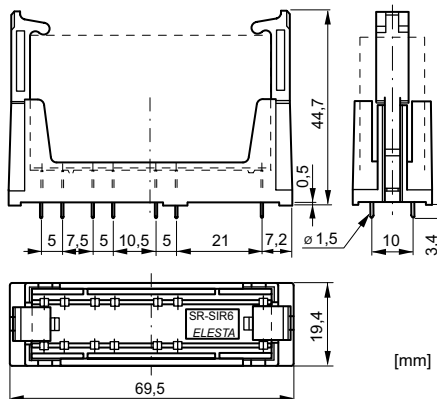
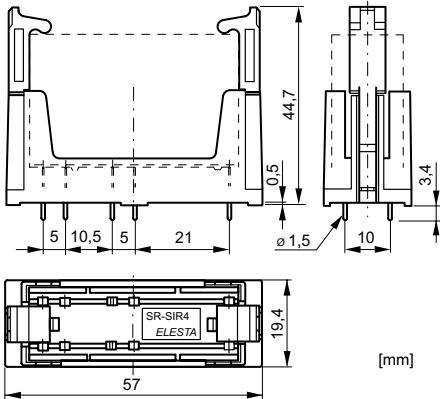
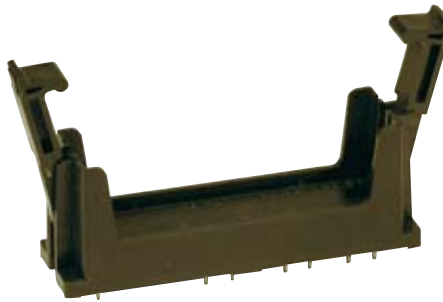

### Technical data

Rated current	8A
Rated voltage	250VAC
Test voltage coil/contacts	4'000Veff
Insulation class (IEC 60664-1)	250VAC
Creepage resistance	CTI 250
Weight	approx. 15g
Ambient temperature	-25°C to +70°C
Packing unit	20 pcs
Approvals	UL, cUL
UL File	E301947

### Technical data

Rated current	8A
Rated voltage	250VAC
Test voltage coil/contacts	4'000Veff
Insulation class (IEC 60664-1)	250VAC
Creepage resistance	CTI 250
Weight	approx. 17g
Ambient temperature	-25°C to +70°C
Packing unit	20 pcs
Approvals	UL, cUL
UL File	E301947

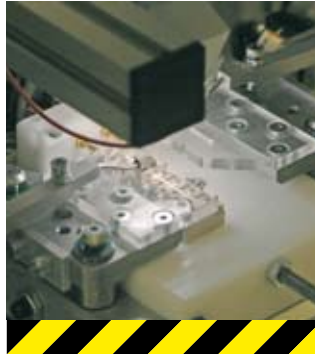
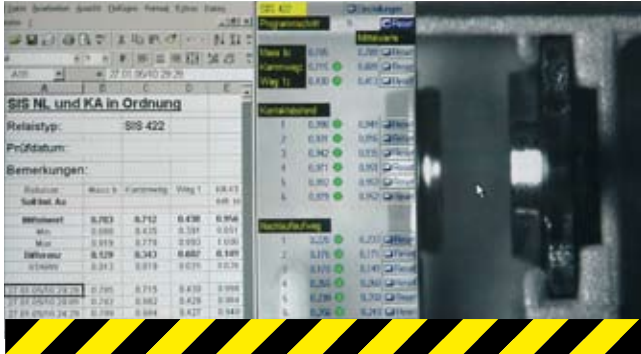

Being specialized in the production of safety relays, we protect humans and equipment alike and assume a particular responsibility for our products. Every employee of ELESTA relays GmbH is aware of this obligation in his/her daily work. In numerous recorded inspection steps from the incoming materials over the production process with 100% checking right to dispatch we guarantee the safety and product quality required for relays with forcibly guided contacts – for the benefit of man and machine!



Production mostly on the premises, sophisticated equipment and an experienced as well as highly motivated workforce ensure that our products are of highest quality. Extremely short delivery times are possible thanks to highly flexible order processing, even when special coils and customized relay variations or supplies of samples and pilot series are concerned.

It is a matter of course for us to develop products with and for our clientele. In this way we guarantee that our customers get the right products for their specific applications.

Our innovation leadership in relays with forcibly guided contacts is evident in the development, production, logistics as well as the selection of available relays and our competent application consultancy – for the benefit of our customers!

Our process-oriented management system guarantees flat structures and short decision making. Continuous improvement processes, further education, contribution to standardizations and close contact to customers and suppliers are firmly in place. „Swiss Quality“ is a reality at ELESTA relays GmbH.





# CERTIFICATE

## RoHS

### Certificate of environmental compatibility

Compatibility with the environment is of particular importance to ELESTA relays GmbH. All materials we process, the consumables, packaging products, cleaning agents etc. we use have been selected with a view to their eco-friendliness already for many years. Careful handling of the natural resources, lowest possible energy consumption, pendulum systems for input and auxiliary materials as well as optimized recycling processes are a matter of course for us. They extend far beyond what legislation demands.

### Conformity with the EU guideline 2002/95/EG of 27 January 2003 (RoHS)

Our products comply with the legal requirements according to the EU guideline 2002/95/EG dated 27 January 2003 (RoHS: Restriction of Hazardous Substances). None of our products contain any of the substances listed below:

- **Lead, mercury, cadmium, hexavalent chromium**
- **Polybromated biphenyle (PBB), polybromated diphenyle ether (PBDE)**

### Soldering processes and suitability for the process

Our products are suitable for all common soldering processes based on higher temperatures. It is the user's responsibility, however, to check and confirm the suitability for the particular process in the individual case.

### Application consultancy

ELESTA relays GmbH offers its customers comprehensive application consultancy also in the context of the RoHS directives and the environmental compatibility of ELESTA relays products.

Bad Ragaz, 01 March 2005



Dr. Martin Kunschert  
General Manager



Markus Gloor  
Quality and Environment Manager



# CERTIFICATE

## REACH

The REACH regulation defines the safe production and use of chemical substances in the European Union. Being a Swiss producer we are not subject to the REACH regulation. ELESTA relays GmbH is a downstream user and as such does not produce any substances or formulations.

We procure all basic materials and formulations from which our products are made by suppliers who, if required, have either already registered or pre-registered the substances and materials. Our products are not liable to registration in the sense of REACH.

Based on the SVHC (Substances of Very High Concern) list of candidates, issued on October 29, 2008 and published by the ECHA (European Chemicals Agency) our products are not subject to any information duty in compliance with Article 33.1, i.e. our products do not contain any substances of the list of candidates. Should a future list of candidates show a substance contained in a product supplied by us, we shall duly inform you as specified in the regulation on chemicals.

ELESTA relays GmbH confirms that material and safety data sheets (relays and sockets) from its suppliers concerning the materials and substances used in its products are to hand and are made available by our suppliers.

Information of relevance to safety will of course be made available on request.

Bad Ragaz, February 2009



Dr. Martin Kunschert  
General Manager



Markus Gloor  
Quality and Environment Manager

**BUREAU VERITAS**  
Certification



Certificate  
for

**ELESTA relays GmbH**  
7310 Bad Ragaz / Switzerland

Bureau Veritas Certification hereby confirms that the management system of the above-mentioned organisation has been assessed and complies with the requirements set out in the following standards / regulations.

Standards/Regulations:

**SN EN ISO 9001 : 2008**

The management system comprises:

**Development, production and sales of electromechanical products**

Date of initial certification: **26.11.2008**

The requirements of the standards/regulations must be complied with throughout the period of validity of this certificate. This will be ensured through regular monitoring by Bureau Veritas Certification.

Date of certification: **26.11.2008** Valid until: **26.11.2011**

Bureau Veritas Certification will provide information on the validity of this certificate on request at any time. Additional information on the management system and the area of applicability should be obtained from the organisation itself.

Certificate number: **CH1296513** Date: **16.01.2009**  
**2<sup>nd</sup> edition**



SCESm 003



Bureau Veritas Certification (Switzerland) AG,  
Grosssäckerstrasse 25, CH-8104 Weiningen ZH



---

**Switzerland**

ELESTA relays GmbH  
Heuteilstrasse 18  
CH-7310 Bad Ragaz  
Switzerland

Phone: +41 (0)81 303 54 00  
Fax: +41 (0)81 303 54 01  
E-Mail: [admin@elestarelays.com](mailto:admin@elestarelays.com)  
Internet: <http://www.elestarelays.com>

---

**Germany**

ELESTA relays GmbH  
Sales office Frankfurt  
Grabenstraße 15  
D-63500 Seligenstadt  
Germany

Phone: +49 (0)6182 7876854  
Fax: +49 (0)6182 7876857  
E-Mail: [admin@elestarelays.com](mailto:admin@elestarelays.com)  
Internet: <http://www.elestarelays.com>

ELESTA relays GmbH  
Sales office Leipzig  
Unterer Haselberg 32  
D-04683 Nauenhof  
Germany

Phone: +49 (0)34293 473818  
Fax: +49 (0)34293 459988  
E-Mail: [admin@elestarelays.com](mailto:admin@elestarelays.com)  
Internet: <http://www.elestarelays.com>

---

**Worldwide**

See internet:

<http://www.elestarelays.com>

**Your ELESTA relays - partner:**

## **X-ON Electronics**

Largest Supplier of Electrical and Electronic Components

*Click to view similar products for [elesta](#) manufacturer:*

Other Similar products are found below :

[SIM222 12VDC](#) [SGR282ZK 24VDC](#) [SIM312 24VDC](#) [SRD-SGR2](#) [SGR282ZK 12VDC](#) [SIM222 24VDC](#)