

LM351A – 3535 Middle Power LED



Introduction

Features

- Beam Angle : 120°
- Precondition : JEDEC Level 2a
- Dimension : 3.80 x 3.55 x 0.65 mm
- ESD withstand Voltage : up to ± 5 KV [HBM]

Applications

- INDOOR LIGHTING : Down light, LED bulb, MR/Par and Ceiling Light

SAMSUNG ELECTRONICS

95, Samsung2-Ro, Giheung-Gu,
Yongin-City, Gyeonggi-Do 446-711, KOREA

Contents

1. Product Code Information	-----	3
2. Characteristics	-----	9
3. Typical Characteristics Graph	-----	10
4. Outline Drawing & Dimension	-----	16
5. Reliability Test Items & Conditions	-----	17
6. Solder Conditions	-----	18
7. Tape & Reel	-----	19
8. Label Structure	-----	20
9. Packing Structure	-----	21
10. Precaution For Use	-----	23
11. Hazard Substance Analysis Report	-----	26
12. Revision History	-----	48



1. Product Code Information

1) Luminous Flux Bins ($T_s = 25^\circ\text{C}$)

Nominal CCT	Product Code	Flux Rank	Sorting Condition $I_m @200\text{mA}$	
			Flux Bin	Flux Range (Φ_v, I_m)
2700K	SPMWHT326LD5CAW0S0	S0	S1	62.0 ~ 68.2
			S2	68.2 ~ 74.3
			S3	74.3 ~ 81.0
3000K	SPMWHT326LD5CAV0S0	S0	S1	65.0 ~ 70.9
			S2	70.9 ~ 77.2
			S3	77.2 ~ 84.2
3500K	SPMWHT326LD5CAU0S0	S0	S1	68.0 ~ 74.1
			S2	74.1 ~ 80.8
			S3	80.8 ~ 88.1
4000K	SPMWHT326LD5CAT0S0	S0	S1	70.0 ~ 76.3
			S2	76.3 ~ 83.2
			S3	83.2 ~ 90.7
5000K	SPMWHT326LD5CAR0S0	S0	S1	72.5 ~ 79.0
			S2	79.0 ~ 86.1
			S3	86.1 ~ 93.9
5700K	SPMWHT326LD5CAQ0S0	S0	S1	70.0 ~ 76.3
			S2	76.3 ~ 83.2
			S3	83.2 ~ 90.7
6500K	SPMWHT326LD5CAP0S0	S0	S1	68.5 ~ 74.7
			S2	74.7 ~ 81.4
			S3	81.4 ~ 88.7

Notes:

SAMSUNG ELECTRONICS maintains a tolerance of $\pm 5\%$ on Luminous Flux measurements

2) Color Bins ($T_s = 25^\circ\text{C}$)

(1) Color Binning

Nominal CCT	Product Code	Color Rank	Chromaticity Bins
2700K	SPMWHT326LD5CAW0S0	W0	W1, W2, W3, W4, W5, W6, W7, W8, W9, WA, WB, WC, WD, WE, WF, WG
3000K	SPMWHT326LD5CAV0S0	V0	V1, V2, V3, V4, V5, V6, V7, V8, V9, VA, VB, VC, VD, VE, VF, VG
3500K	SPMWHT326LD5CAU0S0	U0	U1, U2, U3, U4, U5, U6, U7, U8, U9, UA, UB, UC, UD, UE, UF, UG
4000K	SPMWHT326LD5CAT0S0	T0	T1, T2, T3, T4, T5, T6, T7, T8, T9, TA, TB, TC, TD, TE, TF, TG
5000K	SPMWHT326LD5CAR0S0	R0	R1, R2, R3, R4, R5, R6, R7, R8
5700K	SPMWHT326LD5CAQ0S0	Q0	Q1, Q2, Q3, Q4, Q5, Q6, Q7, Q8
6500K	SPMWHT326LD5CAP0S0	P0	P1, P2, P3, P4, P5, P6, P7, P8

(2) Chromaticity Region & Coordinates

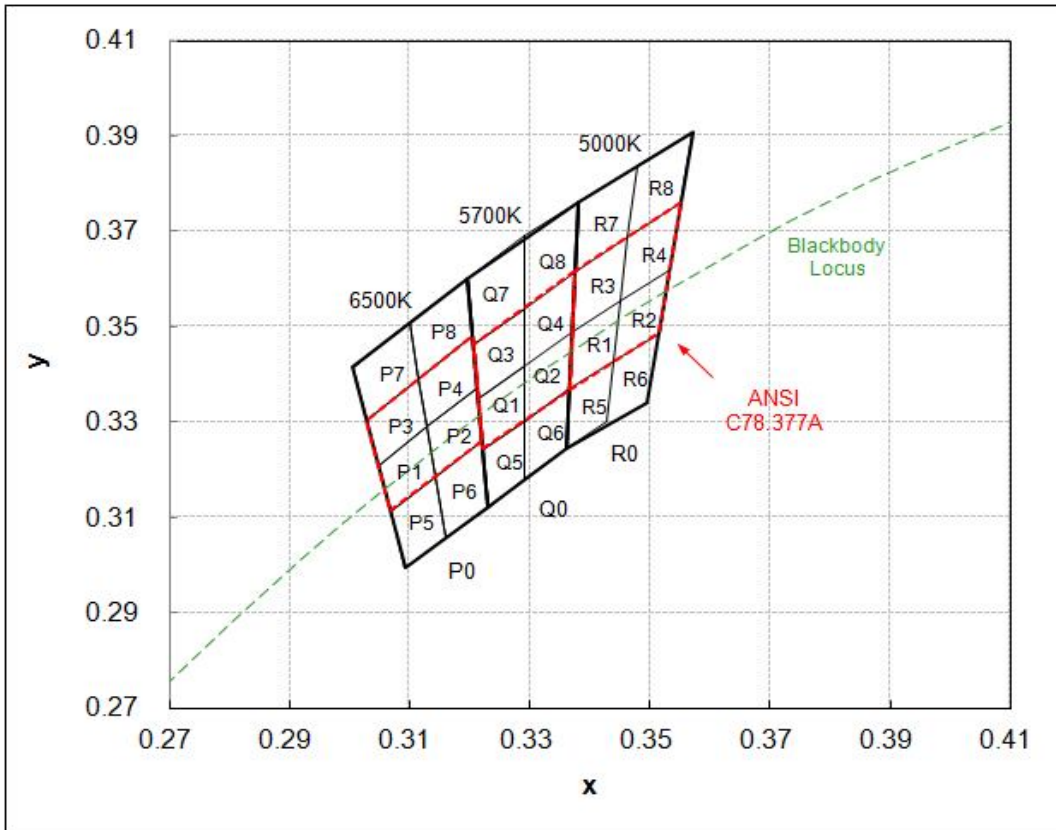
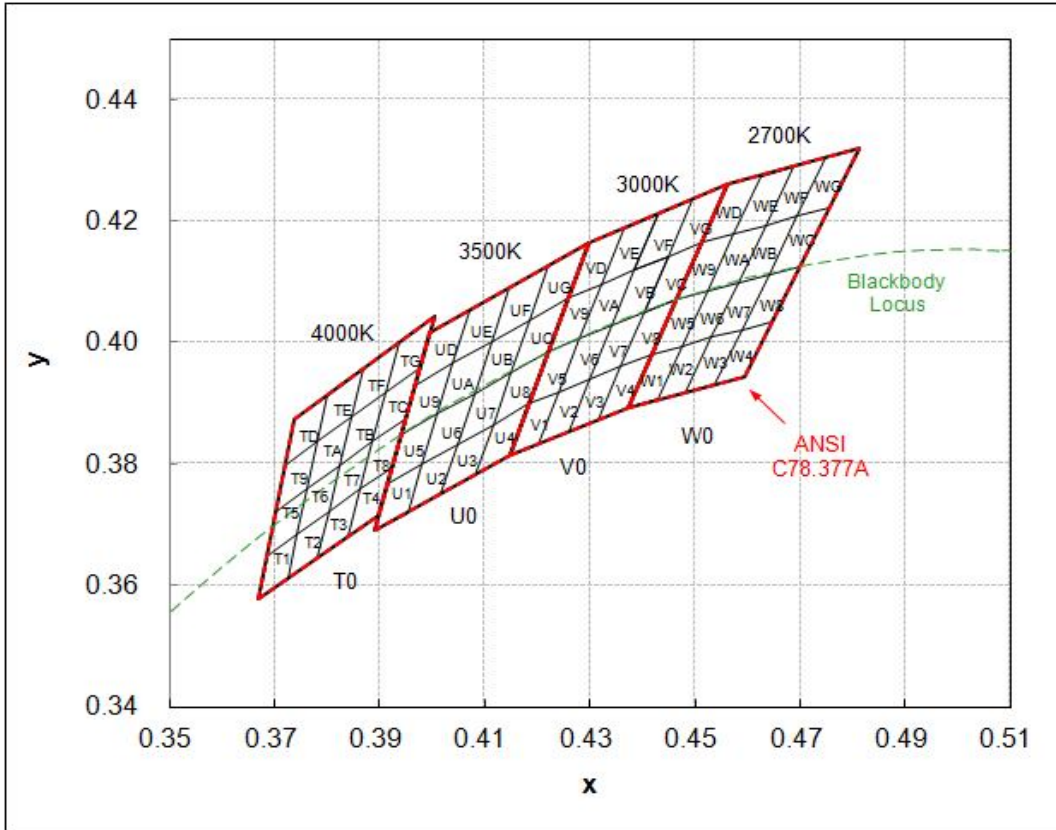

(2) Chromaticity Region & Coordinates (Continued)

Region	CIE X	CIE Y	Region	CIE X	CIE Y	Region	CIE X	CIE Y	Region	CIE X	CIE Y
W rank (2700K)						V rank (3000K)					
W1	0.4373	0.3893	W9	0.4465	0.4071	V1	0.4147	0.3814	V9	0.4221	0.3984
	0.4418	0.3981		0.4513	0.4164		0.4183	0.3898		0.4259	0.4073
	0.4475	0.3994		0.4573	0.4178		0.4242	0.3919		0.4322	0.4096
	0.4428	0.3906		0.4523	0.4085		0.4203	0.3833		0.4281	0.4006
W2	0.4428	0.3906	WA	0.4523	0.4085	V2	0.4203	0.3833	VA	0.4281	0.4006
	0.4475	0.3994		0.4573	0.4178		0.4242	0.3919		0.4322	0.4096
	0.4532	0.4008		0.4634	0.4193		0.4300	0.3939		0.4385	0.4119
	0.4483	0.3919		0.4582	0.4099		0.4259	0.3853		0.4342	0.4028
W3	0.4483	0.3919	WB	0.4582	0.4099	V3	0.4259	0.3853	VB	0.4342	0.4028
	0.4532	0.4008		0.4634	0.4193		0.4300	0.3939		0.4385	0.4119
	0.4589	0.4021		0.4695	0.4207		0.4359	0.3960		0.4449	0.4141
	0.4538	0.3931		0.4641	0.4112		0.4316	0.3873		0.4403	0.4049
W4	0.4538	0.3931	WC	0.4641	0.4112	V4	0.4316	0.3873	VC	0.4403	0.4049
	0.4589	0.4021		0.4695	0.4207		0.4359	0.3960		0.4449	0.4141
	0.4646	0.4034		0.4756	0.4221		0.4418	0.3981		0.4513	0.4164
	0.4593	0.3944		0.4700	0.4126		0.4373	0.3893		0.4465	0.4071
W5	0.4418	0.3981	WD	0.4513	0.4164	V5	0.4183	0.3898	VD	0.4259	0.4073
	0.4465	0.4071		0.4562	0.4260		0.4221	0.3984		0.4299	0.4165
	0.4523	0.4085		0.4624	0.4274		0.4281	0.4006		0.4364	0.4188
	0.4475	0.3994		0.4573	0.4178		0.4242	0.3919		0.4322	0.4096
W6	0.4475	0.3994	WE	0.4573	0.4178	V6	0.4242	0.3919	VE	0.4322	0.4096
	0.4523	0.4085		0.4624	0.4274		0.4281	0.4006		0.4364	0.4188
	0.4582	0.4099		0.4687	0.4289		0.4342	0.4028		0.4430	0.4212
	0.4532	0.4008		0.4634	0.4193		0.4300	0.3939		0.4385	0.4119
W7	0.4532	0.4008	WF	0.4634	0.4193	V7	0.4300	0.3939	VF	0.4385	0.4119
	0.4582	0.4099		0.4687	0.4289		0.4342	0.4028		0.4430	0.4212
	0.4641	0.4112		0.4750	0.4304		0.4403	0.4049		0.4496	0.4236
	0.4589	0.4021		0.4695	0.4207		0.4359	0.3960		0.4449	0.4141
W8	0.4589	0.4021	WG	0.4695	0.4207	V8	0.4359	0.3960	VG	0.4449	0.4141
	0.4641	0.4112		0.4750	0.4304		0.4403	0.4049		0.4496	0.4236
	0.4700	0.4126		0.4813	0.4319		0.4465	0.4071		0.4562	0.4260
	0.4646	0.4034		0.4756	0.4221		0.4418	0.3981		0.4513	0.4164

(2) Chromaticity Region & Coordinates (Continued)

Region	CIE X	CIE Y	Region	CIE X	CIE Y	Region	CIE X	CIE Y	Region	CIE X	CIE Y
U rank (3500K)						T rank (4000K)					
U1	0.3889	0.3690	U9	0.3941	0.3848	T1	0.367	0.3578	T9	0.3702	0.3722
	0.3915	0.3768		0.3968	0.3930		0.3726	0.3612		0.3763	0.3760
	0.3981	0.3800		0.4040	0.3966		0.3744	0.3685		0.3782	0.3837
	0.3953	0.3720		0.4010	0.3882		0.3686	0.3649		0.3719	0.3797
U2	0.3953	0.3720	UA	0.4010	0.3882	T2	0.3726	0.3612	TA	0.3763	0.3760
	0.3981	0.3800		0.4040	0.3966		0.3783	0.3646		0.3825	0.3798
	0.4048	0.3832		0.4113	0.4001		0.3804	0.3721		0.3847	0.3877
	0.4017	0.3751		0.4080	0.3916		0.3744	0.3685		0.3782	0.3837
U3	0.4017	0.3751	UB	0.4080	0.3916	T3	0.3783	0.3646	TB	0.3825	0.3798
	0.4048	0.3832		0.4113	0.4001		0.3840	0.3681		0.3887	0.3836
	0.4116	0.3865		0.4186	0.4037		0.3863	0.3758		0.3912	0.3917
	0.4082	0.3782		0.4150	0.3950		0.3804	0.3721		0.3847	0.3877
U4	0.4082	0.3782	UC	0.4150	0.3950	T4	0.384	0.3681	TC	0.3887	0.3837
	0.4116	0.3865		0.4186	0.4037		0.3898	0.3716		0.395	0.3875
	0.4183	0.3898		0.4259	0.4073		0.3924	0.3794		0.3978	0.3958
	0.4147	0.3814		0.4221	0.3984		0.3863	0.3758		0.3912	0.3917
U5	0.3915	0.3768	UD	0.3968	0.3930	T5	0.3686	0.3649	TD	0.3719	0.3797
	0.3941	0.3848		0.3996	0.4015		0.3744	0.3685		0.3782	0.3837
	0.4010	0.3882		0.4071	0.4052		0.3763	0.376		0.3802	0.3916
	0.3981	0.3800		0.4040	0.3966		0.3702	0.3722		0.3736	0.3874
U6	0.3981	0.3800	UE	0.4040	0.3966	T6	0.3744	0.3685	TE	0.3782	0.3837
	0.4010	0.3882		0.4071	0.4052		0.3804	0.3721		0.3847	0.3877
	0.4080	0.3916		0.4146	0.4089		0.3825	0.3798		0.3869	0.3958
	0.4048	0.3832		0.4113	0.4001		0.3763	0.376		0.3802	0.3916
U7	0.4048	0.3832	UF	0.4113	0.4001	T7	0.3804	0.3721	TF	0.3847	0.3877
	0.4080	0.3916		0.4146	0.4089		0.3863	0.3758		0.3912	0.3917
	0.4150	0.3950		0.4222	0.4127		0.3887	0.3836		0.3937	0.4001
	0.4116	0.3865		0.4186	0.4037		0.3825	0.3798		0.3869	0.3958
U8	0.4116	0.3865	UG	0.4186	0.4037	T8	0.3863	0.3758	TG	0.3912	0.3917
	0.4150	0.3950		0.4222	0.4127		0.3924	0.3794		0.3978	0.3958
	0.4221	0.3984		0.4299	0.4165		0.395	0.3875		0.4006	0.4044
	0.4183	0.3898		0.4259	0.4073		0.3887	0.3836		0.3937	0.4001

(2) Chromaticity Region & Coordinates (Continued)

Region	CIE X	CIE Y	Region	CIE X	CIE Y	Region	CIE X	CIE Y	Region	CIE X	CIE Y
R rank (5000K)						P rank (6500K)					
R1	0.3366	0.3369	R5	0.3373	0.3534	P1	0.3068	0.3113	P5	0.3041	0.3240
	0.3441	0.3428		0.3456	0.3601		0.3145	0.3187		0.3126	0.3324
	0.3449	0.3515		0.3464	0.3688		0.3135	0.3256		0.3117	0.3393
	0.3369	0.3451		0.3376	0.3616		0.3055	0.3177		0.3028	0.3304
R2	0.3441	0.3428	R6	0.3456	0.3601	P2	0.3145	0.3187	P6	0.3126	0.3324
	0.3515	0.3487		0.3539	0.3669		0.3221	0.3261		0.3210	0.3408
	0.3527	0.3578		0.3551	0.3760		0.3216	0.3334		0.3205	0.3481
	0.3449	0.3515		0.3464	0.3688		0.3135	0.3256		0.3117	0.3393
R3	0.3369	0.3451	R7	0.3363	0.3287	P3	0.3055	0.3177	P7	0.3081	0.3049
	0.3449	0.3515		0.3433	0.3341		0.3135	0.3256		0.3154	0.3119
	0.3456	0.3601		0.3441	0.3428		0.3126	0.3324		0.3145	0.3187
	0.3373	0.3534		0.3366	0.3369		0.3041	0.3240		0.3068	0.3113
R4	0.3449	0.3515	R8	0.3433	0.3341	P4	0.3135	0.3256	P8	0.3154	0.3119
	0.3527	0.3578		0.3503	0.3396		0.3216	0.3334		0.3226	0.3188
	0.3539	0.3669		0.3515	0.3487		0.3210	0.3408		0.3221	0.3261
	0.3456	0.3601		0.3441	0.3428		0.3126	0.3324		0.3145	0.3187
Region	CIE X	CIE Y	Region	CIE X	CIE Y						
Q rank (5700K)											
Q1	0.3222	0.3243	Q5	0.3212	0.3389						
	0.3294	0.3306		0.3292	0.3461						
	0.3293	0.3384		0.3292	0.3539						
	0.3217	0.3316		0.3207	0.3462						
Q2	0.3294	0.3306	Q6	0.3292	0.3461						
	0.3366	0.3369		0.3373	0.3534						
	0.3369	0.3451		0.3376	0.3616						
	0.3293	0.3384		0.3292	0.3539						
Q3	0.3217	0.3316	Q7	0.3227	0.3170						
	0.3293	0.3384		0.3295	0.3228						
	0.3292	0.3461		0.3294	0.3306						
	0.3212	0.3389		0.3222	0.3243						
Q4	0.3293	0.3384	Q8	0.3295	0.3228						
	0.3369	0.3451		0.3363	0.3287						
	0.3373	0.3534		0.3366	0.3369						
	0.3292	0.3461		0.3294	0.3306						

Notes: SAMSUNG ELECTRONICS maintains ± 0.005 tolerance of Cx, Cy

2. Characteristics

1) Absolute Maximum Rating

Item	Symbol	Rating	Condition
Operating temperature range	T_{op}	-40°C ~ +85°C	-
Storage temperature range	T_{stg}	-40°C ~ +100°C	-
LED junction temperature	T_J	120°C	-
Forward Current	I_F	250 mA	-
Peak Pulsed Forward Current	I_{FP}	450 mA	Duty 1/10 pulse width 10ms
Thermal resistance	$R_{th, j-s}$	20°C/W	Junction to solder point
Assembly Process Temperature	-	260°C, < 10sec	-
ESD	-	5kV	HBM

2) Electro-optical Characteristics

Item	Unit	Nominal CCT	Rank	Min	Typ	Max	
Forward Voltage ¹⁾ (V_F) (@200 mA, $T_s = 25^\circ\text{C}$)	V	-	CA	A1	3.0	-	3.1
				A2	3.1	-	3.2
				A3	3.2	-	3.3
				A4	3.3	-	3.4
				A5	3.4	-	3.5
Luminous Flux ²⁾ (Φ_v) (@200 mA, $T_s = 25^\circ\text{C}$)	lm	2700K	S0	62.0	-	81.0	
		3000K	S0	65.0	-	84.2	
		3500K	S0	68.0	-	88.1	
		4000K	S0	70.0	-	90.7	
		5000K	S0	72.5	-	93.9	
		5700K	S0	70.0	-	90.7	
6500K	S0	68.5	-	88.7			
Reverse Voltage (@5 mA, $T_s = 25^\circ\text{C}$)	V	-	-	0.7	-	1.2	
Color Rendering Index ³⁾ (R_a)	-	-	5	80	-	-	
Special CRI ⁴⁾ (R9)	-	-	-	0	-	-	

Notes:

1)~4) SAMSUNG ELECTRONICS maintains a tolerance of $V_F:\pm 0.1$ V, $\Phi_v:\pm 5$ %, $R_a : \pm 3.0$, R9 $:\pm 6.5$ on measurements

3. Typical Characteristics Graph (@200mA, $T_s = 25^\circ\text{C}$)

1) Spectrum Distribution

(1) CCT : 2700K & 3000K

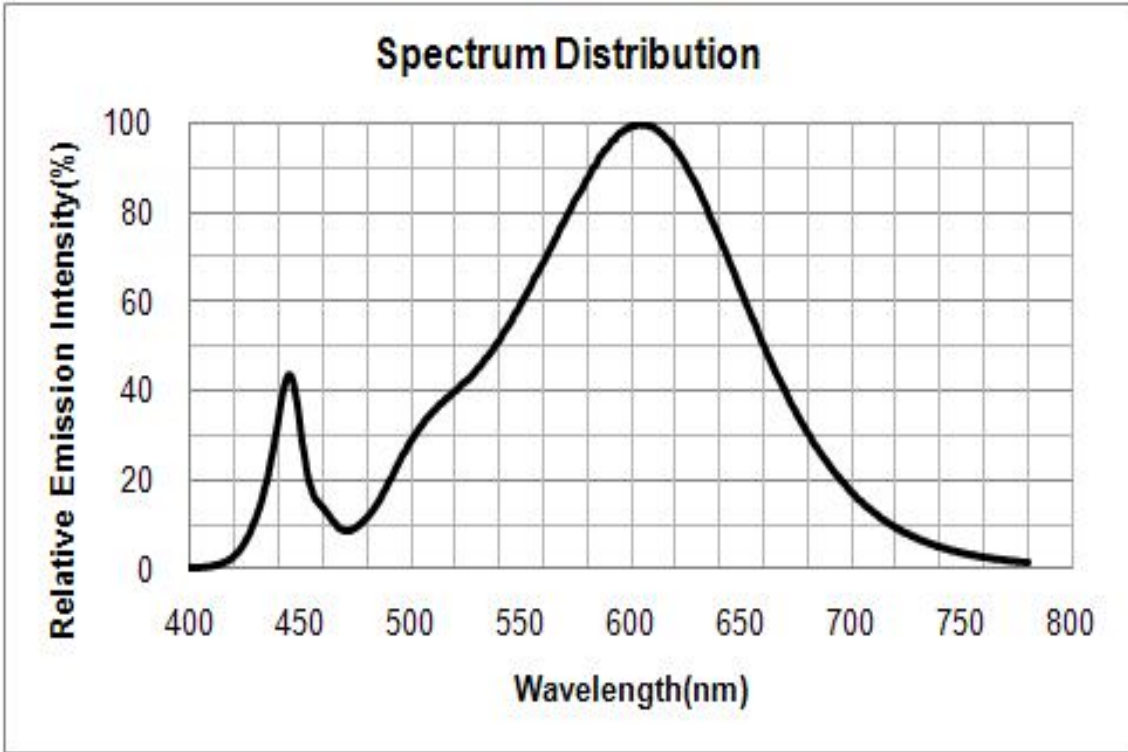

(2) CCT : 3500K & 4000K

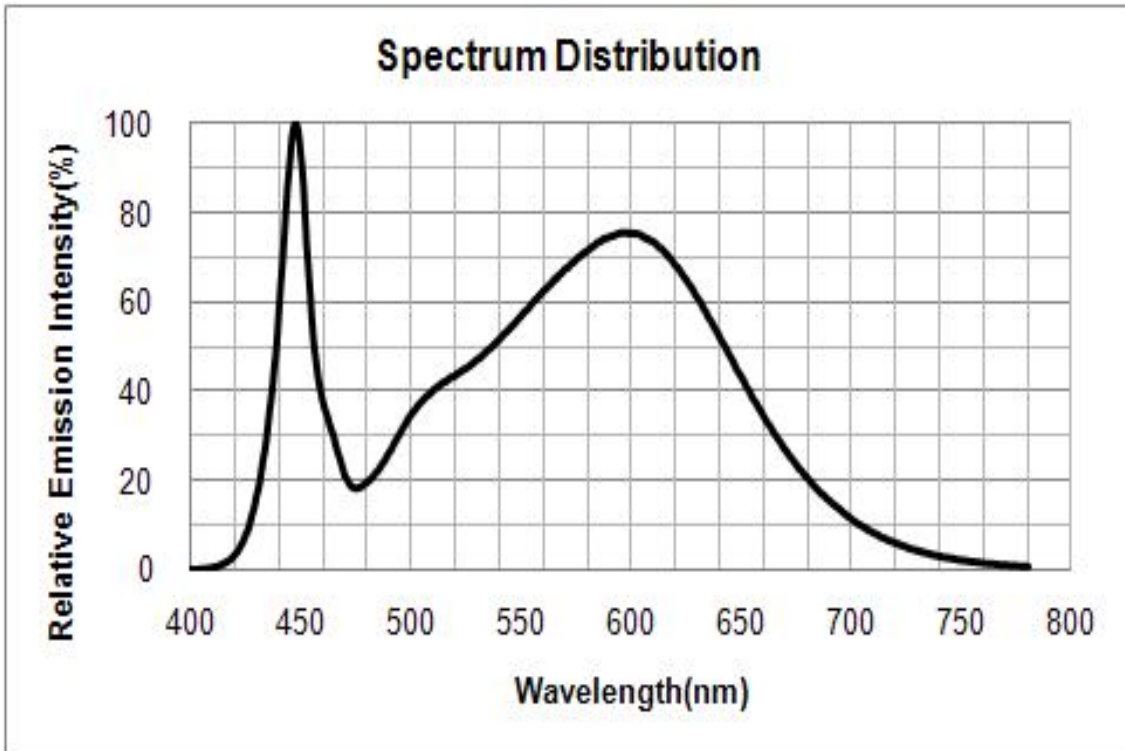

(3) CCT : 5000K

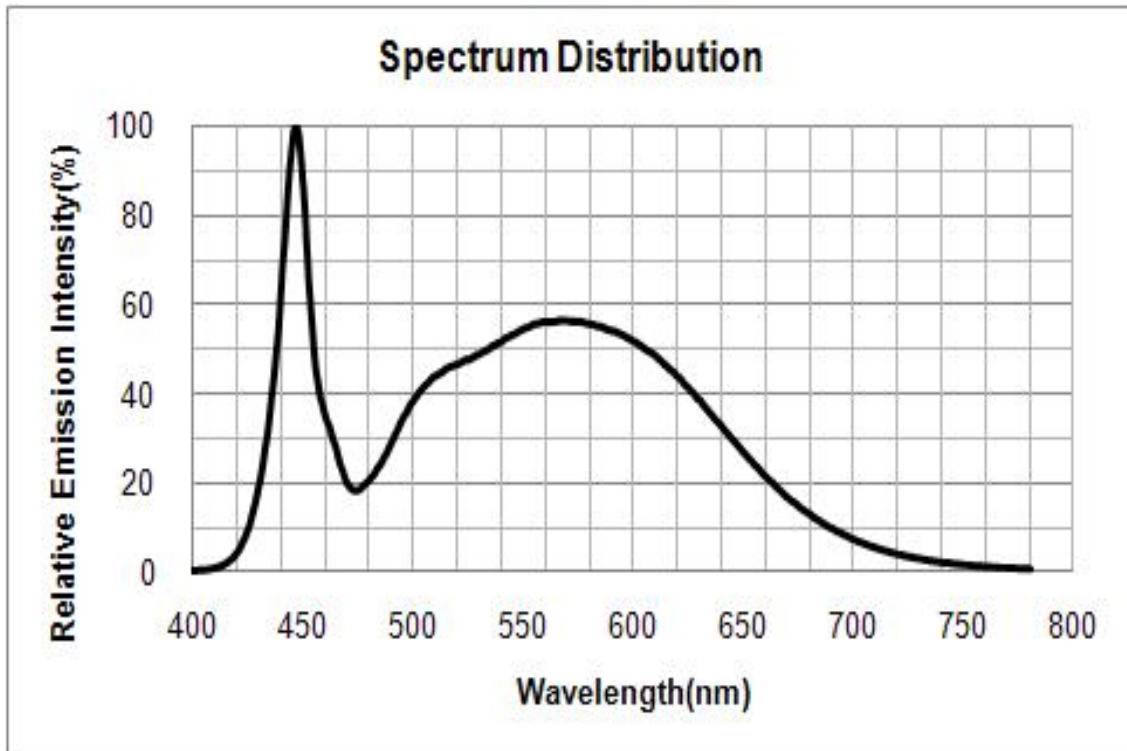

(4) CCT : 5700K & 6500K

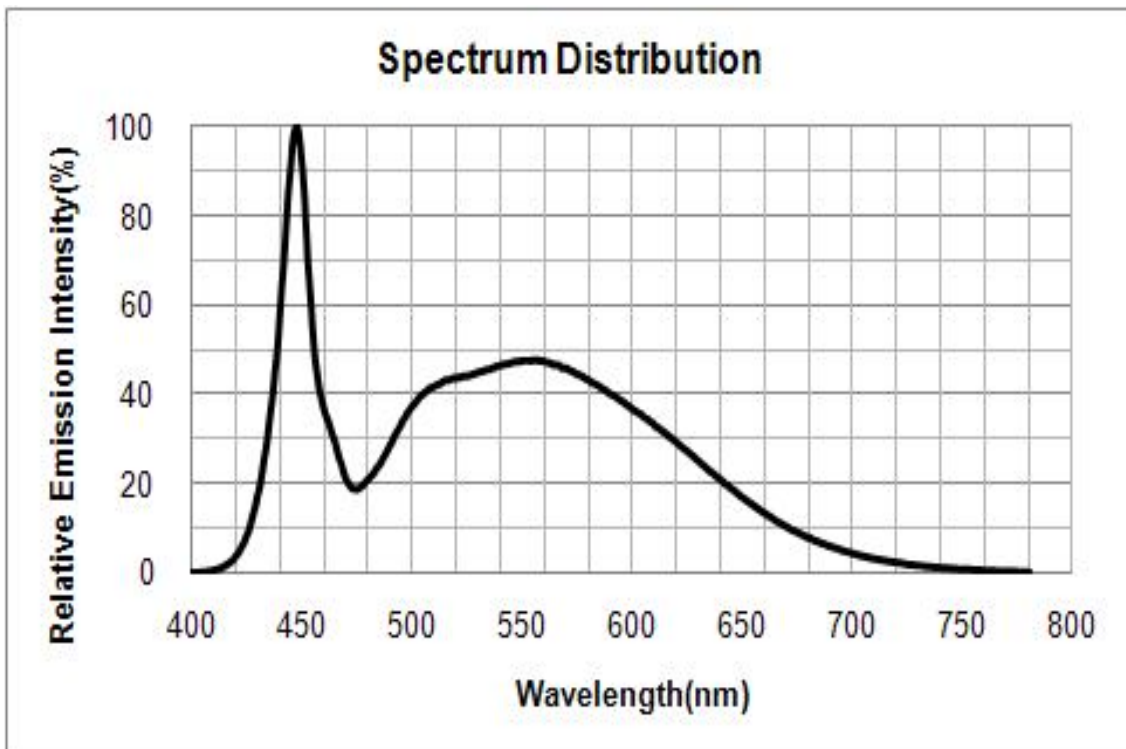

2) Forward Current Characteristics ($T_s = 25^\circ\text{C}$)

(1) Relative Luminous Flux vs. Forward Current

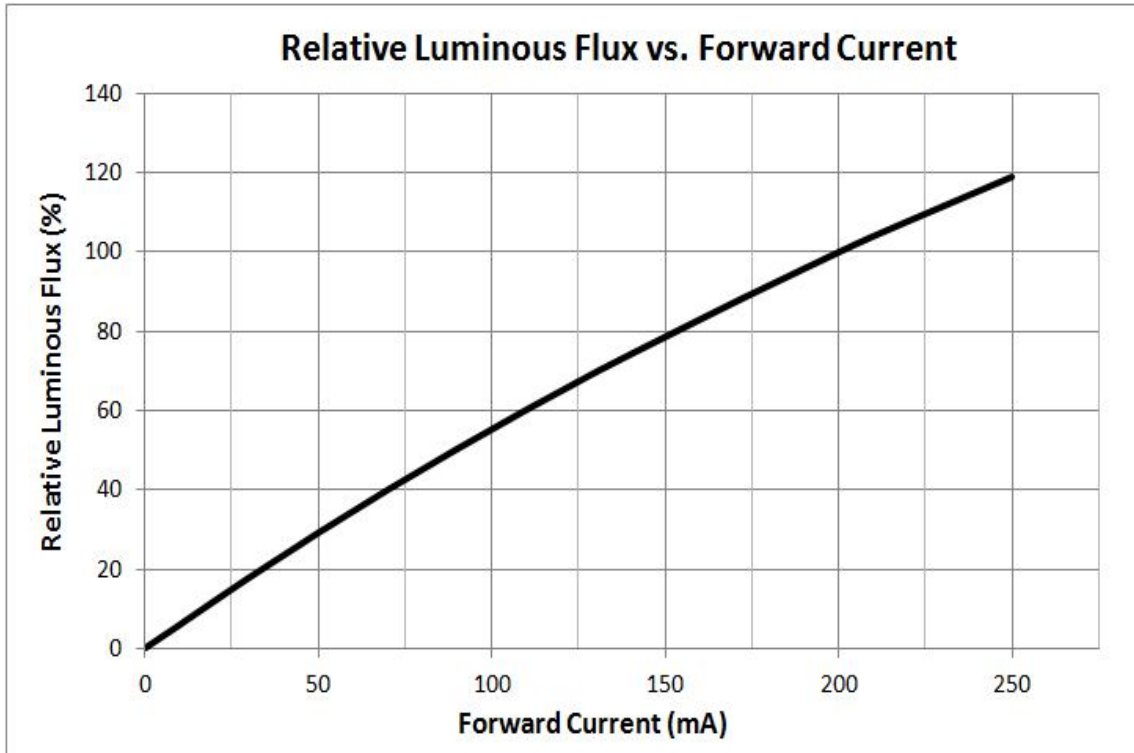

(2) Relative Forward Voltage vs. Forward Current

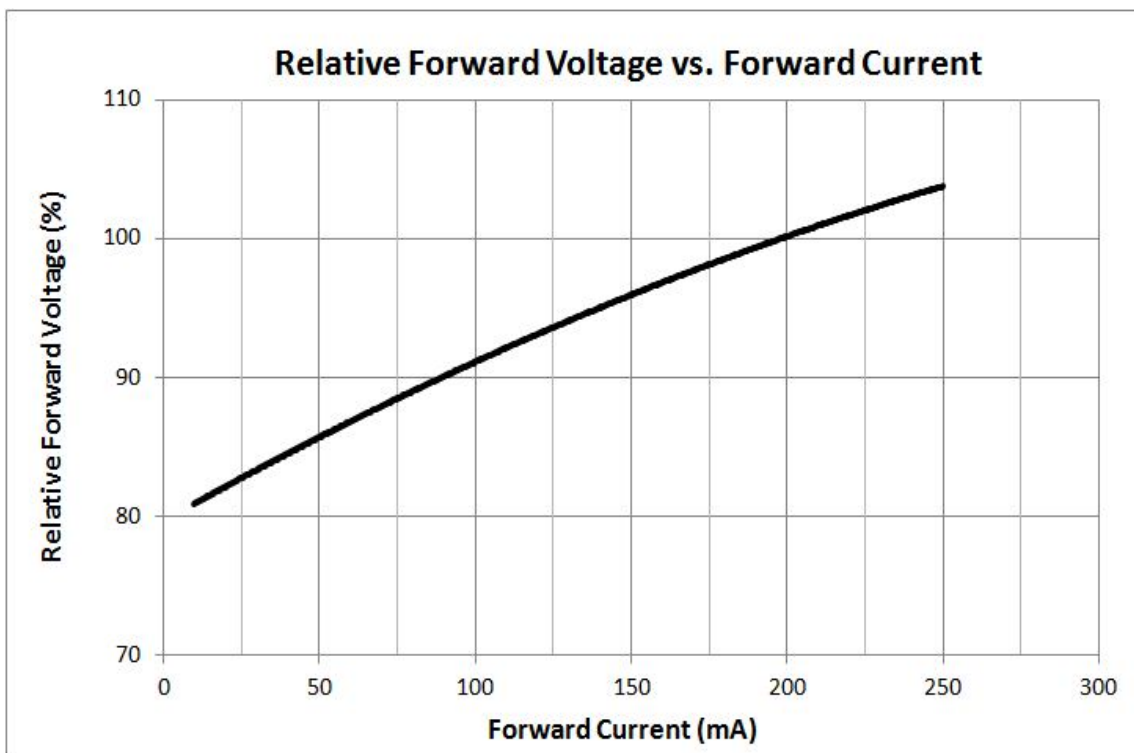

(3) Δ CIE X & Δ CIE Y vs. Forward Current

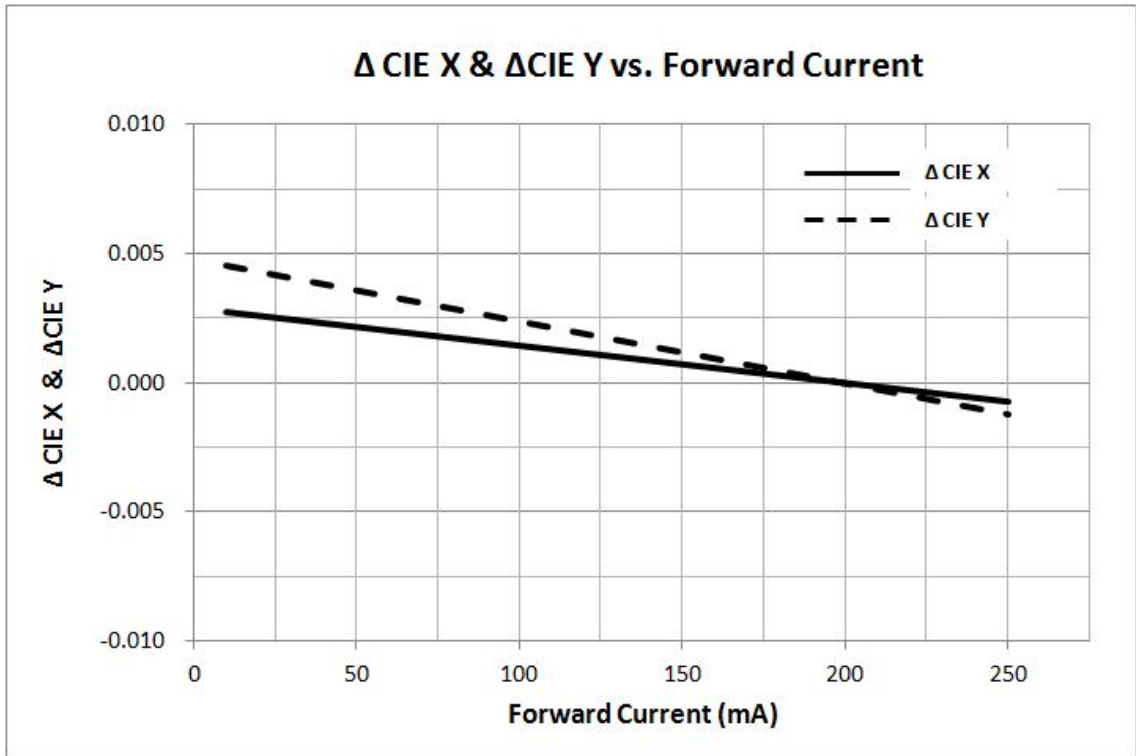

3) Temperature Characteristics (@200mA)

(1) Relative Luminous Flux vs. T_s

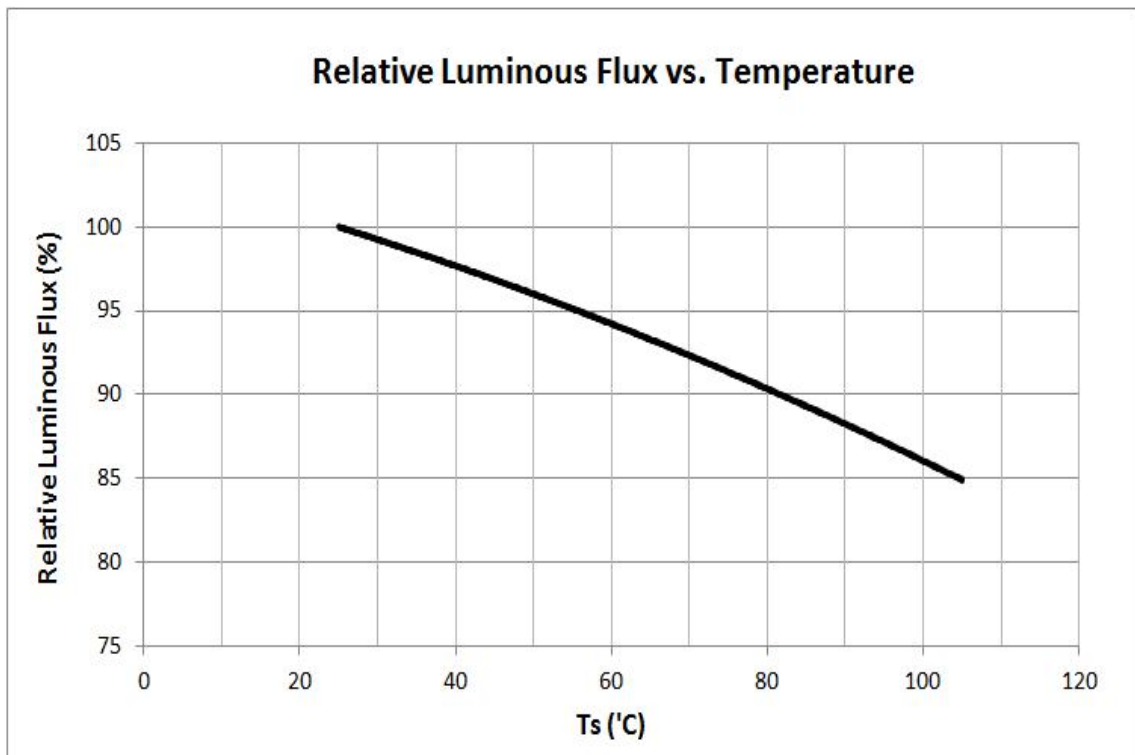

(2) Relative Forward Voltage vs. T_s

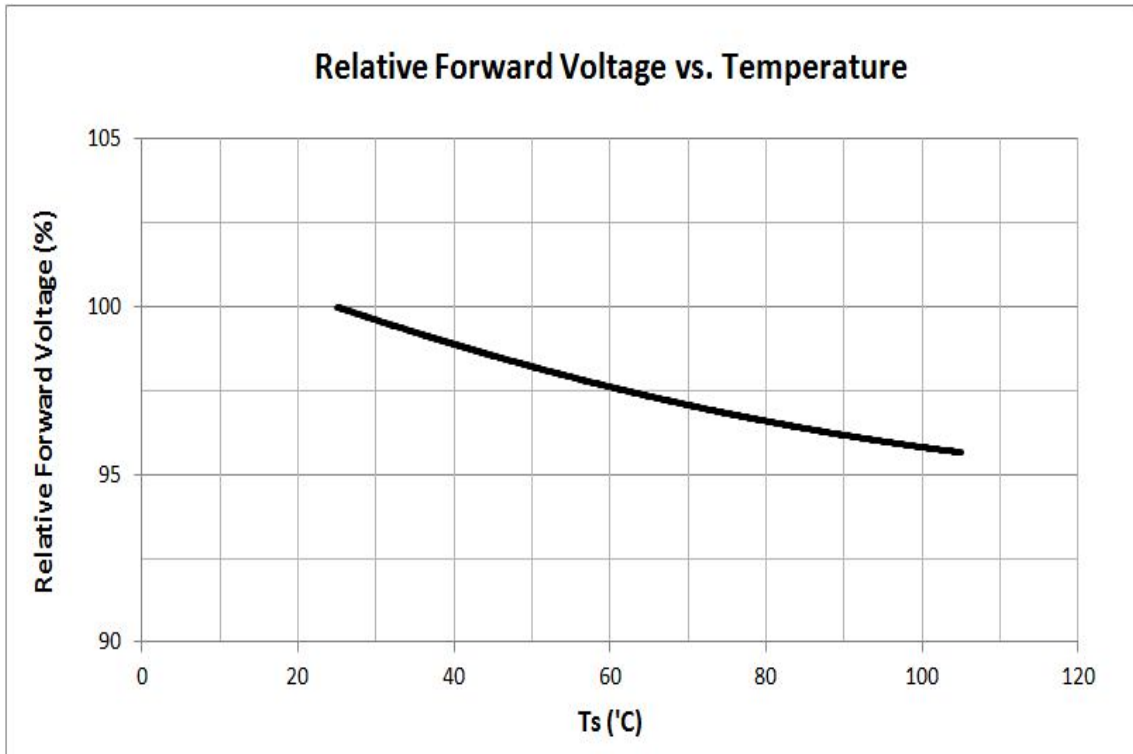

(3) $\Delta CIE X$ & $\Delta CIE Y$ vs. T_s

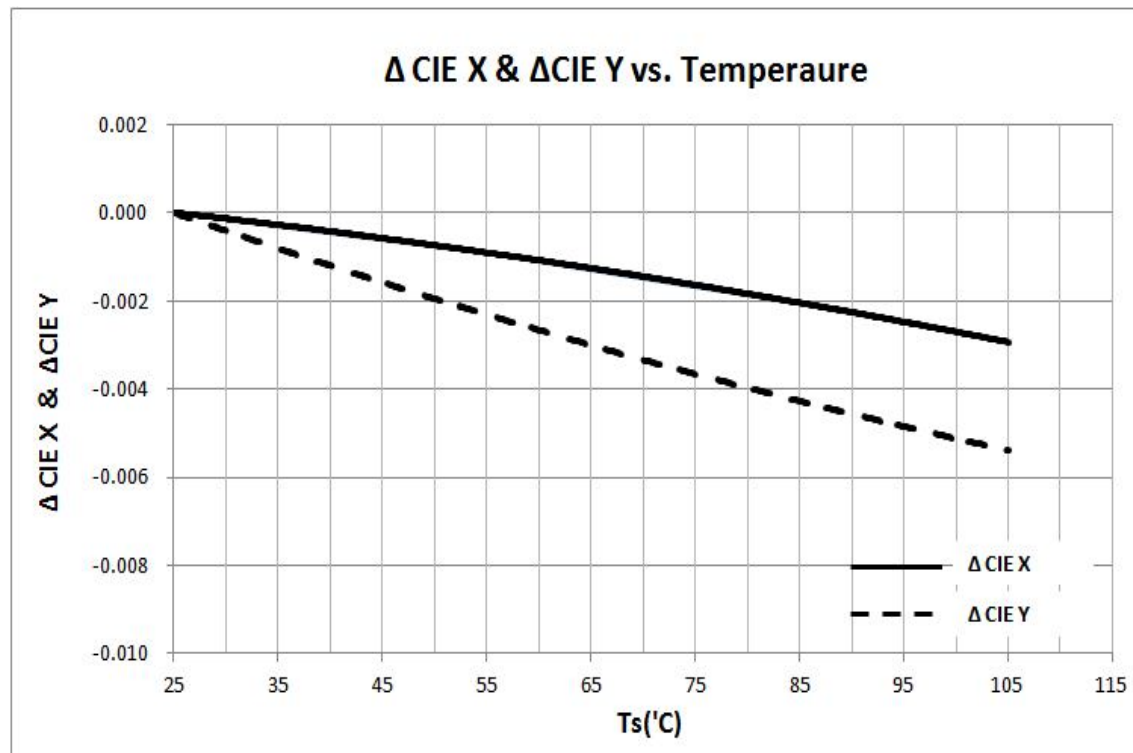

4) Derating Curve

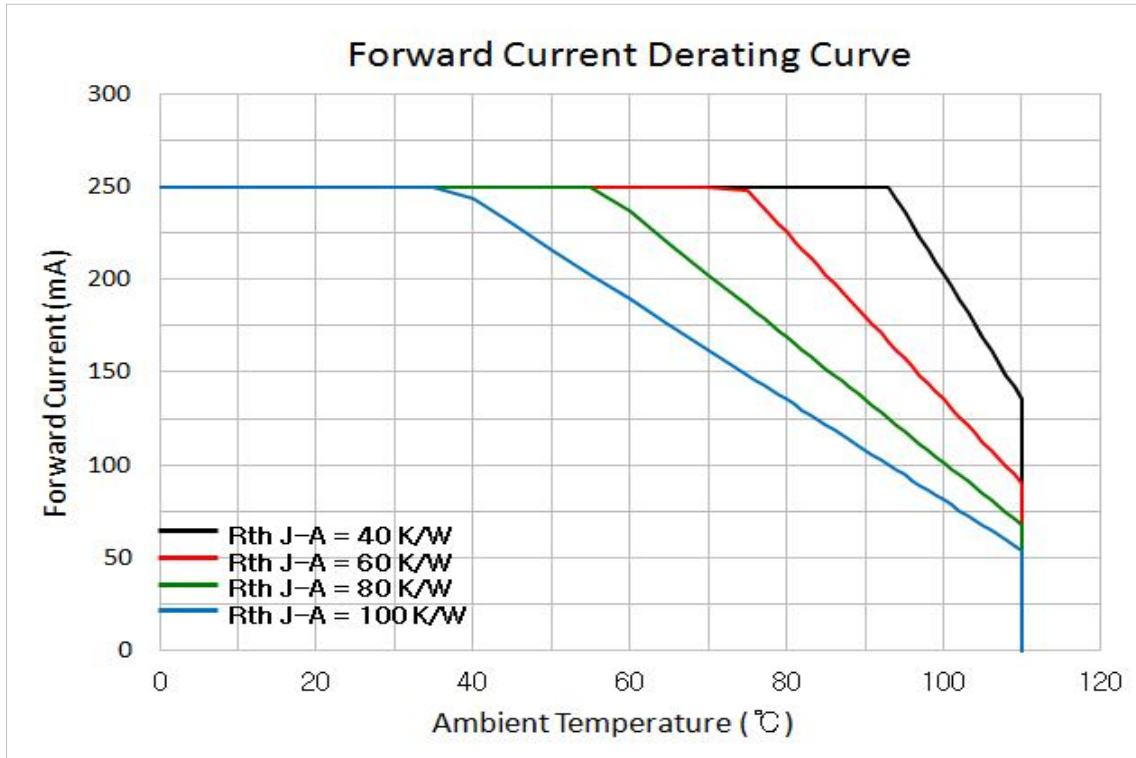

5) Beam Angle Characteristics (@200mA, T_s = 25°C)

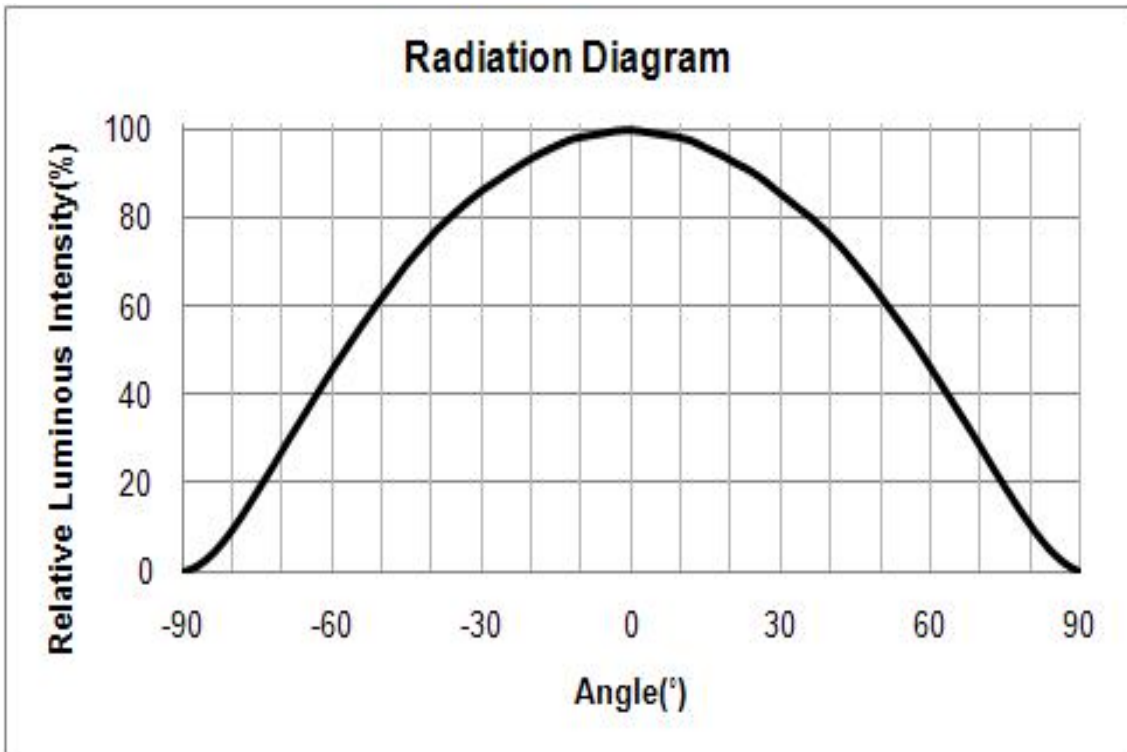

4. Outline Drawing & Dimension

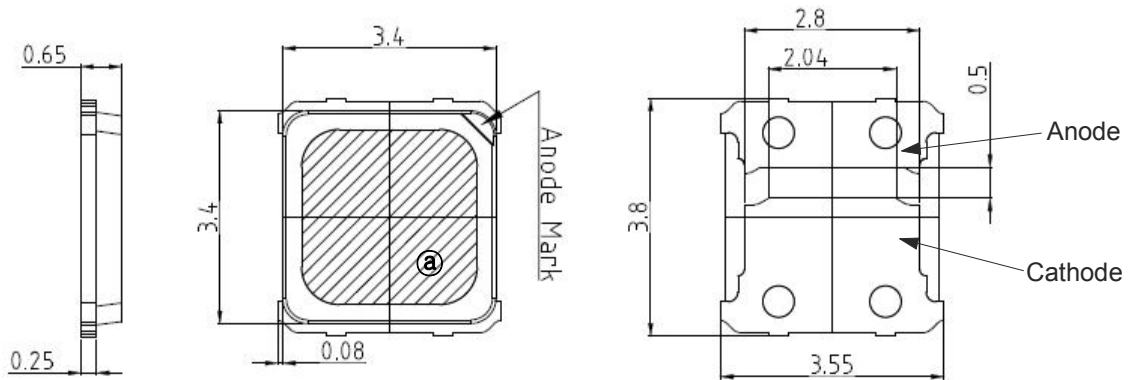

1. Tolerance is ± 0.1 mm
2. Do not place pressure on the encapsulation resin @

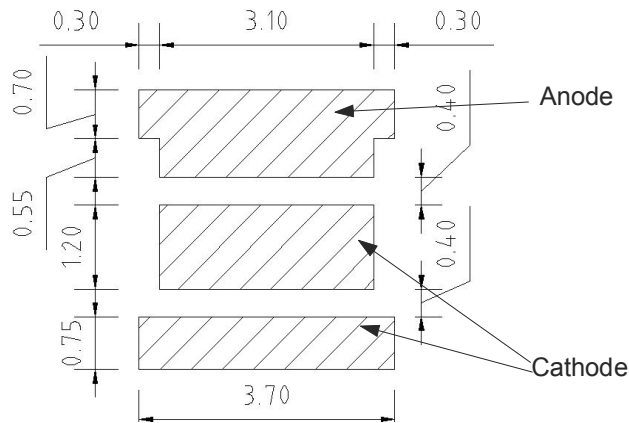

Recommended Land Pattern

Notes:

- 1) This LED has built-in ESD protection device(s) connected in parallel to LED Chip(s).
- 2) Ts point & measurement method
 - ① Measure the nearest point to the thermal pad. If necessary, remove PSR of PCB to reach Ts point.
 - ② Thermal pad must be soldered to the PCB to dissipate heat properly. Otherwise, LED can be damaged.
- 3) Precautions
 - ① The pressure on the LEDs will influence to the reliability of the LEDs. Precautions should be taken to avoid the strong pressure on the LEDs. Do not put stress on the LEDs during heating.
 - ② Re-soldering should not be done after the LEDs have been soldered. If re-soldering is unavoidable, LED's characteristics should be carefully checked before and after such repair.
 - ③ Do not stack assembled PCBs together. Since materials of LEDs is soft, abrasion between two PCB assembled with LED might cause catastrophic failure of the LEDs.

5. Reliability Test Items & Conditions

1) Test Items and Results

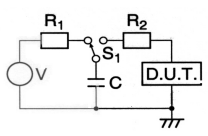
Test Item	Test Conditions	Test Hours/Cycles	Sample Size	
Room Temperature Life Test	25°C±3°C, DC 250mA	1,000 hrs	22	
High Temperature Life Test	85°C±3°C, DC 250mA	1,000 hrs	22	
High Temperature Humidity Life Test	85°C±3°C, 85%±2%RH, DC 250mA	1,000 hrs	22	
Low Temperature Life Test	-40°C±3°C, DC 250mA	1,000 hrs	22	
Powered Temperature Cycle Test	-45°C/20min ↔ 85°C/20min, Sweep 100min cycle on/off: each 5min, DC 250mA	100 cycles	22	
Thermal Shock	-45°C/15min ↔ 125°C/15min, → Hot plate 180°C	500 cycles	100	
High Temperature Storage	Ta=120°C±3°C	1,000 hrs	11	
Low Temperature Storage	Ta=-40°C±3°C	1,000 hrs	11	
ESD(HBM)		R1 : 10MΩ, R2 : 1.5KΩ, C : 100pF, V = ±5kV	5 times	30
ESD(MM)		R1 : 10MΩ, R2 : 0, C : 200pF, V = ±0.5kV	5 times	30
Vibration Test	20~2000~20 Hz 200 m/s ² , Sweep 4 min X, Y, Z 3 direction, each 1 cycle	4 cycles	11	
Mechanical Shock Test	1500G, 0.5ms, 3 shocks each X-Y-Z axis	5 cycles	11	

2) Criteria for Judging the Damage

Item	Symbol	Test Condition	Limit	
			Min	Max
Forward Voltage	V _F	I _F = 200 mA	Init. Value*0.9	Init. Value*1.1
Luminous Flux	Φ _v	I _F = 200 mA	Init. Value*0.7	Init. Value*1.1

6. Solder Conditions

1) Reflow Conditions (Pb Free)

Reflow Frequency : 2 times max.

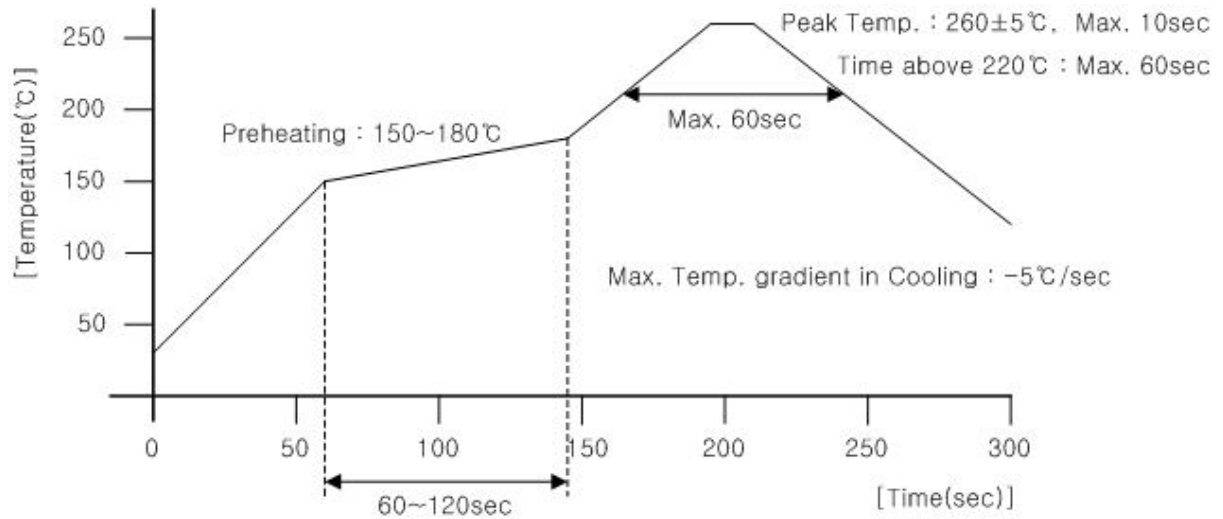

2) For Manual Soldering

Not more than 5 seconds @Max. 300°C, under soldering iron.

7. Tape & Reel

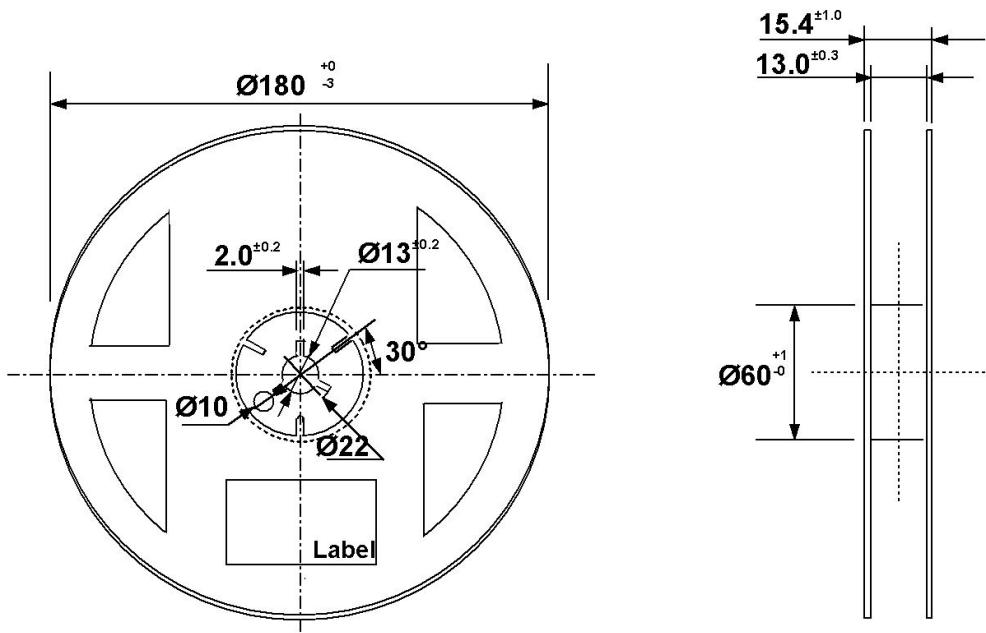
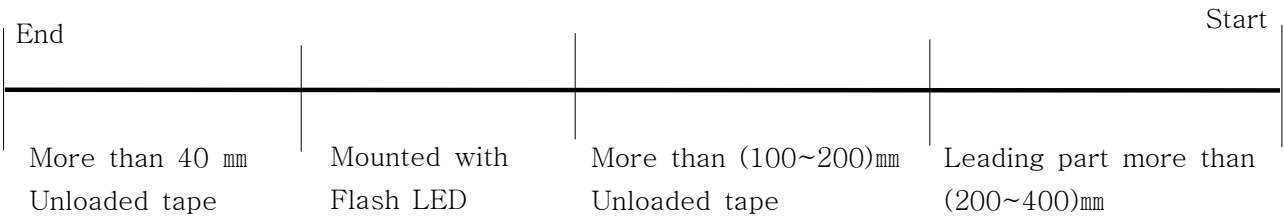
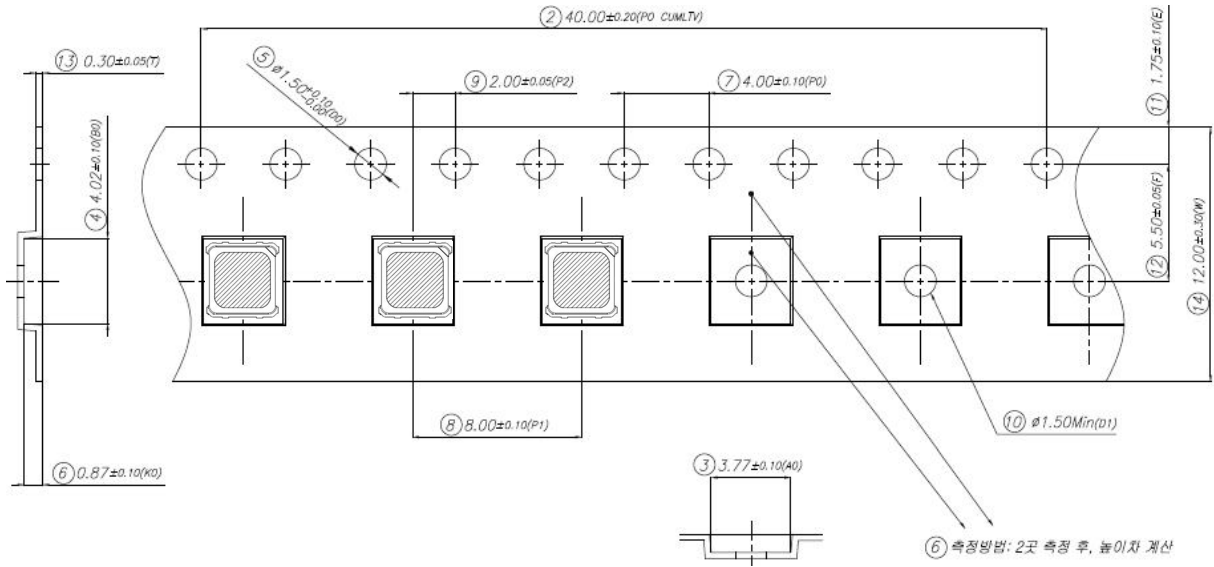

Tolerance ± 0.2 , Unit:mm

- (1) Quantity : The quantity/reel to be 2,000 pcs.
- (2) Cumulative Tolerance : Cumulative tolerance/10 pitches to be ± 0.2 mm
- (3) Adhesion Strength of Cover Tape : Adhesion strength to be 0.1-0.7 N when the cover tape is turned off from the carrier tape at 10 °C angle to be the carrier tape.
- (4) Packaging : P/N, Manufacturing data code no. and quantity to be indicated on a damp proof package.

8. Label Structure

1) Label Structure

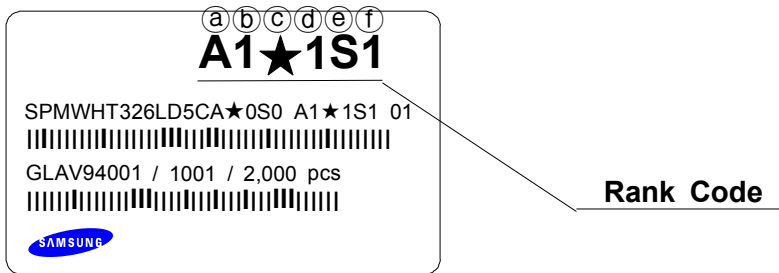

N.B) Denoted rank is the only example.

'★' means All kind of Chromaticity Coordinate Rank.

Rank Code

- ⒶⒷ : Forward Voltage(V_F) Rank (refer to page. 12)
- ⒸⒹ : Chromaticity Coordinate Rank (refer to page. 7~9)
- ⒺⒻ : Luminous Intensity(cd) Rank (refer to page. 3 and 4)

2) LOT Number

The Lot number is composed of the following characters

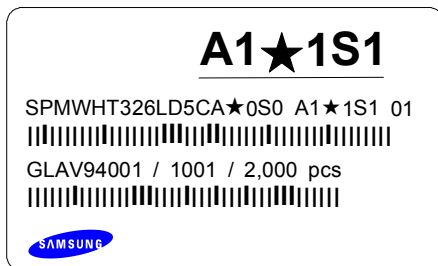

①②③④⑤⑥⑦⑧⑨ / 1ⒶⒷⒸ / 2,000 PCS

- ① : Production Site (S:SAMSUNG ELECTRONICS, G:TIANJIN SAMSUNG ELECTRONICS)
- ② : L (LED)
- ③ : Product State (A:Normality, B:Bulk, C:First Production, R:Reproduction, S:Sample)
- ④ : Year (Y:2014, Z:2015...)
- ⑤ : Month (1 ~ 9, A, B)
- ⑥ : Day (1 ~ 9, A, B ~ V)
- ⑦⑧⑨ : SAMSUNG ELECTRONICS LED Product number (1 ~ 999)
- ⒶⒷⒸ : Reel Number (1 ~ 999)



9. Packing Structure

1) Packing Process

Reel

A1★1S1
 SPMWHT326LD5CA★0S0 A1★1S1 01
 GLAV94001 / 1001 / 2,000 pcs

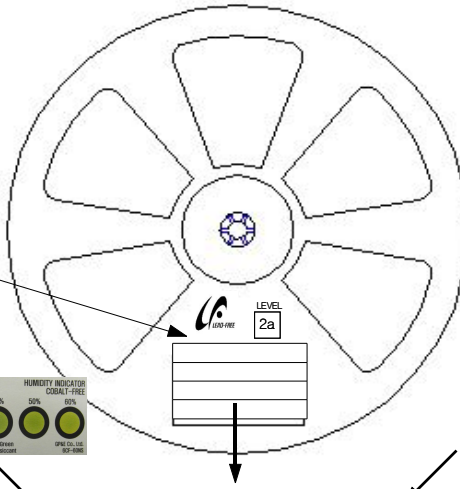

Aluminum Vinyl Bag

A1★1S1
 SPMWHT326LD5CA★0S0 A1★1S1 01
 GLAV94001 / 1001 / 2,000 pcs

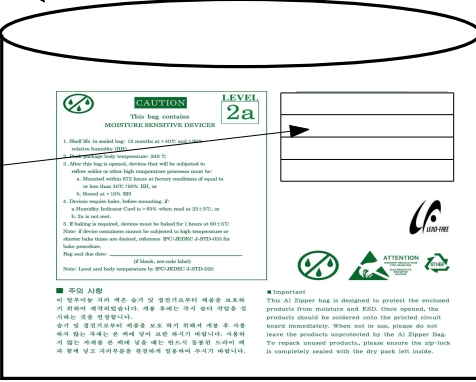

Material : Paper(SW3B(B))

TYPE	SIZE(mm)		
	L	W	H
7inch L	245±5	220±5	182±5
7inch S	245±5	220±5	86±5

① SIDE

A1★1S1
 SPMWHT326LD5CA★0S0 A1★1S1 01
 GLAV94001 / 1001 / 20,000 pcs

[Box Label]

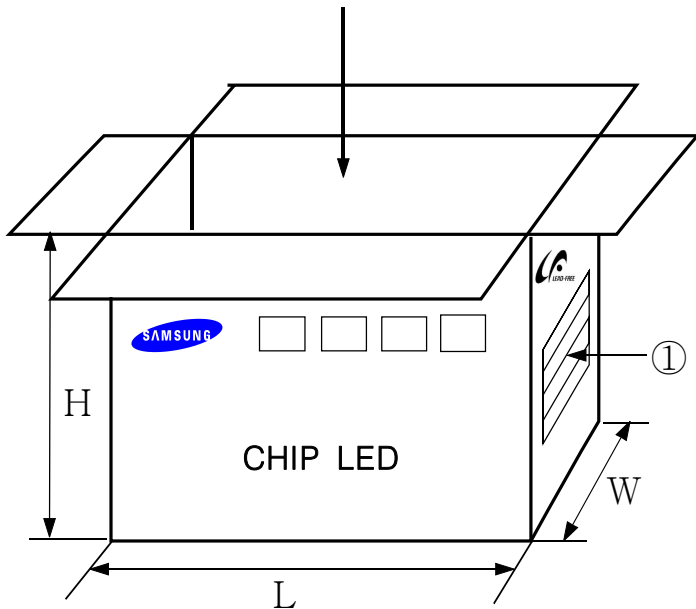

Notes:

7inch L Box : Up to 10 Reels

7inch S Box : Up to 5 Reels

<http://www.samsungled.com>

2) Aluminum Packing Bag

CAUTION

This bag contains
MOISTURE SENSITIVE DEVICES

LEVEL

2a

1. Shelf life in sealed bag: 12 months at <math>< 40^{\circ}\text{C}</math> and <math>< 90\%</math> relative humidity (RH)
2. Peak package body temperature: 240 °C
3. After this bag is opened, devices that will be subjected to reflow solder or other high temperature processes must be:
 - a. Mounted within 672 hours at factory conditions of equal to or less than 30°C / 60% RH, or
 - b. Stored at <math>< 10\%</math> RH
4. Devices require bake, before mounting, if:
 - a. Humidity Indicator Card is > 65% when read at 23±5°C, or
 - b. 2a is not met.
5. If baking is required, devices must be baked for 1 hours at 60±5°C

Note: if device containers cannot be subjected to high temperature or shorter bake times are desired, reference IPC/JEDEC J-STD-033 for bake procedure,

Bag seal due date: _____
(if blank, see code label)

Note: Level and body temperature by IPC/JEDEC J-STD-020

A1★1S1

SPMWHT326LD5CA★0S0 A1★1S1 01

|||||

GLAV94001 / 1001 / 2,000 pcs

|||||

ATTENTION

OBSEVE PRECAUTIONS
FOR HANDLING

ELECTROSTATIC
SENSITIVE
DEVICES

주의 사항

이 알루미늄 지퍼 백은 습기 및 정전기로부터 제품을 보호하기 위하여 제작되었습니다. 개봉 후에는 즉시 솔더 작업을 실시하는 것을 권장합니다.

습기 및 정전기로부터 제품을 보호 하기 위해서 개봉 후 사용하지 않는 자재는 본 팩에 넣어 보관 하시기 바랍니다. 사용하지 않는 자재를 본 팩에 넣을 때는 반드시 동봉된 드라이 팩과 함께 넣고 지퍼부분을 완전하게 밀봉하여 주시기 바랍니다.

Important

This Al Zipper bag is designed to protect the enclosed products from moisture and ESD. Once opened, the products should be soldered onto the printed circuit board immediately. When not in use, please do not leave the products unprotected by the Al Zipper Bag. To repack unused products., please ensure the zip-lock is completely sealed with the dry pack left inside.

Silica gel & Humidity Indicator Card in Aluminum Vinyl Bag

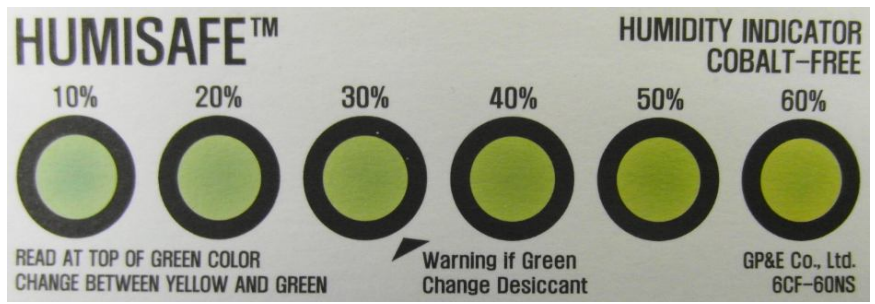

10. Precaution for use

- 1) For over-current-proof function, customers are recommended to apply resistors to prevent sudden change of the current caused by slight shift of the voltage.

과전류 방지를 위해 전압의 미세한 이동에 의해 야기되는 전류의 순간 변화를 방지하기 위해 저항 등의 설치를 권장함.

- 2) This device should not be used in any type of fluid such as water, oil, organic solvent, etc. When washing is required, IPA is recommended to use.

제품은 물, 오일, 유기물과 같은 액체 타입에서의 사용은 제한되며, 세정이 필요할 시에는 IPA 사용을 권장함.

- 3) When the LEDs illuminate, operating current should be decided after considering the ambient maximum temperature.

LED의 발광 시, 동작 전류는 주변 최고온도를 고려하여 결정되어야 함.

- 4) LEDs must be stored in a clean environment.

If the LEDs are to be stored for 3 months or more after being shipped from Samsung Electronics, they should be packed by a sealed container with nitrogen gas injected.(Shelf life of sealed bags: 12 months, temp. ~40°C, ~90%RH)

LED의 보관은 청정한 환경에서 보존되어야 하며, 만약 삼성전자로부터 공급받는 후 3개월 또는 그 이상 보관이 필요하다면 질소 가스를 동봉한 보존용기에 보관되어야 함. (보존 bag의 수명 : 12 개월, 보존 온도 ~40°C, 습도 ~90%RH)

- 5) After storage bag is open, device subjected to soldering, solder reflow, or other high temperature processes must be:

보존 Bag이 개봉된 후에, 납땀이나 reflow등의 높은 온도에 노출되는 제품은 다음의 사항에 부합되어야 함.

- a. Mounted within 672 hours(28 days) at an assembly line with a condition of no more than 30°C/60%RH,

a. 제품은 30°C/60%RH보다 같거나 낮은 조립조건에서 672시간(28일)이내에 조립해야 함.

- b. Stored at <10%RH.

b. 10% 이하의 상대습도에서 보관되어야 함.

- 6) Repack unused Products with anti-moisture packing, fold to close any opening and then store in a dry place.

사용하지 않은 제품은 방습팩에 넣어 개봉 부위를 닫아서 다시 포장한 후, 건조한 장소에서 보관할 것을 권장함.

7) Devices require baking before mounting, if humidity card reading is $>60\%$ at $23\pm 5^{\circ}\text{C}$.
만약 습도표시카드의 수치가 $23\pm 5^{\circ}\text{C}$ 에서 60% 이상이라면, 제품 실장 전 baking해야 함.

8) Devices must be baked for 1 hour at $65\pm 5^{\circ}\text{C}$, if baking is required.
만약 baking이 필요하다면, 제품은 $65\pm 5^{\circ}\text{C}$ 에서 1시간 정도 baking 되어야 함.

9) The LEDs are sensitive to the static electricity and surge. It is recommended to use a wrist band or anti-electrostatic glove when handling the LEDs.

LED는 정전기 및 서지에 민감한 제품이므로, LED 제품을 다룰 시에는 정전기 방지장갑이나 손목밴드를 사용하기를 권장함.

If voltage exceeding the absolute maximum rating is applied to LEDs, it may cause damage or even destruction to LED devices.

만약 절대 허용치를 초과하는 전압이 LED에 가해지면, LED 소자는 파괴되거나 손상될 수 있음.

Damaged LEDs may show some unusual characteristics such as increase in leak current, lowered turn-on voltage, or abnormal lighting of LEDs at low current.

손상된 제품은 누설전류의 증가, Turn on 전압의 저하, 저 전류에서의 점등불량 등의 이상 거동을 보일 수 있음.

10) VOCs (volatile organic compounds) can be generated from adhesives, flux, hardener or organic additives used in luminaires (fixtures). Transparent LED silicone encapsulant is permeable to those chemicals and they may lead a discoloration of encapsulant when they expose to heat or light.

VOCs(휘발성 유기 화합물)는 등기구에 사용되는 접착제, Flux, 경화제, 유기물 첨가제에서 발생하여 LED 실리콘 봉지체를 투과하고, 빛 또는 열에 노출되었을 때 변색이 발생 할 수 있음.

This phenomenon can cause a significant loss of light emitted(output) from the luminaires(fixture).

이러한 현상은 등기구로부터 나오는 빛의 중대한 손실을 줄 수 있음.

In order to prevent these problems, we recommend you to know the physical properties of materials used in luminaires, They must be selected carefully.

이러한 문제 발생 방지를 위해서, 등기구에 사용되는 자재에 대한 물성을 알고 주의하여 선택 되어야함.

11) Risk of Sulfurization (or Tarnishing)

The LED from Samsung Electronics uses a silver-plated lead frame and its surface color may change to black(or dark colored) when it is exposed to sulfur (S), chlorine (Cl) or other halogen compound

삼성전자의 LED는 Ag(은)을 도금한 리드프레임을 사용함. 이 리드프레임의 표면이 황(S), 염소(Cl), 또는 다른 할로겐 화합물들에 노출시 Ag(은)은 검정(또는 어두운색)으로 바뀔 수 있음.

Sulfurization of the lead frame may cause intensity degradation, change of chromaticity coordinates and, in extreme cases. open circuit. It requires caution.

리드 프레임의 황화(Sulfurization)는 광량 저하, 색좌표 변화 및 심한 경우 회로내의 LED 무등(Open) 불량을 일으킬 수도 있으니 주의가 필요함.

Due to possible sulfurization of lead frame, LED should not be used and stored together with oxidizing substances made of materials in a following list,

: Rubber, Plain paper, lead solder cream and so on.

리드 프레임 황화(Sulfurization)의 근원이 될 수 있으니 LED는 아래의 목록으로 만들어진 산화성 물질들과 함께 저장, 사용이 불가함 : 고무, 일반 종이, 납땜 크림 등



11. Hazard Substance Analysis

1) RoHS & Halogen Report



Test Report No. F690101/LF-CTSAYAA13-52931

Issued Date: 2013. 11. 27 Page 1 of 6

To: **SAMSUNG ELECTRONICS CO., LTD.**
San #24,Nongseo-dong
Giheung-gu
Yongin-si
Gyeonggi-do
Korea

The following merchandise was submitted and identified by the client as :

SGS File No.	: AYAA13-52931
Product Name	: 3535 White PKG
Item No./Part No.	: N/A
Received Date	: 2013. 11. 20
Test Period	: 2013. 11. 21 to 2013. 11. 27
Test Results	: For further details, please refer to following page(s)
Test Performed	: SGS Korea tested the sample(s) selected by applicant with following results.
Job Comments	: By the applicant's specific request, the sampling and testing was performed only for the part indicated in the photo without disassembly.

Timothy Jeon
Jinhee Kim
Cindy Park
Jerry Jung/ Testing Person

SGS Korea Co., Ltd.

Jeff Jang / Chemical Lab Mgr

This document is issued by the Company subject to its General Conditions of Service printed material available on request or accessible at http://www.sgs.com/sgsweb/Conditions_of_Service.pdf, for analytical based documents subject to Terms and Conditions for Analytical Documents at http://www.sgs.com/sgsweb/Analytical_Documents.pdf. Attention is drawn to the limitation of liability, indemnification and jurisdiction issues defined therein. Any holder of this document is advised that information contained therein reflects the Company's findings at the time of its intervention only and within the limits of Client's instructions. If any. The Company and its subsidiaries do not assume liability for a transaction from exercising all their rights and obligations under the Transaction Document. This document cannot be reproduced, stored in a retrieval system or transmitted in any form or by any means, electronic, mechanical, photocopying, recording, or by any information storage and retrieval system, without prior written approval of the Company. Any unauthorized alteration, forgery or falsification of the content or appearance of this document is strictly prohibited and may be prosecuted in the fullest extent of the law. Unless otherwise stated the results shown in this test report refer only to the sample(s) tested and each sample(s) is not related to 20 days only.

FD52 Version5

SGS Korea Co., Ltd.

322, The O valley, 555-8, Hoggae-dong, Dongan-gu, Anyang-si, Gyeonggi-do, Korea 431-080
T +82 (0)31 4508 000 F +82 (0)31 4508 059 <http://www.spslab.co.kr> www.kr.sgs.com/sgsweb/lab

Member of the SGS Group (Société Générale de Surveillance)

Test Report No. F690101/LF-CTSAYAA13-52931

Issued Date: 2013. 11. 27 Page 2 of 6

Sample No. : AYAA13-52931.001
 Sample Description : 3535 White PKG
 Item No./Part No. : N/A
 Materials : N/A

Heavy Metals

Test Items	Unit	Test Method	MDL	Results
Cadmium (Cd)	mg/kg	With reference to IEC 62321:2013, ICP	0.5	N.D.
Lead (Pb)	mg/kg	With reference to IEC 62321:2013, ICP	5	N.D.
Mercury (Hg)	mg/kg	With reference to IEC 62321:2013, ICP	2	N.D.
Hexavalent Chromium (Cr VI)	mg/kg	With reference to IEC 62321:2008, UV-VIS	1	N.D.

Flame Retardants-PBBs/PBDEs

Test Items	Unit	Test Method	MDL	Results
Monobromobiphenyl	mg/kg	With reference to IEC 62321:2008, GC-MS	5	N.D.
Dibromobiphenyl	mg/kg	With reference to IEC 62321:2008, GC-MS	5	N.D.
Tribromobiphenyl	mg/kg	With reference to IEC 62321:2008, GC-MS	5	N.D.
Tetrabromobiphenyl	mg/kg	With reference to IEC 62321:2008, GC-MS	5	N.D.
Pentabromobiphenyl	mg/kg	With reference to IEC 62321:2008, GC-MS	5	N.D.
Hexabromobiphenyl	mg/kg	With reference to IEC 62321:2008, GC-MS	5	N.D.
Heptabromobiphenyl	mg/kg	With reference to IEC 62321:2008, GC-MS	5	N.D.
Octabromobiphenyl	mg/kg	With reference to IEC 62321:2008, GC-MS	5	N.D.
Nonabromobiphenyl	mg/kg	With reference to IEC 62321:2008, GC-MS	5	N.D.
Decabromobiphenyl	mg/kg	With reference to IEC 62321:2008, GC-MS	5	N.D.
Monobromodiphenyl ether	mg/kg	With reference to IEC 62321:2008, GC-MS	5	N.D.
Dibromodiphenyl ether	mg/kg	With reference to IEC 62321:2008, GC-MS	5	N.D.
Tribromodiphenyl ether	mg/kg	With reference to IEC 62321:2008, GC-MS	5	N.D.
Tetrabromodiphenyl ether	mg/kg	With reference to IEC 62321:2008, GC-MS	5	N.D.
Pentabromodiphenyl ether	mg/kg	With reference to IEC 62321:2008, GC-MS	5	N.D.
Hexabromodiphenyl ether	mg/kg	With reference to IEC 62321:2008, GC-MS	5	N.D.
Heptabromodiphenyl ether	mg/kg	With reference to IEC 62321:2008, GC-MS	5	N.D.
Octabromodiphenyl ether	mg/kg	With reference to IEC 62321:2008, GC-MS	5	N.D.
Nonabromodiphenyl ether	mg/kg	With reference to IEC 62321:2008, GC-MS	5	N.D.
Decabromodiphenyl ether	mg/kg	With reference to IEC 62321:2008, GC-MS	5	N.D.

NOTE:

- (1) N.D. = Not detected. (<MDL)
- (2) mg/kg = ppm
- (3) MDL = Method Detection Limit
- (4) - = No regulation
- (5) Negative = Undetectable / Positive = Detectable
- (6) ** = Qualitative analysis (No Unit)
- (7) * = Boiling-water-extraction:
 Negative = Absence of CrVI coating
 Positive = Presence of CrVI coating; the detected concentration in boiling-water-extraction solution is equal or greater than 0.02 mg/kg with 50 cm² sample surface area.

This document is issued by the Company subject to the General Conditions of Service printed, attached, available on request or accessible at <http://www.sgs.com/ServiceConditions.aspx> and to electronic based documents subject to Terms and Conditions for Electronic Documents at <http://www.sgs.com/ServiceConditions.aspx>. Attention is drawn to the limitation of liability, indemnification and arbitration clauses defined therein. Any holder of this document is notified that information contained therein reflects the Company's findings at the time of its intervention only and within the limits of Client's instructions. If any. The Company's sole responsibility is to its Client and this document does not constitute neither a transaction nor exceeding all their rights and obligations under the transaction documents. This document cannot be reproduced except in full, without prior written approval of the Company. Any unauthorized alteration, forgery or falsification of the content or appearance of this document is unlawful and offenders may be prosecuted to the fullest extent of the law. Unless otherwise stated, the results shown in this test report refer only to the samples tested and such representations related to 50 days only.



Test Report No. F690101/LF-CTSAYAA13-52931

Issued Date: 2013. 11. 27 Page 3 of 6

Sample No. : AYAA13-52931.001
Sample Description : 3535 White PKG
Item No./Part No. : N/A
Materials : N/A

Halogen Content

Test Items	Unit	Test Method	MDL	Results
Bromine(Br)	mg/kg	BS EN 14582:2007 , IC	30	N.D.
Chlorine(Cl)	mg/kg	BS EN 14582:2007 , IC	30	N.D.
Fluorine(F)	mg/kg	BS EN 14582:2007 , IC	30	N.D.
Iodine(I)	mg/kg	BS EN 14582:2007 , IC	50	N.D.

Other(s)

Test Items	Unit	Test Method	MDL	Results
PFOS (Perfluorooctane Sulfonates-Acid/Metal Salt/Amide)	mg/kg	US EPA 3540C/3550C, LC/MS	1	N.D.

NOTE:

- (1) N.D. = Not detected.(<MDL)
- (2) mg/kg = ppm
- (3) MDL = Method Detection Limit
- (4) - = No regulation
- (5) Negative = Undetectable / Positive = Detectable
- (6) ** = Qualitative analysis (No Unit)
- (7) * = Boiling-water-extraction:
 Negative = Absence of CrVI coating
 Positive = Presence of CrVI coating; the detected concentration in boiling-water-extraction solution is equal or greater than 0.02 mg/kg with 50 cm2 sample surface area.

The document is issued by the Company subject to its General Conditions of Service printed, posted, available or accessible at <http://www.sgs.com/ServiceConditions.pdf> and to electronic format documents subject to Terms and Conditions for Electronic Documents at http://www.sgs.com/ServiceConditions_electronic.pdf. Attention is drawn to the limitation of liability, indemnification and arbitration clauses defined therein. Any holder of this document is notified that information contained therein reflects the Company's findings at the time of its intervention only and within the limits of Client's instructions. If any. The Company's sole responsibility is to its Client and this document does not constitute neither a transaction nor an extension of their rights and obligations under the transaction documents. This document cannot be reproduced except in full, without prior written approval of the Company. Any unauthorized alteration, forgery or falsification of the content or appearance of this document is unlawful and offenders may be prosecuted to the fullest extent of the law. Unless otherwise stated, the results shown in this test report refer only to the samples tested and such samples are retained for 90 days only.



Test Report No. F690101/LF-CTSAYAA13-52931

Issued Date: 2013. 11. 27 Page 4 of 6



NOTE:

- (1) N.D. = Not detected.(<MDL)
- (2) mg/kg = ppm
- (3) MDL = Method Detection Limit
- (4) - = No regulation
- (5) Negative = Undetectable / Positive = Detectable
- (6) ** = Qualitative analysis (No Unit)
- (7) * = Boiling-water-extraction:
 - Negative = Absence of CrVI coating
 - Positive = Presence of CrVI coating; the detected concentration in boiling-water-extraction solution is equal or greater than 0.02 mg/kg with 50 cm² sample surface area.

The document is issued by the Company subject to its General Conditions of Service printed, available or posted on accessible at <http://www.sgs.com/ServiceConditions.htm> and to electronic format documents subject to Terms and Conditions for Electronic Documents at <http://www.sgs.com/ServiceConditions.htm>. Attention is drawn to the limitation of liability, indemnification and jurisdiction issues defined therein. Any holder of this document is advised that information contained therein reflects the Company's findings at the time of its intervention only and within the limits of Client's instructions. If any. The Company's sole responsibility is to its Client and this document does not constitute advice in a transaction form exceeding all their rights and obligations under the transaction documents. This document cannot be reproduced except in full, without prior written approval of the Company. Any unauthorized alteration, forgery or falsification of the content or appearance of this document is unlawful and offenders may be prosecuted to the fullest extent of the law. Unless otherwise stated the results shown in this test report refer only to the sample(s) tested and such sample(s) are retained for 90 days only.



Test Report No. F690101/LF-CTSAYAA13-52931

Issued Date: 2013. 11. 27 Page 5 of 6

Testing Flow Chart for RoHS:Cd/Pb/Hg/Cr⁶⁺ /PBBs&PBDEs Testing

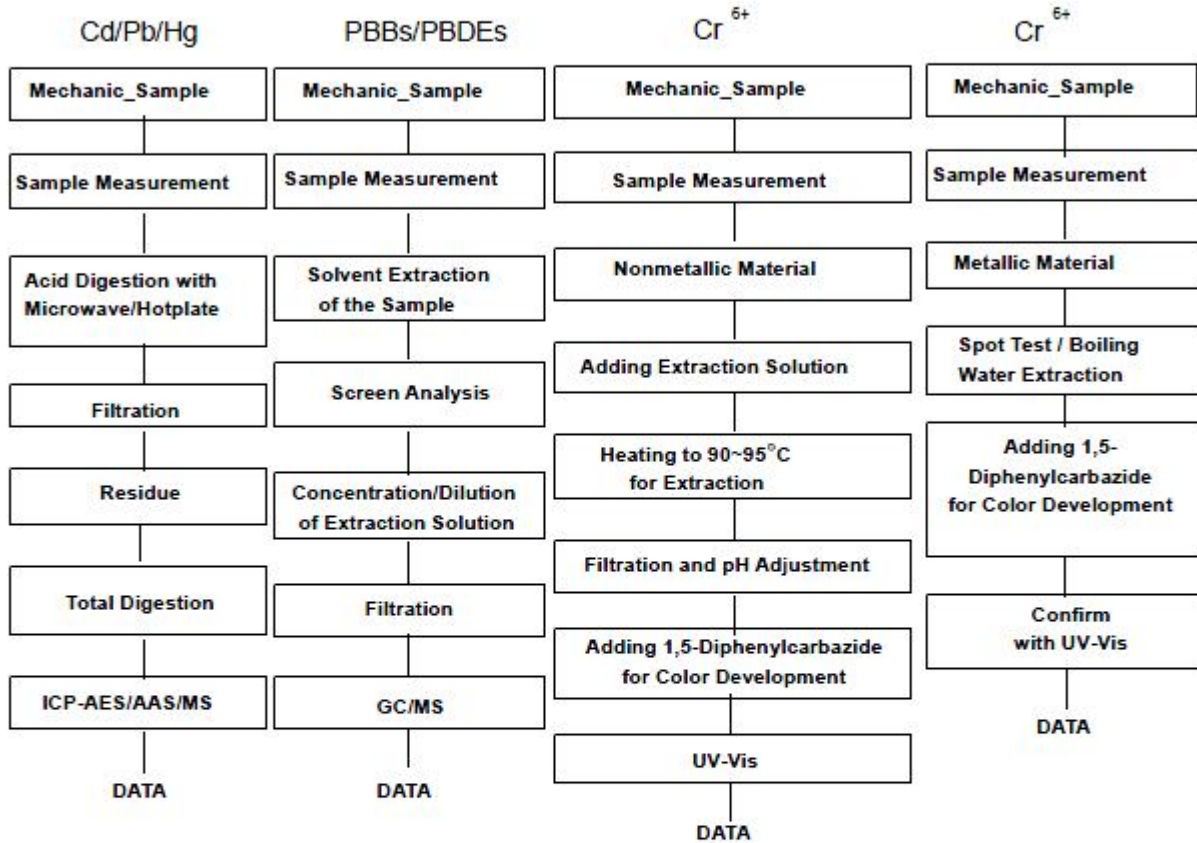

The samples were dissolved totally by pre-conditioning method according to above flow chart for Cd,Pb,Hg.
Section Chief : Gilsae Yi

NOTE:

- (1) N.D. = Not detected.(<MDL)
- (2) mg/kg = ppm
- (3) MDL = Method Detection Limit
- (4) - = No regulation
- (5) Negative = Undetectable / Positive = Detectable
- (6) ** = Qualitative analysis (No Unit)
- (7) * = Boiling-water-extraction:
Negative = Absence of CrVI coating
Positive = Presence of CrVI coating; the detected concentration in boiling-water-extraction solution is equal or greater than 0.02 mg/kg with 50 cm² sample surface area.

The document is issued by the Company subject to its General Conditions of Service printed, available or posted on its website at <http://www.sgs.com/ServiceConditions.aspx> and to electronic format documents subject to Terms and Conditions for Electronic Documents at <http://www.sgs.com/ServiceConditions>. Attention is drawn to the limitation of liability, indemnification and arbitration issues defined therein. Any holder of this document is notified that information contained therein reflects the Company's findings at the time of its intervention only and within the limits of Client's instructions. If any. The Company's sole responsibility is to its Client and this document does not constitute advice in a transaction form exceeding all their rights and obligations under the transaction documents. This document cannot be reproduced except in full without prior written approval of the Company. Any unauthorized alteration, forgery or falsification of the content or appearance of this document is unlawful and offenders may be prosecuted to the fullest extent of the law. Unless otherwise stated, the results shown in this test report refer only to the samples tested and such samples are retained for 90 days only.



Flow Chart for Halogen Test

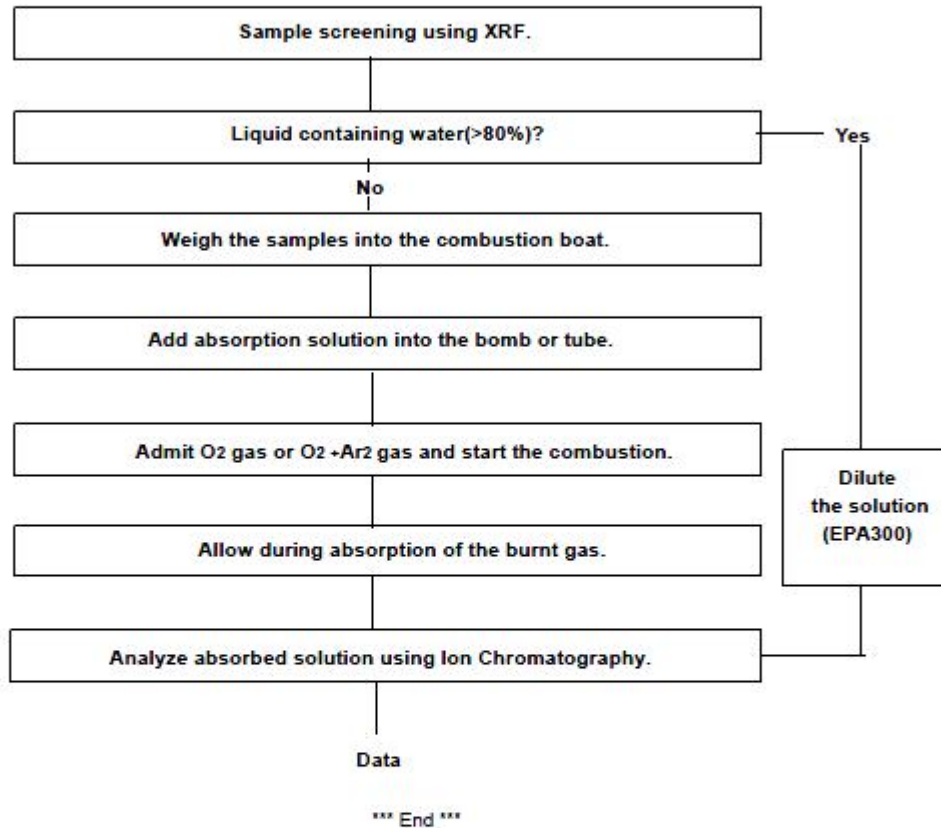

NOTE:

- (1) N.D. = Not detected.(<MDL)
- (2) mg/kg = ppm
- (3) MDL = Method Detection Limit
- (4) - = No regulation
- (5) Negative = Undetectable / Positive = Detectable
- (6) ** = Qualitative analysis (No Unit)
- (7) * = Boiling-water-extraction:
 Negative = Absence of CrVI coating
 Positive = Presence of CrVI coating; the detected concentration in boiling-water-extraction solution is equal or greater than 0.02 mg/kg with 50 cm2 sample surface area.

The document is issued by the Company subject to its General Conditions of Service printed, available or posted on its website at <http://www.sgs.com/ServiceConditions.aspx> and to electronic format documents subject to Terms and Conditions for Electronic Documents at <http://www.sgs.com/ServiceConditions.aspx>. Attention is drawn to the limitation of liability, indemnification and arbitration clauses defined therein. Any holder of this document is advised that information contained therein reflects the Company's findings at the time of its intervention only and within the limits of Client's instructions. If any. The Company's sole responsibility is to its Client and this document does not constitute neither a transaction nor acceptance of their rights and obligations under the transaction documents. This document cannot be reproduced except in full, without prior written approval of the Company. Any unauthorized alteration, forgery or falsification of the content or appearance of this document is unlawful and offenders may be prosecuted to the fullest extent of the law. Unless otherwise stated, the results shown in this test report refer only to the samples tested and such samples are retained for 30 days only.

2) SVHC Report



Test Report No. F690101/LF-CTSAYAA13-52930 Issued Date: 2013. 11. 27 Page 1 of 16

To. **SAMSUNG ELECTRONICS CO., LTD.**
95, Samsung 2-ro
Giheung-gu
Yongin-si
Gyeonggi-do
Korea

The following sample(s) was/were submitted and identified by/on behalf of the client as:-

Product Name	: 3535 White PKG
Item/Part Name	: N/A
SGS File No.	: AYAA13-52930
Received Date	: 2013. 11. 20
Test Period	: 2013. 11. 21 ~ 2013. 11. 27
Test Performed	: SGS Korea tested the sample(s) selected by applicant with following results
Test Requested	: One hundred-forty four (144) substances in the Candidate List of Substances of Very High Concern (SVHC) for authorization published by European Chemicals Agency (ECHA) on June 20, 2013 regarding Regulation (EC) No 1907/2006 concerning the REACH. Seven(7) substances in the Public Consultation List of potential Substances of Very High Concern (SVHC) published by European Chemicals Agency (ECHA) on September 02, 2013 regarding Regulation (EC) No 1907/2006 concerning the REACH.
Test Method	: Please refer to next page(s).
Test Result(s)	: Please refer to next page(s).

Timothy Jeon
Cindy park
Jinhee Kim
Sophia Kim
/Testing Person

SGS Korea Co., Ltd

Jeff Jang / Chemical Lab Mgr

This document is issued by the Company subject to its General Conditions of Service printed hereon, available on request or accessible at <http://www.sgs.com/en/Products-and-Conditions.aspx> and, for electronic format documents, subject to Terms and Conditions for Electronic Documents at www.sgs.com/en/terms-and-conditions.aspx. Client is drawn to the attention of liability, identification and jurisdiction issues defined therein. Any holder of this document is bound by the conditions and obligations contained herein relative to the Company's findings at the time of its observation only and within the limits of Client's responsibilities. If any. The Company's sole responsibility is to its Client and this document does not constitute parties to a transaction from which all their rights and obligations under the transaction documents. This document cannot be reproduced in part or in full without prior written approval of the Company. Any unauthorized alteration, forgery or falsification of the content or appearance of this document is unlawful and offenders may be prosecuted to the fullest extent of the law. Unless otherwise stated the results shown in this test report refer only to the samples tested and each sample is so related to its page only.

F052 Version 5

SGS Korea Co., Ltd.

322, The O valley, 555-9, Hoge-dong, Dongan-gu, Anyang-si, Gyeonggi-do, Korea 431-090
t +82 (0)31 4608 000 f +82 (0)31 4608 059 <http://www.sgslab.co.kr> www.kr.sgs.com/gsemlab

Member of the SGS Group (Société Générale de Surveillance)



Test Report No. F690101/LF-CTSAYAA13-52930 Issued Date: 2013. 11. 27 Page 2 of 16

Test Method:

SGS In-House method - Analyzed by ICP-OES, PLM, UV/VIS, LC/MS, GC/MS and colorimetric method

Remarks:

1. The chemical analysis of specified SVHC is performed by means of currently available analytical techniques against the following SVHC related documents published by ECHA:
<http://echa.europa.eu/web/guest/candidate-list-table> (Candidate list)
http://echa.europa.eu/proposals-to-identify-substances-of-very-high-concern-previous-consultations?p_p_id=substancetypelist_WAR_substanceportlet&p_p_lifecycle=0&p_p_state=normal&p_mode=view&p_p_col_id=column-1&p_p_col_pos=2&p_p_col_count=4&substancetypelis
 (Proposals to identify SVHC consultations)
 This list is under evaluation by ECHA and may subject to change in the future.
2. In accordance with Regulation (EC) No 1907/2006, any producer or importer of articles shall notify ECHA, in accordance with paragraph 2 of Article 7, if a substance meets the criteria in Article 57 and is identified in accordance with Article 59(1) of the Regulation, if (a) the substance is present in those articles in quantities totaling over one tonne per producer or importer per year; and (b) the substance is present in those articles above a concentration of **0.1 %** weight by weight (w/w).
3. Article 33 of Regulation (EC) No 1907/2006 requires supplier of an article containing a substance meeting the criteria in Article 57 and identified in accordance with Article 59(1) in a concentration above **0.1 %** weight by weight (w/w) shall provide the recipient of the article with sufficient information, available to the supplier, to allow safe use of the article including, as a minimum, the name of that substance in the Candidate List.
4. SGS adopts the interpretation of ECHA for SVHC in article unless indicated otherwise. Detail explanation is available at the following link:
http://webstage.contribute.sgs.net/corpreach/documents/SGS-CTS_SVHC-paper-EN-11.pdf
5. Test results in this report are based on the tested sample. This report refers to testing result of composite material group by equal weight proportion. The material in each composite test group may come from one article.
6. If a SVHC is found over the reporting limit, client is suggested to identify the component which contains the SVHC and the exact concentration of the SVHC by requesting further quantitative analysis from the laboratory.

This document is issued by the Company subject to its General Conditions of Service printed overleaf, available on request or accessible at <http://www.sgs.com/termsandconditions> and, for electronic format documents, subject to Terms and Conditions for Electronic Documents at <http://www.sgs.com/termsandconditions>. Client's attention is drawn to the limitation of liability, identification and jurisdiction issues defined therein. Any holder in the document is advised that information contained herein reflects the Company's findings at the time of its issuance only and within the limits of its instructions, if any. The Company accepts no responsibility as to its Client and the document does not exonerate parties to a transaction from observing all their rights and obligations under the transaction documents. This document cannot be reproduced except in full, without prior written approval of the Company. Any unauthorized alteration, forgery or falsification of the content or appearance of this document is unlawful and offenders may be prosecuted to the fullest extent of the law. Unless otherwise stated the results shown in this test report refer only to the samples tested and such samples are retained for 90 days only.

F052 Version 5

SGS Korea Co., Ltd.

322, The C valley, 555-9, Hoga-dong, Dongan-gu, Anyang-si, Gyeonggi-do, Korea 431-080
 t +82 (0)31 4608 000 f +82 (0)31 4608 059 <http://www.sgslab.co.kr> www.kr.sgs.com/globalslab

Member of the SGS Group (Société Générale de Surveillance)

Test Result(s)

Substance Name	CAS number	EC number	Concentration (%)	Reporting Limit (%)	Classification
Alkanes, C10-13, chloro (Short Chain Chlorinated Paraffins)	85535-84-8	287-476-5	N.D.	0.05	PBT
Anthracene	120-12-7	204-371-1	N.D.	0.05	PBT
Benzyl butyl phthalate (BBP)	85-68-7	201-622-7	N.D.	0.05	Toxic for Reproduction
Bis(2-ethylhexyl)phthalate (DEHP)	117-81-7	204-211-0	N.D.	0.05	Toxic for Reproduction
Bis(tributyltin)oxide	56-35-9	200-268-0	N.D.	0.05	PBT
Cobalt dichloride*	7646-79-9	231-589-4	N.D.	0.005	Carcinogen Toxic for Reproduction
4,4-Diaminodiphenylmethane	101-77-9	202-974-4	N.D.	0.05	Carcinogen
Diarsenic pentaoxide*	1303-28-2	215-116-9	N.D.	0.005	Carcinogen
Diarsenic trioxide*	1327-53-3	215-481-4	N.D.	0.005	Carcinogen
Dibutyl phthalate (DBP)	84-74-2	201-557-4	N.D.	0.05	Toxic for Reproduction
Hexabromocyclododecane (HBCDD) and all major diastereoisomers identified (α -HBCDD, β -HBCDD, γ -HBCDD)	25637-99-4 3194-55-6 (134237-51-7, 134237-50-6, 134237-52-8)	247-148-4 221-695-9	N.D.	0.05	PBT
Lead hydrogen arsenate*	7784-40-9	232-064-2	N.D.	0.005	Carcinogen Toxic for Reproduction
Sodium dichromate* (Sodium dichromate, dehydrate)	10588-01-9 (7789-12-0)	234-190-3	N.D.	0.005	Carcinogen Mutagen Toxic for Reproduction
5-tert-butyl-2,4,6-trinitro-m-xylene (musk xylene)	81-15-2	201-329-4	N.D.	0.05	vPvB
Triethyl arsenate*	15606-95-8	427-700-2	N.D.	0.005	Carcinogen

This document is issued by the Company subject to its General Conditions of Service printed herein, available on request or accessible at <http://www.sgs.com/en/Terms-and-Conditions.aspx> and, for electronic format documents, subject to Terms and Conditions for Electronic Documents at <http://www.sgs.com/en/e-documents.aspx>. Client's attention is drawn to the limitation of liability, identification and protection issues defined therein. Any holder in the possession of this document is notified that the information contained herein reflects the Company's findings at the time of its issuance only and within the limits of its accreditation, if any. The Company is sole responsible as to its Client and the document does not exonerate parties to a transaction from exercising all their rights and obligations under the transaction documents. This document cannot be reproduced or copied in full, without prior written approval of the Company. Any unauthorized alteration, forgery or falsification of the content or appearance of this document is unlawful and offenders may be prosecuted to the fullest extent of the law. Unless otherwise stated the results shown in the test report refer only to the samples tested and such samples are related to no one else only.

F052 Version 5

SGS Korea Co., Ltd.

322, The O valley, 555-9, Hogya-dong, Dongan-gu, Anyang-si, Gyeonggi-do, Korea 431-080
t +82 (0)31 4608 000 f +82 (0)31 4608 050 <http://www.sgslab.co.kr> www.kr.sgs.com/gaenlab

Member of the SGS Group (Société Générale de Surveillance)

Substance Name	CAS number	EC number	Concentration (%)	Reporting Limit (%)	Classification
Di-isobutyl phthalate(DIBP)	84-69-5	201-553-2	N.D.	0.05	Toxic for Reproduction
2,4-Dinitrotoluene	121-14-2	204-450-0	N.D.	0.05	Carcinogen
Tris(2-chloroethyl) phosphate	115-96-8	204-118-5	N.D.	0.05	Toxic for Reproduction
Anthracene oil	90640-80-5	292-602-7	N.D.	0.05	PBT; vPvB Carcinogen
Anthracene oil, anthracene paste; distn. Lights	91995-17-4	295-278-5	N.D.	0.05	PBT; vPvB Carcinogen Mutagen
Anthracene oil, anthracene paste, anthracene fraction	91995-15-2	295-275-9	N.D.	0.05	PBT; vPvB Carcinogen Mutagen
Anthracene oil, anthracene-low	90640-82-7	292-604-8	N.D.	0.05	PBT; vPvB Carcinogen Mutagen
Anthracene oil, anthracene paste	90640-81-6	292-603-2	N.D.	0.05	PBT; vPvB Carcinogen Mutagen
Coal tar pitch, high temperature	65996-93-2	266-028-2	N.D.	0.05	PBT; vPvB Carcinogen
Lead sulfochromate yellow (C.I. Pigment Yellow 34)*	1344-37-2	215-693-7	N.D.	0.005	Carcinogen Toxic for Reproduction
Lead chromate molybdate sulfate red (C.I. Pigment Red 104)*	12656-85-8	235-759-9	N.D.	0.005	Carcinogen Toxic for Reproduction
Lead chromate*	7758-97-6	231-846-0	N.D.	0.005	Carcinogen Toxic for Reproduction
Acrylamide	79-06-01	201-173-7	N.D.	0.05	Carcinogen Mutagen

This document is issued by the Company subject to its General Conditions of Service printed hereon, available on request or accessible at <http://www.sgs.com/en/Terms-and-Conditions.aspx> and, for electronic format documents, subject to Terms and Conditions for Electronic Documents at <http://www.sgs.com/en/e-documents.aspx>. Client's attention is drawn to the limitation of liability, identification and jurisdiction issue defined therein. Any holder in the document is notified that the information contained herein reflects the Company's findings at the time of its issuance only and within the limits of its instructions, if any. The Company is not responsible as to its Client and the document does not exonerate parties to a transaction from observing all their rights and obligations under the transaction documents. This document cannot be reproduced or copy in full, without prior written approval of the Company. Any unauthorized alteration, forgery or falsification of the content or appearance of this document is unlawful and offenders may be prosecuted to the fullest extent of the law. Unless otherwise stated the results shown in this test report refer only to the samples tested and such samples are related to no page only.

F052 Version 5

SGS Korea Co., Ltd.

322, The C valley, 555-9, Hoggae-dong, Dongan-gu, Anyang-si, Gyeonggi-do, Korea 431-080
t +82 (0)31 4608 000 f +82 (0)31 4608 050 <http://www.sgslab.co.kr> www.kr.sgs.com/gaenlab

Member of the SGS Group (Société Générale de Surveillance)

Substance Name	CAS number	EC number	Concentration (%)	Reporting Limit (%)	Classification
Boric acid*	10043-35-3 11113-50-1	233-139-2 234-343-4	N.A.	0.005	Toxic for Reproduction
Disodium tetraborate, anhydrous*	1330-43-4 12179-04-3 1303-96-4	215-540-4	N.A.	0.005	Toxic for Reproduction
Tetraboron disodium heptaoxide, hydrate*	12267-73-1	235-541-3	N.A.	0.005	Toxic for Reproduction
Trichloroethylene	79-01-6	201-167-4	N.D.	0.05	Carcinogen
Sodium chromate*	7775-11-3	231-889-5	N.D.	0.005	Carcinogen Mutagen Toxic for Reproduction
Ammonium dichromate*	7789-09-5	232-143-1	N.D.	0.005	Carcinogen Mutagen Toxic for Reproduction
Potassium dichromate*	7778-50-9	231-906-6	N.D.	0.005	Carcinogen Mutagen Toxic for Reproduction
Potassium chromate*	7789-00-6	232-140-5	N.D.	0.005	Carcinogen Mutagen

This document is issued by the Company subject to its General Conditions of Service printed overleaf, available on request or accessible at <http://www.sgs.com/en/Terms-and-Conditions.aspx> and, for electronic format documents, subject to Terms and Conditions for Electronic Documents at <http://www.sgs.com/en/e-documentation>. A client's attention is drawn to the limitation of liability, identification and jurisdiction issues defined therein. Any holder in the document is notified that the information contained herein reflects the Company's findings at the time of its issuance only and within the limits of its instructions, if any. The Company is sole responsible as to its Client and the document does not exonerate parties to a transaction from observing all their rights and obligations under the transaction documents. This document cannot be reproduced or copy in full, without prior written approval of the Company. Any unauthorized alteration, forgery or falsification of the content or appearance of this document is unlawful and offenders may be prosecuted to the fullest extent of the law. Unless otherwise stated the results shown in the test report refer only to the samples tested and such samples are related to no page only.

F052 Version 5

SGS Korea Co., Ltd.

322, The C valley, 555-9, Hogye-dong, Dongan-gu, Anyang-si, Gyeonggi-do, Korea 431-080
t +82 (0)31 4608 000 f +82 (0)31 4608 050 <http://www.sgslab.co.kr> www.kr.sgs.com/sgslab

Member of the SGS Group (Société Générale de Surveillance)

Substance Name	CAS number	EC number	Concentration (%)	Reporting Limit (%)	Classification
Cobalt(II) sulphate*	10124-43-3	233-334-2	N.D.	0.005	Carcinogen Toxic for Reproduction
Cobalt(II) dinitrate*	10141-05-6	233-402-1	N.D.	0.005	Carcinogen Toxic for Reproduction
Cobalt(II) carbonate*	513-79-1	208-169-4	N.D.	0.005	Carcinogen Toxic for Reproduction
Cobalt(II) diacetate*	71-48-7	200-755-8	N.D.	0.005	Carcinogen Toxic for Reproduction
2-Methoxyethanol	109-86-4	203-713-7	N.D.	0.05	Toxic for Reproduction
2-Ethoxyethanol	110-80-5	203-804-1	N.D.	0.05	Toxic for Reproduction
Chromium trioxide*	1333-82-0	215-607-8	N.D.	0.005	Carcinogen Mutagen
Acids generated from chromium trioxide and their oligomers:					
Chromic acid	7738-94-5	231-801-5	N.D.	0.005	Carcinogen
Dichromic acid	13530-68-2	236-881-5			
Oligomers of chromic acid and dichromic acid*					
1-methyl-2-pyrrolidone	872-50-4	212-828-1	N.D.	0.05	Toxic for Reproduction
2-ethoxyethyl acetate	111-15-9	203-839-2	N.D.	0.05	Toxic for Reproduction
1,2-benzenedicarboxylic acid, di-C6-8-branched alkyl esters, C7-rich	71888-89-6	276-158-1	N.D.	0.05	Toxic for Reproduction
1,2-benzenedicarboxylic acid, di-C7-11-branched and linear alkyl esters	68515-42-4	271-084-6	N.D.	0.05	Toxic for Reproduction
1,2,3-trichloropropane	96-18-4	202-486-1	N.D.	0.05	Carcinogen Toxic for Reproduction
Hydrazine	7803-57-8 302-01-2	206-114-9	N.D.	0.05	Carcinogen
Strontium chromate*	7789-06-2	232-142-6	N.D.	0.005	Carcinogen

This document is issued by the Company subject to its General Conditions of Service printed hereon, available on request or accessible at <http://www.sgs.com/en/Terms-and-Conditions.aspx> and, for electronic format documents, subject to Terms and Conditions for Electronic Documents at <http://www.sgs.com/en/e-documentation>. Attention is drawn to the limitation of liability, identification and protection issues defined therein. Any holder in the possession of this document is notified that the information contained herein reflects the Company's findings at the time of its issuance only and within the limits of its instructions, if any. The Company is sole responsible as to its Client and the document does not exonerate parties to a transaction from observing all their rights and obligations under the transaction documents. This document cannot be reproduced except in full, without prior written approval of the Company. Any unauthorized alteration, forgery or falsification of the content or appearance of this document is unlawful and offenders may be prosecuted to the fullest extent of the law. Unless otherwise stated the results shown in this test report refer only to the samples tested and such samples are retained for 90 days only.

F052 Version 5

SGS Korea Co., Ltd.

322, The C valley, 555-9, Hogya-dong, Dongan-gu, Anyang-si, Gyeonggi-do, Korea 431-080
t +82 (0)31 4608 000 f +82 (0)31 4608 050 <http://www.sgslab.co.kr/www.kr.sgs.com/gaenlab>

Member of the SGS Group (Société Générale de Surveillance)

Substance Name	CAS number	EC number	Concentration (%)	Reporting Limit (%)	Classification
1,2-Dichloroethane	107-06-2	203-458-1	N.D.	0.05	Carcinogenic
2,2'-dichloro-4,4'-methylenedianiline (MOCA)	101-14-4	202-918-9	N.D.	0.05	Carcinogenic
2-Methoxyaniline o-Anisidine	90-04-0	201-963-1	N.D.	0.05	Carcinogenic
4-(1,1,3,3-tetramethylbutyl) phenol, (4-tert-Octylphenol)	140-66-9	205-426-2	N.D.	0.05	Equivalent level of concern having probable serious effects to the environment
Aluminosilicate Refractory Ceramic Fibres* (RCF)	650-017-00-8 (Index no.)	-	N.D.	0.005	Carcinogenic
Arsenic acid*	7778-39-4	231-901-9	N.D.	0.005	Carcinogenic
Bis(2-methoxyethyl) ether	111-96-6	203-924-4	N.D.	0.05	Toxic for reproduction
Bis(2-methoxyethyl) phthalate	117-82-8	204-212-6-	N.D.	0.05	Toxic for reproduction
Calcium arsenate*	7778-44-1	231-904-5	N.D.	0.005	Carcinogenic
Dichromium tris(chromate)*	24613-89-6	246-356-2	N.D.	0.005	Carcinogenic
Formaldehyde, oligomeric reaction products with aniline (technical MDA)	25214-70-4	500-036-1	N.D.	0.05	Carcinogenic
Lead diazide*	13424-46-9	236-542-1	N.D.	0.005	Toxic for reproduction
Lead dipicrate*	6477-64-1	229-335-2	N.D.	0.005	Toxic for reproduction
Lead styphnate*	15245-44-0	239-290-2	N.D.	0.005	Toxic for reproduction
N,N-dimethylacetamide (DMAC)	127-19-5	204-826-4	N.D.	0.05	Toxic for reproduction
Pentazinc chromate octahydroxide*	49663-84-5	256-418-0	N.D.	0.005	Carcinogenic
Phenolphthalein	77-09-8	201-004-7	N.D.	0.05	Carcinogenic
Potassium hydroxyocta-oxodizincatedichromate*	11103-86-9	234-329-8	N.D.	0.005	Carcinogenic
Trilead diarsenate*	3687-31-8	222-979-5	N.D.	0.005	Carcinogenic Toxic for reproduction
Zirconia Aluminosilicate Refractory Ceramic Fibres (Zr-RCF)*	650-017-00-8 (Index no.)	-	N.D.	0.005	Carcinogenic

This document is issued by the Company subject to its General Conditions of Service printed hereon, available on request or accessible at <http://www.sgs.com/en/Terms-and-Conditions.aspx> and, for electronic format documents, subject to Terms and Conditions for Electronic Documents at <http://www.sgs.com/en/e-documents>. Attention is drawn to the limitation of liability, identification and protection issues defined therein. Any holder in the possession of this document is notified that the information contained herein reflects the Company's findings at the time of its issuance only and within the limits of its instructions, if any. The Company is sole responsible as to its Client and the document does not exonerate parties to a transaction from exercising all their rights and obligations under the transaction documents. This document cannot be reproduced or copy in full, without prior written approval of the Company. Any unauthorized alteration, forgery or falsification of the content or appearance of this document is unlawful and offenders may be prosecuted to the fullest extent of the law. Unless otherwise stated the results shown in this test report refer only to the samples tested and such samples are related to this page only.

F052 Version 5

SGS Korea Co., Ltd.

322, The C valley, 555-9, Hoga-dong, Dongan-gu, Anyang-si, Gyeonggi-do, Korea 431-080
t +82 (0)31 4608 000 f +82 (0)31 4608 050 <http://www.sgslab.co.kr> www.kr.sgs.com/globalsab

Member of the SGS Group (Société Générale de Surveillance)

Substance Name	CAS number	EC number	Concentration (%)	Reporting Limit (%)	Classification
1,2-bis(2-methoxyethoxy) ethane (TEGDME; triglyme)	112-49-2	203-977-3	N.D.	0.05	Toxic for reproduction
1,2-dimethoxyethane; ethylene glycol dimethyl ether (EGDME)	110-71-4	203-794-9	N.D.	0.05	Toxic for reproduction
Diboron trioxide*	1303-86-2	215-125-8	N.A.	0.005	Toxic for reproduction
Formamide	75-12-7	200-842-0	N.D.	0.05	Toxic for reproduction
Lead(II) bis(methanesulfonate)*	17570-76-2	401-750-5	N.D.	0.005	Toxic for reproduction
TGIC(1,3,5-tris (oxiranyl methyl)-1,3,5-triazine-2,4,6-(1H,3H,5H)-trione)	2451-62-9	219-514-3	N.D.	0.05	Mutagenic
β -TGIC (1,3,5-tris[(2S and 2R)-2,3-epoxypropyl]-1,3,5-triazine-2,4,6-(1H,3H,5H)-trione)**	59653-74-6	423-400-0	N.D.	0.05	Mutagenic
4,4'-bis(dimethylamino) benzophenone (Michler's ketone)	90-94-8	202-027-5	N.D.	0.05	Carcinogenic
N,N,N',N'-tetramethyl-4,4'-methylenedianiline (Michler's base)	101-61-1	202-959-2	N.D.	0.05	Carcinogenic
[4-[4,4'-bis(dimethylamino) benzhydrylidene]cyclohexa-2,5-dien-1-ylidene] dimethylammonium chloride (C.I. Basic Violet 3)	548-62-9	208-953-6	N.D.	0.05	Carcinogenic
[4-[[4-anilino-1-naphthyl][4-(dimethylamino)phenyl]methylene]cyclohexa-2,5-dien-1-ylidene] dimethylammonium chloride (C.I. Basic Blue 26)	2580-56-5	219-943-6	N.D.	0.05	Carcinogenic
α,α -Bis[4-(dimethylamino) phenyl]-4 (phenylamino) naphthalene-1-methanol (C.I. Solvent Blue 4)	6786-83-0	229-851-8	N.D.	0.05	Carcinogenic
4,4'-bis(dimethylamino)-4''-(methylamino)trityl alcohol	561-41-1	209-218-2	N.D.	0.05	Carcinogenic

This document is issued by the Company subject to its General Conditions of Service printed hereon, available on request or accessible at <http://www.sgs.com/en/Terms-and-Conditions.aspx> and, for electronic format documents, subject to Terms and Conditions for Electronic Documents at <http://www.sgs.com/en/e-documentation>. Client's attention is drawn to the limitation of liability, identification and jurisdiction issue defined therein. Any holder of this document is advised that the information contained herein reflects the Company's findings at the time of its issuance only and within the limits of its methodology, if any. The Company is sole responsible as to its Client and the document does not exonerate parties to a transaction from checking all their rights and obligations under the transaction documents. This document cannot be reproduced or copied in full, without prior written approval of the Company. Any unauthorized alteration, forgery or falsification of the content or appearance of this document is unlawful and offenders may be prosecuted to the fullest extent of the law. Unless otherwise stated the results shown in this test report refer only to the samples tested and such samples are retained for 90 days only.

F052 Version 5

SGS Korea Co., Ltd.

322, The O valley, 555-9, Hoggae-dong, Dongan-gu, Anyang-si, Gyeonggi-do, Korea 431-080
t +82 (0)31 4608 000 f +82 (0)31 4608 050 <http://www.sgslab.co.kr> www.kr.sgs.com/globalsab

Member of the SGS Group (Société Générale de Surveillance)

Substance Name	CAS number	EC number	Concentration (%)	Reporting Limit (%)	Classification
Bis(pentabromophenyl) ether (DecaBDE)	1163-19-5	214-604-9	N.D.	0.05	PBT vPvB
Pentacosafuorotridecanoic acid	72629-94-8	276-745-2	N.D.	0.05	vPvB
Tricosafuorododecanoic acid	307-55-1	206-203-2	N.D.	0.05	vPvB
Henicosafuoroundecanoic acid	2058-94-8	218-165-4	N.D.	0.05	vPvB
Heptacosafuorotetradecanoic acid	376-06-7	206-803-4	N.D.	0.05	vPvB
4-(1,1,3,3-tetramethylbutyl) phenol, ethoxylated - covering well-defined substances and UVCB substances, polymers and homologues	-	-	N.D.	0.05	Equivalent level of concern - probable serious effects on the environment
4-Nonylphenol, branched and linear – substances with a linear and/or branched alkyl chain with a carbon number of 9 covalently bound in position 4 to phenol, covering also UVCB- and well-defined substances which include any of the individual isomers or a combination thereof	-	-	N.D.	0.05	Equivalent level of concern - probable serious effects on the environment
Diazene-1,2-dicarboxamide (C,C'-azodi(formamide))	123-77-3	204-650-8	N.D.	0.05	Equivalent level of concern - probable serious effects on human health
Cyclohexane-1,2-dicarboxylic anhydride (Hexahydrophthalic anhydride - HHPA)	85-42-7	201-604-9	N.D.	0.05	Equivalent level of concern - probable serious effects on human health

This document is issued by the Company subject to its General Conditions of Service printed hereon, available on request or accessible at <http://www.sgs.com/en/Terms-and-Conditions.aspx> and, for electronic format documents, subject to Terms and Conditions for Electronic Documents at <http://www.sgs.com/en/e-documents>. Attention is drawn to the limitation of liability, identification and jurisdiction issue defined therein. Any holder of this document is advised that the information contained herein reflects the Company's findings at the time of its issuance only and within the limits of its instructions, if any. The Company is sole responsible as to its Client and the document does not exonerate parties to a transaction from exercising all their rights and obligations under the transaction documents. This document cannot be reproduced or copied in full, without prior written approval of the Company. Any unauthorized alteration, forgery or falsification of the content or appearance of this document is unlawful and offenders may be prosecuted to the fullest extent of the law. Unless otherwise stated the results shown in this test report refer only to the samples tested and such samples are related to no other only.

F052 Version 5

SGS Korea Co., Ltd.

322, The C valley, 555-9, Hoga-dong, Dongan-gu, Anyang-si, Gyeonggi-do, Korea 431-080
t +82 (0)31 4608 000 f +82 (0)31 4608 050 <http://www.sgslab.co.kr> www.kr.sgs.com/sgslab

Member of the SGS Group (Société Générale de Surveillance)

Substance Name	CAS number	EC number	Concentration (%)	Reporting Limit (%)	Classification
Hexahydromethylphthalic anhydride, Hexahydro-4-methylphthalic anhydride, Hexahydro-1-methylphthalic anhydride, Hexahydro-3-methylphthalic anhydride	25550-51-0, 19438-60-9, 48122-14-1, 57110-29-9	247-094-1, 243-072-0, 256-356-4, 260-566-1	N.D.	0.05	Equivalent level of concern - probable serious effects on human health
Methoxy acetic acid	625-45-6	210-894-6	N.D.	0.05	Toxic for reproduction equivalent level of concern - probable serious effects on human health and the environment
1,2-Benzenedicarboxylic acid, dipentylester, branched and linear	84777-06-0	284-032-2	N.D.	0.05	Toxic for reproduction
Diisopentylphthalate (DIPP)	605-50-5	210-088-4	N.D.	0.05	Toxic for reproduction
N-pentyl-isopentylphthalate	-	-	N.D.	0.05	Toxic for reproduction
1,2-Diethoxyethane	629-14-1	211-076-1	N.D.	0.05	Toxic for reproduction
N,N-dimethylformamide; dimethyl formamide	68-12-2	200-679-5	N.D.	0.05	Toxic for reproduction
Dibutyltin dichloride (DBT)	683-18-1	211-670-0	N.D.	0.05	Toxic for reproduction
Acetic acid, lead salt, basic*	51404-69-4	257-175-3	N.D.	0.005	Toxic for reproduction
Basic lead carbonate (trilead bis(carbonate)dihydroxide)*	1319-46-6	215-290-6	N.D.	0.005	Toxic for reproduction
Lead oxide sulfate (basic lead sulfate)*	12036-76-9	234-853-7	N.D.	0.005	Toxic for reproduction
[Phthalato(2-)]dioxotrilead (dibasic lead phthalate)*	69011-06-9	273-688-5	N.D.	0.005	Toxic for reproduction

This document is issued by the Company subject to its General Conditions of Service printed herein, available on request or accessible at <http://www.sgs.com/en/Terms-and-Conditions.aspx> and, for electronic format documents, subject to Terms and Conditions for Electronic Documents at <http://www.sgs.com/en/e-document.aspx>. Attention is drawn to the limitation of liability, identification and jurisdiction issue defined therein. Any holder of this document is advised that the information contained herein reflects the Company's findings at the time of its issuance only and within the limits of its instructions, if any. The Company is sole responsible as to its Client and the document does not exonerate parties to a transaction from exercising all their rights and obligations under the transaction documents. This document cannot be reproduced or copy in full, without prior written approval of the Company. Any unauthorized alteration, forgery or falsification of the content or appearance of this document is unlawful and offenders may be prosecuted to the fullest extent of the law. Unless otherwise stated the results shown in this test report refer only to the samples tested and such samples are related to no page only.

F052 Version 5

SGS Korea Co., Ltd.

322, The C valley, 555-9, Hoga-dong, Dongan-gu, Anyang-si, Gyeonggi-do, Korea 431-080
t +82 (0)31 4608 000 f +82 (0)31 4608 050 <http://www.sgslab.co.kr> www.kr.sgs.com/gaenlab

Member of the SGS Group (Société Générale de Surveillance)

Substance Name	CAS number	EC number	Concentration (%)	Reporting Limit (%)	Classification
Dioxobis(stearato)trilead*	12578-12-0	235-702-8	N.D.	0.005	Toxic for reproduction
Fatty acids, C16-18, lead salts*	91031-62-8	292-966-7	N.D.	0.005	Toxic for reproduction
Lead bis(tetrafluoroborate)*	13814-96-5	237-486-0	N.D.	0.005	Toxic for reproduction
Lead cyanamidate*	20837-86-9	244-073-9	N.D.	0.005	Toxic for reproduction
Lead dinitrate*	10099-74-8	233-245-9	N.D.	0.005	Toxic for reproduction
Lead oxide (lead monoxide)*	1317-36-8	215-267-0	N.D.	0.005	Toxic for reproduction
Lead tetroxide (orange lead)*	1314-41-6	215-235-6	N.D.	0.005	Toxic for reproduction
Lead titanium trioxide*	12060-00-3	235-038-9	N.D.	0.005	Toxic for reproduction
Lead Titanium Zirconium Oxide*	12626-81-2	235-727-4	N.D.	0.005	Toxic for reproduction
Pentalead tetraoxide sulphate*	12065-90-6	235-067-7	N.D.	0.005	Toxic for reproduction
Pyrochlore, antimony lead yellow*	8012-00-8	232-382-1	N.D.	0.005	Toxic for reproduction
Silicic acid, barium salt, lead-doped*	68784-75-8	272-271-5	N.D.	0.005	Toxic for reproduction
Silicic acid, lead salt*	11120-22-2	234-363-3	N.D.	0.005	Toxic for reproduction
Sulfurous acid, lead salt, dibasic*	62229-08-7	263-467-1	N.D.	0.005	Toxic for reproduction
Tetraethyllead*	78-00-2	201-075-4	N.D.	0.005	Toxic for reproduction
Tetralead trioxide sulphate*	12202-17-4	235-380-9	N.D.	0.005	Toxic for reproduction

This document is issued by the Company subject to its General Conditions of Service printed hereon, available on request or accessible at <http://www.sgs.com/en/Terms-and-Conditions.aspx> and, for electronic format documents, subject to Terms and Conditions for Electronic Documents at <http://www.sgs.com/en/e-documentation>. Client's attention is drawn to the limitation of liability, identification and jurisdiction issues defined therein. Any holder of this document is advised that the information contained herein reflects the Company's findings at the time of its issuance only and within the limits of its instructions, if any. The Company accepts no responsibility as to its Client and the document does not exonerate parties to a transaction from securing all their rights and obligations under the transaction documents. This document cannot be reproduced in part or in full, without prior written approval of the Company. Any unauthorized alteration, forgery or falsification of the content or appearance of this document is unlawful and offenders may be prosecuted to the fullest extent of the law. Unless otherwise stated the results shown in this test report refer only to the samples tested and such samples are retained for 90 days only.

F052 Version 5

SGS Korea Co., Ltd.

322, The C valley, 555-9, Hoggae-dong, Dongan-gu, Anyang-si, Gyeonggi-do, Korea 431-080
t +82 (0)31 4608 000 f +82 (0)31 4608 050 <http://www.sgslab.co.kr> www.kr.sgs.com/gaenlab

Member of the SGS Group (Société Générale de Surveillance)

Substance Name	CAS number	EC number	Concentration (%)	Reporting Limit (%)	Classification
Trilead dioxide phosphonate*	12141-20-7	235-252-2	N.D.	0.005	Toxic for reproduction
Furan	110-00-9	203-727-3	N.D.	0.05	Carcinogenic
Propylene oxide; 1,2-epoxypropane; methyloxirane	75-56-9	200-879-2	N.D.	0.05	Carcinogenic Mutagenic
Diethyl sulphate	64-67-5	200-589-6	N.D.	0.05	Carcinogenic Mutagenic
Dimethyl sulphate	77-78-1	201-058-1	N.D.	0.05	Carcinogenic
3-ethyl-2-methyl-2-(3-methylbutyl)-1,3-oxazolidine	143860-04-2	421-150-7	N.D.	0.05	Toxic for reproduction
Dinoseb	88-85-7	201-861-7	N.D.	0.05	Toxic for reproduction
4,4'-methylenedi-o-toluidine	838-88-0	212-658-8	N.D.	0.05	Carcinogenic
4,4'-oxydianiline and its salts	101-80-4	202-977-0	N.D.	0.05	Carcinogenic Mutagenic
4-Aminoazobenzene; 4-Phenylazoaniline	60-09-3	200-453-6	N.D.	0.05	Carcinogenic
4-methyl-m-phenylenediamine (2,4-toluene-diamine)	95-80-7	202-453-1	N.D.	0.05	Carcinogenic
6-methoxy-m-toluidine (p-cresidine)	120-71-8	204-419-1	N.D.	0.05	Carcinogenic
Biphenyl-4-ylamine	92-67-1	202-177-1	N.D.	0.05	Carcinogenic
o-aminoazotoluene	97-56-3	202-591-2	N.D.	0.05	Carcinogenic
o-Toluidine; 2-Aminotoluene	95-53-4	202-429-0	N.D.	0.05	Carcinogenic
N-methylacetamide	79-16-3	201-182-6	N.D.	0.05	Toxic for reproduction
1-bromopropane; n-propyl bromide	106-94-5	203-445-0	N.D.	0.05	Toxic for reproduction

This document is issued by the Company subject to its General Conditions of Service printed hereon, available on request or accessible at <http://www.sgs.com/en/Terms-and-Conditions.aspx> and, for electronic format documents, subject to Terms and Conditions for Electronic Documents at <http://www.sgs.com/en/e-documents.aspx>. A client is drawn to the limitation of liability, identification and protection issues defined therein. Any holder of this document is advised that the information contained herein reflects the Company's findings at the time of its issuance only and within the limits of its instructions, if any. The Company is sole responsible as to its Client and the document does not exonerate parties to a transaction from exercising all their rights and obligations under the transaction documents. This document cannot be reproduced in part or in full, without prior written approval of the Company. Any unauthorized alteration, forgery or falsification of the content or appearance of this document is unlawful and offenders may be prosecuted to the fullest extent of the law. Unless otherwise stated the results shown in this test report refer only to the samples tested and such samples are related to the page only.

F052 Version 5

SGS Korea Co., Ltd.

322, The C valley, 555-9, Hoga-dong, Dongan-gu, Anyang-si, Gyeonggi-do, Korea 431-080
t +82 (0)31 4608 000 f +82 (0)31 4608 050 <http://www.sgslab.co.kr> www.kr.sgs.com/gaenlab

Member of the SGS Group (Société Générale de Surveillance)

Substance Name	CAS number	EC number	Concentration (%)	Reporting Limit (%)	Classification
Cadmium	7440-43-9	231-152-8	N.D.	0.005	Carcinogenic
Cadmium oxide	1306-19-0	215-146-2	N.D.	0.005	Carcinogenic
Dipentyl phthalate (DPP)	131-18-0	205-017-9	N.D.	0.05	Toxic for reproduction
4-Nonylphenol, branched and linear, ethoxylated [substances with a linear and/or branched alkyl chain with a carbon number of 9 covalently bound in position 4 to phenol, ethoxylated covering UVCB- and well-defined substances, polymers and homologues, which include any of the individual isomers and/or combinations thereof]	-	-	N.D.	0.05	Equivalent level of concern having probable serious effects to the environment
Ammonium pentadecafluorooctanoate (APFO)	3825-26-1	223-320-4	N.D.	0.05	Toxic for reproduction
Pentadecafluorooctanoic acid (PFOA)	335-67-1	206-397-9	N.D.	0.05	Toxic for reproduction

This document is issued by the Company subject to its General Conditions of Service printed hereon, available on request or accessible at <http://www.sgs.com/en/Terms-and-Conditions.aspx> and, for electronic format documents, subject to Terms and Conditions for Electronic Documents at <http://www.sgs.com/en/e-documentation>. Attention is drawn to the limitation of liability, identification and jurisdiction issue defined therein. Any holder of this document is advised that the information contained herein reflects the Company's findings at the time of its issuance only and within the limits of its technical competence. If any. The Company is sole responsible as to its Client and the document does not exonerate parties to a transaction from observing all their rights and obligations under the transaction documents. This document cannot be reproduced except in full, without prior written approval of the Company. Any unauthorized alteration, forgery or falsification of the content or appearance of this document is unlawful and offenders may be prosecuted to the fullest extent of the law. Unless otherwise stated the results shown in this test report refer only to the samples tested and such samples are related to no page only.

F052 Version 5

SGS Korea Co., Ltd.

322, The C valley, 555-9, Hoga-dong, Dongan-gu, Anyang-si, Gyeonggi-do, Korea 431-080
t +82 (0)31 4608 000 f +82 (0)31 4608 050 <http://www.sgslab.co.kr> www.kr.sgs.com/globalsite

Member of the SGS Group (Société Générale de Surveillance)

Substance Name	CAS number	EC number	Concentration (%)	Reporting Limit (%)	Classification
Diethyl phthalate	84-75-3	201-559-5	N.D.	0.05	Toxic for reproduction
Triethyl phosphate	25155-23-1	246-677-8	N.D.	0.05	Toxic for reproduction
Imidazolidine-2-thione; 2-imidazoline-2-thiol	96-45-7	202-506-9	N.D.	0.05	Toxic for reproduction
Disodium 4-amino-3-[[[4'-[(2,4-diaminophenyl)azo][1,1'-biphenyl]-4-yl]azo]-5-hydroxy-6-(phenylazo)naphthalene-2,7-disulphonate (C.I. Direct Black 38)	1937-37-7	217-710-3	N.D.	0.05	Carcinogenic
Disodium 3,3'-[[[1,1'-biphenyl]-4,4'-diylbis(azo)]bis(4-aminonaphthalene-1-sulphonate) (C.I. Direct Red 28)	573-58-0	209-358-4	N.D.	0.05	Carcinogenic
Cadmium sulphide	1306-23-6	215-147-8	N.D.	0.005	Carcinogenic Equivalent level of concern having probable serious effects to human health
Lead di(acetate)	301-04-2	206-104-4	N.D.	0.005	Toxic for reproduction

This document is issued by the Company subject to its General Conditions of Service printed herein, available on request or accessible at <http://www.sgs.com/en/Terms-and-Conditions.aspx> and, for electronic format documents, subject to Terms and Conditions for Electronic Documents at <http://www.sgs.com/en/e-documents.aspx>. Client's attention is drawn to the limitation of liability, identification and production issues defined therein. Any holder of this document is advised that the information contained herein reflects the Company's findings at the time of its issuance only and within the limits of its instructions, if any. The Company is sole responsible as to its Client and the document does not constitute parties to a transaction from absolving all their rights and obligations under the transaction documents. This document cannot be reproduced except in full, without prior written approval of the Company. Any unauthorized alteration, forgery or falsification of the content or appearance of this document is unlawful and offenders may be prosecuted to the fullest extent of the law. Unless otherwise stated the results shown in this test report refer only to the samples tested and such samples are related to no other only.

F052 Version 5

SGS Korea Co., Ltd.

322, The C valley, 555-9, Hoge-dong, Dongan-gu, Anyang-si, Gyeonggi-do, Korea 431-080
t +82 (0)31 4608 000 f +82 (0)31 4608 050 <http://www.sgslab.co.kr> www.kr.sgs.com/gaenlab

Member of the SGS Group (Société Générale de Surveillance)

Note:

1. RL = Reporting Limit

2. N.D. = Not detected (lower than RL)

N.A. = Not applicable for respective material type.

The submitted sample was found to contain significant amount of specific element(s) of SVHC. Upon further test verification and also information provided from client, the possibility that the element(s) content originate from SVHC is very unlikely, even though their presence cannot be exclude entirely. It may be assumed that the detected element(s) have a non-SVHC source.

3. Definition of classification is listed in Appendix A of this report in accordance with 67/548/EEC and Regulation (EC) No 1907/2006. For detail information, Detail explanation is available at the following link:

<http://echa.europa.eu/web/quest/candidate-list-table> (Candidate list)

http://echa.europa.eu/proposals-to-identify-substances-of-very-high-concern-previous-consultations?p_p_id=substancetypelist_WAR_substanceportlet&p_p_lifecycle=0&p_p_state=normal&p_p_mode=view&p_p_col_id=column-1&p_p_col_pos=2&p_p_col_count=4&substancetypelis
(Proposals to identify SVHC consultations)

4. *.The test result is based on the calculation of selected element(s) / marker(s) and to the worst-case scenario. For detail information, please refer to the SGS REACH website: www.reach.sgs.com/substance-of-very-high-concern-analysis-information-page.htm

The client is advised to review the chemical formulation to ascertain above metal substances present in the article.

RL = 0.005% is evaluated for element (i.e. cobalt, arsenic, lead, sodium, chromium, chromium(VI), silicon, aluminum, zirconium, boron, and potassium respectively), except molybdenum RL=0.0005%

0.1% (w/w) = 1,000 ppm = 1,000 mg/kg

5. **.β-TGIC is one of the isomers for TGIC compounds and hence, tested together. The reported test result is based the proposed ratio as according to ECHA dossier.



*** End of Report ***

This document is issued by the Company subject to its General Conditions of Service printed hereon, available on request or accessible at <http://www.sgs.com/en/Terms-and-Conditions.aspx> and, for electronic format documents, subject to Terms and Conditions for Electronic Documents at <http://www.sgs.com/en/e-documentation>. Attention is drawn to the limitation of liability, identification and jurisdiction issue defined therein. Any holder in the document is notified that information obtained herein reflects the Company's findings at the time of its issuance only and within the limits of its analytical methods. If any. This Company is sole responsible as to its Client and this document does not exonerate parties to a transaction from reviewing all their rights and obligations under the transaction documents. This document cannot be reproduced or copy in full, without prior written approval of the Company. Any unauthorized alteration, forgery or falsification of the content or appearance of this document is unlawful and offenders may be prosecuted to the fullest extent of the law. Unless otherwise stated the results shown in this test report refer only to the samples tested and such samples are retained for 90 days only.

Appendix A
Classification Definition under 67/548/EEC and Regulation (EC) No 1907/2006

Carcinogen Category 1:	<u>Substances known to be carcinogenic to man.</u> There is sufficient evidence to establish a causal association between human exposure to a substance and the development of cancer.
Carcinogen Category 2:	<u>Substances which should be regarded as if they are carcinogenic to man.</u> There is sufficient evidence to provide a strong presumption that human exposure to a substance may result in the development of cancer. Generally on the basis of: - appropriate long-term animal studies - other relevant information.
Mutagen Category 1:	<u>Substances known to be mutagenic to man.</u> There is sufficient evidence to establish a causal association between human exposure to a substance and heritable genetic damage.
Mutagen Category 2:	<u>Substances which should be regarded as if they are mutagenic to man.</u> There is sufficient evidence to provide a strong presumption that human exposure to the substance may result in the development of heritable genetic damage, generally on the basis of: - appropriate animal studies, - other relevant information.
Toxic to Reproduction Category 1:	<u>Substances known to impair fertility in humans.</u> There is sufficient evidence to establish a causal relationship between human exposure to the substance and impaired fertility. <u>Substances known to cause developmental toxicity in humans.</u> There is sufficient evidence to establish a causal relationship between human exposure to the substance and subsequent developmental toxic effects in the progeny.
Toxic to Reproduction Category 2:	<u>Substances which should be regarded as if they impair fertility in humans.</u> There is sufficient evidence to provide a strong presumption that human exposure to the substance may result in impaired fertility on the basis of: - clear evidence in animal studies of impaired fertility in the absence of toxic effects, or, evidence of impaired fertility occurring at around the same dose levels as other toxic effects but which is not a secondary nonspecific consequence of the other toxic effects, - other relevant information. <u>Substances which should be regarded as if they cause developmental toxicity to humans.</u> There is sufficient evidence to provide a strong presumption that human exposure to the substance may result in developmental toxicity, generally on the basis of: - clear results in appropriate animal studies where effects have been observed in the absence of signs of marked maternal toxicity, or at around the same dose levels as other toxic effects but which are not a secondary non-specific consequence of the other toxic effects, - other relevant information.
PBT & vPvB:	Substances which are persistent, bioaccumulative and toxic (PBT) or very persistent and very bioaccumulative (vPvB) pose a particular challenge to the chemicals safety management. For these substances a "safe" concentration in the environment cannot be established with sufficient reliability.

This document is issued by the Company subject to its General Conditions of Service printed herein, available on request or accessible at <http://www.sgs.com/en/Terms-and-Conditions.aspx> and, for electronic format documents, subject to Terms and Conditions for Electronic Documents at <http://www.sgs.com/en/e-documents.aspx>. A client is drawn to the limitation of liability, identification and jurisdiction issue defined therein. Any holder of this document is advised that information contained herein reflects the Company's findings at the time of its issuance only and within the limits of its instructions, if any. The Company accepts responsibility as to its Client and this document does not exonerate parties to a transaction from observing all their rights and obligations under the transaction documents. This document cannot be reproduced or copy in full, without prior written approval of the Company. Any unauthorized alteration, forgery or falsification of the content or appearance of this document is unlawful and offenders may be prosecuted to the fullest extent of the law. Unless otherwise stated the results shown in this test report refer only to the samples tested and such samples are related to no page only.

F052 Version 5

SGS Korea Co., Ltd.

 322, The C valley, 555-9, Hogya-dong, Dongan-gu, Anyang-si, Gyeonggi-do, Korea 431-080
 t +82 (0)31 4608 000 f +82 (0)31 4608 059 <http://www.sgslab.co.kr> www.kr.sgs.com/gaenlab

Member of the SGS Group (Société Générale de Surveillance)



Revision History

Date	No	Revision History	Writer	
			Drawn	Approved
2014.03.20	000	New version	T.J KIM	M.Y Son

X-ON Electronics

Largest Supplier of Electrical and Electronic Components

Click to view similar products for [High Power LEDs - White category](#):

Click to view products by [Samsung manufacturer](#):

Other Similar products are found below :

[G42180-08](#) [B42180-08](#) [STW8Q2PA-R5-HA](#) [SZ5-M1-W0-00-V3/W2-AA](#) [LTPL-P00DWS57](#) [LZP-D0WW00-0000](#) [CLM-9-30-90-36-AC32-F4-3](#) [SZ5-M1-WW-C8-V1/V3-FA](#) [BXRC-27E2000-D-73](#) [BXRC-27G2000-D-73](#) [BXRC-30E1000-D-73](#) [BXRC-30G2000-D-73](#) [BXRC-40E1000-D-73](#) [BXRE-30G2000-B-73](#) [BXRE-30G2000-C-73](#) [BXRE-50C2001-C-74](#) [CXM-22-27-80-54-AC30-F4-3](#) [XHP50B-00-0000-0D0UH245G](#) [XHP50B-00-0000-0D0UH240G](#) [XHP50B-00-0000-0D0HJ245G](#) [MP-5050-8100-27-80](#) [MP-5050-6100-65-80](#) [MP-5050-6100-50-80](#) [MP-5050-6100-40-80](#) [MP-5050-6100-30-80](#) [CXM-22-30-80-54-AC30-F4-3](#) [LTW-2835SZK57](#) [BXEM-50C0000-0-000](#) [WW-WNA30TS-U1\(M1\)](#) [KW CSLPM2.CC-8L8M-4L8N](#) [KW CSLPM2.CC-8L8M-4O9Q](#) [KW DPLS32.SB-6H6J-E5P7-EG-Z264](#) [L1V1-507003V500000](#) [CXM-22-35-80-36-AC10-F3-3](#) [KW3 CGLNM1.TG-Z6QF6-EBVFFCBB46-DFGA](#) [JB5630AWT-H-H65EA0000-NZ000001](#) [XHP50B-00-0000-0D0UG430H](#) [CXM-22-35-90-54-AC40-F5-3](#) [CXM-22-35-80-54-AC40-F5-3](#) [OSM51206E1N-0.8T](#) [OSW43020C1C](#) [MP161611032290](#) [MP-1616-2103-50-90](#) [KW CULPM1.TG-Z6RF7-ebvFfcbB46-65G5](#) [KW DMLS33.SG-Z6M7-EBVFFCBB46-8E8G-700-S](#) [XPGDWT-B1-0000-00EEA](#) [XHP70B-00-0000-0D0BP450E](#) [KW DMLN33.SG-7J7K-EBVFFCBB46-8E8G-200-S](#) [ASMT-MW05-NMNS1](#)
[ASMT-MW06-NMNZ1](#)