

Overview

The A72 Series is constructed of polypropylene film and metal foil or metallized film and metal foil with axial leads of tinned wire. The axial leads are electrically welded to the metal layer on the ends of the capacitor winding. The capacitor is encapsulated in a polyester tape wrapping case with thermosetting resin material. Two different winding constructions are used depending on voltage parameters. Please see the Performance Characteristics for more information.

Applications

Typical applications include switching spikes suppression and resonant capacitors in switched mode power supply (SMPS), and deflection circuits in televisions (S-correction and flyback tuning) as well as applications with high voltage and high current. Not suitable for across-the-line application (see Suppressor Capacitors).

Benefits

- Voltage range: 100 – 2,000 VDC
- Capacitance range: 47 pF – 0.33 μ F
- Diameter: 5 – 22.5 mm
- Length: 11 – 33 mm
- Capacitance tolerance: \pm 5%, \pm 10%, \pm 20%
- Climatic category: 55/105/56 IEC 60068-1
- Operating temperature range of -55°C to +105°C
- RoHS compliance and lead-free terminations
- Tape and reel packaging in accordance with IEC 60286-1
- Self-healing



Part Number System

A72	E	F	1470	AA	00	J
Series	Rated Voltage (VDC)	Length (mm)	Capacitance Code (pF)	Lead and Packaging Code	Internal Use	Capacitance Tolerance
Polypropylene Film/Foil	E = 100 I = 250 M = 400 P = 630 Q = 1000 S = 1500 U = 2000	F = 11 H = 14 K = 20.5 Q = 28 T = 33	Digits 2 – 4 indicate the first three digits of the capacitance value. First digit indicates the number of zeros to be added.	See Ordering Options Table	00, 02 (Standard)	J = \pm 5% K = \pm 10% M = \pm 20%

Ordering Options Table

Type of Leads and Packaging	Lead Length (mm)	Lead and Packaging Code
Bulk (Bag) – Straight Leads	40 +/-5	AA
Tape & Reel (Standard Reel)		26

Dimensions – Millimeters

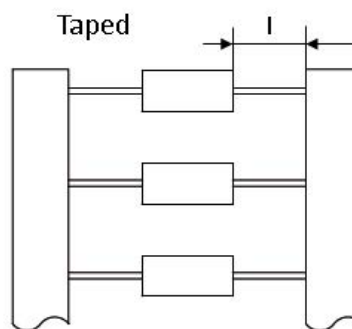
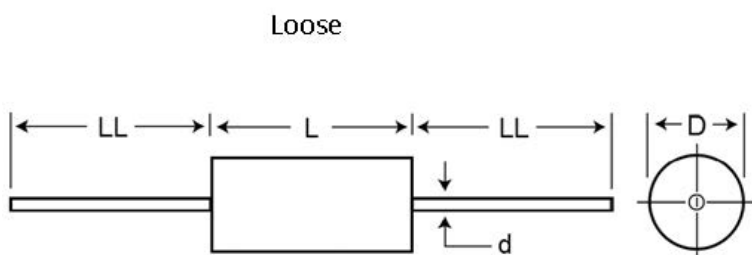

D		L		d	
Nominal	Tolerance	Nominal	Tolerance	Nominal	Tolerance
5.0	Maximum	11.0	Maximum	0.5	±0.05
6.5	Maximum	16.5	Maximum	0.6	±0.05
7.0	Maximum	16.5	Maximum	0.6	±0.05
7.5	Maximum	16.5	Maximum	0.6	±0.05
8.0	Maximum	16.5	Maximum	0.8	±0.05
8.0	Maximum	20.5	Maximum	0.8	±0.05
8.0	Maximum	28.0	Maximum	0.8	±0.05
8.5	Maximum	16.5	Maximum	0.8	±0.05
8.5	Maximum	20.5	Maximum	0.8	±0.05
8.5	Maximum	28.0	Maximum	0.8	±0.05
9.0	Maximum	16.5	Maximum	0.8	±0.05
9.0	Maximum	28.0	Maximum	0.8	±0.05
9.5	Maximum	20.5	Maximum	0.8	±0.05
9.5	Maximum	28.0	Maximum	0.8	±0.05
10.0	Maximum	28.0	Maximum	0.8	±0.05

Note: See Ordering Options Table for lead length (LL / l) options.

D		L		d	
Nominal	Tolerance	Nominal	Tolerance	Nominal	Tolerance
11.0	Maximum	20.5	Maximum	0.8	±0.05
11.0	Maximum	28.0	Maximum	0.8	±0.05
11.5	Maximum	28.0	Maximum	0.8	±0.05
12.5	Maximum	28.0	Maximum	0.8	±0.05
13.0	Maximum	28.0	Maximum	0.8	±0.05
13.5	Maximum	28.0	Maximum	0.8	±0.05
13.5	Maximum	33.0	Maximum	0.8	±0.05
14.0	Maximum	33.0	Maximum	0.8	±0.05
16.0	Maximum	33.0	Maximum	1.0	±0.05
16.5	Maximum	33.0	Maximum	1.0	±0.05
18.0	Maximum	33.0	Maximum	1.0	±0.05
19.0	Maximum	33.0	Maximum	1.0	±0.05
19.5	Maximum	33.0	Maximum	1.0	±0.05
20.0	Maximum	33.0	Maximum	1.0	±0.05
22.5	Maximum	33.0	Maximum	1.0	±0.05

Note: See Ordering Options Table for lead length (LL / l) options.

Performance Characteristics

Dielectric	Polypropylene film						
Plates	Metal foil for 1 section, metal foil + metallized film for 2 sections						
Winding	Non-inductive type						
Leads	Tinned wire						
Protection	Plastic case, thermosetting resin filled. Box material is solvent resistant and flame retardant according to UL94.						
Related Documents	IEC 60384-13						
Sections	1			2			
Voltage Range (VDC)	100	250	400	630	1000	1500	2000
Voltage Range (VAC)	63	125	160	300	400	450	500
Capacitance Range (μF)	0.0047 – 0.01	0.0022 – 0.015	0.000047 – 0.01	0.015 – 0.33	0.0033 – 0.1	0.0022 – 0.068	0.001 – 0.047
Capacitance Values	E6 series (IEC 60063) measured @ 1 kHz and +20 \pm 1°C						
Capacitance Tolerance	\pm 5%, \pm 10%, \pm 20%						
Operating temperature Range	-55°C to +105°C						
Rated Temperature T_R	+85°C						
Voltage Derating	Above +85°C DC and AC voltage derating is 1.25%/°C						
Climatic Category	55/105/56 IEC 60068-1						
	Average relative humidity \leq 75%						
	RH = 95% for 30 days per year						
	RH = 85% for further days limited by average value per year						
Test Voltage	2 x VR VDC for 2 s (between terminations) @ +25°C \pm 5°C						
Capacitance Drift	Maximum 0.5% after a 2 year storage period at a temperature of +10°C to +40°C and a relative humidity of 40% to 60%						
Maximum Pulse Steepness	dV/dt according to Table 1. For peak to peak voltages lower than rated voltage ($V_{pp} < V_R$), the specified dv/dt can be multiplied by the factor V_R/V_{pp}						
Temperature Coefficient	-(150 \pm 70) ppm/°C at 1 kHz						
Self Inductance (Lead Length ~ 2 mm)	Maximum 1 nH per 1 mm lead and capacitor length.						
Dissipation Factor $\tan\delta$	Measured at 25°C \pm 5°C						
	Frequency	$C \leq 0.1 \mu\text{F}$		$C \geq 0.1 \mu\text{F}$			
	10 kHz	0.05%		0.05%			
	100 kHz	0.10%		-			
Insulation Resistance	Measured at +25°C, 100 VDC 60 seconds						
	Minimum Values Between Terminals						
	All Capacitance Values						
	$\geq 100,000 \text{ M}\Omega$ ($\geq 500,000 \text{ M}\Omega$) *						

* typical value

Maximum Voltage (V_{rms}) vs. Frequency (Sinusoidal Waveform/ $Th \leq +40^\circ C$)

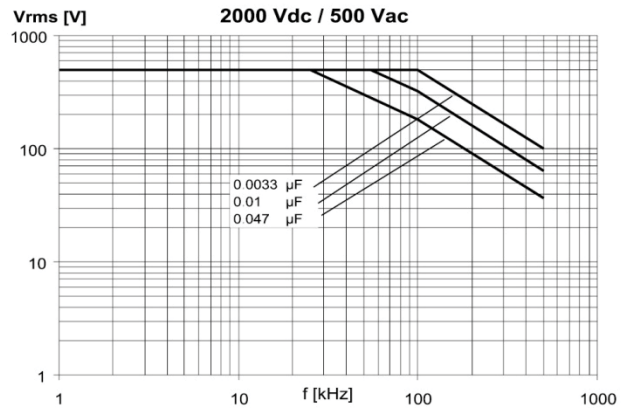
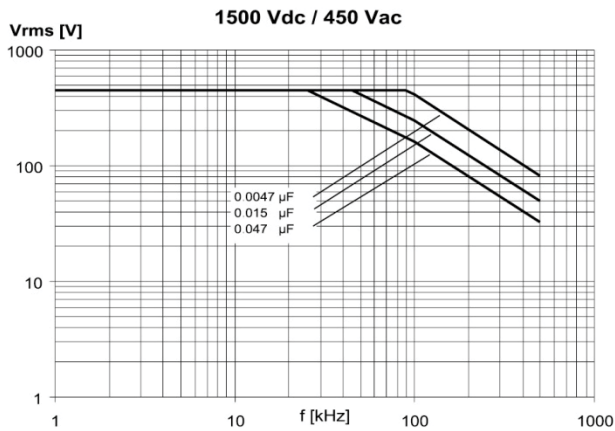
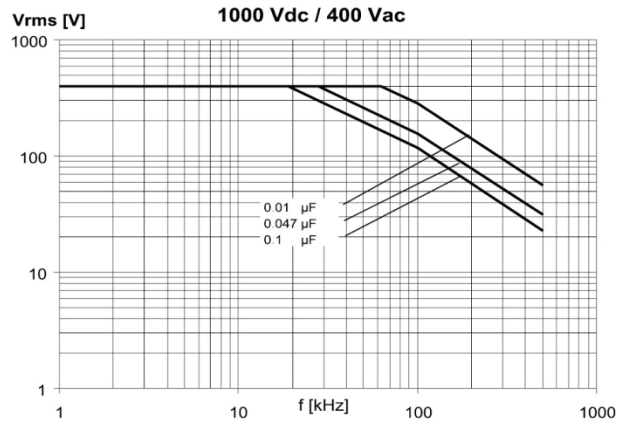
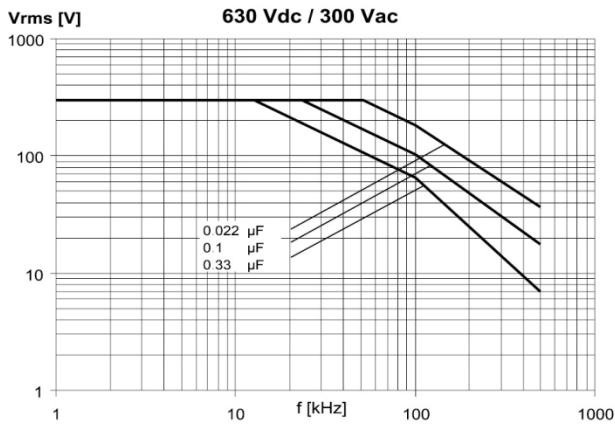
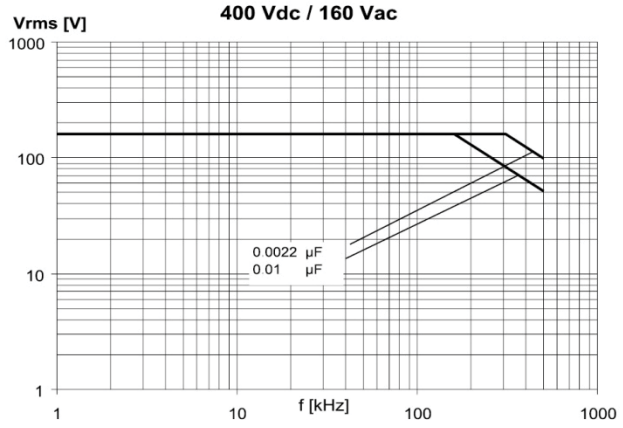
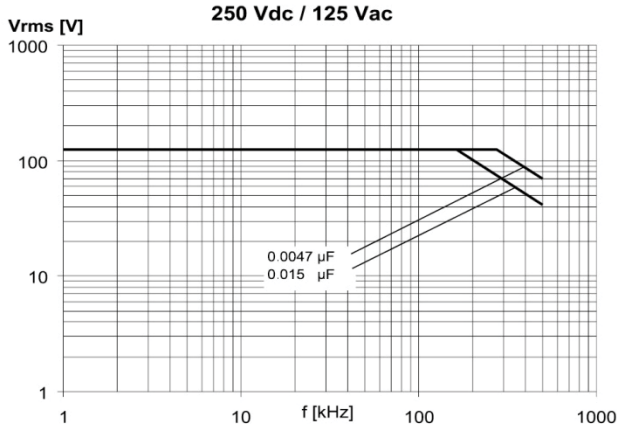

Maximum Current (I_{rms}) vs. Frequency (Sinusoidal Waveform/ $T_h \leq +40^\circ\text{C}$)

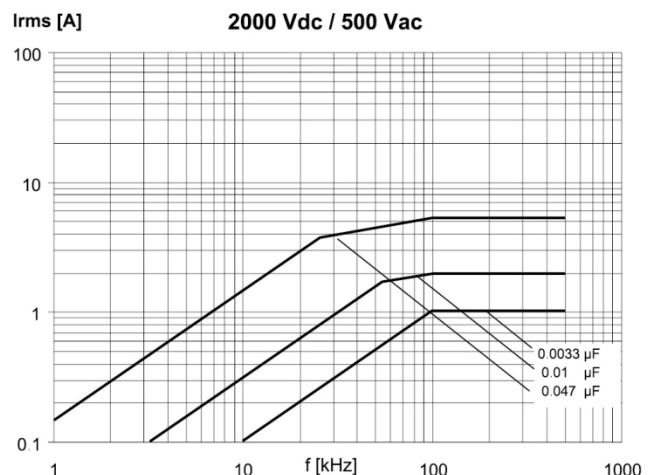
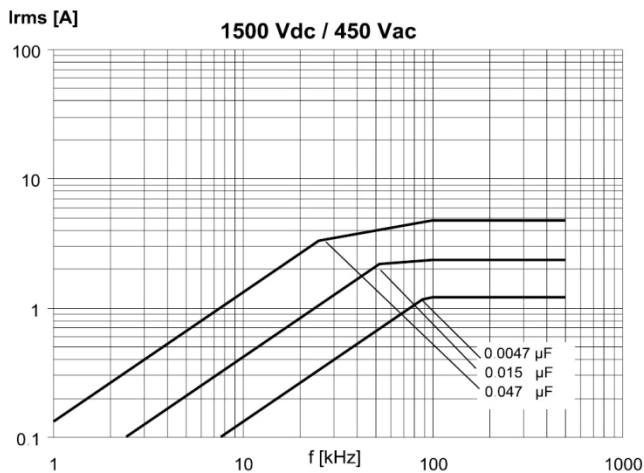
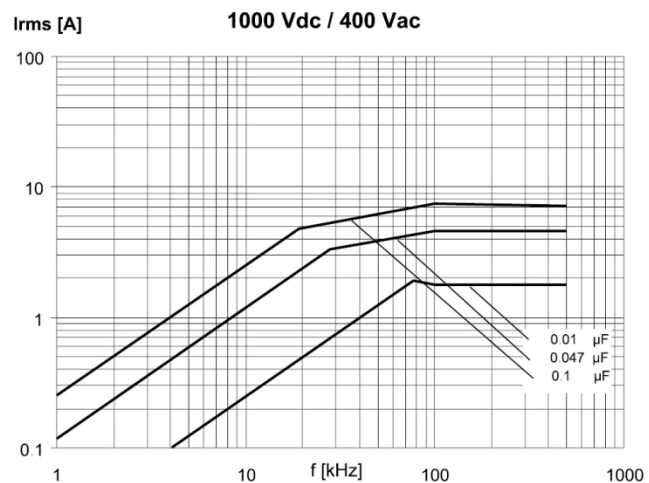
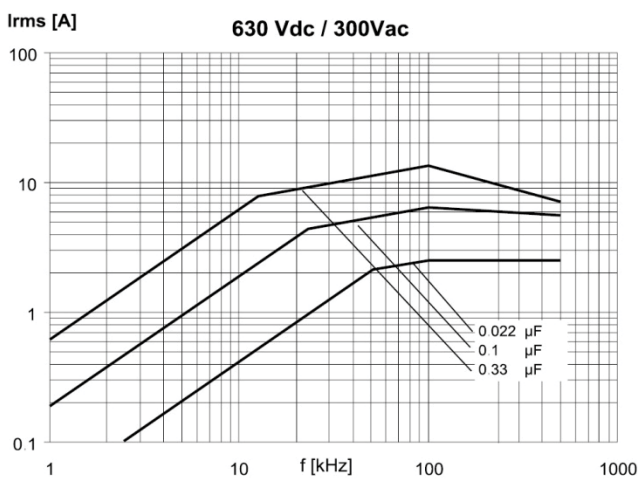
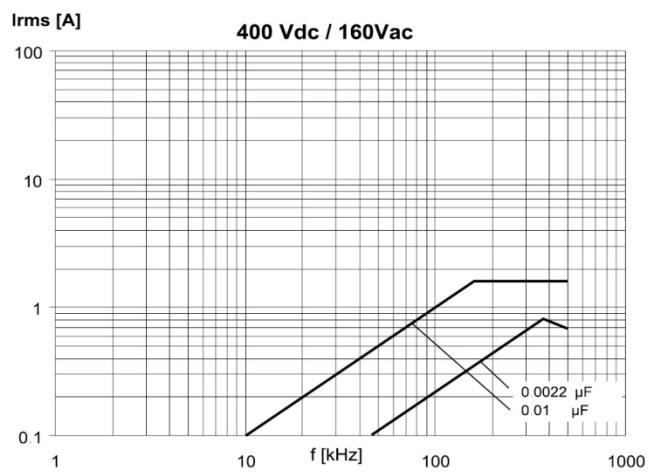
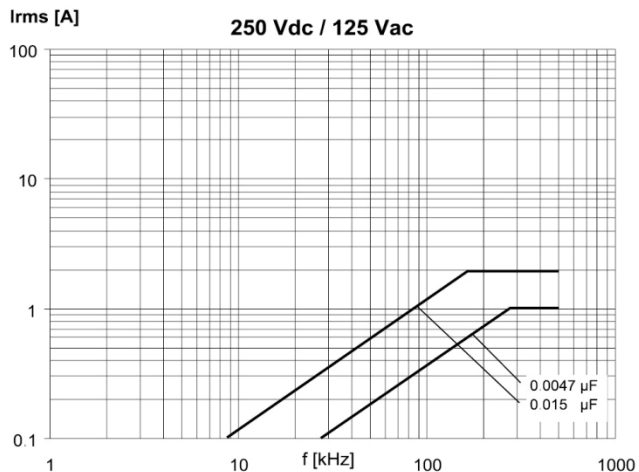

Environmental Test Data

Damp Heat, Steady State Test	Test Conditions:		Performances
	Temperature: Relative humidity (RH): Test duration:	+40°C ±2°C 93% ±2% 56 days	Δ C/C ≤ 2%, Δ tanδ ≤ 0.0005 @ 1 kHz IR after test ≥ 50% of initial limit
Endurance Test	Test Conditions		Performances
	Temperature: Voltage applied: Test duration:	+85°C ±2°C 1.5 x V _R (DC) 1,000 hours	Δ C/C ≤ 2%, Δ tanδ ≤ 0.0005 @ 1 kHz IR after test ≥ 50% of initial limit
Resistance to Soldering Heat Test	Test Conditions		Performances
	Solder bath temperature: Dipping time (with heat screen):	260°C ±5°C 10 seconds ±1 second	Δ C/C ≤ 1%, Δ tanδ ≤ 0.0005 @ 1 kHz IR after test ≥ initial limit

Environmental Compliance

All KEMET pulse capacitors are RoHS Compliant.



RoHS Compliant

Table 1 – Ratings & Part Number Reference

VDC	VAC	Capacitance Value (μF)	Dimensions in mm		dV/dt (V/μs)	Max K ₀ (V ² /μs)	New KEMET Part Number	Legacy Part Number
			D Max	L Max				
100	63	0.0047	5.0	11.0	3,000	600,000	72EF1470(1)00(2)	A72EF1470(1)00(2)
100	63	0.0068	5.0	11.0	3,000	600,000	72EF1680(1)00(2)	A72EF1680(1)00(2)
100	63	0.010	5.0	11.0	3,000	600,000	72EF2100(1)00(2)	A72EF2100(1)00(2)
250	125	0.0022	5.0	11.0	5,000	2,500,000	72IF1220(1)00(2)	A72IF1220(1)00(2)
250	125	0.0033	5.0	11.0	5,000	2,500,000	72IF1330(1)00(2)	A72IF1330(1)00(2)
250	125	0.0047	7.0	16.5	4,500	2,250,000	72II1470(1)00(2)	A72II1470(1)00(2)
250	125	0.0068	7.0	16.5	4,500	2,250,000	72II1680(1)00(2)	A72II1680(1)00(2)
250	125	0.010	7.5	16.5	4,500	2,250,000	72II2100(1)00(2)	A72II2100(1)00(2)
250	125	0.015	8.5	16.5	4,500	2,250,000	72II2150(1)00(2)	A72II2150(1)00(2)
400	160	0.000047	5.0	11.0	13,000	10,400,000	72MF0047(1)00(2)	A72MF0047(1)00(2)
400	160	0.000068	5.0	11.0	13,000	10,400,000	72MF0068(1)00(2)	A72MF0068(1)00(2)
400	160	0.00010	5.0	11.0	13,000	10,400,000	72MF0100(1)00(2)	A72MF0100(1)00(2)
400	160	0.00015	5.0	11.0	13,000	10,400,000	72MF0150(1)00(2)	A72MF0150(1)00(2)
400	160	0.00022	5.0	11.0	13,000	10,400,000	72MF0220(1)00(2)	A72MF0220(1)00(2)
VDC	VAC	Capacitance Value (μF)	B (mm)	H (mm)	dV/dt (V/μs)	Max K ₀ (V ² /μs)	New KEMET Part Number	Legacy Part Number

(1) Insert lead and packaging code. See Ordering Options Table for available options.

(2) J = 5%, K = 10%, M = 20%.

Table 1 – Ratings & Part Number Reference cont'd

VDC	VAC	Capacitance Value (µF)	Dimensions in mm		dV/dt (V/µs)	Max K ₀ (V ² /µs)	New KEMET Part Number	Legacy Part Number
			D Max	L Max				
400	160	0.00033	5.0	11.0	13,000	10,400,000	72MF0330(1)00(2)	A72MF0330(1)00(2)
400	160	0.00047	5.0	11.0	13,000	10,400,000	72MF0470(1)00(2)	A72MF0470(1)00(2)
400	160	0.00068	5.0	11.0	13,000	10,400,000	72MF0680(1)00(2)	A72MF0680(1)00(2)
400	160	0.0010	5.0	11.0	13,000	10,400,000	72MF1100(1)00(2)	A72MF1100(1)00(2)
400	160	0.0015	5.0	11.0	13,000	10,400,000	72MF1150(1)00(2)	A72MF1150(1)00(2)
400	160	0.0022	6.5	16.5	6,500	5,200,000	72MI1220(1)00(2)	A72MI1220(1)00(2)
400	160	0.0033	6.5	16.5	6,500	5,200,000	72MI1330(1)00(2)	A72MI1330(1)00(2)
400	160	0.0047	7.0	16.5	6,500	5,200,000	72MI1470(1)00(2)	A72MI1470(1)00(2)
400	160	0.0068	8.0	16.5	6,500	5,200,000	72MI1680(1)00(2)	A72MI1680(1)00(2)
400	160	0.010	9.0	16.5	6,500	5,200,000	72MI2100(1)00(2)	A72MI2100(1)00(2)
630	300	0.015	8.5	20.5	4,300	5,418,000	72PK2150(1)00(2)	A72PK2150(1)00(2)
630	300	0.022	9.5	20.5	4,300	5,418,000	72PK2220(1)00(2)	A72PK2220(1)00(2)
630	300	0.033	9.0	28.0	2,600	3,276,000	72PQ2330(1)00(2)	A72PQ2330(1)00(2)
630	300	0.047	10.0	28.0	2,600	3,276,000	72PQ2470(1)00(2)	A72PQ2470(1)00(2)
630	300	0.068	11.5	28.0	2,600	3,276,000	72PQ2680(1)00(2)	A72PQ2680(1)00(2)
630	300	0.10	13.5	28.0	2,600	3,276,000	72PQ3100(1)00(2)	A72PQ3100(1)00(2)
630	300	0.15	14.0	33.0	1,800	2,268,000	72PT3150(1)00(2)	A72PT3150(1)00(2)
630	300	0.22	16.5	33.0	1,800	2,268,000	72PT3220(1)00(2)	A72PT3220(1)00(2)
630	300	0.33	19.5	33.0	1,800	2,268,000	72PT3330(1)00(2)	A72PT3330(1)00(2)
1,000	400	0.0033	8.5	20.5	14,000	28,000,000	72QK1330(1)02(2)	A72QK1330(1)02(2)
1,000	400	0.0047	9.5	20.5	14,000	28,000,000	72QK1470(1)02(2)	A72QK1470(1)02(2)
1,000	400	0.0068	8.0	28.0	5,000	10,000,000	72QQ1680(1)02(2)	A72QQ1680(1)02(2)
1,000	400	0.010	8.5	28.0	5,000	10,000,000	72QQ2100(1)02(2)	A72QQ2100(1)02(2)
1,000	400	0.015	10.0	28.0	5,000	10,000,000	72QQ2150(1)02(2)	A72QQ2150(1)02(2)
1,000	400	0.022	11.0	28.0	5,000	10,000,000	72QQ2220(1)02(2)	A72QQ2220(1)02(2)
1,000	400	0.033	13.0	28.0	5,000	10,000,000	72QQ2330(1)02(2)	A72QQ2330(1)02(2)
1,000	400	0.047	14.0	33.0	3,700	7,400,000	72QT2470(1)02(2)	A72QT2470(1)02(2)
1,000	400	0.068	16.0	33.0	3,700	7,400,000	72QT2680(1)02(2)	A72QT2680(1)02(2)
1,000	400	0.10	19.0	33.0	3,700	7,400,000	72QT3100(1)02(2)	A72QT3100(1)02(2)
1,500	450	0.0022	8.0	20.5	17,000	51,000,000	72SK1220(1)00(2)	A72SK1220(1)00(2)
1,500	450	0.0033	9.5	20.5	17,000	51,000,000	72SK1330(1)00(2)	A72SK1330(1)00(2)
1,500	450	0.0047	8.5	28.0	6,000	18,000,000	72SQ1470(1)00(2)	A72SQ1470(1)00(2)
1,500	450	0.0068	8.5	28.0	6,000	18,000,000	72SQ1680(1)00(2)	A72SQ1680(1)00(2)
1,500	450	0.010	9.5	28.0	6,000	18,000,000	72SQ2100(1)00(2)	A72SQ2100(1)00(2)
1,500	450	0.015	11.0	28.0	6,000	18,000,000	72SQ2150(1)00(2)	A72SQ2150(1)00(2)
1,500	450	0.022	12.5	28.0	6,000	18,000,000	72SQ2220(1)00(2)	A72SQ2220(1)00(2)
1,500	450	0.033	13.5	33.0	4,500	13,500,000	72ST2330(1)00(2)	A72ST2330(1)00(2)
1,500	450	0.047	16.0	33.0	4,500	13,500,000	72ST2470(1)00(2)	A72ST2470(1)00(2)
1,500	450	0.068	18.0	33.0	4,500	13,500,000	72ST2680(1)00(2)	A72ST2680(1)00(2)
2,000	500	0.0010	8.5	20.5	27,000	108,000,000	72UK1100(1)00(2)	A72UK1100(1)00(2)
2,000	500	0.0015	9.5	20.5	27,000	108,000,000	72UK1150(1)00(2)	A72UK1150(1)00(2)
2,000	500	0.0022	11.0	20.5	27,000	108,000,000	72UK1220(1)00(2)	A72UK1220(1)00(2)
2,000	500	0.0033	9.0	28.0	9,800	39,200,000	72UQ1330(1)00(2)	A72UQ1330(1)00(2)
2,000	500	0.0047	9.5	28.0	9,800	39,200,000	72UQ1470(1)00(2)	A72UQ1470(1)00(2)
2,000	500	0.0068	11.0	28.0	9,800	39,200,000	72UQ1680(1)00(2)	A72UQ1680(1)00(2)
VDC	VAC	Capacitance Value (µF)	B (mm)	H (mm)	dV/dt (V/µs)	Max K ₀ (V ² /µs)	New KEMET Part Number	Legacy Part Number

(1) Insert lead and packaging code. See Ordering Options Table for available options.

(2) J = 5%, K = 10%, M = 20%.

Soldering Process

The implementation of the RoHS directive has resulted in the selection of SnAgCu (SAC) alloys or SnCu alloys as primary solder. This has increased the liquidus temperature from that of 183°C for SnPb eutectic alloy to 217 – 221°C for the new alloys. As a result, the heat stress to the components, even in wave soldering, has increased considerably due to higher pre-heat and wave temperatures. Polypropylene capacitors are especially sensitive to heat (the melting point of polypropylene is 160 – 170°C). Wave soldering can be destructive, especially for mechanically small polypropylene capacitors (with lead spacing of 5 mm to 15 mm), and great care has to be taken during soldering. The recommended solder profiles from KEMET should be used. Please consult KEMET with any questions. In general, the wave soldering curve from IEC Publication 61760-1 Edition 2 serves as a solid guideline for successful soldering. Please see Figure 1.

Reflow soldering is not recommended for through-hole film capacitors. Exposing capacitors to a soldering profile in excess of the above the recommended limits may result to degradation or permanent damage to the capacitors.

Do not place the polypropylene capacitor through an adhesive curing oven to cure resin for surface mount components. Insert through-hole parts after the curing of surface mount parts. Consult KEMET to discuss the actual temperature profile in the oven, if through-hole components must pass through the adhesive curing process. A maximum two soldering cycles is recommended. Please allow time for the capacitor surface temperature to return to a normal temperature before the second soldering cycle.

Figure 1

Dielectric Film Material	Maximum Preheat Temperature			Maximum Peak Soldering Temperature	
	Capacitor Lead Spacing <10 mm	Capacitor Lead Spacing = 15 mm	Capacitor Lead Spacing >15 mm	Capacitor Lead Spacing <15 mm	Capacitor Lead Spacing >15 mm
Polyester	130°C	130°C	130°C	270°C	270°C
Polypropylene	100°C	110°C	130°C	260°C	270°C
Polyphenylene Sulphide	150°C	150°C	160°C	270°C	270°C

Wave Soldering Recommendations

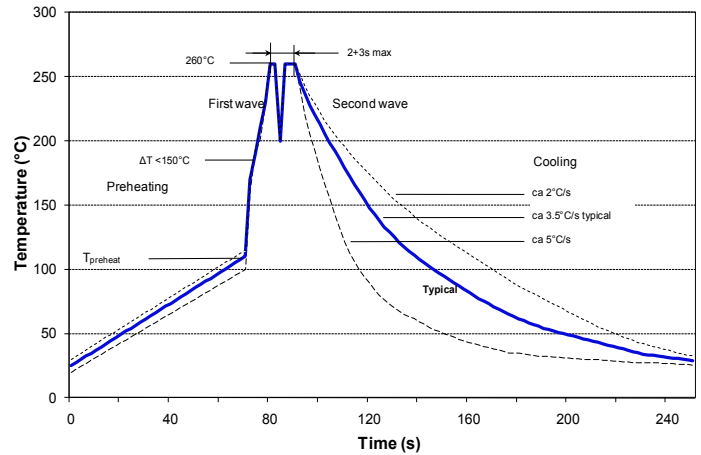

Manual Soldering Recommendations

Following is the recommendation for manual soldering with a soldering iron.

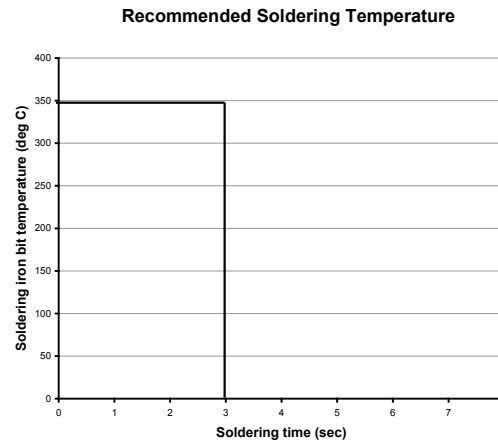

The soldering iron tip temperature should be set at 350°C (+10°C maximum) with the soldering duration not to exceed more than 3 seconds.

Soldering Process cont'd

Selective Soldering Recommendations

Selective dip soldering is a variation of reflow soldering. In this method, the printed circuit board with through-hole components to be soldered is preheated and transported over the solder bath as in normal flow soldering without touching the solder. When the board is over the bath, it is stopped and pre-designed solder pots are lifted from the bath with molten solder only at the places of the selected components, and pressed against the lower surface of the board to solder the components.

The temperature profile for selective soldering is similar to the double wave flow soldering outlined in this document, **however, instead of two baths, there is only one bath with a time from 3 to 10 seconds.** In selective soldering, the risk of overheating is greater than in double wave flow soldering, and great care must be taken so that the parts are not overheated.

Construction

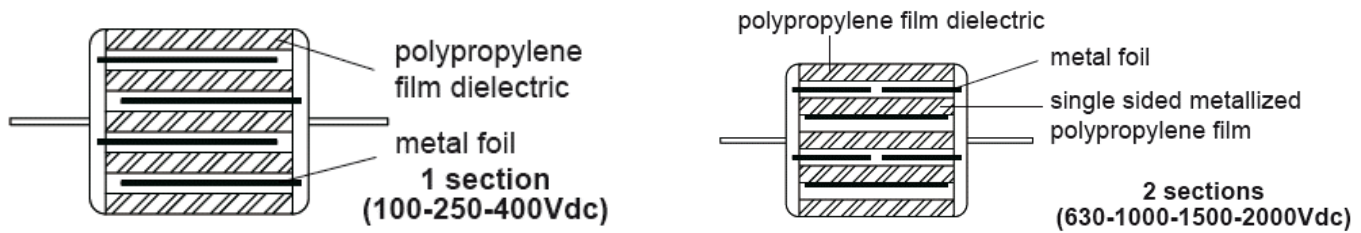

Marking

- KEMET's logo
- Series
- Dielectric code MKP
- Capacitance
- Capacitance tolerance
- Rated DC voltage

Packaging Quantities

Diameter	Length	Bulk Long Leads	Standard Reel ø 355 mm
5.0	11.0	1,500	3,000
6.5	16.5	2,000	1,200
7.0	16.5	1,750	1,100
7.5	16.5	1,500	1,000
8.0	16.5	1,250	900
8.0	20.5	1,000	900
8.0	28.0	500	900
8.5	16.5	1,000	800
8.5	20.5	750	800
8.5	28.0	500	800
9.0	16.5	1,000	800
9.0	28.0	500	800
9.5	20.5	750	600
9.5	28.0	500	600
10.0	28.0	500	600

Diameter	Length	Bulk Long Leads	Standard Reel ø 355 mm
11.0	20.5	500	400
11.0	28.0	500	400
11.5	28.0	300	400
12.5	28.0	300	400
13.0	28.0	300	400
13.5	28.0	300	300
13.5	33.0	300	300
14.0	33.0	300	300
16.0	33.0	200	250
16.5	33.0	200	250
18.0	33.0	200	200
19.0	33.0	150	150
19.5	33.0	150	150
20.0	33.0	150	150
22.5	33.0	100	–

Lead Taping & Packaging (IEC 60286-1)

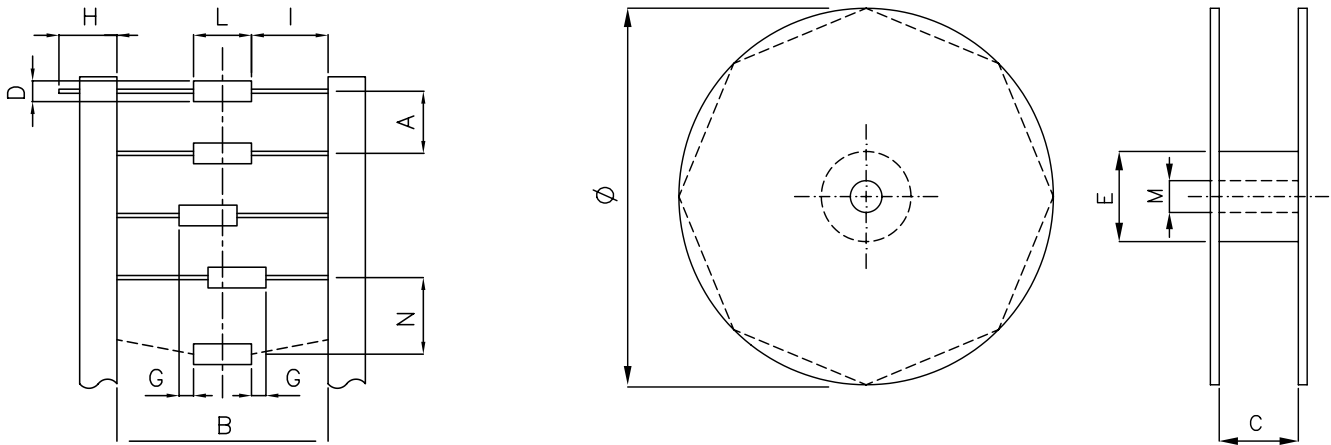

Taping Specification

Description	Symbol	Dimensions (mm)
Component diameter	D	4.5 – 19.5
Body length	L	11 – 33
Component lead spacing	A ⁽¹⁾	See Table 1
Reel core diameter	E	85
Arbor hole diameter	M	30
Reel diameter	Ø	355 maximum
Tape width	H	6 ±0.5/9 ±1 ⁽²⁾
Body location (lateral deviation)	G	≤ 0.7
Body location (longitudinal deviation)	N	≤ 1.2
Tape spacing	B	See Table 2
Lead length from the component body to the adhesive tape	I	≥ 20
Distance between reel flanges	C	See Table 2

(1) Maximum cumulative feed hole error 1.5 mm per 6 parts.

(2) 9 ±1 for capacitor with L ≥ 31.5.

Table 1

Dimensions in mm	
Diameter	A
≤ 5	5 ±0.5
5.1 – 9.5	10 ±0.5
9.6 – 14.7	15 ±0.5
14.8 – 19.5	20 ±1.0

Table 2

Dimensions in mm			
Length	Class	B ^{±1.5}	C
≤ 11	I	52.4	75
14 – 20.5	II	63.6	86
≥ 26	III	73	98

KEMET Corporation World Headquarters

2835 KEMET Way
Simpsonville, SC 29681

Mailing Address:
P.O. Box 5928
Greenville, SC 29606

www.kemet.com
Tel: 864-963-6300
Fax: 864-963-6521

Corporate Offices
Fort Lauderdale, FL
Tel: 954-766-2800

North America

Southeast
Lake Mary, FL
Tel: 407-855-8886

Northeast
Wilmington, MA
Tel: 978-658-1663

Central
Novi, MI
Tel: 248-306-9353

West
Milpitas, CA
Tel: 408-433-9950

Mexico
Guadalajara, Jalisco
Tel: 52-33-3123-2141

Europe

Southern Europe
Paris, France
Tel: 33-1-4646-1006

Sasso Marconi, Italy
Tel: 39-051-939111

Central Europe
Landsberg, Germany
Tel: 49-8191-3350800

Kamen, Germany
Tel: 49-2307-438110

Northern Europe
Bishop's Stortford, United Kingdom
Tel: 44-1279-460122

Espoo, Finland
Tel: 358-9-5406-5000

Asia

Northeast Asia
Hong Kong
Tel: 852-2305-1168

Shenzhen, China
Tel: 86-755-2518-1306

Beijing, China
Tel: 86-10-5829-1711

Shanghai, China
Tel: 86-21-6447-0707

Taipei, Taiwan
Tel: 886-2-27528585

Southeast Asia
Singapore
Tel: 65-6586-1900

Penang, Malaysia
Tel: 60-4-6430200

Bangalore, India
Tel: 91-806-53-76817

Note: KEMET reserves the right to modify minor details of internal and external construction at any time in the interest of product improvement. KEMET does not assume any responsibility for infringement that might result from the use of KEMET Capacitors in potential circuit designs. KEMET is a registered trademark of KEMET Electronics Corporation.

Disclaimer

All product specifications, statements, information and data (collectively, the "Information") in this datasheet are subject to change. The customer is responsible for checking and verifying the extent to which the Information contained in this publication is applicable to an order at the time the order is placed.

All Information given herein is believed to be accurate and reliable, but it is presented without guarantee, warranty, or responsibility of any kind, expressed or implied.

Statements of suitability for certain applications are based on KEMET Electronics Corporation's ("KEMET") knowledge of typical operating conditions for such applications, but are not intended to constitute – and KEMET specifically disclaims – any warranty concerning suitability for a specific customer application or use. The Information is intended for use only by customers who have the requisite experience and capability to determine the correct products for their application. Any technical advice inferred from this Information or otherwise provided by KEMET with reference to the use of KEMET's products is given gratis, and KEMET assumes no obligation or liability for the advice given or results obtained.

Although KEMET designs and manufactures its products to the most stringent quality and safety standards, given the current state of the art, isolated component failures may still occur. Accordingly, customer applications which require a high degree of reliability or safety should employ suitable designs or other safeguards (such as installation of protective circuitry or redundancies) in order to ensure that the failure of an electrical component does not result in a risk of personal injury or property damage.

Although all product-related warnings, cautions and notes must be observed, the customer should not assume that all safety measures are indicated or that other measures may not be required.

X-ON Electronics

Largest Supplier of Electrical and Electronic Components

Click to view similar products for [Film Capacitors](#) category:

Click to view products by [Kemet](#) manufacturer:

Other Similar products are found below :

[F339X134748MIP2T0](#) [F450KG153J250ALH0J](#) [750-1018](#) [FKP1-1500160010P15](#) [FKP1R031007D00JYSD](#) [FKP1R031507E00JYSD](#)
[FKP1U024707E00KYSD](#) [82DC4100CK60J](#) [82EC1100DQ50K](#) [PFR5101J100J11L16.5TA18](#) [PME261JB5220KR19T0](#) [A451GK223M040A](#)
[A561ED221M450A](#) [QXJ2E474KTPT](#) [QXL2B333KTPT](#) [R49AN347000A1K](#) [EEC2G505HQA406](#) [B25668A6676A375](#) [B25673A4282E140](#)
[BFC233868148](#) [BFC2370GC222](#) [C3B2AD44400B20K](#) [C4ASWBU3220A3EK](#) [CB027C0473J--](#) [CB177I0184J--](#) [CB182K0184J--](#) [23PW210](#)
[950CQW5H-F](#) [SBDC3470AA10J](#) [SCD105K122A3-22](#) [2N3155](#) [A571EH331M450A](#) [FKP1-2202KV5P15](#) [FKS3-680040010P10](#)
[QXL2E473KTPT](#) [445450-1](#) [B25669A3996J375](#) [46KI322000M1M](#) [46KR415050M1K](#) [4BSNBX4100ZBFJ](#) [MKP383510063JKP2T0](#)
[MKPY2-.02230020P15](#) [MKT 1813-368-015](#) [4055292001](#) [46KN410000N1K](#) [EEC2E106HQA405](#) [EEC2G205HQA402](#) [EEC2G805HQA415](#)
[P409CP224M250AH470](#) [82EC2150DQ50K](#)