

Type VR Vertical Mounting Clamp



Diameter of Part to be Mounted	Catalog Part Number			Dimensions		
	Without Screw & Nut	Unassembled Screw & Nut Included	Assembled with Screw & Nut	A	B	C
1" to 1-1/16	VR1B	VR1	VR1A	1"	1-7/16"	1-7/8"
1-3/8" to 1-7/16	VR3B	VR3	VR3A	1-3/8"	1-25/32"	2-7/32"
1-1/2" to 1-9/16	VR4B	VR4	VR4A	1-1/2"	1-15/16"	2-11/32"
1-3/4" to 1-13/16	VR6B	VR6	VR6A	1-3/4"	2-1/4"	2-9/16"
2" to 2-1/16	VR8B	VR8	VR8A	2"	2-1/2"	2-13/16"
2-1/2" to 2-9/16	VR10B	VR10	VR10A	2-1/2"	3"	3-5/16"
3" to 3-1/8	VR12B	VR12	VR12A	3"	3-7/16"	3-13/16"
Screw	VRSCREW	—	—	9/16" long 6-32 thread NC-2A		
Nut	VRNUT	—	—	Standard hex nut to fit screws		

CDE VR mounting clamps may be used to mount any cylindrical capacitor with a 1" to 3" diameter that is to be mounted in a vertical position. Material is 1010 CRS, commercial grade #4 temper ASI scale. Parts are finished with .0001 (nominal) zinc chromate plating. Use for mounting CG types, PSU, SF and MPF types. Material thickness is .035"



Type TH Horizontal Mounting Clip



Catalog Part Number	Dimensions in Inches		
	Nominal Dia. of Part to be Mounted	A	B
TH13	.375	.250	.47
TH17	.625	.312	.72
TH21	.875	.312	1.00
TH23	1.000	.312	1.06
TH25	1.375	.312	1.50

These clips, though designed for capacitors, have varied applications to retain many cylindrical components. They are used extensively in the electrical and electronic industries to hold spindles, condensers, capacitors, tubes, rods and conduit. Clips have phosphate and oil finish.

Material thickness TH13 thru TH17 is .016". TH21 thru TH25 is .020"

ACR15KT Motor Start Resistor Kit



15K Ohm 2 watt bleeder resistors for AC motor start applications. Saves relay switch contacts and capacitor, particularly in capacitor start applications. 1/4" quick connect terminals eliminate need for soldering.

ACR15K:

Pack of 10, 15K Ohm 2 watt bleeder resistor without quick connect terminals.

ACR220KT Motor Run Resistor Kit



220K Ohm 1 watt bleeder resistors for AC motor run applications. Saves relay switch contacts and capacitor, particularly in capacitor run applications. 1/4" quick connect terminals eliminate need for soldering.

ACR220K:

Pack of 10, 220K Ohm 1 watt bleeder resistor without quick connect terminals.

Capacitor Hardware

Oval Capacitor Hardware

Mounting Brackets #32107

Case Code	Bracket
A	32107-1
C	32107-2
D	32107-3



End Mount Footed Bracket (2 required) #30434

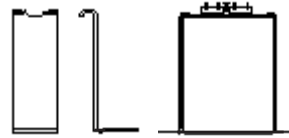

Side Mount Footed Bracket (2 required) #31762

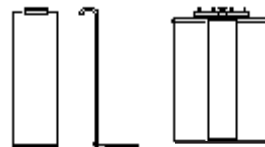

H (Inches)	End Mount	Side Mount
2.13	30434-33	31762-45
2.38	30434-37	31762-46
2.63	30434-41	31762-47
2.88	30434-45	31762-48
3.13	30434-49	31762-49
3.50	30434-55	31762-50
3.75	30434-59	31762-83
3.88	30434-61	31762-51
4.25	30434-67	31762-52
4.75	30434-75	31762-54
5.13	30434-81	31762-132
5.25	30434-83	31762-55
5.75	30434-91	31762-56
6.25	30434-99	31762-59
6.75	30434-107	31762-60
7.25	30434-115	31762-62
8.00	30434-127	31762-63
9.00	30434-143	31762-78

Insulating Terminal Boots UL Approved Material

44603

32108-2

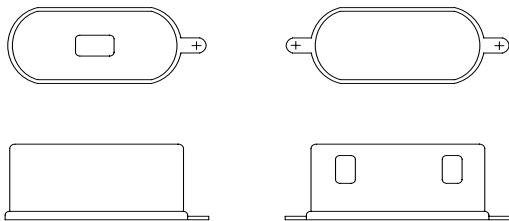

Wrap Around Bracket

Case Code	Bracket
A	30393-5
C	30393-9
D	OB3

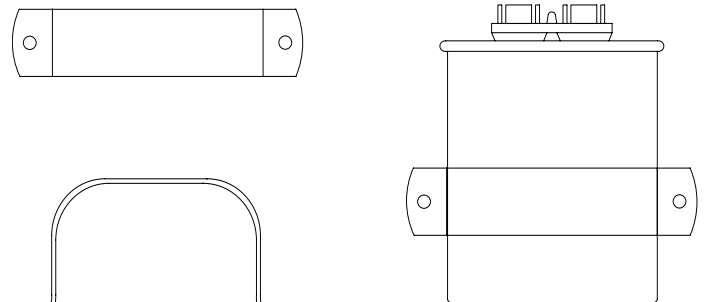

Round Capacitor Hardware

3 Footed Round Mounting Bracket

Case Code	Bracket
P	VR6B
S	VR8B
T	VR10B

2 Footed Round Mounting Bracket

Case Code	Bracket
P	32107-6
S	32107-7
T	32107-8

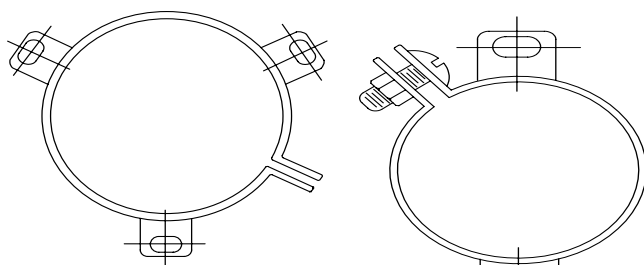

Motor Start Mounting Hardware

Bracket



End Cap

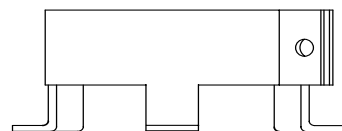
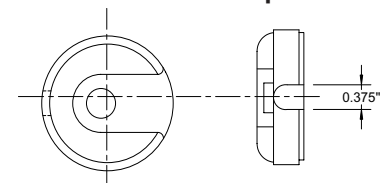

Wrap Around Bracket

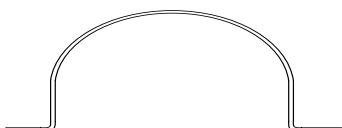

Case Code	Bracket
P	RB175
S	RB200
T	RB250

Case Code	Case Dimensions (Inches)		Down Wire Cap	Up Wire Cap	Optional Mounting Bracket
	D	L			
1	1.438	2.750	PL3	PLA3	HB2
2	1.438	3.375	PL3	PLA3	HB4
3	1.438	4.375	PL3	PLA3	HB8
4	1.813	3.375	PL6	PLA6	HB4
5	1.813	4.375	PL6	PLA6	HB8
6	2.063	3.375	PL8	PLA8	HB4
7	2.063	4.375	PL8	PLA8	HB8
8	2.563	4.375	PL10	PLA10	HB8

Order both endcap and bracket for mounting

Screw-Terminal, Computer-Grade Capacitor, Mounting Hardware

FIGURE 1



FIGURE 2



FIGURE 3



FIGURE 4

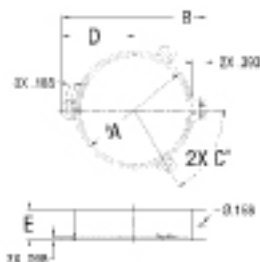

Clamp Dimensions

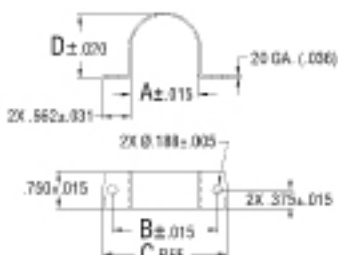

Clamp Number	Dimensions in Inches			
	A	B	C	C
125562-01	1.375	2.125	2.500	1.281
125562-05	1.750	2.500	2.875	1.656
125562-02	2.000	2.750	3.125	1.906
125562-04	2.500	3.250	3.625	2.406
125562-03	3.000	3.750	4.125	2.906
125562-06	3.500	4.250	4.625	3.481

Bracket Dimensions

Figure	Bracket Number	Dimensions in Inches						Dimensions in Millimeters					
		A	B	C	D	E	F	A	B	C	D	E	F
1	125565-06*	1.375	1.813	30 °	2.313	.750	.563	34.93	46.04	30°	58.74	19.05	14.30
1	125565-15*	1.750	2.188	30 °	2.625	.750	.560	44.45	55.56	30°	66.68	19.05	14.22
2	125565-09*	2.000	1.250	75 °	1.438	1.125	.750	50.80	31.75	75°	36.51	28.58	19.05
3	125565-05	2.000	2.563	30 °	2.938	1.125	.750	50.80	65.09	30°	76.41	28.58	19.05
2	125565-14*	2.500	1.500	75 °	1.688	1.125	.750	63.50	38.10	75°	42.86	28.58	19.05
3	125565-10	2.500	3.000	30 °	3.438	1.125	.750	63.50	76.20	30°	87.31	28.58	19.05
2	125565-11*	3.000	1.750	75 °	1.938	1.125	.750	76.20	44.45	75°	49.21	28.58	19.05
3	125565-01	3.000	3.500	30 °	3.938	1.125	.750	76.20	88.90	30°	100.01	28.58	19.05
4	125309-01	3.500	4.488	60 °	2.224	.984	—	90.00	114.00	60°	4.70	25.00	—

Note: All mounting brackets and clamps except Figure 4 are zinc plated. Figure 4 is a black nylon. When mounting capacitors there is no need to wrap capacitors with protective wrapping before installing mounting clamp.

*Stock bracket

Nylon Nuts for Insulated Stud Mounting



Nylon Nut Part Number	For Stud Diameter (mm)	Standoff Diameter S (mm)	Nut Diameter W (mm)	Nut Elevation T (mm)	Hex Head J (mm)	Mounting		
						Min. Hole Diameter (mm)	Max. Chassis Thickness (mm)	Max. Tightening Torque in. lbs.
M8S17W25	M8	17	25	14	17	17.5	5	25
M12S22W30	M12	22	30	16	19	22.5	5	75
M12S30W38	M12	30	38	16.5	19	30.5	5	75

X-ON Electronics

Largest Supplier of Electrical and Electronic Components

Click to view similar products for [Capacitor Hardware](#) category:

Click to view products by [Cornell Dubilier](#) manufacturer:

Other Similar products are found below :

[FN380-4-](#) [124586 0035A](#) [B44020B0002B030](#) [B44020J0006B012](#) [B44020J0007B012](#) [26230-374](#) [SG12000P](#) [FN322-3-05](#) [FN380-2-](#) [FN386-](#)
[2-](#) [FN389B-2-](#) [PYR7511-27](#) [300-100-075](#) [31762-87](#) [MAL804324051E3](#) [B44020A0002B025](#) [B44030J0051B000](#) [B44030J0064B000](#)
[B44030J0090B000](#) [31762-45](#) [340-400](#) [3897](#) [4586-48](#) [432703040301](#) [B44020B0001B025](#) [B44030A0051B000](#) [B44030A0036B000](#) [TT-100](#)
[372-400](#) [HE3BKT003](#) [M8S17W25](#) [TT-500](#) [2353](#) [2788](#) [375-500](#) [124586-0026A](#) [355-700](#) [009382E](#) [307-500](#) [31762-132](#) [32107-3](#) [4586-97A](#)
[125562-03](#) [VR1](#) [VR1B](#) [VR3B](#) [TT-900](#) [RB200](#) [VR6B](#) [VR6A](#)