

## Permanent magnet stepper motors, 7.5°-18°, types SP0618 - SP5575



### Option



### Pin configuration

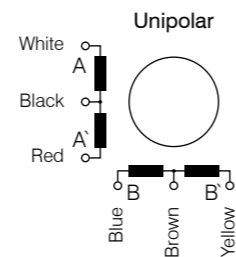
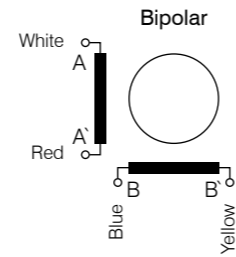

### Order identifier

**SP(G) 3575 S 0506 -A**  
 A = one shaft end

- with molded-on plug
- with high-quality plain bearings on both sides

Thanks to the simple construction, SP permanent magnet motors are suitable for low-cost device applications where larger step angles suffice. The SPG variants have an integrated gear with a reduction ratio from 50 or 102.

### Available versions (other version of winding, shaft and flange on request)

Type	Step Resolution °	Current per winding A/winding	Voltage per winding V/winding	Holding torque N cm	Resistance per winding Ohm/winding	Inductance per winding mH/winding	Rotor inertia torque g cm <sup>2</sup>	Weight kg	Dia meter (mm)
SP0618M0204	18°	0.250	3.0	0.045	12.0	10.00	0.002	0.002	6
SP0818M0204	18°	0.238	5.0	0.059	21.0	1.37	0.002	0.003	8
SP1018M0204	18°	0.220	3.3	0.160	15.0	3.00	0.010	0.004	10
SP1518M0104	18°	0.065	12.0	0.320	190.0	37.00	1.000	0.012	15
SP1518M0204	18°	0.24	12.0	0.350	50.0	9.00	1.000	0.012	15
SPG1518M0504-50	0.36°	0.50	5.0	13.500	10.0	2.30	1.000	0.012	15
SPG1518M0504-102	0.176°	0.50	5.0	20.000	10.0	2.30	1.000	0.012	15
SP2018M0506	18°	0.500	5.0	0.500	10.0	1.85	1.000	0.026	20
SP2515M0406	15°	0.430	5.0	1.000	11.5	2.30	1.000	0.036	25
SP2575M0206	7.5°	0.240	12.0	1.600	50.0	12.00	1.000	0.036	25
SP2575M0506	7.5°	0.500	5.0	1.400	10.0	2.00	1.000	0.036	25
SP2575M0704	7.5°	0.760	3.8	1.000	5.0	3.00	1.000	0.036	25
SP3575S0506	7.5°	0.500	5.0	4.000	10.0	3.80	5.000	0.090	35
SP3575M0906	7.5°	0.860	5.0	5.500	5.8	6.50	7.500	0.090	35
SP4275S0606	7.5°	0.590	5.0	5.000	8.6	4.50	9.600	0.110	42
SP4275M0806	7.5°	0.810	5.0	6.000	6.2	5.50	9.600	0.130	42
SP5575M0106	7.5°	0.120	12.0	15.000	100.0	107.00	12.500	0.270	57
SP5575M0604	7.5°	0.625	5.6	12.000	9.0	19.50	12.500	0.270	57

All data refer to 1 half of the winding or unipolar!

### Speed/torque curves

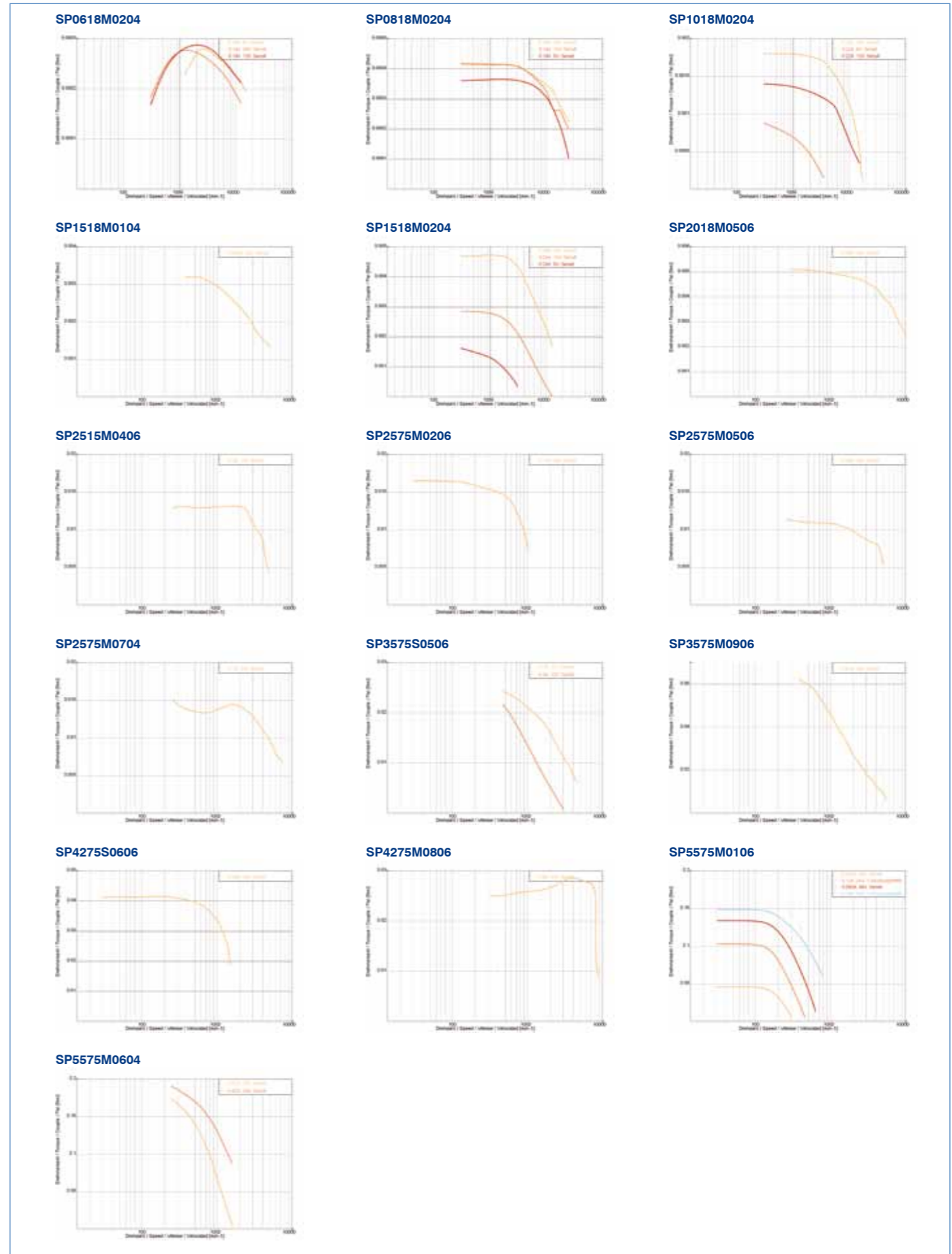

## Permanent magnet stepper motors, 7.5°-18°, types SP0618 - SP5575

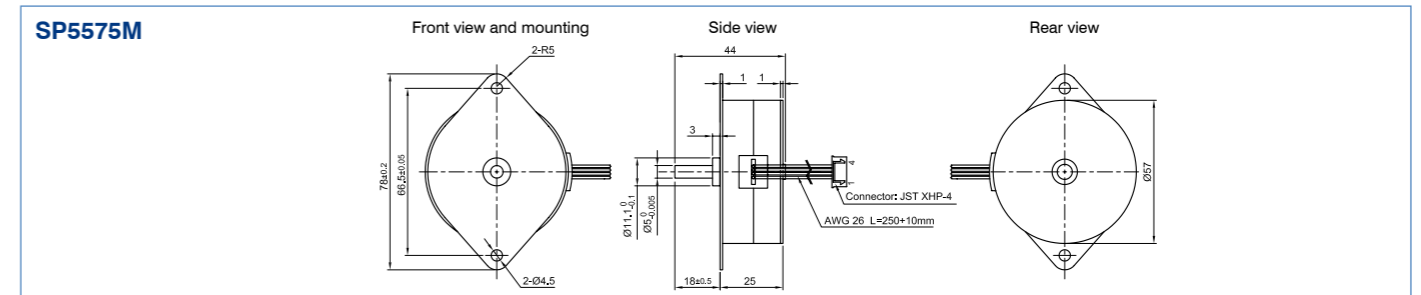
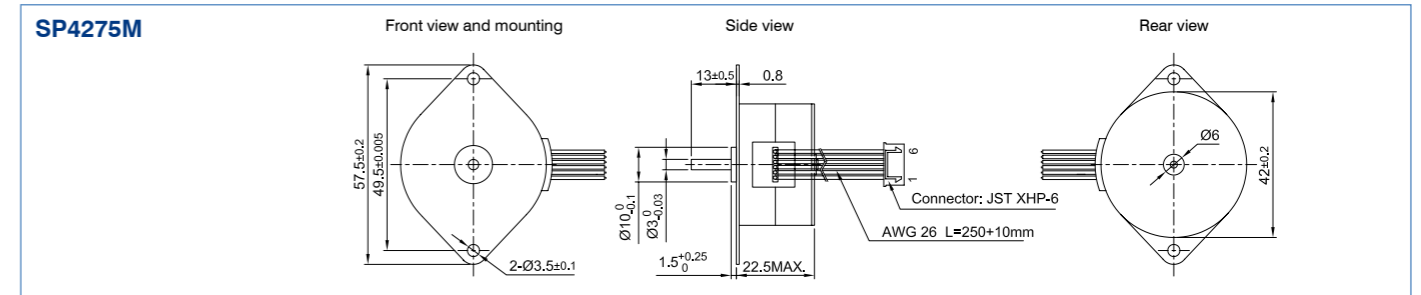
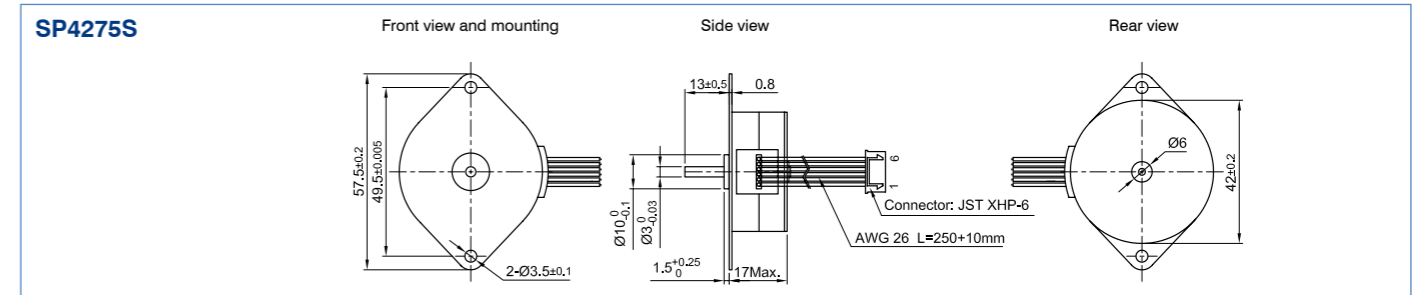
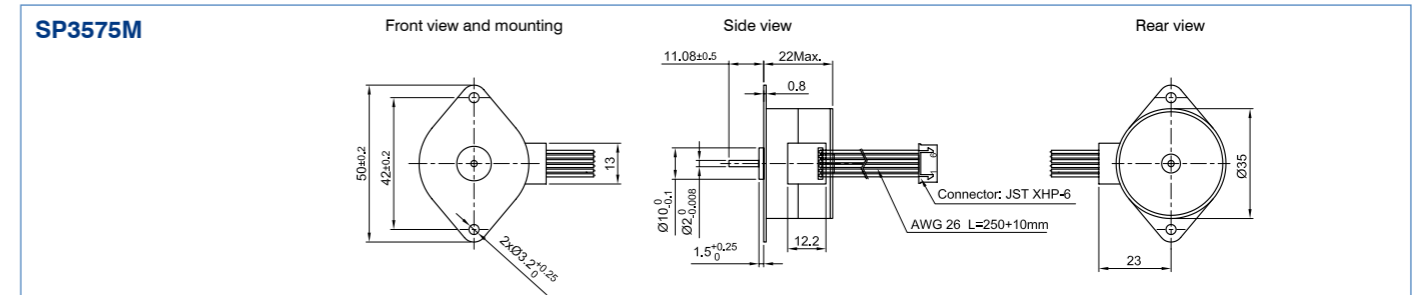
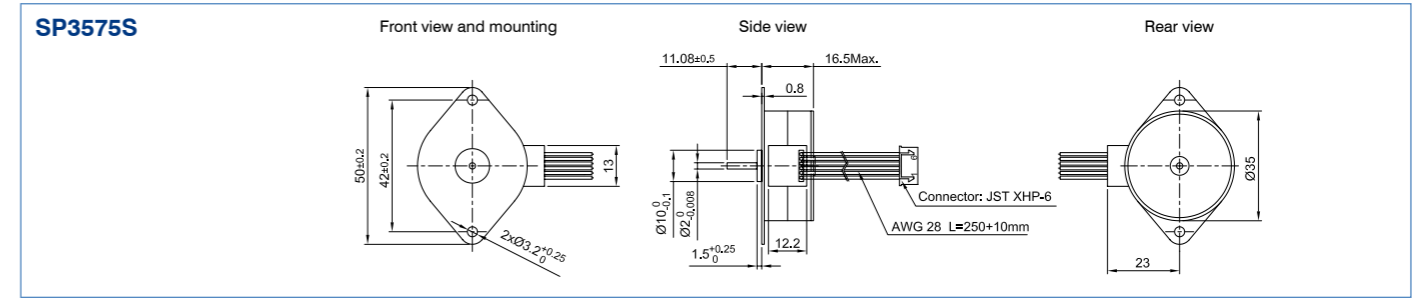
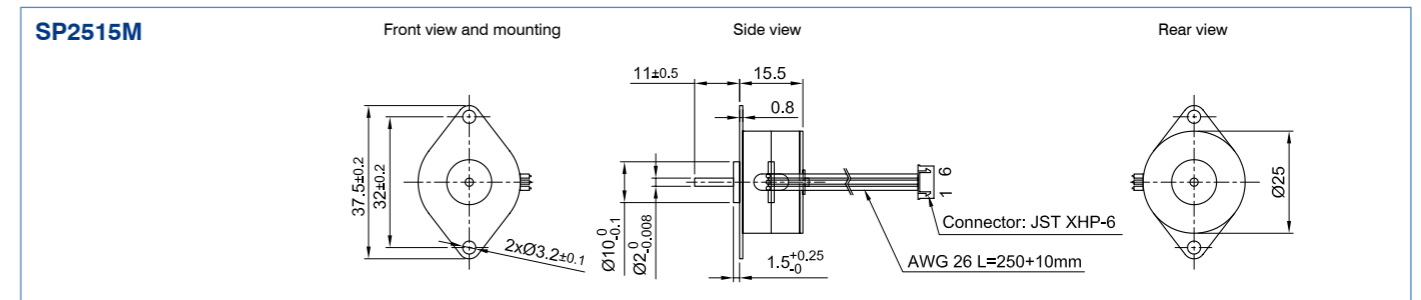
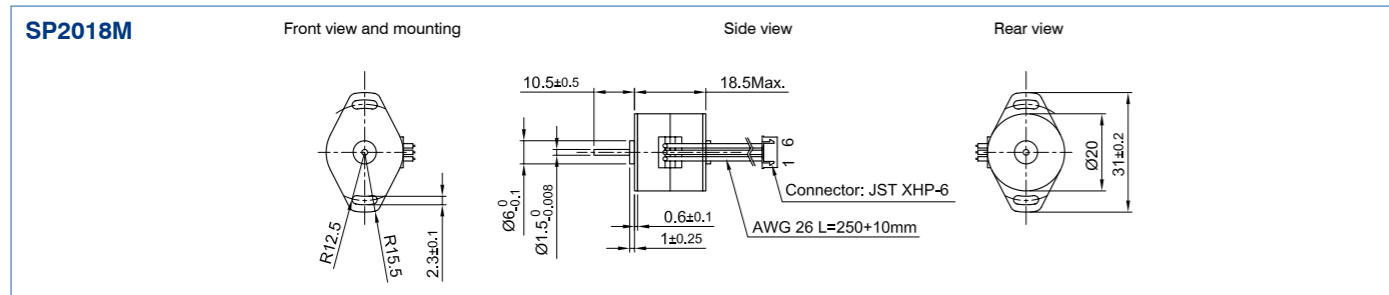
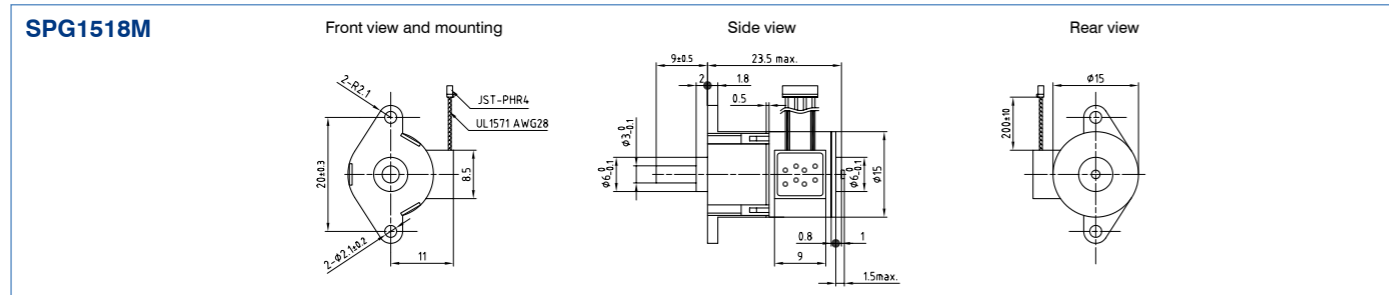
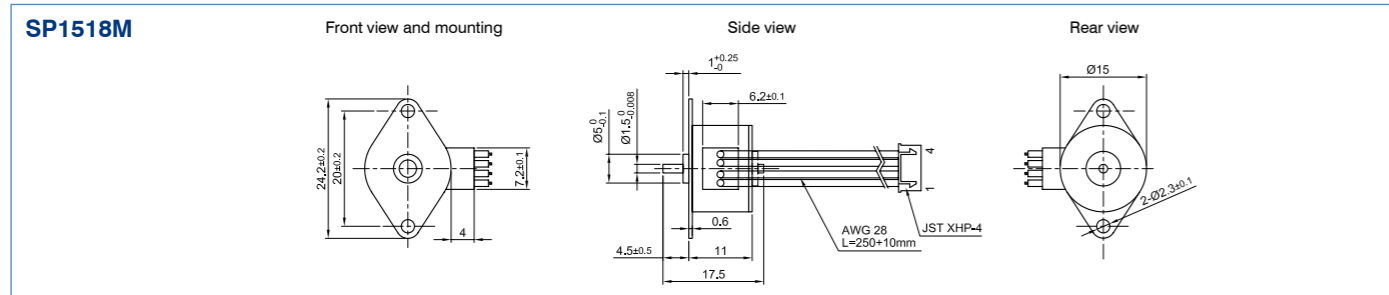
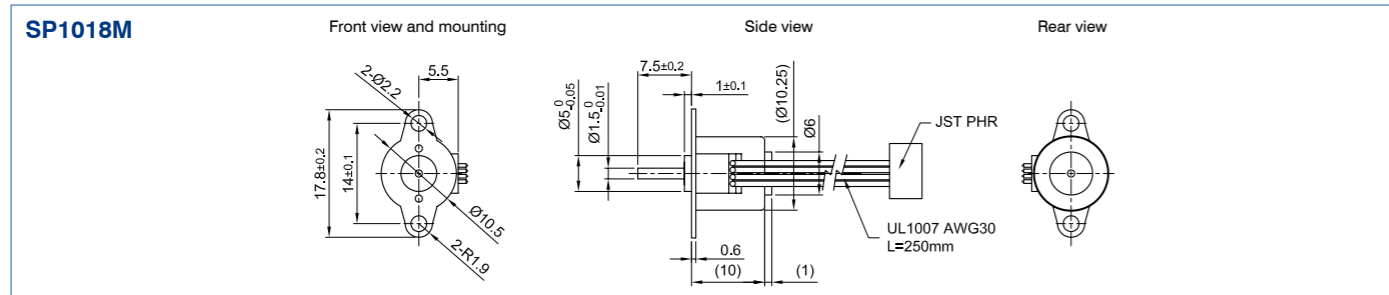
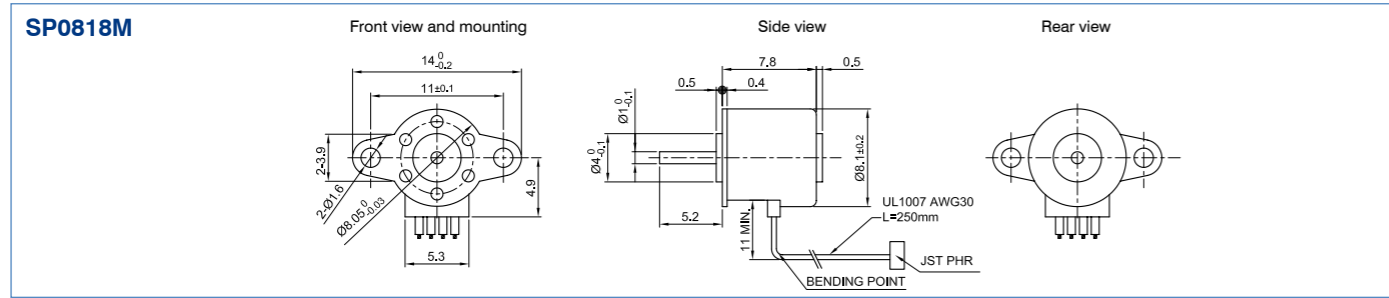
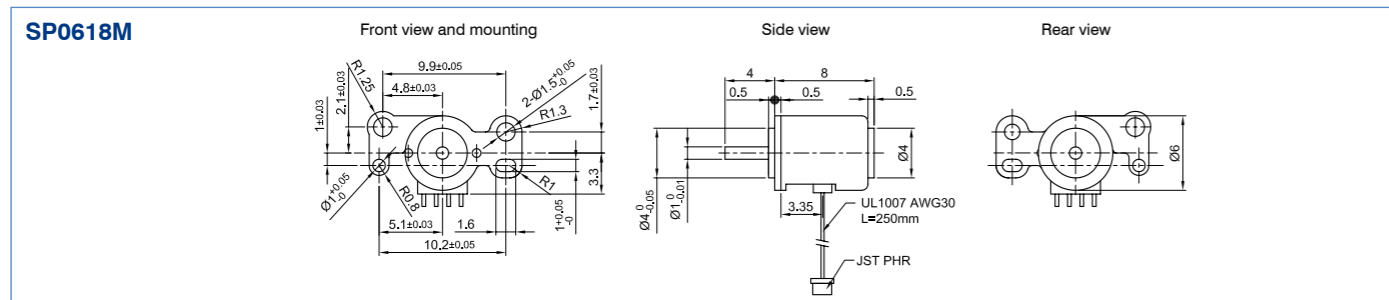

## **X-ON Electronics**

Largest Supplier of Electrical and Electronic Components

*Click to view similar products for [nanotec](#) manufacturer:*

Other Similar products are found below :

[LSNUT-T6X2-F](#) [STF2818X0504-A](#) [SP2575M0206-A](#) [C5-01](#) [DB59C024035-A](#) [SP1518M0204-A](#) [ST6018L3008-A](#) [ZKRS485-USB](#)  
[SP3575M0906-A](#) [ST2818S1006-B](#) [ST4118L1804-A](#) [SMCI35](#)