

# VMMK-1218

## 0.5 to 18 GHz Low Noise E-PHEMT in a Wafer Scale Package



### Data Sheet



#### Description

Avago Technologies has combined its industry leading E-pHEMT technology with a revolutionary chip scale package. The VMMK-1218 can produce an LNA with high dynamic range, high gain and low noise figure that generates off of a single position DC power supply. The GaAsCap wafer scale sub-miniature leadless package is small and ultra thin, yet can be handled and placed with standard 0402 pick and place assembly.

The use of 0.25 micron gates allow a ultra low noise figure (below 1dB from 500 MHz to 12 GHz) with respectable associated gain. With a flat transconductance over bias and frequency the VMMK-1218 provides excellent linearity of over 30 dBm and power over 15 dBm at one dB compression. This product is easy to use since it requires only positive DC voltages for bias and low matching coefficients for simple impedance matching to 50 Ω systems.

The VMMK-1218 is intended for any 500MHz to 18GHz application including 802.11abgn WLAN, WiMax, BWA 802.16 & 802.20 and military applications.

#### WLP 0402, 1mm x 0.5mm x 0.25 mm

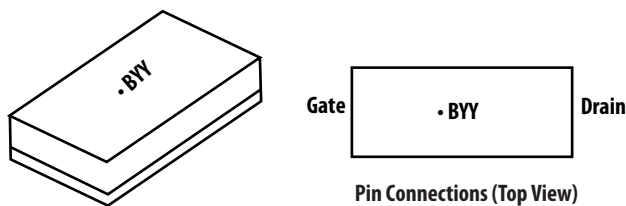

Pin Connections (Top View)

Notes: Top view package marking provides orientation

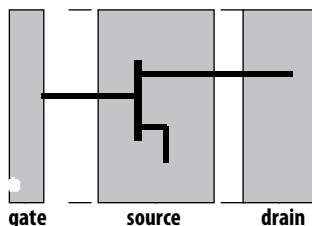

Notes:  
"b" = Device Code  
"YY" = Year Code

#### Features

- Sub-miniature 0402 (1mm x 0.5mm) Surface Mount Leadless Package
- Low height (0.25mm)
- Frequency Range 0.5 to 18 GHz
- Enhancement Mode [1]
- 0.25 micron gate width
- Tape and Reel packaging option available
- Point MTTF > 300 years at 120°C channel temperature

#### Specifications

- 0.7 dB Fmin
- 9.0 dB Ga
- +22 dBm output 3<sup>rd</sup> order intercept
- +12 dBm output power

#### Applications

- Low Noise and Driver for Cellular/PCS and WCDMA Base Stations
- 2.4 GHz, 3.5GHz, 5-6GHz WLAN and WiMax notebook computer, access point and mobile wireless applications
- DBS 10 to 13 GHz receivers
- VSAT and SATCOM 13 to 18 GHz systems
- 802.16 & 802.20 BWA systems
- WLL and MMDS Transceivers
- General purpose discrete E-pHEMT for other ultra low noise applications

Notes:

1. The Avago enhancement mode pHEMT devices do not require a negative gate bias voltage as they are "normally off". They can help simplify the design and reduce the cost of receivers and transmitters in many applications from 500 MHz to 18 GHz



**Attention: Observe precautions for handling electrostatic sensitive devices.**

ESD Machine Model = 20 V (class A)

ESD Human Body Model = 100 V (Class 0)

Refer to Avago Application Note A004R:

*Electrostatic Discharge, Damage and Control.*

## VMMK-1218 Absolute Maximum Ratings

Sym	Parameters/Condition	Unit	Max
Vds	Drain-Source Voltage <sup>[2]</sup>	V	5
Vgs	Gate-Source Voltage <sup>[2]</sup>	V	-5 to 1
Vgd	Gate-Drain Voltage <sup>[2]</sup>	V	-5 to 1
Ids	Drain Current <sup>[2]</sup>	mA	100
Igs	Gate Current	mA	1.6
Pdn	Total Power Dissipation <sup>[3]</sup>	mW	300
Pin	RF CW Input Power Max	dBm	10
Tch	Max channel temperature	C	+150
$\theta_{jc}$	Thermal Resistance <sup>[4]</sup>	C/W	200

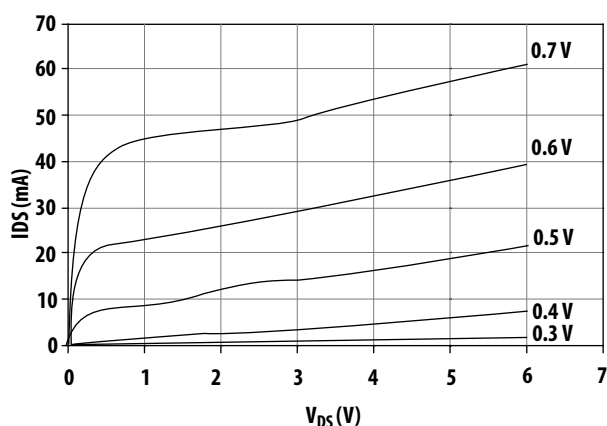

Figure 1. Typical I-V Curves. (VGS=0.1 V per step)

### Notes:

1. Operation in excess of any of these conditions may result in permanent damage to this device.
2. Assumes DC quiescent conditions
3. Ambient operational temperature  $T_A=25^\circ\text{C}$  unless noted.
4. Thermal resistance measured using  $150^\circ\text{C}$  Liquid Crystal Measurement Method
5. The device can handle +10dBm RF input power provided  $I_{gs}$  is limited to 1mA

## VMMK-1218 RF Specifications (on board) <sup>[6,7]</sup>

$T_A = 25^\circ\text{C}$ , Freq = 10 GHz, Vds = 3V, Ids = 20mA,  $Z_o = 50 \Omega$  (unless otherwise specified)

Sym	Parameters/Condition	Units	Min	Typ.	Max
Vgs	Gate Voltage	V	0.48	0.58	0.68
Igs	Gate Current	uA		0.4	
Gm	Transconductance	mS		200	
Ga	Associated Gain	dB	6.7	9	10.2
NF	Noise Figure	dB		0.81	1.5
Fmin	Noise Figure min	dB		0.71	
P-1dB	1dB Compressed Output Power	dBm		+12	
OIP3	Output 3 <sup>rd</sup> Order Intercept Point	dBm		+22	

### Notes:

6. Specifications are derived from measurements in a test circuit.
7. All tested parameters guaranteed with measurement accuracy  $\pm 0.5\text{dB}$  for gain.

## Product Consistency Distribution Charts [1]

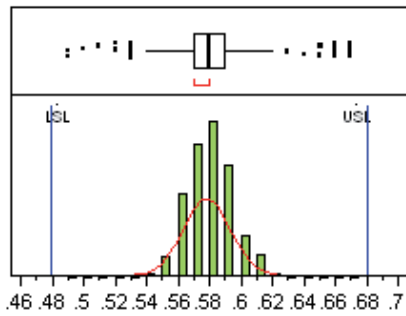

Figure 2. Gate Voltage @  $V_{ds} = 3V$  &  $I_{ds} = 20mA$ , LSL=0.48, Nominal=0.58, USL=0.68, CPK=2.2

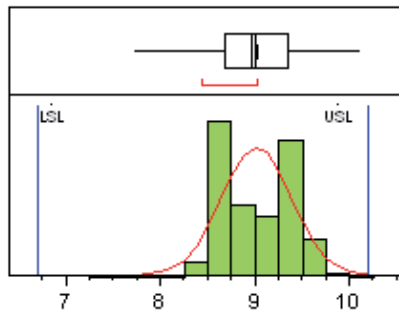

Figure 3. Gain @ 10 GHz, LSL=6.7, Nominal=9.0, USL=10.2, CPK=1.1

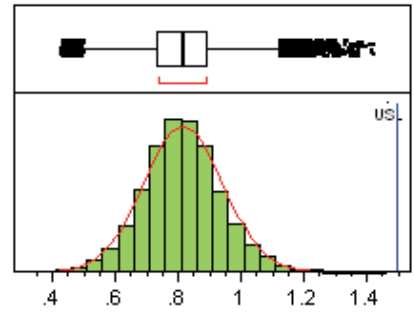

Figure 4. NF @ 10 GHz, Nominal=0.81, USL=1.50, CPK=1.8

Note:

1. Distribution data based at least 500 part sample size from two wafers during initial characterization of this product. Future wafers allocated to this product may have nominal values anywhere between upper and lower limits.

## VMMK-1218 Typical Performance Curve

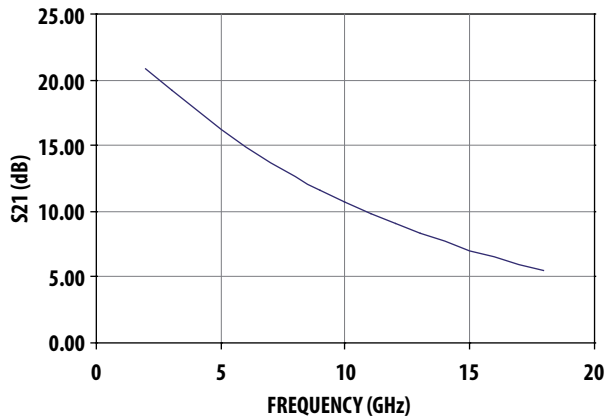

Figure 5. S21 vs. Frequency at 2V, 20mA

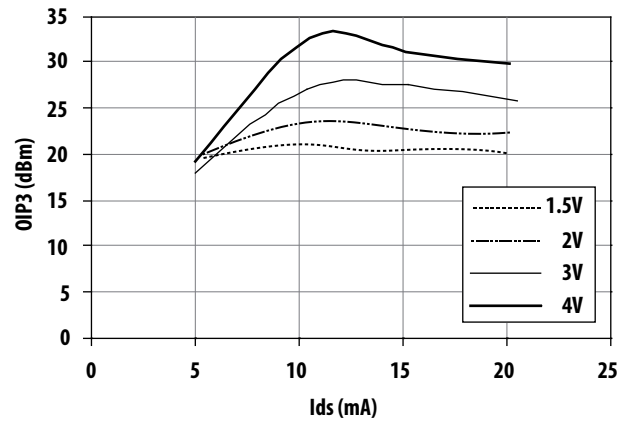

Figure 6. OIP3 vs.  $I_{ds}$  at 10 GHz ( $Z_i = Z_o = 50\Omega$ )

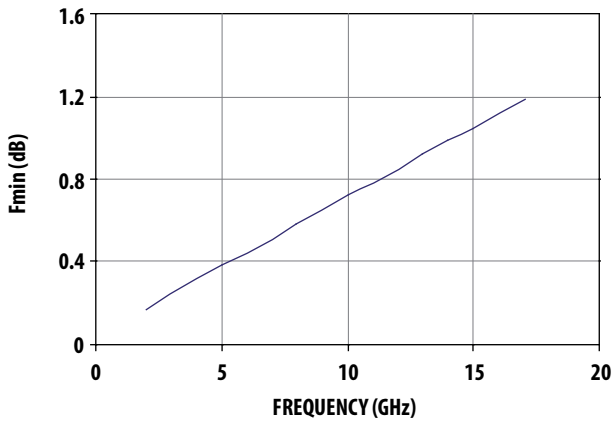

Figure 7. Fmin vs. Frequency at 2V, 20mA

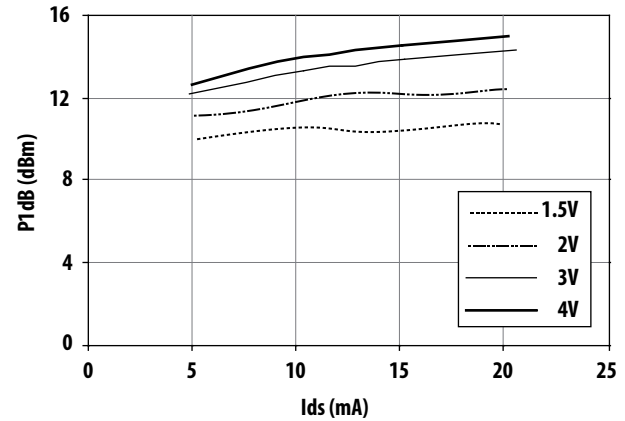

Figure 8. P1dB vs.  $I_{ds}$  at 10 GHz ( $Z_i = Z_o = 50\Omega$ )

### VMMK-1218 Typical Performance Curve

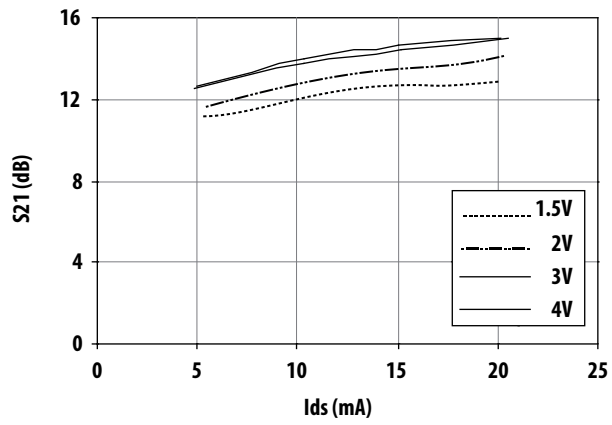

Figure 9. Gain vs. Ids at 10 GHz

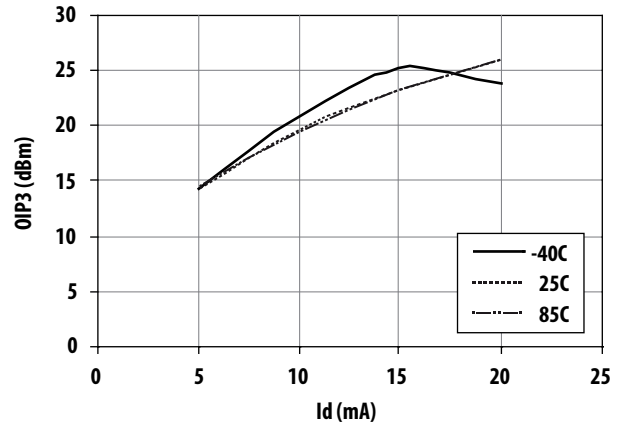

Figure 10. OIP3 vs. Ids at 2V over temperature at 10 GHz

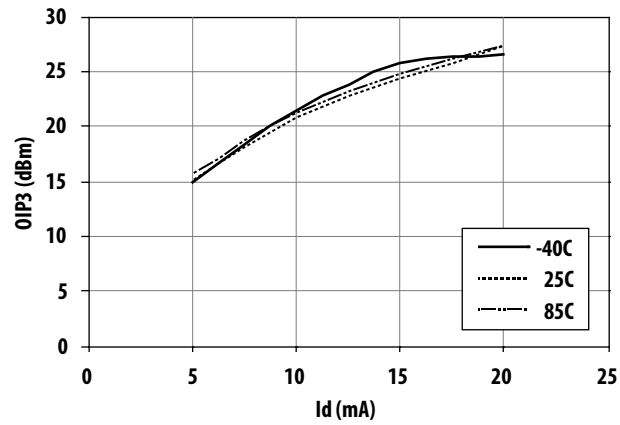

Figure 11. OIP3 vs. Ids at 3V over temperature at 10 GHz

**VMMK-1218 Typical Scattering Parameters and Noise Parameters,  $T_A=25^\circ\text{C}$ ,  $V_{ds}=2\text{V}$ ,  $I_{ds}=20\text{mA}$  [1]**

Freq GHz	S11			S21		S12		S22		MSG/MAG
	Mag.	Ang.	dB	Mag.	Ang.	Mag.	Ang.	Mag.	Ang.	dB
2	0.89	-78.16	20.92	11.12	129.71	0.06	44.50	0.54	-55.65	29.35
3	0.85	-106.33	19.31	9.23	112.05	0.07	29.40	0.47	-76.55	25.87
4	0.81	-128.95	17.70	7.68	97.65	0.08	17.41	0.41	-94.12	23.11
5	0.79	-146.66	16.25	6.49	85.78	0.08	7.80	0.37	-108.21	21.15
6	0.78	-161.38	14.93	5.58	75.40	0.09	-0.22	0.34	-120.69	19.57
7	0.78	-173.77	13.74	4.86	66.04	0.09	-7.10	0.32	-131.78	18.21
8	0.77	175.63	12.65	4.29	57.40	0.09	-13.35	0.31	-141.77	17.06
9	0.77	166.49	11.64	3.82	49.36	0.09	-18.82	0.31	-151.17	16.03
10	0.78	158.16	10.71	3.43	41.75	0.08	-24.10	0.30	-159.09	15.12
11	0.78	150.76	9.87	3.12	34.59	0.08	-28.99	0.31	-166.30	14.31
12	0.78	143.93	9.09	2.85	27.60	0.08	-33.20	0.31	-173.04	13.61
13	0.78	137.52	8.38	2.62	20.89	0.08	-37.50	0.32	-179.45	12.97
14	0.79	131.39	7.71	2.43	14.43	0.08	-41.46	0.32	-174.80	12.39
15	0.79	125.61	7.11	2.27	8.03	0.08	-45.30	0.33	-169.68	11.86
16	0.79	119.69	6.53	2.12	1.59	0.07	-49.20	0.34	-164.86	11.37
17	0.80	113.87	6.01	2.00	-4.80	0.07	-52.04	0.35	-160.03	10.95
18	0.80	108.30	5.50	1.88	-10.80	0.07	-55.52	0.36	-155.48	10.54

**Typical Noise Parameters**

Freq GHz	Fmin dB	$\Gamma_{opt}$ Mag.	$\Gamma_{opt}$ Ang.	Rn/50	Ga dB
2	0.17	0.727	30.9	0.1	20.9
3	0.24	0.624	46.2	0.1	19.16
4	0.31	0.534	61.1	0.09	17.57
5	0.38	0.457	75.8	0.08	16.12
6	0.44	0.394	90.1	0.08	14.83
7	0.51	0.344	104.1	0.07	13.69
8	0.58	0.307	117.8	0.07	12.69
9	0.65	0.283	131.2	0.06	11.84
10	0.72	0.273	144.3	0.06	11.14
11	0.78	0.276	157.1	0.06	10.59
12	0.85	0.292	169.6	0.06	10.19
13	0.92	0.322	-178.2	0.06	9.94
14	0.99	0.365	-166.3	0.06	9.83
15	1.05	0.421	-154.8	0.06	9.87
16	1.12	0.49	-143.5	0.07	10.07
17	1.19	0.573	-132.6	0.08	10.41

Note:

1. S-parameters are measured in 50 Ohm test environment.

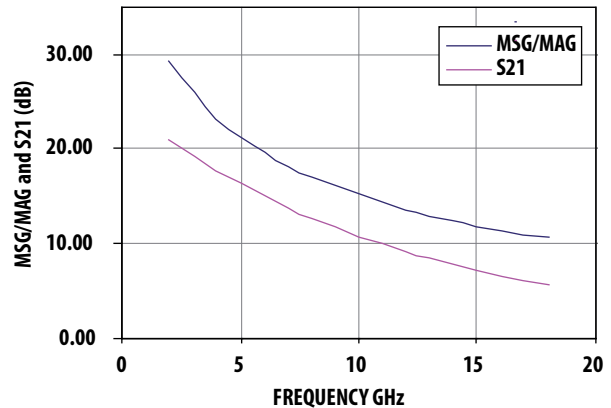

Figure 12. MSG/MAG and S21 vs. Frequency at 2V 20 mA

**VMMK-1218 Typical Scattering Parameters and Noise Parameters,  $T_A=25^\circ\text{C}$ ,  $V_{ds}=1.5\text{V}$ ,  $I_{ds}=20\text{mA}$  [1]**

Freq GHz	S11		S21		S12		S22		MSG/MAG dB	
	Mag.	Ang.	dB	Mag.	Ang.	Mag.	Ang.	Mag.		Ang.
2	0.89	-78.70	20.79	10.95	129.60	0.07	44.02	0.52	-63.66	28.91
3	0.84	-106.97	19.15	9.07	111.99	0.08	28.78	0.46	-87.65	25.57
4	0.80	-129.59	17.52	7.52	97.71	0.09	16.70	0.42	-107.45	22.87
5	0.79	-147.25	16.06	6.35	86.00	0.09	7.26	0.39	-123.04	20.94
6	0.78	-161.95	14.74	5.46	75.76	0.10	-1.08	0.37	-136.55	19.39
7	0.77	-174.30	13.53	4.75	66.54	0.10	-7.98	0.36	-148.06	18.04
8	0.77	175.11	12.45	4.19	58.04	0.10	-14.20	0.35	-158.27	16.90
9	0.77	165.97	11.42	3.72	50.15	0.09	-19.91	0.35	-167.52	15.86
10	0.77	157.70	10.49	3.35	42.68	0.09	-25.19	0.35	-175.45	14.95
11	0.77	150.33	9.65	3.04	35.68	0.09	-30.03	0.35	177.45	14.14
12	0.77	143.54	8.87	2.78	28.84	0.09	-34.60	0.36	171.04	13.44
13	0.78	137.15	8.15	2.56	22.27	0.09	-38.83	0.36	164.96	12.80
14	0.78	131.00	7.49	2.37	15.98	0.09	-43.10	0.37	159.55	12.22
15	0.78	125.21	6.88	2.21	9.72	0.08	-47.12	0.37	154.60	11.66
16	0.79	119.39	6.31	2.07	3.42	0.08	-51.06	0.38	150.08	11.18
17	0.79	113.54	5.80	1.95	-2.83	0.08	-54.94	0.39	145.54	10.75
18	0.79	107.95	5.29	1.84	-8.68	0.08	-58.30	0.40	141.40	10.32

**Typical Noise Parameters**

Freq GHz	Fmin dB	$\Gamma_{opt}$ Mag.	$\Gamma_{opt}$ Ang.	Rn/50	Ga dB
2	0.16	0.717	32.4	0.10	21.86
3	0.24	0.620	48.1	0.10	19.89
4	0.31	0.536	63.5	0.09	18.08
5	0.39	0.464	78.4	0.08	16.45
6	0.47	0.405	93.0	0.08	14.99
7	0.55	0.359	107.1	0.07	13.70
8	0.63	0.326	120.7	0.06	12.59
9	0.70	0.305	134.0	0.06	11.64
10	0.78	0.297	146.9	0.06	10.87
11	0.86	0.302	159.3	0.06	10.27
12	0.94	0.319	171.3	0.05	9.84
13	1.02	0.349	-177.1	0.05	9.59
14	1.09	0.392	-165.9	0.05	9.51
15	1.17	0.447	-155.1	0.05	9.59
16	1.25	0.515	-144.8	0.06	9.85
17	1.33	0.596	-134.8	0.08	10.29

Note:

1. S-parameters are measured in 50 Ohm test environment.

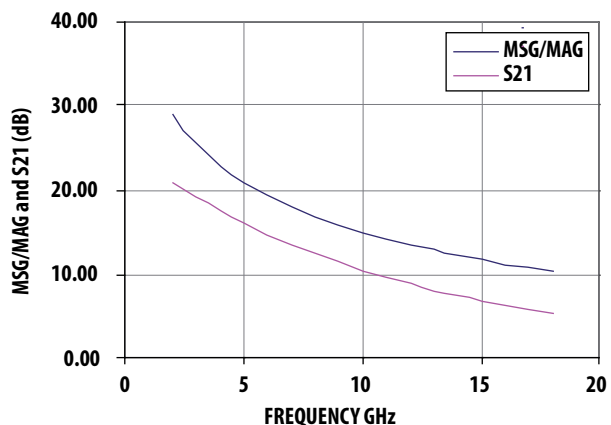

Figure 13. MSG/MAG and S21 vs. Frequency at 1.5V 20 mA

**VMMK-1218 Typical Scattering Parameters and Noise Parameters,  $T_A=25^\circ\text{C}$ ,  $V_{ds}=3\text{V}$ ,  $I_{ds}=20\text{mA}$  [1]**

Freq GHz	S11			S21		S12		S22		MSG/MAG
	Mag.	Ang.	dB	Mag.	Ang.	Mag.	Ang.	Mag.	Ang.	dB
2	0.90	-78.41	20.88	11.07	129.30	0.05	44.78	0.59	-45.41	29.71
3	0.85	-106.62	19.27	9.19	111.50	0.06	29.68	0.50	-61.56	26.11
4	0.82	-129.23	17.67	7.65	96.89	0.07	17.84	0.43	-74.78	23.29
5	0.80	-146.90	16.21	6.47	84.82	0.07	8.51	0.38	-85.37	21.29
6	0.79	-161.57	14.90	5.56	74.28	0.07	0.60	0.35	-94.96	19.70
7	0.78	-173.94	13.71	4.85	64.67	0.07	-6.02	0.32	-103.77	18.32
8	0.78	175.49	12.63	4.28	55.85	0.07	-12.05	0.31	-112.18	17.17
9	0.78	166.35	11.62	3.81	47.60	0.07	-17.59	0.30	-120.67	16.14
10	0.78	158.10	10.70	3.43	39.76	0.07	-22.09	0.29	-128.21	15.23
11	0.79	150.68	9.87	3.11	32.39	0.07	-26.72	0.29	-135.58	14.44
12	0.79	143.93	9.09	2.85	25.16	0.07	-30.99	0.30	-142.88	13.76
13	0.79	137.47	8.38	2.62	18.21	0.07	-34.81	0.31	-149.97	13.11
14	0.80	131.33	7.71	2.43	11.48	0.06	-38.24	0.31	-156.46	12.54
15	0.80	125.54	7.11	2.27	4.87	0.06	-40.97	0.33	-162.44	12.02
16	0.80	119.64	6.53	2.12	-1.87	0.06	-44.55	0.34	-168.20	11.55
17	0.81	113.80	6.00	2.00	-8.47	0.06	-46.49	0.35	-174.07	11.14
18	0.81	108.24	5.48	1.88	-14.69	0.06	-49.45	0.36	-179.63	10.72

**Typical Noise Parameters**

Freq GHz	Fmin dB	$\Gamma_{opt}$ Mag.	$\Gamma_{opt}$ Ang.	Rn/50	Ga dB
2	0.16	0.72	30.40	0.10	20.29
3	0.23	0.62	45.50	0.10	18.62
4	0.30	0.53	60.30	0.09	17.08
5	0.37	0.45	74.80	0.08	15.69
6	0.44	0.39	89.10	0.08	14.44
7	0.50	0.34	103.00	0.07	13.34
8	0.57	0.30	116.70	0.07	12.37
9	0.64	0.28	130.10	0.07	11.55
10	0.71	0.27	143.20	0.06	10.87
11	0.77	0.27	156.00	0.06	10.34
12	0.84	0.29	168.60	0.06	9.95
13	0.91	0.31	-179.20	0.06	9.70
14	0.98	0.36	-167.20	0.06	9.59
15	1.05	0.41	-155.50	0.06	9.63
16	1.11	0.48	-144.10	0.07	9.81
17	1.18	0.56	-132.90	0.08	10.13

Note:

1. S-parameters are measured in 50 Ohm test environment.

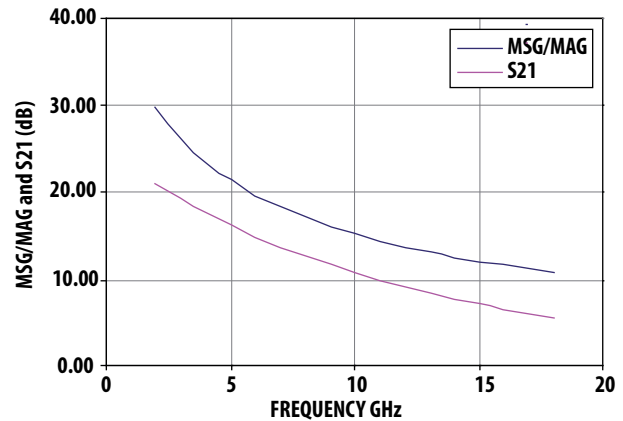

Figure 14. MSG/MAG and S21 vs. Frequency at 3V 20 mA

## Small Signal Model Parameters

Parameter	Value	Parameter	Value	Parameter	Value	Parameter	Value
Vd (V)	1.5	Vd (V)	1.5	Vd (V)	1.5	Vd (V)	1.5
Id (mA)	5	Id (mA)	10	Id (mA)	15	Id (mA)	20
Gm	0.1162	Gm	0.2019	Gm	0.2374	Gm	0.3249
tau	0.00188	tau	0.002388	tau	0.002702	tau	0.00271
Cgs	0.5131	Cgs	0.6732	Cgs	0.8077	Cgs	0.929
Rgs	0.2126	Rgs	0.02638	Rgs	0.02069	Rgs	0.0304
Cgd	0.06932	Cgd	0.06226	Cgd	0.0777	Cgd	0.07133
Cds	0.1587	Cds	0.1574	Cds	0.1606	Cds	0.1597
Rds	334.70	Rds	187.10	Rds	154.10	Rds	123.80

Parameter	Value	Parameter	Value	Parameter	Value	Parameter	Value
Vd (V)	2	Vd (V)	2	Vd (V)	2	Vd (V)	2
Id (mA)	5	Id (mA)	10	Id (mA)	15	Id (mA)	20
Gm	0.1159	Gm	0.1992	Gm	0.1992	Gm	0.3199
tau	0.002146	tau	0.002394	tau	0.002394	tau	0.00257
Cgs	0.5661	Cgs	0.7445	Cgs	0.7445	Cgs	1.04381
Rgs	0.2293	Rgs	0.01936	Rgs	0.01936	Rgs	0.01756
Cgd	0.07976	Cgd	0.0726	Cgd	0.0726	Cgd	0.0606
Cds	0.1631	Cds	0.16078	Cds	0.16078	Cds	0.1607
Rds	357.50	Rds	222.00	Rds	222.00	Rds	141.70

Parameter	Value	Parameter	Value	Parameter	Value	Parameter	Value
Vd (V)	3	Vd (V)	3	Vd (V)	3	Vd (V)	3
Id (mA)	5	Id (mA)	10	Id (mA)	15	Id (mA)	20
Gm	0.1112	Gm	0.193	Gm	0.258	Gm	0.3119
tau	0.00249	tau	0.0025	tau	0.00252	tau	0.002487
Cgs	0.6365	Cgs	0.8786	Cgs	1.08192	Cgs	1.26
Rgs	0.007447	Rgs	0.1353	Rgs	0.01	Rgs	0.0271
Cgd	0.06521	Cgd	0.0582	Cgd	0.053	Cgd	0.04772
Cds	0.1603	Cds	0.1595	Cds	0.1601	Cds	0.1595
Rds	438.90	Rds	260.60	Rds	209.10	Rds	172.90

Parameter	Value	Parameter	Value	Parameter	Value	Parameter	Value
Vd (V)	4	Vd (V)	4	Vd (V)	4	Vd (V)	4
Id (mA)	5	Id (mA)	10	Id (mA)	15	Id (mA)	20
Gm	0.1088	Gm	0.1909	Gm	0.2509	Gm	0.3053
tau	0.00264	tau	0.002635	tau	0.002613	tau	0.00261
Cgs	0.6765	Cgs	0.9774	Cgs	1.203	Cgs	1.412
Rgs	0.00818	Rgs	0.1478	Rgs	0.01263	Rgs	0.02727
Cgd	0.05762	Cgd	0.05065	Cgd	0.04603	Cgd	0.04153
Cds	0.1565	Cds	0.1573	Cds	0.1574	Cds	0.1579
Rds	564.30	Rds	312.10	Rds	242.20	Rds	200.30



## S Parameter Measurements

The S-parameters are measured on a .016 inch thick RO4003 printed circuit test board, using G-S-G (ground signal ground) probes. Coplanar waveguide is used to provide a smooth transition from the probes to the device under test. The presence of the ground plane on top of the test board results in excellent grounding at the device under test. A combination of SOLT (Short - Open - Load - Thru) and TRL (Thru - Reflect - Line) calibration techniques are used to correct for the effects of the test board, resulting in accurate device S-parameters. The reference plane for the S Parameters is at the edge of the package.

## VMMK-1218 ADS Model

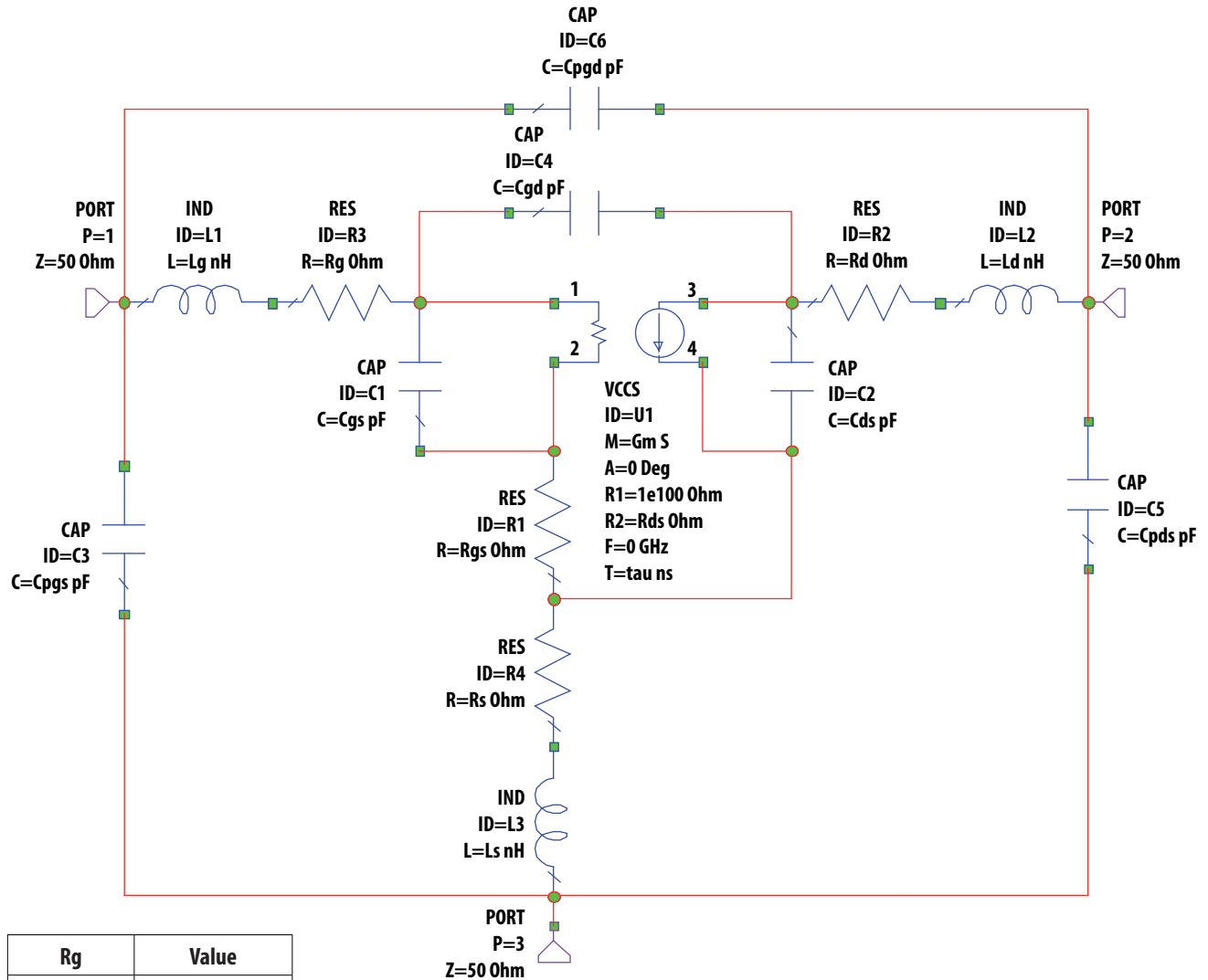

Rg	Value
Rg	4.729
Rd	1.29495
RsG	2.283
C pgs	0.0475
C pds	0.0318
C pgd	0.00417
Ls	0.000559
Lg	0.32446
Ld	0.2602

## Outline Drawing

### Top and Side View

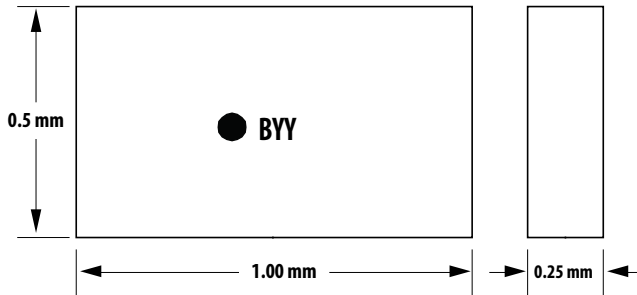

### Bottom View

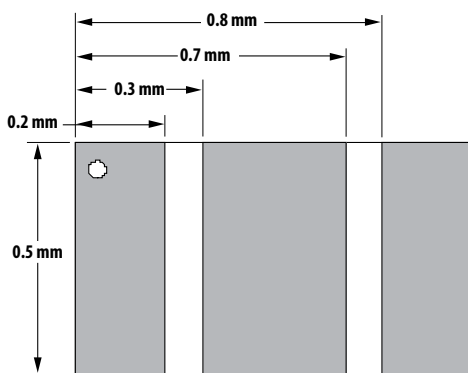

#### Notes:

- indicates pin 1
- Dimensions are in millimeters
- Pad Material is minimum 5.0 um thick Au

## Suggested PCB Material and Land Pattern

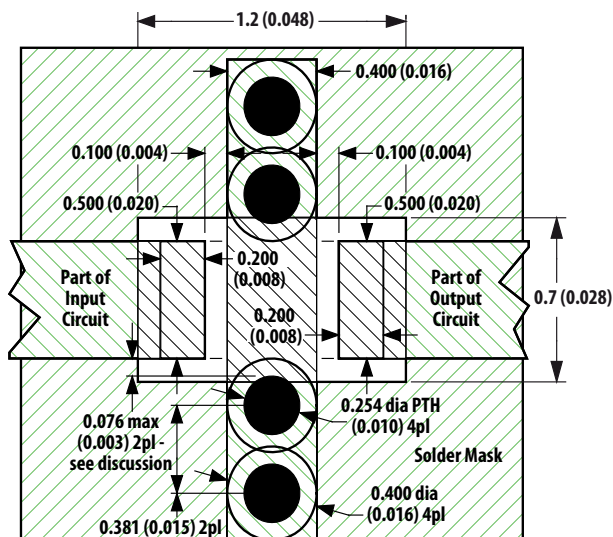

#### Notes:

- 0.010" Rogers RO4350

## Recommended SMT Attachment

The VMMK Packaged Devices are compatible with high volume surface mount PCB assembly processes.

### Manual Assembly for Prototypes

- Follow ESD precautions while handling packages.
- Handling should be along the edges with tweezers or from topside if using a vacuum collet.
- Recommended attachment is solder paste. Please see Figure 8 for recommended solder reflow profile. Conductive epoxy is not recommended. Hand soldering is not recommended.
- Apply solder paste using either a stencil printer or dot placement. The volume of solder paste will be dependent on PCB and component layout and should be controlled to ensure consistent mechanical and electrical performance. Excessive solder will degrade RF performance.
- Follow solder paste and vendor's recommendations when developing a solder reflow profile. A standard profile will have a steady ramp up from room temperature to the pre-heat temp to avoid damage due to thermal shock.
- Packages have been qualified to withstand a peak temperature of 260°C for 20 to 40 sec. Verify that the profile will not expose device beyond these limits.
- Clean off flux per vendor's recommendations.
- Clean the module with Acetone. Rinse with alcohol. Allow the module to dry before testing.

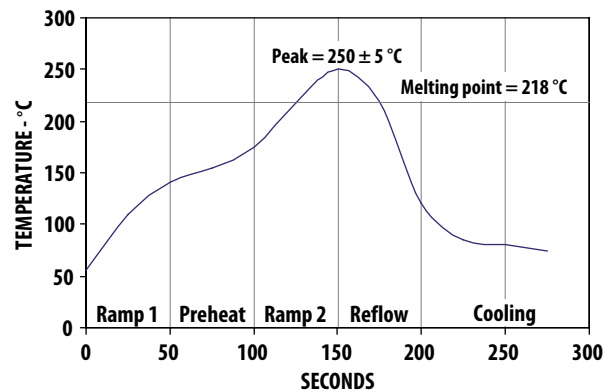
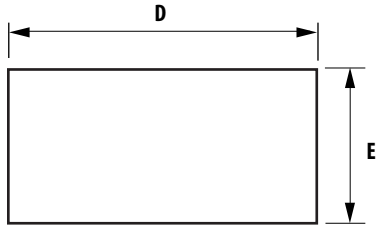

Figure 15. Suggested Lead-Free Reflow Profile for SnAgCu Solder Paste

### Part Number Ordering Information

Part Number	No. of Devices	Container
VMMK-1218-BLKG	100	antistatic bag
VMMK-1218-TR1G	5000	7" Reel

## Package Dimension Outline



Symbol	Min (mm)	Max (mm)
D	1.004	1.085
E	0.500	0.585
A	0.225	0.275



Notes:  
All dimensions are in mm

## Device Orientation

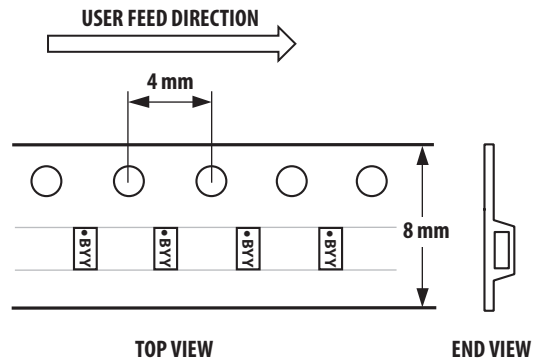
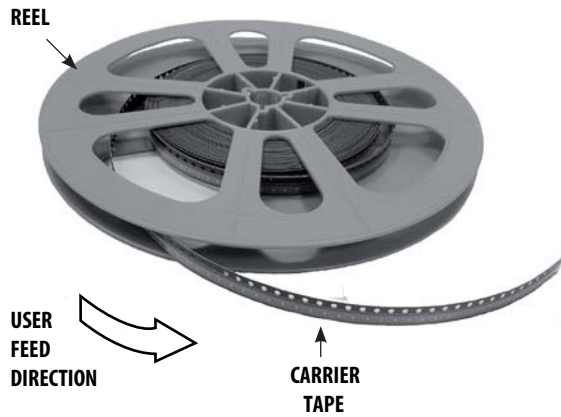

Notes:  
"B" = Device Code  
"YY" = Month Code

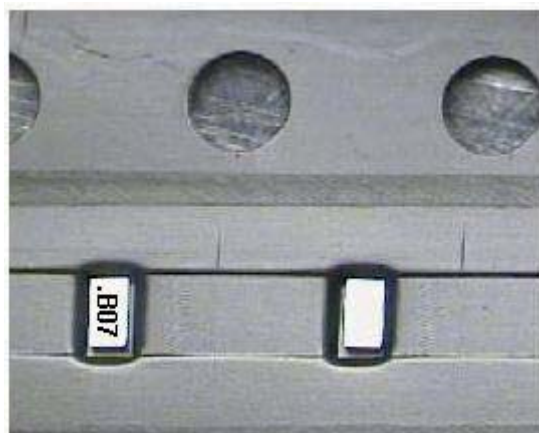

## Tape Dimensions

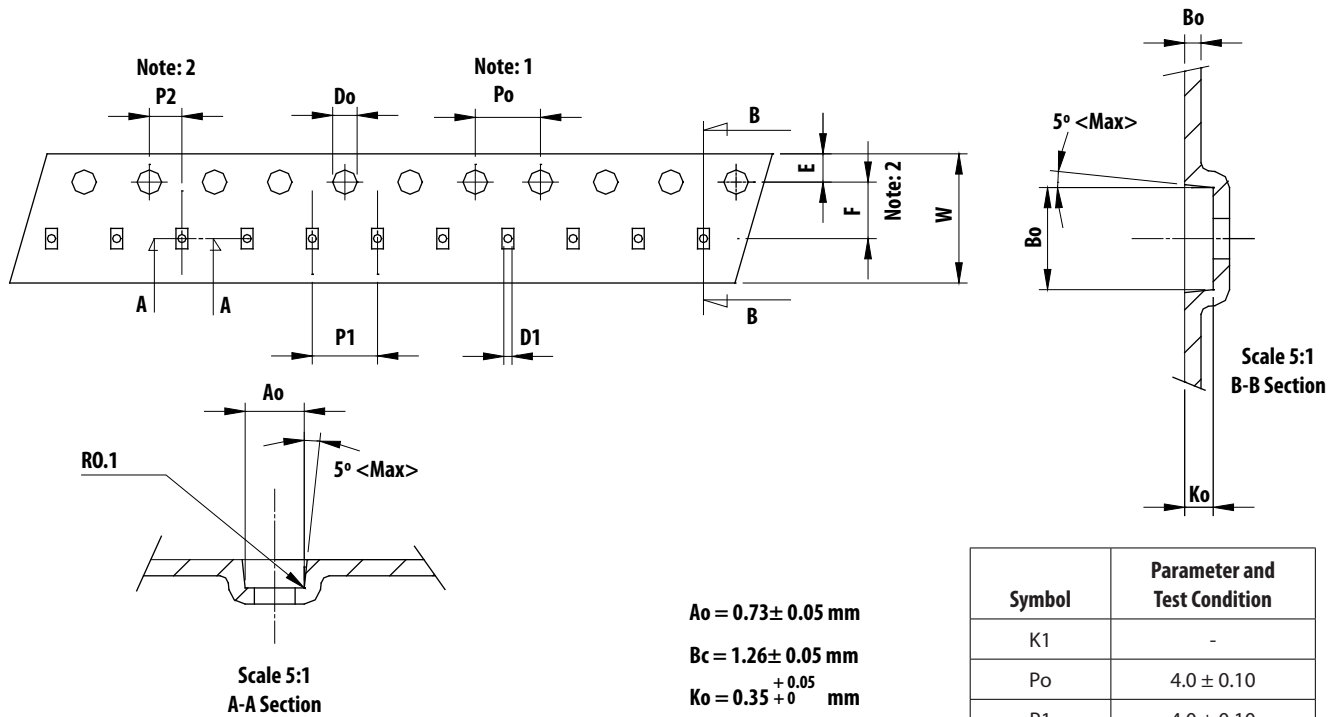

Symbol	Parameter and Test Condition
K1	-
Po	4.0 ± 0.10
P1	4.0 ± 0.10
P2	2.0 ± 0.05
Do	1.55 ± 0.05
D1	0.5 ± 0.05
E	1.75 ± 0.10
F	3.50 ± 0.05
10Po	40.0 ± 0.10
W	8.0 ± 0.20
T	0.20 ± 0.02

Unit: mm

### Notes:

- 10 sprocket hole pitch cumulative tolerance is ±0.1 mm
- Pocket position relative to sprocket hole measured as true position of pocket not pocket hole
- Ao & Bo measured on a plane 0.3mm above the bottom of the pocket to top surface of the carrier
- Ko measured from a plane on the inside bottom of the pocket to the top surface of the carrier
- Carrier camber shall be not than 1mm per 100mm through a length of 250mm

For product information and a complete list of distributors, please go to our web site: [www.avagotech.com](http://www.avagotech.com)

Avago, Avago Technologies, and the A logo are trademarks of Avago Technologies in the United States and other countries. Data subject to change. Copyright © 2005-2012 Avago Technologies. All rights reserved.  
AV02-1081EN - February 2, 2012

**AVAGO**  
TECHNOLOGIES

## X-ON Electronics

Largest Supplier of Electrical and Electronic Components

*Click to view similar products for [RF JFET Transistors](#) category:*

*Click to view products by [Broadcom](#) manufacturer:*

Other Similar products are found below :

[XF1001-SC-EV1](#) [CE3514M4](#) [CE3514M4-C2](#) [CE3520K3-C1](#) [CE3521M4](#) [CE3521M4-C2](#) [CE3512K2-C1](#) [NPT25100B](#) [CE3520K3](#)  
[CGH55030F1](#) [CGH27030F](#) [QPD0020](#) [CGH25120F](#) [CMPA801B030F](#) [TGF2023-2-01](#) [TGF2023-2-02](#) [CGH40006P](#) [QPD1009](#) [MAGX-](#)  
[011086](#) [QPD1014SR](#) [T2G6000528-Q3](#) [CG2H40025F](#) [CGHV40200PP](#) [CGHV40050F](#) [CGHV14800F](#) [CGH27030P](#) [CGH09120F](#)  
[CG2H80015D-GP4](#) [CG2H40045F](#) [T2G4003532-FL](#) [TGF2942](#) [T2G6003028-FS](#) [T2G6003028-FL](#) [T2G6000528-Q3](#) [28V](#) [T2G4003532-FS](#)  
[T1G2028536-FL](#) [QPD1015L](#) [QPD1015](#) [QPD1010](#) [QPD1008L](#) [QPD1008](#) [QPD1000](#) [JANTXV2N4858](#) [ATF-521P8-BLK](#) [J175D26Z](#) [AGX-](#)  
[1/2](#) [CE3512K2](#) [2N3819](#) [CGH55030F2](#) [CGHV40180F](#)