

### MLA Varistor Series

RoHS HF



#### Size Table

Metric	EIA
1005	0402
1608	0603
2012	0805
3216	1206
3225	1210

#### Absolute Maximum Ratings

• For ratings of individual members of a series, see device ratings and specifications table.

Continuous	ML Series	Units
<b>Steady State Applied Voltage:</b>		
DC Voltage Range ( $V_{M(DC)}$ )	3.5 to 120	V
AC Voltage Range ( $V_{M(AC)(RMS)}$ )	2.5 to 107	V
<b>Transient:</b>		
Non-Repetitive Surge Current, 8/20 $\mu$ s Waveform, ( $I_{TM}$ )	4 to 500	A
Non-Repetitive Surge Energy, 10/1000 $\mu$ s Waveform, ( $W_{TM}$ )	0.02 to 2.5	J
Operating Ambient Temperature Range ( $T_A$ )	-55 to +125	°C
Storage Temperature Range ( $T_{STG}$ )	-55 to +150	°C
Temperature Coefficient ( $\alpha V$ ) of Clamping Voltage ( $V_C$ ) at Specified Test Current	<0.01	%/°C

#### Additional Information



Datasheet



Resources



Samples

#### Description

The MLA Series family of transient voltage surge suppression devices is based on the Littelfuse Multilayer fabrication technology. These components are designed to suppress a variety of transient events, including those specified in IEC 61000-4-2 or other standards used for Electromagnetic Compliance (EMC). The MLA Series is typically applied to protect integrated circuits and other components at the circuit board level.

The wide operating voltage and energy range make the MLA Series suitable for numerous applications on power supply, control and signal lines.

The MLA Series is manufactured from semiconducting ceramics, and is supplied in a leadless, surface mount package. The MLA Series is compatible with modern reflow and wave soldering procedures.

It can operate over a wider temperature range than Zener diodes, and has a much smaller footprint than plastic-housed components.

Littelfuse Inc. manufactures other multilayer series products. See the MLE Series data sheet for ESD applications, MHS Series data sheet for high-speed ESD applications, the MLN Series for multilayer protection and the AUML Series for automotive applications.

#### Features

- Halogen-Free and RoHS compliant
- Leadless 0402, 0603, 0805, 1206 and 1210 chip sizes
- Multilayer ceramic construction technology
- -55°C to +125°C operating temp. range
- Operating voltage range  $V_{M(DC)} = 5.5V$  to 120V
- Rated for surge current ( $8 \times 20\mu s$ )
- Rated for energy ( $10 \times 1000\mu s$ )
- Inherent bi-directional clamping
- Standard low capacitance types available
- ESD rated to IEC 61000-4-2, Level 4: Air Discharge 15KV and Contact Discharge 8KV

#### Applications

- Suppression of inductive switching or other transient events such as EFT and surge voltage at the circuit board level
- ESD protection for IEC 61000-4-2 (Level 4), MIL-STD-883 method 3015.7, and other industry specifications (see also the MLE or MLN Series)
- Provides on-board transient voltage protection for ICS and transistors
- Used to help achieve electromagnetic compliance of end products
- Replace larger surface mount TVS Zeners in many applications

**Device Ratings and Specifications**

Part Number	Maximum Ratings (125° C)					Specifications (25°C)		
	Maximum Continuous Working Voltage		Maximum Non-repetitive Surge Current (8/20 $\mu$ s)	Maximum Non-repetitive Surge Energy (10/1000 $\mu$ s)	Maximum Clamping Voltage at 1A (or as Noted) (8/20 $\mu$ s)	Nominal Voltage at 1mA DC Test Current		Typical Capacitance at f = 1MHz
	V <sub>M(DC)</sub> (V)	V <sub>M(AC)</sub> (V)	I <sub>TM</sub> (A)	W <sub>TM</sub> (J)	V <sub>C</sub> (V)	V <sub>N(DC)</sub> Min (V)	V <sub>N(DC)</sub> Max (V)	C (pF)
V3.5MLA0603N <sup>5</sup>	3.5	2.5	30	0.100	13.0	3.7	7.0	1270
V3.5MLA0805N	3.5	2.5	120	0.300	13.0	3.7	7.0	1760
V3.5MLA0805LN	3.5	2.5	40	0.100	13.0	3.7	7.0	1380
V3.5MLA1206N	3.5	2.5	100	0.300	13.0	3.7	7.0	5800
V5.5MLA0402N	5.5	4.0	20	0.050	21.0	7.1	10.8	220
V5.5MLA0402F <sup>8</sup>	5.5	4.0	20	0.050	21.0	7.1	10.8	220
V5.5MLA0402LN	5.5	4.0	20	0.050	39.0	15.9	21.5	70
V5.5MLA0402LF <sup>8</sup>	5.5	4.0	20	0.05	39	15.9	21.5	70
V5.5MLA0603N <sup>5</sup>	5.5	4.0	30	0.100	17.5	7.1	9.3	960
V5.5MLA0603LN <sup>4</sup>	5.5	4.0	30	0.100	17.5	7.1	9.3	450
V5.5MLA0603LF <sup>8</sup>	5.5	4.0	30	0.100	17.5	7.1	9.3	450
V5.5MLA0805N	5.5	4.0	120	0.300	17.5	7.1	9.3	1200
V5.5MLA0805LN	5.5	4.0	40	0.100	17.5	7.1	9.3	660
V5.5MLA1206N	5.5	4.0	150	0.400	17.5	7.1	9.3	2800
V9MLA0402N	9.0	6.5	20	0.050	30.0	11.0	16.0	120
V9MLA0402F <sup>8</sup>	9.0	6.5	20	0.050	30.0	11.0	16.0	120
V9MLA0402LN	9.0	6.5	4	0.020	35.0	11.0	16.0	33
V9MLA0402LF <sup>8</sup>	9.0	6.5	4	0.020	35.0	11.0	16.0	33
V9MLA0603N <sup>5</sup>	9.0	6.5	30	0.100	25.5	11.0	16.0	490
V9MLA0603LN <sup>4</sup>	9.0	6.5	30	0.100	25.5	11.0	16.0	360
V9MLA0603LF <sup>8</sup>	9.0	6.5	30	0.100	25.5	11.0	16.0	360
V9MLA0805LN	9.0	6.5	40	0.100	25.5	11.0	16.0	320
V12MLA0805LN	12.0	9.0	40	0.100	29.0	14.0	18.5	220
V14MLA0402N	14.0	10.0	20	0.050	39.0	15.9	21.5	70
V14MLA0402F <sup>8</sup>	14.0	10.0	20	0.050	39.0	15.9	21.5	70
V14MLA0603N	14.0	10.0	30	0.100	34.5	15.9	21.5	80
V14MLA0603F <sup>8</sup>	14.0	10.0	30	0.100	34.5	15.9	21.5	180
V14MLA0805N	14.0	10.0	120	0.300	32.0	15.9	20.3	360
V14MLA0805LN	14.0	10.0	40	0.100	32.0	15.9	20.3	200
V14MLA1206N	14.0	10.0	150	0.400	32.0	15.9	20.3	800
V18MLA0402N	18.0	14.0	20	0.050	50.0	22.0	28.0	40
V18MLA0402F <sup>8</sup>	18.0	14.0	20	0.050	50.0	22.0	28.0	40
V18MLA0603N	18.0	14.0	30	0.100	50.0	22.0	28.0	60
V18MLA0603F <sup>8</sup>	18.0	14.0	30	0.100	50.0	22.0	28.0	120
V18MLA0805N	18.0	14.0	120	0.300	44.0	22.0	28.0	260
V18MLA0805LN	18.0	14.0	40	0.100	44.0	22.0	28.0	170
V18MLA1206N	18.0	14.0	150	0.400	44.0	22.0	28.0	1030
V18MLA1210N	18.0	14.0	500	2.500	44.0 at 2.5	22.0	28.0	2500
V18MLA1812N <sup>7</sup>	18.0	14.0	1000	2.900	44.0 at 5	22.0	28.0	4050
V26MLA0603N	26.0	20.0	30	0.100	60.0	31.0	38.0	55
V26MLA0603F <sup>8</sup>	26.0	20.0	30	0.100	60.0	31.0	38.0	110
V26MLA0805N	26.0	20.0	100	0.300	60.0	29.5	38.5	110
V26MLA0805LN	26.0	20.0	40	0.100	60.0	29.5	38.5	90
V26MLA1206N	26.0	20.0	150	0.600	60.0	29.5	38.5	630
V26MLA1210N	26.0	20.0	300	1.200	60.0 at 2.5	29.5	38.5	1250
V30MLA0603N	30.0	25.0	30	0.100	74.0	37.0	46.0	45
V30MLA0603F <sup>8</sup>	30.0	25.0	30	0.100	74.0	37.0	46.0	90
V30MLA0805LN	30.0	25.0	30	0.100	72.0	37.0	46.0	85
V30MLA1206N	30.0	25.0	180	1.000	67.0	35.0	43.0	400
V30MLA1210N	30.0	25.0	280	1.200	68.0 at 2.5	35.0	43.0	685
V30MLA1210LN	30.0	25.0	220	0.900	68.0 at 2.5	35.0	43.0	500

### Device Ratings and Specifications (Continue...)

Part Number	Maximum Ratings (125° C)				Specifications (25° C)			
	Maximum Continuous Working Voltage		Maximum Non-repetitive Surge Current (8/20 $\mu$ s)	Maximum Non-repetitive Surge Energy (10/1000 $\mu$ s)	Maximum Clamping Voltage at 1A (or as Noted) (8/20 $\mu$ s)	Nominal Voltage at 1mA DC Test Current		Typical Capacitance at f = 1MHz
	V <sub>M(DC)</sub> (V)	V <sub>M(AC)</sub> (V)	I <sub>TM</sub> (A)	W <sub>TM</sub> (J)	V <sub>c</sub> (V)	V <sub>N(DC)</sub> Min (V)	V <sub>N(DC)</sub> Max (V)	C (pF)
V30MLA1812N <sup>7</sup>	30.0	25.0	800	3.700	65.0 at 5	35.0	43.0	1900
V33MLA1206N	33.0	26.0	180	0.800	75.0	38.0	49.0	390
V38MLA1812N <sup>7</sup>	38.0	30.0	800	4.500	77.0 at 5	43.0	52.0	1450
V42MLA1206N	42.0	30.0	180	0.800	92.0	46.0	60.0	345
V45MLA1812N <sup>7</sup>	45.0	35.0	500	4.000	90.0 at 5	50.4	61.6	1200
V48MLA1206N	48.0	40.0	180	0.900	100.0	54.5	66.5	185
V48MLA1210N	48.0	40.0	250	1.200	105.0 at 2.5	54.5	66.5	400
V48MLA1210LN	48.0	40.0	220	0.900	105.0 at 2.5	54.5	66.5	380
V56MLA1206N	56.0	40.0	180	1.000	120.0	61.0	77.0	180
V60MLA1210N	60.0	50.0	250	1.500	130.0 at 2.5	67.0	83.0	230
V68MLA1206N	68.0	50.0	180	1.000	140.0	76.0	90.0	130
V85MLA1210N	85.0	67.0	250	2.500	180.0 at 2.5	95.0	115.0	160
V120MLA1210N	120.0	107.0	125	2.000	260.0 at 2.5	135.0	165.0	70

- NOTES:
- 'L' suffix is a low capacitance and energy version; Contact your Littelfuse sales representative for custom capacitance requirements.
  - Typical leakage at 25°C < 25 $\mu$ A, maximum leakage 100 $\mu$ A at V<sub>M(DC)</sub> for 0402 size, typical leakage < 5 $\mu$ A, maximum leakage < 20 $\mu$ A at V<sub>M(DC)</sub>.
  - Average power dissipation of transients for 0402, 0603, 0805, 1206 and 1210 sizes not to exceed 0.03W, 0.05W, 0.1W, 0.1W and 0.15W respectively.
  - Item is available as 'R' packing option only. All 0402 size items available as 'R' packaging option only. See Packaging section for additional information.
  - Item is available in 'H', 'T' and 'A' packing option only. All 0805, 1206 and 1210 parts come as 'H', 'T' and 'A' packing option only. See Packaging section for additional information.
  - The typical capacitance rating is the discrete component test result.
  - Item is available in 'T' packing option only.
  - Item is available in 'R' packing option only, and lead free.

**Peak Current and Energy Derating Curve**

When transients occur in rapid succession, the average power dissipation is the energy (watt-seconds) per pulse times the number of pulses per second. The power so developed must be within the specifications shown on the Device Ratings and Specifications Table for the specific device. For applications exceeding 125°C ambient temperature, the peak surge current and energy ratings must be derated as shown below.

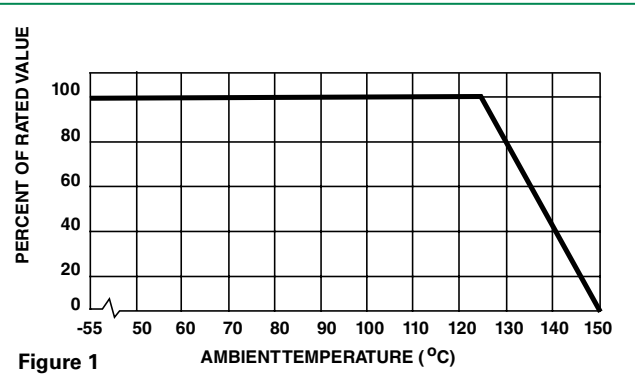

**Peak Pulse Current Test Waveform for Clamping Voltage**

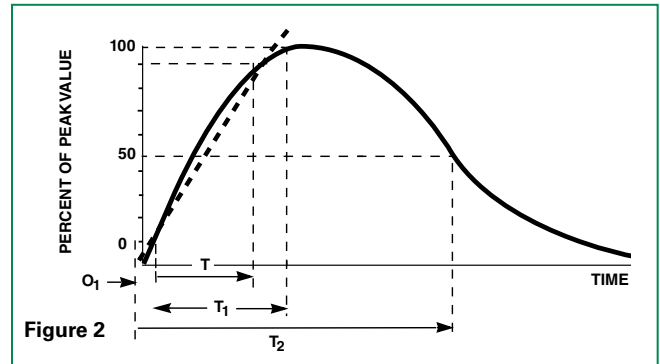

- $O_1$  = Virtual Origin of Wave
- T = Time from 10% to 90% of Peak
- $T_1$  = Rise Time =  $1.25 \times T$
- $T_2$  = Decay Time

**Example** - For an 8/20  $\mu$ s Current Waveform:  
 $8\mu s = T_1 =$  Rise Time  
 $20\mu s = T_2 =$  Decay Time

**Limit V-I Characteristic for V5.5MLA0402 to V18MLA0402**

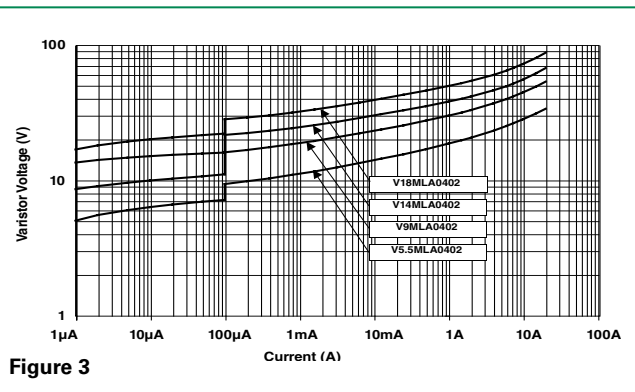

**Limit V-I Characteristic for V9MLA0402L**

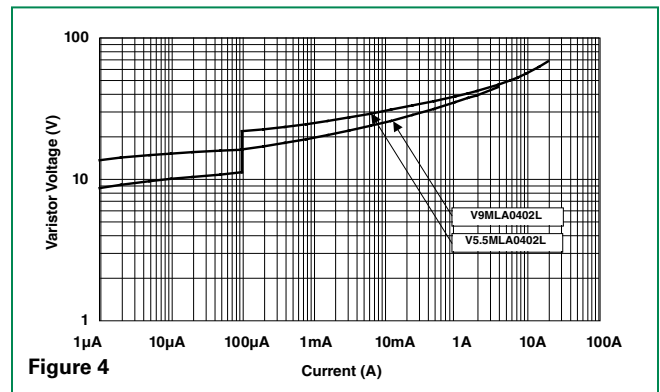

**Limit V-I Characteristic for V3.5MLA0603 to V30MLA0603**

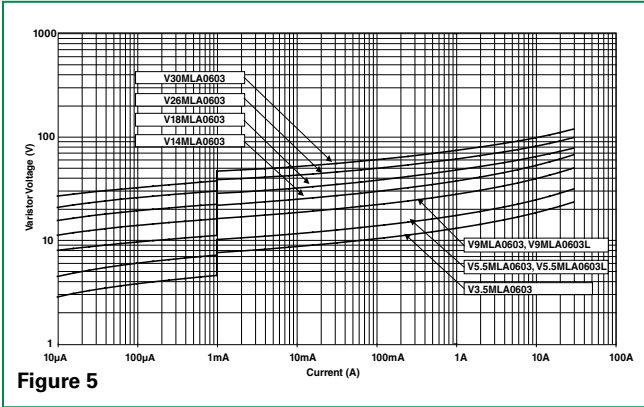

**Figure 5**

**Limit V-I Characteristic for V3.5MLA0805L to V30MLA0805L**

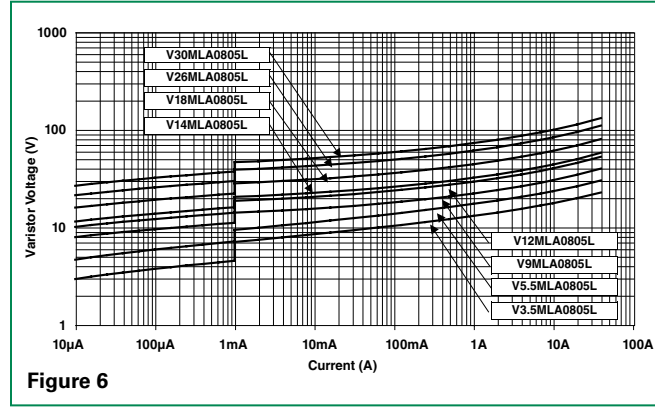

**Figure 6**

**Limit V-I Characteristic for V3.5MLA0805 to V26MLA0805**

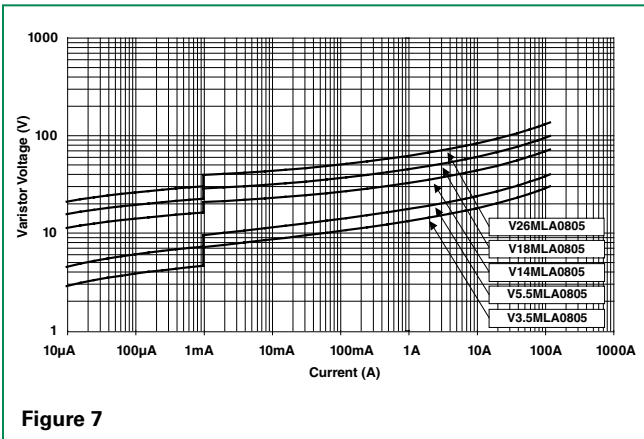

**Figure 7**

**Limit V-I Characteristic for V3.5MLA1206 to V68MLA1206**

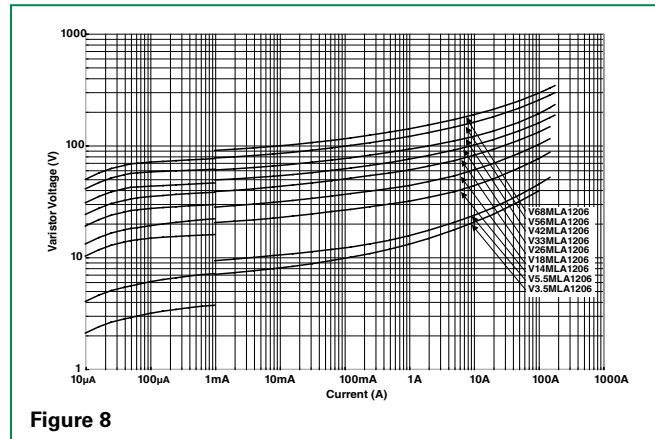

**Figure 8**

**Limit V-I Characteristic for V18MLA1210 to V120MLA1210**

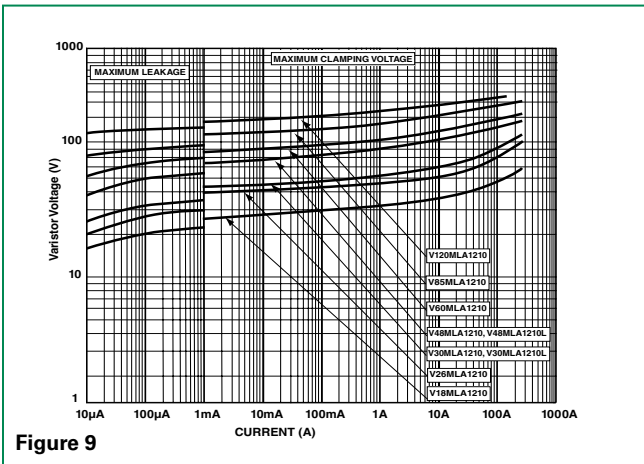

**Figure 9**

**Device Characteristics**

At low current levels, the V-I curve of the multilayer transient voltage suppressor approaches a linear (ohmic) relationship and shows a temperature dependent effect. At or below the maximum working voltage, the suppressor is in a high resistance mode (approaching  $10^6\Omega$  at its maximum rated working voltage). Leakage currents at maximum rated voltage are below  $100\mu A$ , typically  $25\mu A$ ; for 0402 size below  $20\mu A$ , typically  $5\mu A$ .

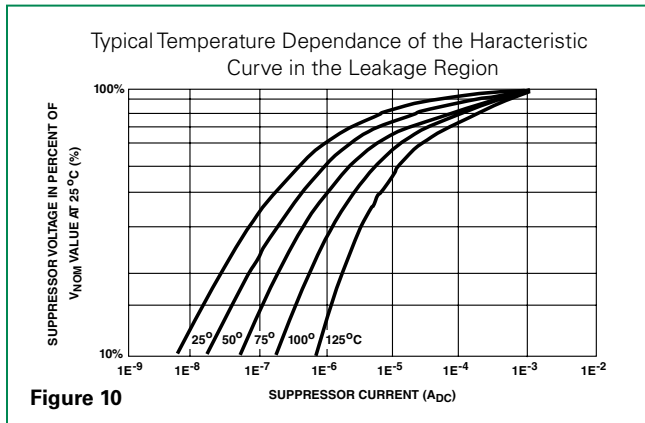

Figure 10

**Speed of Response**

The Multilayer Suppressor is a leadless device. Its response time is not limited by the parasitic lead inductances found in other surface mount packages. The response time of the  $Z_{N}O$  dielectric material is less than 1ns and the MLA can clamp very fast  $dV/dT$  events such as ESD. Additionally, in "real world" applications, the associated circuit wiring is often the greatest factor effecting speed of response. Therefore, transient suppressor placement within a circuit can be considered important in certain instances.

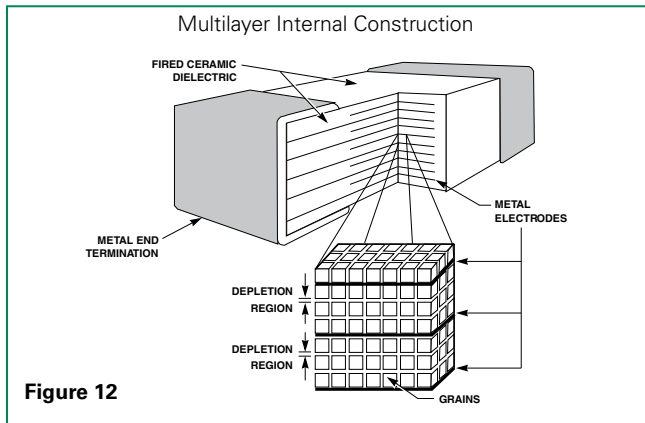

Figure 12

**Clamping Voltage Over Temperature ( $V_c$  at 10A)**

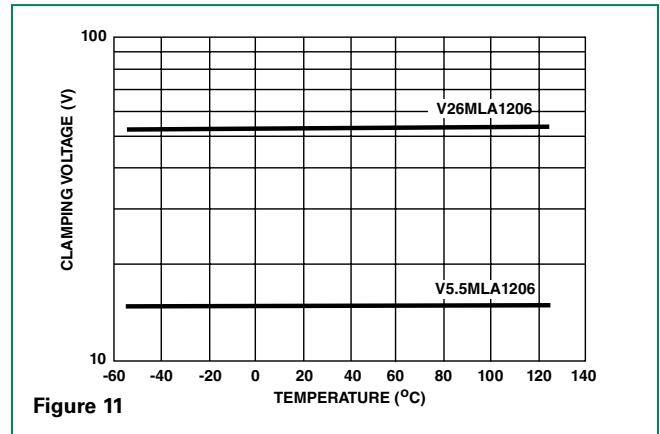

Figure 11

**Energy Absorption/Peak Current Capability**

Energy dissipated within the MLA Series is calculated by multiplying the clamping voltage, transient current and transient duration. An important advantage of the multilayer is its interdigitated electrode construction within the mass of dielectric material. This results in excellent current distribution and the peak temperature per energy absorbed is very low. The matrix of semiconducting grains combine to absorb and distribute transient energy (heat) (see Speed of Response). This dramatically reduces peak temperature; thermal stresses and enhances device reliability.

As a measure of the device capability in energy and peak current handling, the V26MLA1206A part was tested with multiple pulses at its peak current rating (3A, 8/20 $\mu s$ ). At the end of the test, 10,000 pulses later, the device voltage characteristics are still well within specification.

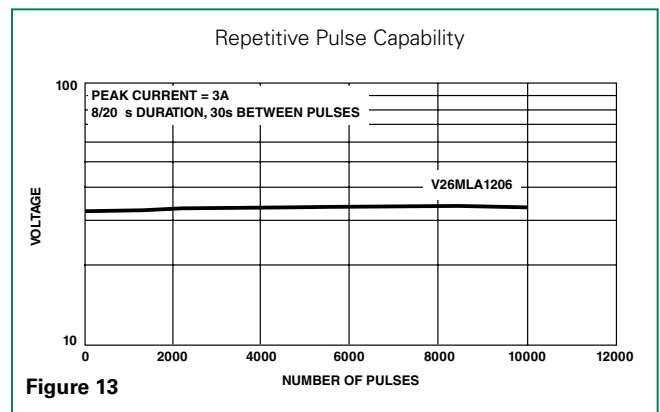

Figure 13

**Lead (Pb) Soldering Recommendations**

The principal techniques used for the soldering of components in surface mount technology are IR Re-flow and Wave soldering. Typical profiles are shown on the right.

The recommended solder for the MLA suppressor is a 62/36/2 (Sn/Pb/Ag), 60/40 (Sn/Pb) or 63/37 (Sn/Pb). Littelfuse also recommends an RMA solder flux.

Wave soldering is the most strenuous of the processes. To avoid the possibility of generating stresses due to thermal shock, a preheat stage in the soldering process is recommended, and the peak temperature of the solder process should be rigidly controlled.

When using a reflow process, care should be taken to ensure that the MLA chip is not subjected to a thermal gradient steeper than 4 degrees per second; the ideal gradient being 2 degrees per second. During the soldering process, preheating to within 100 degrees of the solder's peak temperature is essential to minimize thermal shock.

Once the soldering process has been completed, it is still necessary to ensure that any further thermal shocks are avoided. One possible cause of thermal shock is hot printed circuit boards being removed from the solder process and subjected to cleaning solvents at room temperature. The boards must be allowed to cool gradually to less than 50° C before cleaning.

**Reflow Solder Profile**

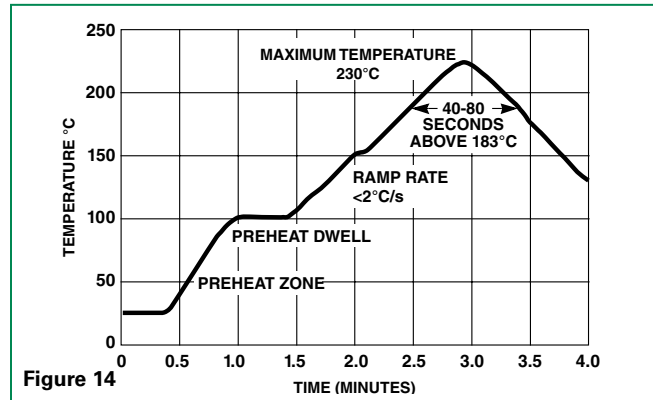

**Wave Solder Profile**

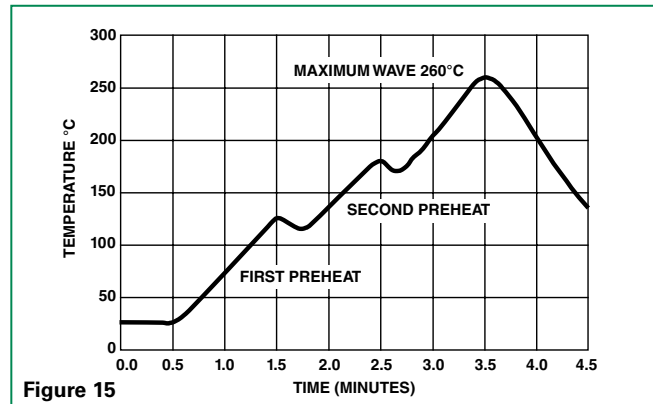

**Lead-free (Pb-free) Soldering Recommendations**

Littelfuse offers the Nickel Barrier Termination option (see "N" suffix in Part Numbering System for ordering) for the optimum Lead-free solder performance, consisting of a Matte Tin outer surface plated on Nickel underlayer, plated on Silver base metal.

The preferred solder is 96.5/3.0/0.5 (SnAgCu) with an RMA flux, but there is a wide selection of pastes and fluxes available with which the Nickel Barrier parts should be compatible.

The reflow profile must be constrained by the maximums in the Lead-free Reflow Profile. For Lead-free wave soldering, the Wave Solder Profile still applies.

Note: the Lead-free paste, flux and profile were used for evaluation purposes by Littelfuse, based upon industry standards and practices. There are multiple choices of all three available, it is advised that the customer explores the optimum combination for their process as processes vary considerably from site to site.

**Lead-free Re-flow Solder Profile**

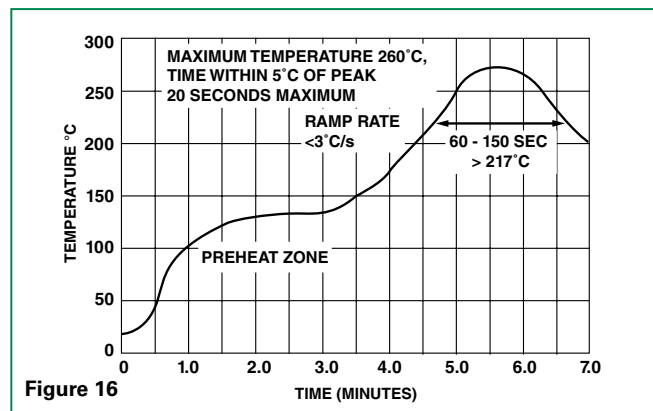

### Product Dimensions (mm)

PAD LAYOUT DIMENSIONS

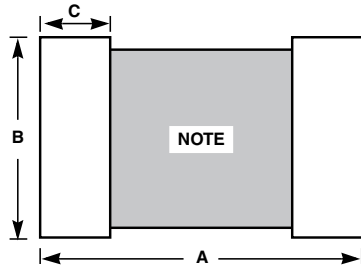

CHIP LAYOUT DIMENSIONS

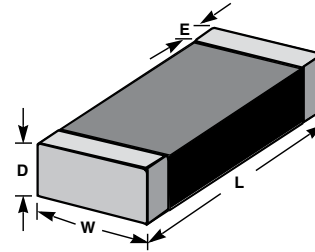

NOTE : Avoid metal runs in this area, parts not recommended for use in applications using Silver (Ag) epoxy paste.

Dimension	1210 Size		1206 Size		0805 Size		0603 Size		0402 Size	
	IN	MM	IN	MM	IN	MM	IN	MM	IN	MM
<b>A</b>	0.160	4.06	0.160	4.06	0.120	3.05	0.100	2.54	0.067	1.70
<b>B</b>	0.100	2.54	0.065	1.65	0.050	1.27	0.030	0.76	0.020	0.51
<b>C</b>	0.040	1.02	0.040	1.02	0.040	1.02	0.035	0.89	0.024	0.61
<b>D (max.)</b>	0.113	2.87	0.071	1.80	0.043	1.10	0.040	1.00	0.024	0.60
<b>E</b>	0.020 -/+0.010	0.50 -/+0.25	0.020 -/+0.010	0.50 -/+0.25	0.020 -/+ 0.010	0.50 -/+ 0.25	0.015 -/+0.008	0.4 -/+0.20	0.010 -/+0.006	0.25 -/+0.15
<b>L</b>	0.125 -/+0.012	3.20 -/+0.30	0.125 -/+0.012	3.20 -/+0.30	0.079 -/+0.008	2.01 -/+0.20	0.063 -/+0.006	1.6 -/+0.15	0.039 -/+0.004	1.00 -/+0.10
<b>W</b>	0.100 -/+0.012	2.54 -/+0.30	0.060 -/+0.011	1.60 -/+0.28	0.049 -/+0.008	1.25 -/+0.20	0.032 -/+0.060	0.8 -/+0.15	0.020 -/+0.004	0.50 -/+0.10

### Part Numbering System

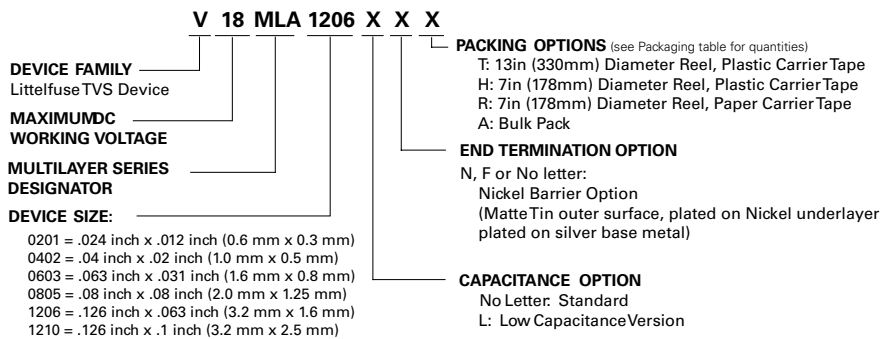

\*NOTES:  
 1 V120MLA1210 standard shipping quantities are 1000 pieces per reel for the "H" option and 4000 pieces per reel for "T" option.  
 2 V3.5 MLA0603, V5.5 MLA0603 and V9 MLA0603 only available in "H," "T" and "A" packing options.

### Packaging\*

Device Size	Quantity			
	13" Inch Reel ("T" Option)	7" Inch Reel ("H" Option)	7" Inch Reel ("R" Option)	Bulk Pack ("A" Option)
1812	4,000	N/A	N/A	N/A
1210	8,000	2,000	N/A	2,000
1206	10,000	2,500	N/A	2,500
0805	10,000	2,500	N/A	2,500
0603	10,000	2,500	4,000	2,500
0402	N/A	N/A	10,000	N/A

\*(Packaging) It is recommended that parts be kept in the sealed bag provided and that parts be used as soon as possible when removed from bags.



**Tape and Reel Specifications**

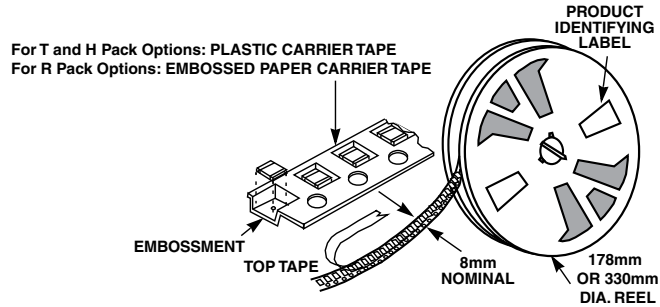
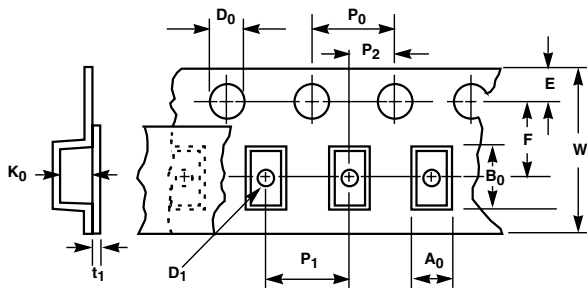

Symbol	Description	Dimensions in Millimeters	
		0402 Size	0603, 0805, 1206 & 1210 Sizes
<b>A<sub>0</sub></b>	Width of Cavity	Dependent on Chip Size to Minimize Rotation.	
<b>B<sub>0</sub></b>	Length of Cavity	Dependent on Chip Size to Minimize Rotation.	
<b>K<sub>0</sub></b>	Depth of Cavity	Dependent on Chip Size to Minimize Rotation.	
<b>W</b>	Width of Tape	8 -/+0.2	8 -/+0.3
<b>F</b>	Distance Between Drive Hole Centers and Cavity Centers	3.5 -/+0.05	3.5 -/+0.05
<b>E</b>	Distance Between Drive Hole Centers and Tape Edge	1.75 -/+0.1	1.75 -/+0.1
<b>P<sub>1</sub></b>	Distance Between Cavity Centers	2 -/+0.05	4 -/+0.1
<b>P<sub>2</sub></b>	Axial Drive Distance Between Drive Hole Centers & Cavity Centers	2 -/+0.1	2 -/+0.1
<b>P<sub>0</sub></b>	Axial Drive Distance Between Drive Hole Centers	4 -/+0.1	4 -/+0.1
<b>D<sub>0</sub></b>	Drive Hole Diameter	1.55 -/+0.05	1.55 -/+0.05
<b>D<sub>1</sub></b>	Diameter of Cavity Piercing	N/A	1.05 -/+0.05
<b>T<sub>1</sub></b>	Top Tape Thickness	0.1 Max	0.1 Max

NOTES:  
 • Conforms to EIA-481-1, Revision A  
 • Can be supplied to IEC publication 286-3

**Disclaimer Notice - Information furnished is believed to be accurate and reliable. However, users should independently evaluate the suitability of and test each product selected for their own applications. Littelfuse products are not designed for, and may not be used in, all applications. Read complete Disclaimer Notice at [www.littelfuse.com/disclaimer-electronics](http://www.littelfuse.com/disclaimer-electronics).**

## X-ON Electronics

Largest Supplier of Electrical and Electronic Components

*Click to view similar products for [Varistors](#) category:*

*Click to view products by [Littelfuse](#) manufacturer:*

Other Similar products are found below :

[820443211E](#) [MLV0402E30703T](#) [MLV0603E30403T](#) [B72205S271K111](#) [B72207S350K311](#) [B72207S381K101](#) [B72260B102K1](#)  
[B72260B251K1](#) [B72280B0381K001](#) [B72280B0461K001](#) [B72280B271K1](#) [B72650M0151K093](#) [B72660M0271K093](#) [S10K11G5S5](#) [ERZ-](#)  
[C07DK221U](#) [TND10V-471KB00AAA0](#) [B72205S301K211](#) [B72207S141K111](#) [B72210S271K111](#) [B72214S350K551](#) [B72220P3351K101](#)  
[B72280B0231K001](#) [B72280B112K1](#) [B72280B381K1](#) [B72590D360A60](#) [B72650M0400K072](#) [B72650M0500K072](#) [B72660M0200K072](#)  
[B72660M1300K072](#) [B72670M1140K72](#) [MLV0603E30703T](#) [MLV0603E32503T](#) [TVZ18EC271KBS](#) [TVZ20EB911KBS](#) [TVZ25D201KBS](#)  
[TVZ25D241KBS](#) [419-2080-101](#) [ERZ-V20R201](#) [MLV0805E31103T](#) [MLV0805E30703T](#) [ERZ-V20R221](#) [B72205S350K211](#)  
[B72210P2511K101](#) [B72214S271K501](#) [B72220P3551K101](#) [B72650M350K72](#) [TVZ20ECN511KBS](#) [TVZ20EC911KBS](#) [TVZ20EBN911KBS](#)  
[TVZ18EC471KBS](#)