



VEO

TIME RELAY / MULTIFUNCTION TIME RELAY

V2ZM10 12-240V AC/DC

Art.Nr.: 125100

V2ZM10P 12-240V AC/DC

Art.Nr.: 125600



- ✓ 10 functions
- ✓ 10 time ranges
- ✓ Supply voltage 12-240 V AC/DC
- ✓ 1 change-over contact
- ✓ Width 22.5mm

Control elements

- ✓ Fine adjustment
- ✓ Setting of time range
- ✓ Function selector

Status indication

- ✓ LED U/t: Supply voltage
- ✓ LED R: Relay status



TECHNICAL DATA

SUPPLY CIRCUIT

Terminals	A1-A2	
Supply voltage	12 ... 240V AC/DC	
Supply voltage tolerance	-10 / +10 %	
Rated frequency	50 / 60Hz or DC	
Rated frequency tolerance	48 ... 63Hz	
Rated consumption	230 V AC	typ. 0,4 W / 0,75 VA
	24 V DC	typ. 0,25 W / 0,25 VA
Standby consumption	230 V AC	typ. 0,16 W / 0,3 VA
	24 V DC	typ. 0,03 W / 0,09 VA
Duty-cycle	100%	
Backup power time	< 30 ms	
Recovery time	> 100 ms	
Drop-out voltage	≥ 7 V	

CONTROL INPUT

Terminals	A1-B1	
Function	start of function	
Type	voltage controlled	
Control voltage	see supply voltage	
Minimum control pulse length	AC	min. 50 ms
	DC	min. 25 ms
Loadable	yes	



VEO

TIME RELAY / MULTIFUNCTION TIME RELAY

V2ZM10 12-240V AC/DC

Art.Nr.: 125100

V2ZM10P 12-240V AC/DC

Art.Nr.: 125600



TIMING CIRCUIT

Time ranges	10	0,05 ... 1 s
		0,15 ... 3 s
		0,5 ... 10 s
		1,5 ... 30 s
		3 ... 60 s
		9 ... 180 s
		0,5 ... 10 min
		3 ... 60 min
		0,5 ... 10 h
		5 ... 100 h

RANGE OF FUNCTIONS

Functions	10	E, R, Wu, Es, Ws, Wa, Ec, Bp, Bi, Wt
-----------	----	--------------------------------------

STATUS INDICATION

Supply voltage / time lapse	LED U/t (green) on	supply voltage applied
	LED U/t (green) flashes	indication of lapse of time
Relay status	LED R (yellow) on	output relay energized

OUTPUT CIRCUIT

Terminals		15-16-18
Kind of output		Relay
Number of contacts	change-over contact	1
Contact material		AgNi
Rated voltage (IEC 60947-5-1)		250V
Maximum switching voltage		400V AC
Minimum switching voltage / switching current		12 V / 10 mA
Rated current (IEC 60947-5-1)	AC-1	8 A / 250 V
	AC-15	1,5 A / 240 V (B300)
	DC-12	8 A / 24 V
	DC-13	0,1 A / 250 V
Endurance	mechanical	30 x 10 ⁶ switching cycles
	electrical (AC-1)	100 x 10 ³ switching cycles
Rated frequency of operation	with load	6/min
	without load	1200/min
Fuse rating		8 A fast acting



VEO

TIME RELAY / MULTIFUNCTION TIME RELAY

V2ZM10 12-240V AC/DC

Art.Nr.: 125100

V2ZM10P 12-240V AC/DC

Art.Nr.: 125600



ACCURACY

Base accuracy	< 1 % (of full scale)
Setting accuracy	< 5 % (of full scale)
Repeat accuracy	< 0,5 % or ± 5 ms
Temperature influence	< 0,01 % / °C
Voltage influence	-
Frequency influence	-

ENVIRONMENTAL CONDITIONS

Ambient temperature	operation	-25 ... +60°C
	storage	-40 ... +70°C
Relative humidity		5 ... 95 %
Vibration	EN 61812-1	10 ... 60 Hz: 0,15 mm; 60 ... 150 Hz: 20 m/s ²
	EN 60947-1	2 ... 13,2 Hz: 1 mm; 13,2 ... 100 Hz: 7 m/s ²
Shock	EN 60947-1	± 150 m/s ² 11 ms

GENERAL DATA

Dimensions	W × H × D	22,5 × 67 × 76 mm
Mounting		DIN rail (EN60715)
Mounting position		any
Housing material		PA 66, self-extinguishing plastic, class V-0
Degree of protection	housing	IP40
	terminals	IP20
Electrical connection	V2ZM10	Screw terminal
Wire size	flexible with wire end ferrule	0,5 ... 2,5 mm ² (20 AWG ... 13 AWG)
	flexible without wire end ferrule	0,5 ... 4 mm ² (20 AWG ... 12 AWG)
	rigid	0,5 ... 4 mm ² (20 AWG ... 12 AWG)
Stripping length		8 mm
Tightening torque		max. 1Nm
Electrical connection	V2ZM10P	Push-in terminal
Wire size	flexible with wire end ferrule	0,25 ... 1,5 mm ² (24 AWG ... 16 AWG)
	flexible with plastic ferrule	0,25 ... 0,75 mm ² (24 AWG ... 19 AWG)
	flexible without wire end ferrule	0,2 ... 1,5 mm ² (24 AWG ... 16 AWG)
	rigid	0,2 ... 1,5 mm ² (24 AWG ... 16 AWG)
Stripping length		8 mm



VEO

TIME RELAY / MULTIFUNCTION TIME RELAY

V2ZM10 12-240V AC/DC

Art.Nr.: 125100

V2ZM10P 12-240V AC/DC

Art.Nr.: 125600



GENERAL DATA

MTTF	-
Weight	85 g

ISOLATION DATA

Pollution degree (IEC 61812-1)	2
Overvoltage category (IEC 61812-1)	III
Rated insulation voltage (IEC 61812-1)	supply circuit / output circuit 300 V
Rated impulse withstanding voltage (IEC 61812-1)	supply circuit / output circuit 6 kV
Insulation test voltage (IEC 61812-1)	supply circuit / output circuit 3200 V
Degree of protection	supply circuit / output circuit protective separation

STANDARDS

Product standard	IEC 61812-1
Interference immunity	IEC 61812-1 class A
Interference emission	IEC 61812-1 class A
Approvals	



FUNCTIONS

ON delay (E)

When the supply voltage U is applied, the set interval t begins (green LED U/t flashes). After the interval t has expired (green LED U/t illuminated) the output relay R switches into on-position (yellow LED illuminated). This status remains until the supply voltage is interrupted. If the supply voltage is interrupted before the expiry of the interval t, the interval already expired is erased and is restarted when the supply voltage is next applied.

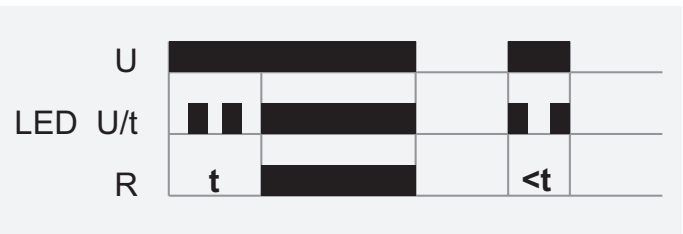

OFF delay with control input (R)

The supply voltage U must be constantly applied to the device (green LED U/t illuminated). When the control contact S is closed, the output relay R switches into on-position (yellow LED illuminated). If the control contact is opened, the set interval t begins (green LED U/t flashes). After the interval t has expired (green LED U/t illuminated) the output relay switches into off-position (yellow LED not illuminated). If the control contact is closed again before the interval t has expired, the interval already expired is erased and is restarted.

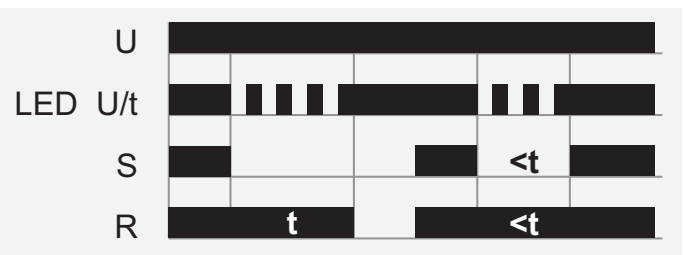

Single shot leading edge with control input (Ws)

The supply voltage U must be constantly applied to the device (green LED U/t illuminated). When the control contact S is closed, the output relay R switches into on-position (green LED U/t illuminated) and the set interval t begins (green LED U/t flashes). After the interval t has expired (green LED U/t illuminated) the output relay switches into off-position (yellow LED not illuminated). During the interval, the control contact can be operated any number of times. A further cycle can only be started when the cycle run has been completed.

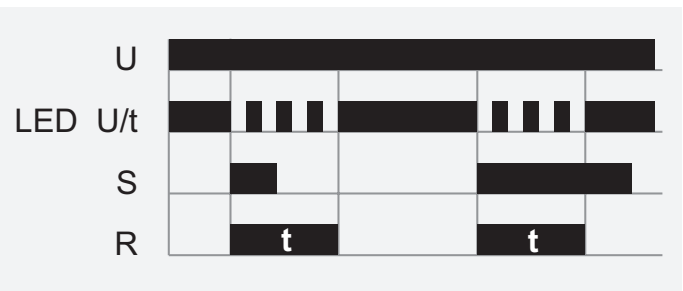

Single shot leading edge voltage controlled (Wu)

When the supply voltage U is applied, the output relay R switches into on-position (yellow LED illuminated) and the set interval t begins (green LED U/t flashes). After the interval t has expired (green LED U/t illuminated) the output relay switches into off-position (yellow LED not illuminated). This status remains until the supply voltage is interrupted. If the supply voltage is interrupted before the interval t has expired, the output relay switches into off-position. The interval already is erased and is restarted when the supply voltage is next applied.

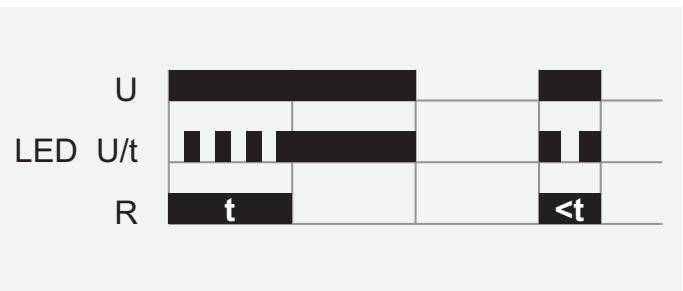

Single shot trailing edge with control input (Wa)

The supply voltage U must be constantly applied to the device (green LED U/t illuminated). Closing the control contact S has no influence on the condition of the output R. When the control contact is opened, the output relay switches into on-position (yellow LED illuminated) and the set interval t begins (green LED U/t flashes). After the interval t has expired (green LED U/t illuminated), the output relay switches into off-position (yellow LED not illuminated). During the interval, the control contact can be operated any number of times. A further cycle can only be started when the cycle run has been completed.

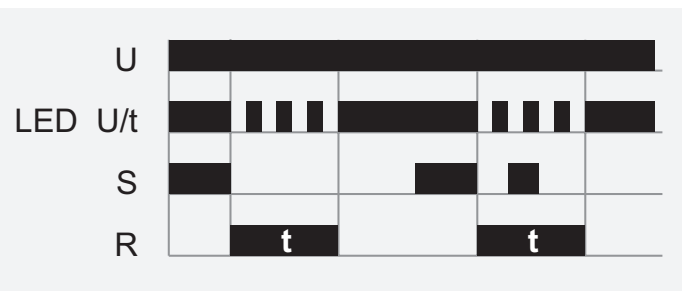



VEO

TIME RELAY / MULTIFUNCTION TIME RELAY

V2ZM10 12-240V AC/DC

Art.Nr.: 125100

V2ZM10P 12-240V AC/DC

Art.Nr.: 125600



FUNCTIONS

ON delay with control input (Es)

The supply voltage U must be constantly applied to the device (green LED U/t illuminated). When the control contact S is closed, the set interval t begins (green LED U/t flashes). After the interval t has expired (green LED U/t illuminated) the output relay R switches into on-position (yellow LED illuminated). This status remains until the control contact is opened again. If the control contact is opened before the interval t has expired, the interval already expired is erased and is restarted with the next cycle.

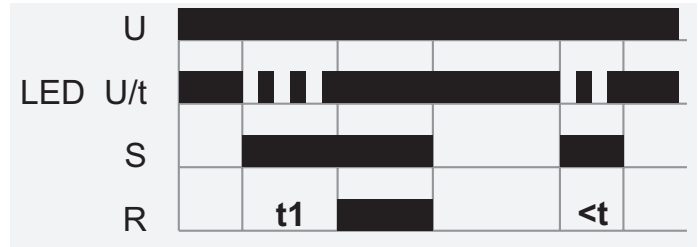

Flasher pause first (Bp)

When the supply voltage U is applied, the set interval t begins (green LED U/t flashes). After the interval t has expired, the output relay R switches into on-position (yellow LED illuminated) and the set interval t begins again. After the interval t has expired, the output relay switches into off-position (yellow LED not illuminated). The output relay is triggered at a ratio of 1:1 until the supply voltage is interrupted.

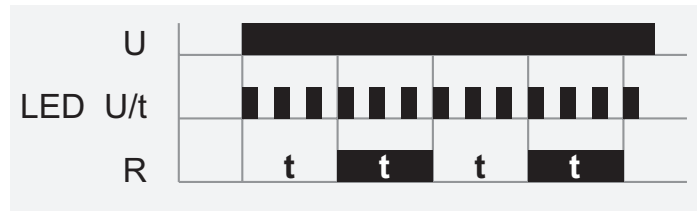

Flasher pulse first (Bi)

When the supply voltage U is applied, the output relay R switches into on-position (yellow LED illuminated) and the set interval t begins (green LED U/t flashes). After the interval t has expired, the output relay R switches into off-position (yellow LED not illuminated) and the set interval t begins again (green LED U/t flashes). The output relay is triggered at a ratio of 1:1 until the supply voltage is interrupted.

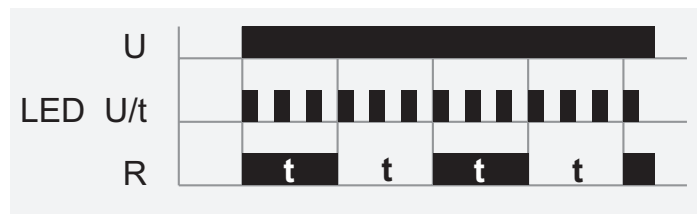

Pulse sequence monitoring (Wt)

When the supply voltage U is applied (green LED U/t illuminated), the output relay R switches into on-position (yellow LED illuminated). When the control contact S is closed, the set interval t begins (green LED U/t flashes). So that the output relay R remains in on-position, the control contact S must be opened and closed again within the set interval t . If this does not happen, the output relay R switches into off-position and all further pulses at the control contact are ignored. To restart the function the supply voltage must be interrupted and re-applied.

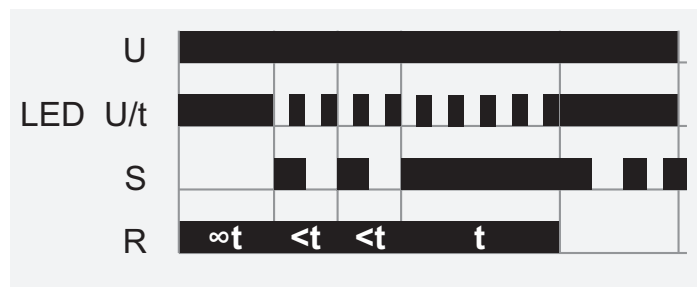

Additive ON Delay (Ec)

When the supply voltage U is applied, the release for the interval starts (green LED U/t illuminated). When the control contact S is closed, the set interval t begins (green LED U/t flashes). If the control contact S is opened during the set interval t , the interval stops (green LED U/t illuminated), and the already expired interval is stored. During the lapse of time the control contact can be opened or closed as often as required. If the sum of the periods, in which the control contact S is closed reaches the set interval t the output relay R switches into on-position (yellow LED R illuminated). The interval is stopped (green LED U/t illuminated) and a further activation of the control contact S remains without effect. By interrupting the supply voltage, the device will be reset. A possibly expired time t is deleted.

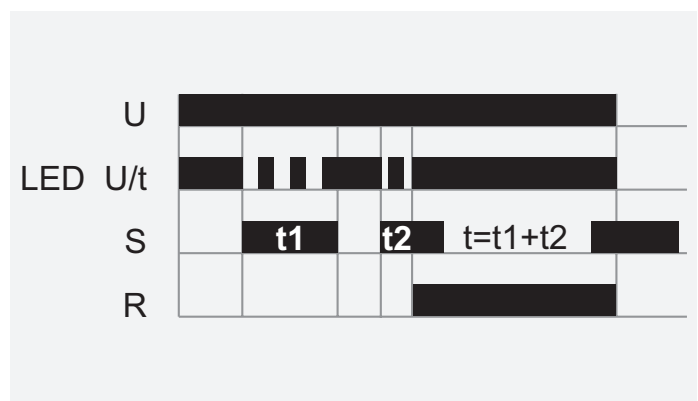



VEO

TIME RELAY / MULTIFUNCTION TIME RELAY

V2ZM10 12-240V AC/DC

Art.Nr.: 125100

V2ZM10P 12-240V AC/DC

Art.Nr.: 125600



CONNECTIONS

without control input

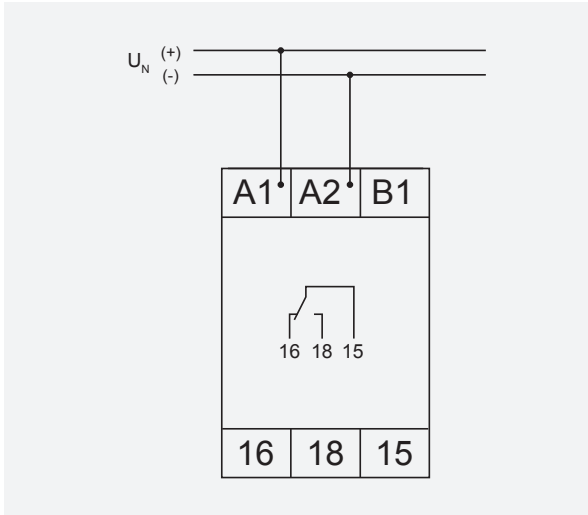

with control input

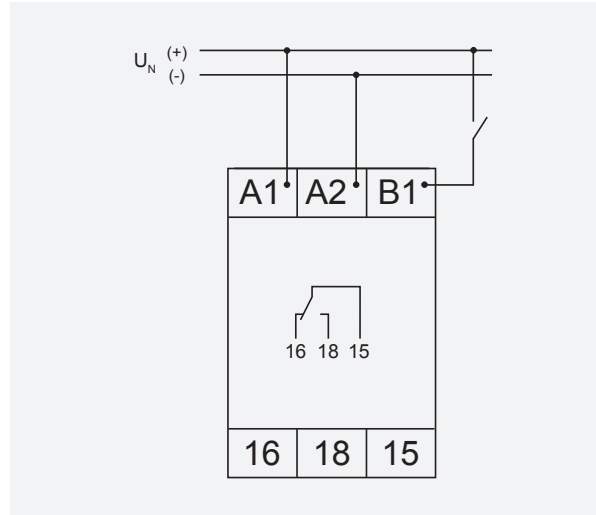



VEO

TIME RELAY / MULTIFUNCTION TIME RELAY

V2ZM10 12-240V AC/DC

Art.Nr.: 125100

V2ZM10P 12-240V AC/DC

Art.Nr.: 125600



DIMENSIONS

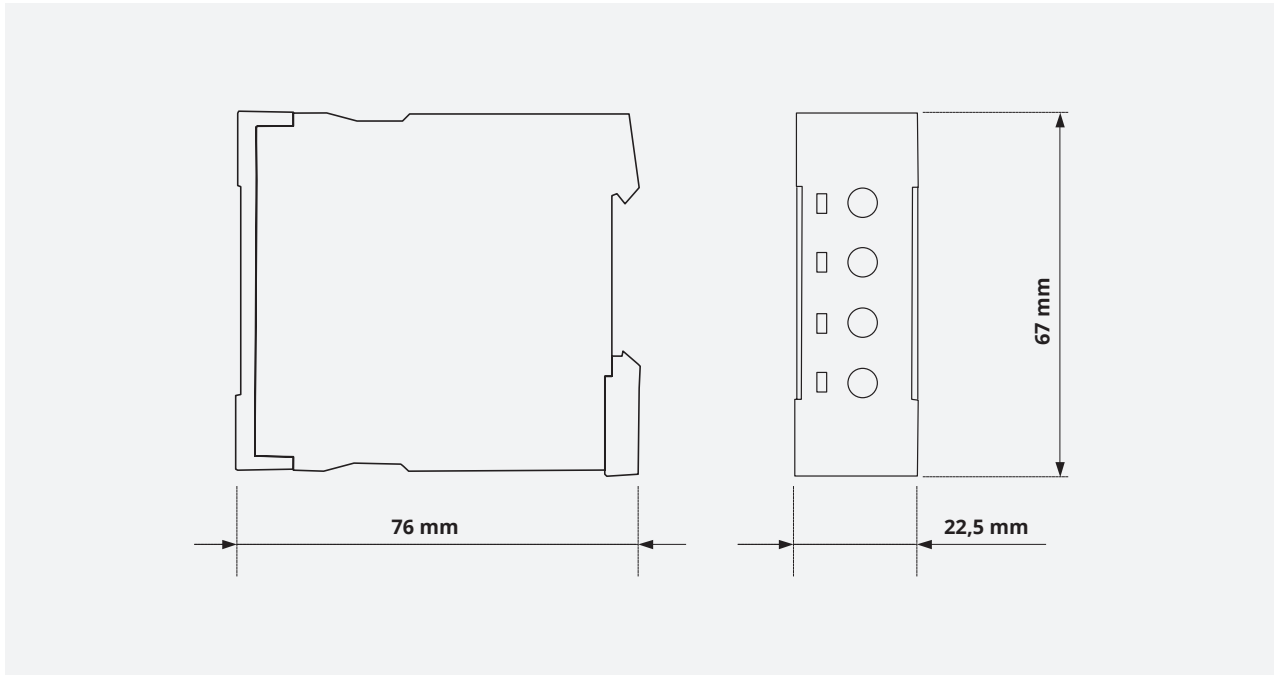

CONTACT



TELE Haase Steuergeräte Ges.m.b.H.

Vorarlberger Allee 38
1230 Vienna
Austria

CALL US



+43 / 1 / 614 74 - 0

ONLINE SUPPORT



info@tele-online.com

X-ON Electronics

Largest Supplier of Electrical and Electronic Components

Click to view similar products for [tele manufacturer](#):

Other Similar products are found below :

[G2PF400VS02](#) [G2PM400VSY20 24-240VAC/DC](#) [E1ZM10 12-240VAC/DC](#)