

12MHz, High Input Impedance Operational Amplifier

HA-2600 is an internally compensated bipolar operational amplifier that features very high input impedance (500MΩ) coupled with wideband AC performance. The high resistance of the input stage is complemented by low offset voltage (0.5mV) and low bias and offset current (1nA) to facilitate accurate signal processing. Input offset can be reduced further by means of an external nulling potentiometer. 12MHz unity gain-bandwidth, 7V/μs slew rate and 150kV/V open-loop gain enables the HA-2600 to perform high-gain amplification of fast, wideband signals. These dynamic characteristics, coupled with fast settling times, make this amplifier ideally suited to pulse amplification designs as well as high frequency (e.g. video) applications. The frequency response of the amplifier can be tailored to exact design requirements by means of an external bandwidth control capacitor.

In addition to its application in pulse and video amplifier designs, the HA-2600 is particularly suited to other high performance designs such as high-gain low distortion audio amplifiers, high-Q and wideband active filters and high-speed comparators.

Ordering Information

PART NUMBER	PART MARKING	TEMP. RANGE (°C)	PACKAGE	PKG. DWG. #
HA2-2600-2	HA2-2600-2	-55 to 125	8 Pin Metal Can	T8.C

Features

- Bandwidth 12MHz
- High Input Impedance 500MΩ
- Low Input Bias Current 1nA
- Low Input Offset Current 1nA
- Low Input Offset Voltage 0.5mV
- High Gain 150kV/V
- Slew Rate 7V/μs
- Output Short Circuit Protection
- Unity Gain Stable

Applications

- Video Amplifier
- Pulse Amplifier
- Audio Amplifiers and Filters
- High-Q Active Filters
- High-Speed Comparators
- Low Distortion Oscillators

Pinout

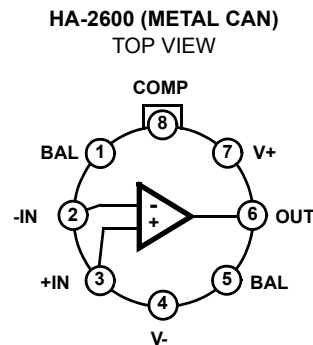

HA-2600

Absolute Maximum Ratings

Supply Voltage Between V+ and V- Terminals 45V
 Differential Input Voltage 12V
 Peak Output Current Full Short Circuit Protection

Thermal Information

Thermal Resistance (Typical, Note 1) θ_{JA} (°C/W) θ_{JC} (°C/W)
 Metal Can Package 165 80
 Maximum Junction Temperature (Hermetic Package) 175°C
 Maximum Storage Temperature Range -65°C to 150°C
 Maximum Lead Temperature (Soldering 10s) 300°C

Operating Conditions

Temperature Range
 HA-2600-2 -55°C to 125°C

CAUTION: Stresses above those listed in "Absolute Maximum Ratings" may cause permanent damage to the device. This is a stress only rating and operation of the device at these or any other conditions above those indicated in the operational sections of this specification is not implied.

NOTE:

- θ_{JA} is measured with the component mounted on a low effective thermal conductivity test board in free air. See Tech Brief TB379 for details.

Electrical Specifications $V_{SUPPLY} = \pm 15V$, Unless Otherwise Specified

PARAMETER	TEMP. (°C)	MIN	TYP	MAX	UNITS
INPUT CHARACTERISTICS					
Offset Voltage	25	-	0.5	4	mV
	Full	-	2	6	mV
Average Offset Voltage Drift	Full	-	5	-	$\mu V/^\circ C$
Bias Current	25	-	1	10	nA
	Full	-	10	30	nA
Offset Current	25	-	1	10	nA
	Full	-	5	30	nA
Differential Input Resistance (Note 11)	25	100	500	-	M Ω
Input Noise Voltage Density (f = 1kHz)	25	-	11	-	nV/ \sqrt{Hz}
Input Noise Current Density (f = 1kHz)	25	-	0.16	-	pA/ \sqrt{Hz}
Common Mode Range	Full	± 11	± 12	-	V
TRANSFER CHARACTERISTICS					
Large Signal Voltage Gain (Notes 2, 5)	25	100	150	-	kV/V
	Full	70	-	-	kV/V
Common Mode Rejection Ratio (Note 3)	Full	80	100	-	dB
Minimum Stable Gain	25	1	-	-	V/V
Gain Bandwidth Product (Note 4)	25	-	12	-	MHz
OUTPUT CHARACTERISTICS					
Output Voltage Swing (Note 2)	Full	± 10	± 12	-	V
Output Current (Note 5)	25	± 15	± 22	-	mA
Full Power Bandwidth (Notes 5, 12)	25	50	75	-	kHz
TRANSIENT RESPONSE (Note 11)					
Rise Time (Notes 2, 6, 7, 8)	25	-	30	60	ns
Overshoot (Notes 2, 6, 7, 9)	25	-	25	40	%
Slew Rate (Notes 2, 6, 8, 13)	25	± 4	± 7	-	V/ μs
Settling Time (Notes 2, 6, 14)	25	-	1.5	-	μs

Electrical Specifications $V_{SUPPLY} = \pm 15V$, Unless Otherwise Specified (Continued)

PARAMETER	TEMP. (°C)	MIN	TYP	MAX	UNITS
POWER SUPPLY CHARACTERISTICS					
Supply Current	25	-	3	3.7	mA
Power Supply Rejection Ratio (Note 10)	Full	80	90	-	dB

NOTES:

2. $R_L = 2k\Omega$.
3. $V_{CM} = \pm 10V$.
4. $V_{OUT} < 90mV$.
5. $V_{OUT} = \pm 10V$.
6. $C_L = 100pF$.
7. $V_{OUT} = \pm 200mV$.
8. $A_V = +1$.
9. See Transient Response Test Circuits and Waveforms.
10. $\Delta V_S = \pm 5V$.
11. This parameter value guaranteed by design calculations.
12. Full Power Bandwidth guaranteed by slew rate measurement: $FPBW = \frac{Slew\ Rate}{2\pi V_{PEAK}}$.
13. $V_{OUT} = \pm 5V$
14. Settling time is characterized at $A_V = -1$ to 0.1% of a 10V step.

Test Circuits and Waveforms

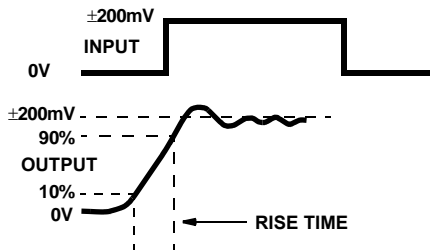

NOTE: Measured on both positive and negative transitions from 0V to +200mV and 0V to -200mV at the output.

FIGURE 1. TRANSIENT RESPONSE

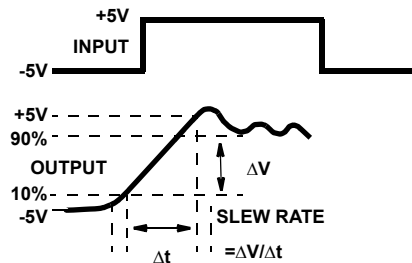

FIGURE 2. SLEW RATE

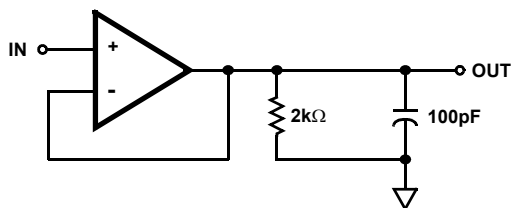
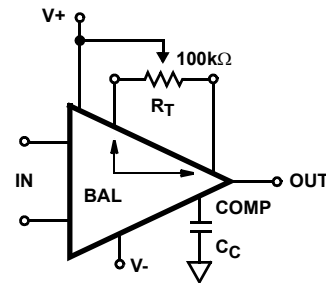

FIGURE 3. SLEW RATE AND TRANSIENT RESPONSE TEST CIRCUIT



NOTE: Tested offset adjustment range is $|V_{OS} + 1mV|$ minimum referred to output. Typical ranges are $\pm 10mV$ with $R_T = 100k\Omega$.

FIGURE 4. SUGGESTED V_{OS} ADJUSTMENT AND COMPENSATION HOOK UP

Schematic Diagram

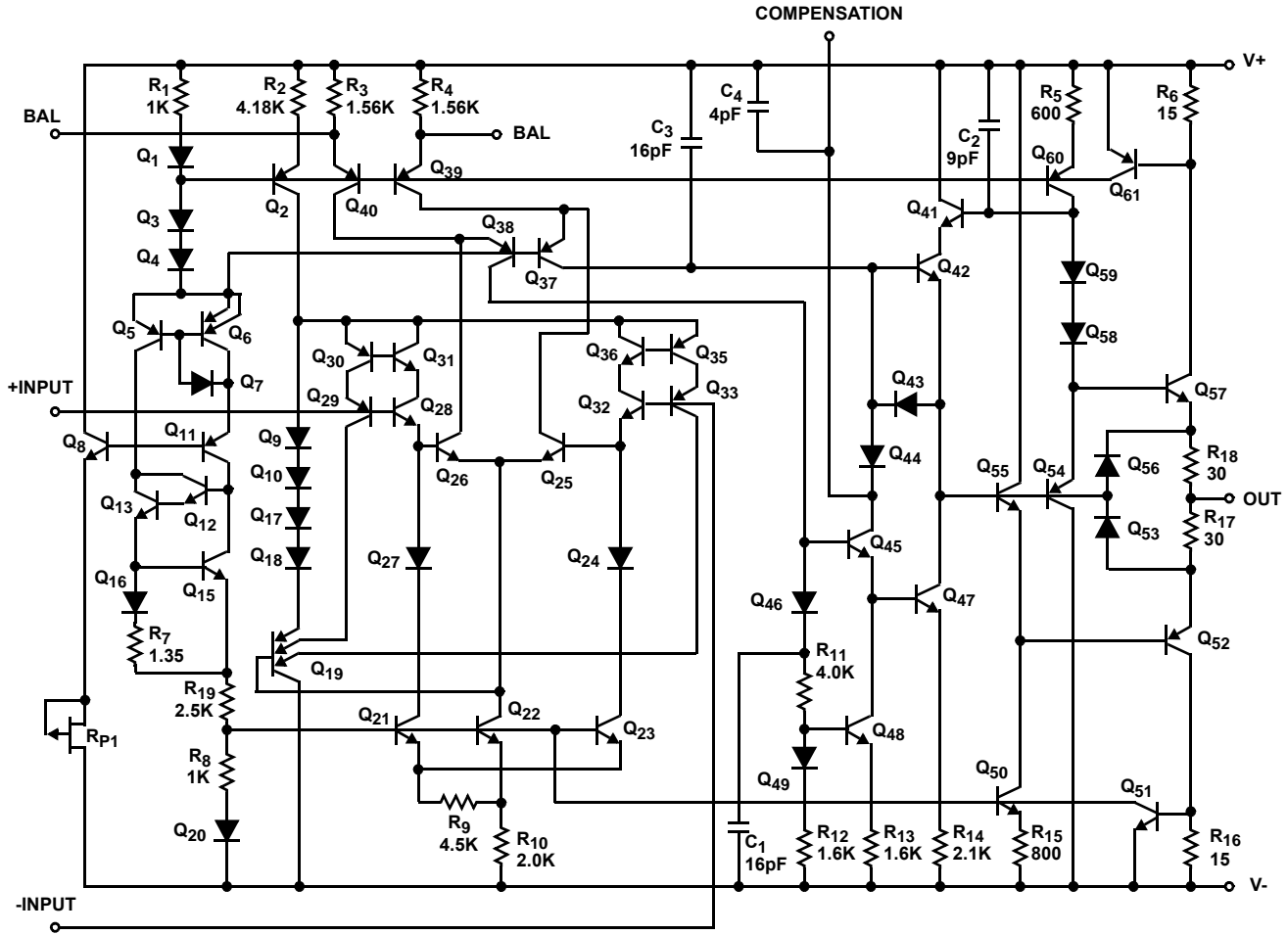

Typical Applications

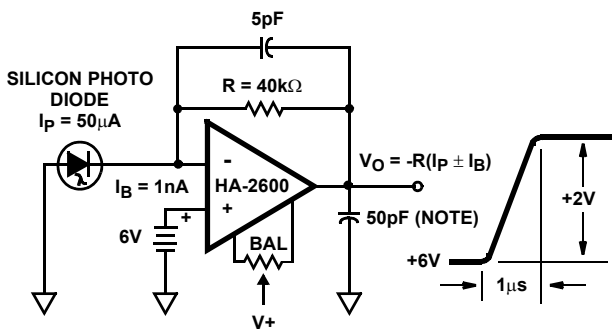

- FEATURES:
1. Constant cell voltage.
 2. Minimum bias current error.

NOTE: A small load capacitance is recommended in all applications where practical to prevent possible high frequency oscillations resulting from external wiring parasitics. Capacitance up to 100pF has negligible effect on the bandwidth or slew rate.

FIGURE 5. PHOTO CURRENT TO VOLTAGE CONVERTER

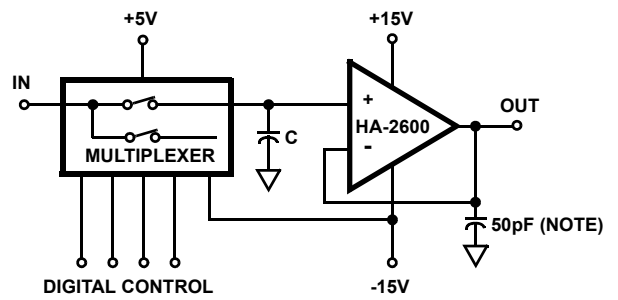

$$\text{DRIFT RATE} = \frac{I_{\text{BIAS}}}{C}$$

If C = 1000pF
Then DRIFT = 0.01V/μs (Max)

FIGURE 6. SAMPLE AND HOLD

Typical Applications (Continued)

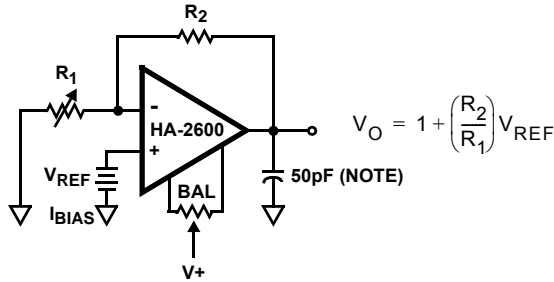

$$V_O = 1 + \left(\frac{R_2}{R_1}\right)V_{REF}$$

FEATURES:

1. Minimum bias current in reference cell.
2. Short Circuit Protection.

NOTE: A small load capacitance is recommended in all applications where practical to prevent possible high frequency oscillations resulting from external wiring parasitics. Capacitance up to 100pF has negligible effect on the bandwidth or slew rate.

FIGURE 7. REFERENCE VOLTAGE AMPLIFIER

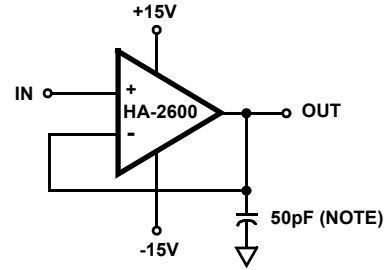

FEATURES

1. $Z_{IN} = 10^{12}\Omega$ (Min).
2. $Z_{OUT} = 0.01\Omega$ (Max), B.W. = 12MHz (Typ).
3. Slew Rate = 4V/ μ s (Min), Output Swing = $\pm 10V$ (Min) to 50kHz.

FIGURE 8. VOLTAGE FOLLOWER

Typical Performance Curves $V_S = \pm 15V, T_A = 25^\circ C$, Unless Otherwise Specified

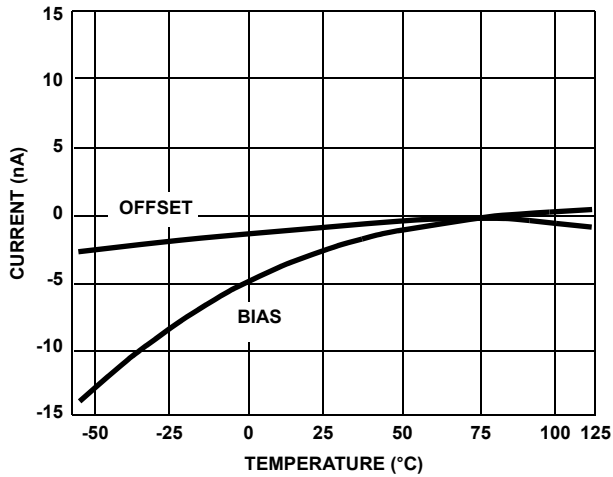

FIGURE 9. INPUT BIAS CURRENT AND OFFSET CURRENT vs TEMPERATURE

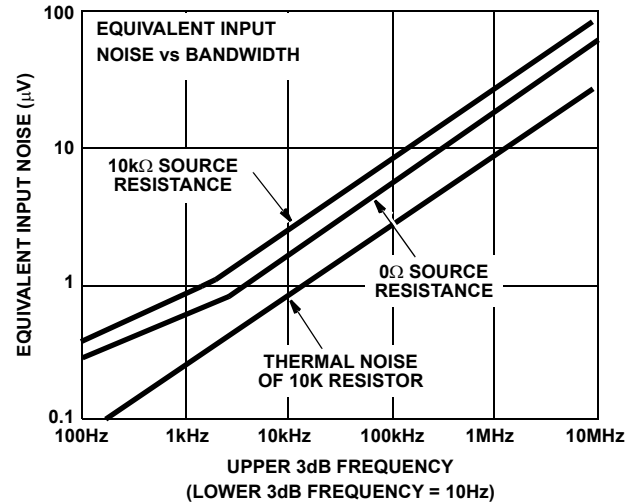

FIGURE 10. BROADBAND NOISE CHARACTERISTICS (LOWER 3dB FREQUENCY = 10Hz)

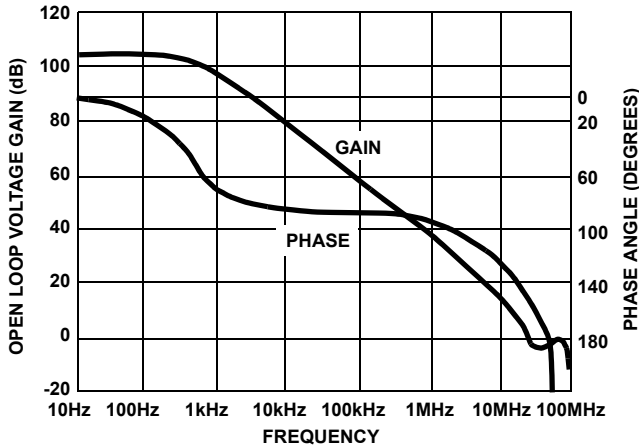

FIGURE 11. OPEN LOOP FREQUENCY RESPONSE

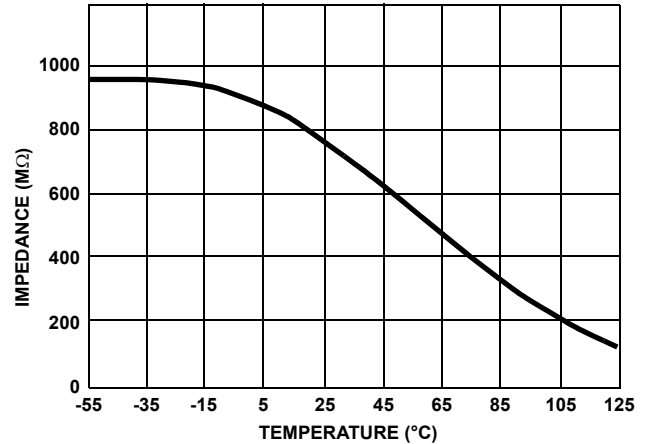

FIGURE 12. INPUT IMPEDANCE vs TEMPERATURE (100Hz)

Typical Performance Curves $V_S = \pm 15V$, $T_A = 25^\circ C$, Unless Otherwise Specified (Continued)

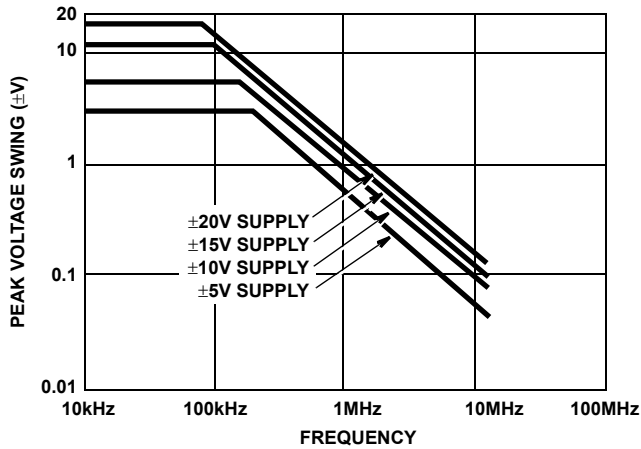
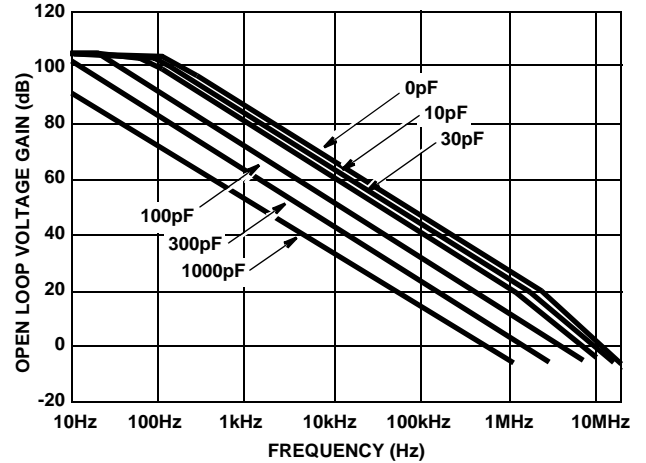

FIGURE 13. OUTPUT VOLTAGE SWING vs FREQUENCY



- External compensation components are not required for stability, but may be added to reduce bandwidth if desired. If External Compensation is used, also connect 100pF capacitor from output to ground.

FIGURE 14. OPEN LOOP FREQUENCY RESPONSE FOR VARIOUS VALUES OF CAPACITORS FROM COMPENSATION PIN TO GROUND

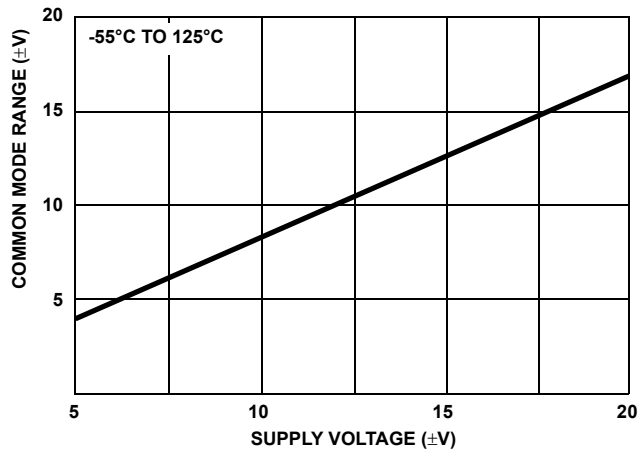

FIGURE 15. COMMON MODE VOLTAGE RANGE vs SUPPLY VOLTAGE

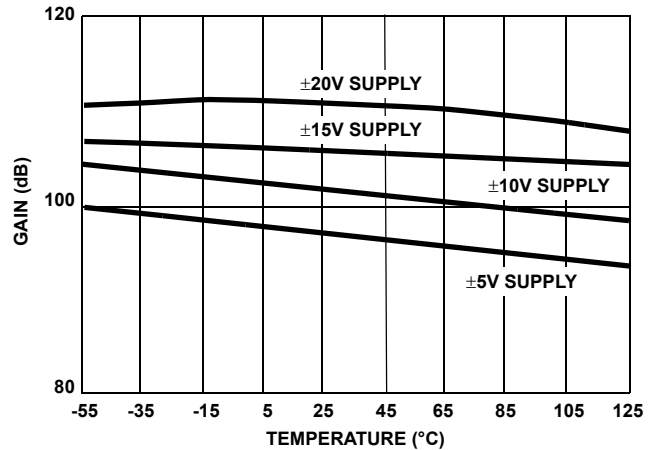

FIGURE 16. OPEN LOOP VOLTAGE GAIN vs TEMPERATURE

Typical Performance Curves $V_S = \pm 15V$, $T_A = 25^\circ C$, Unless Otherwise Specified (Continued)

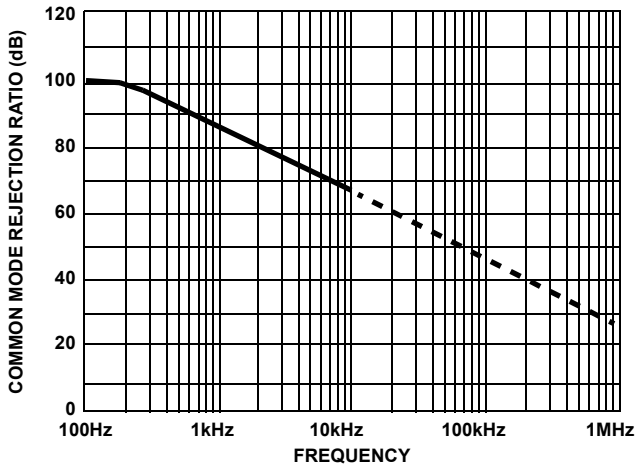

FIGURE 17. COMMON MODE REJECTION RATIO vs FREQUENCY

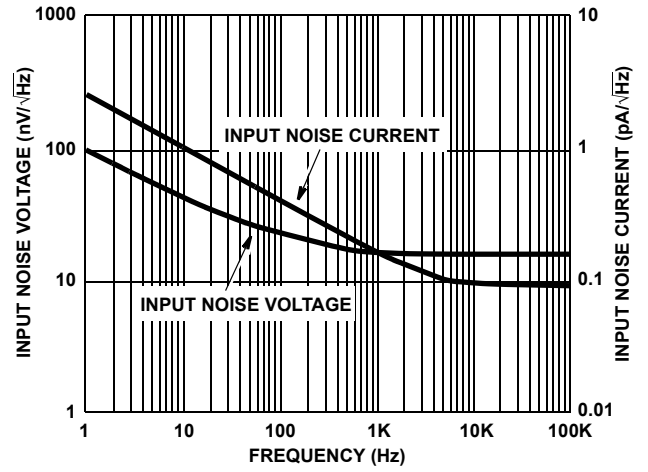

FIGURE 18. NOISE DENSITY vs FREQUENCY

HA-2600

Die Characteristics

SUBSTRATE POTENTIAL (Powered Up):

Unbiased

PROCESS:

Bipolar Dielectric Isolation

TRANSISTOR COUNT:

140

Metallization Mask Layout

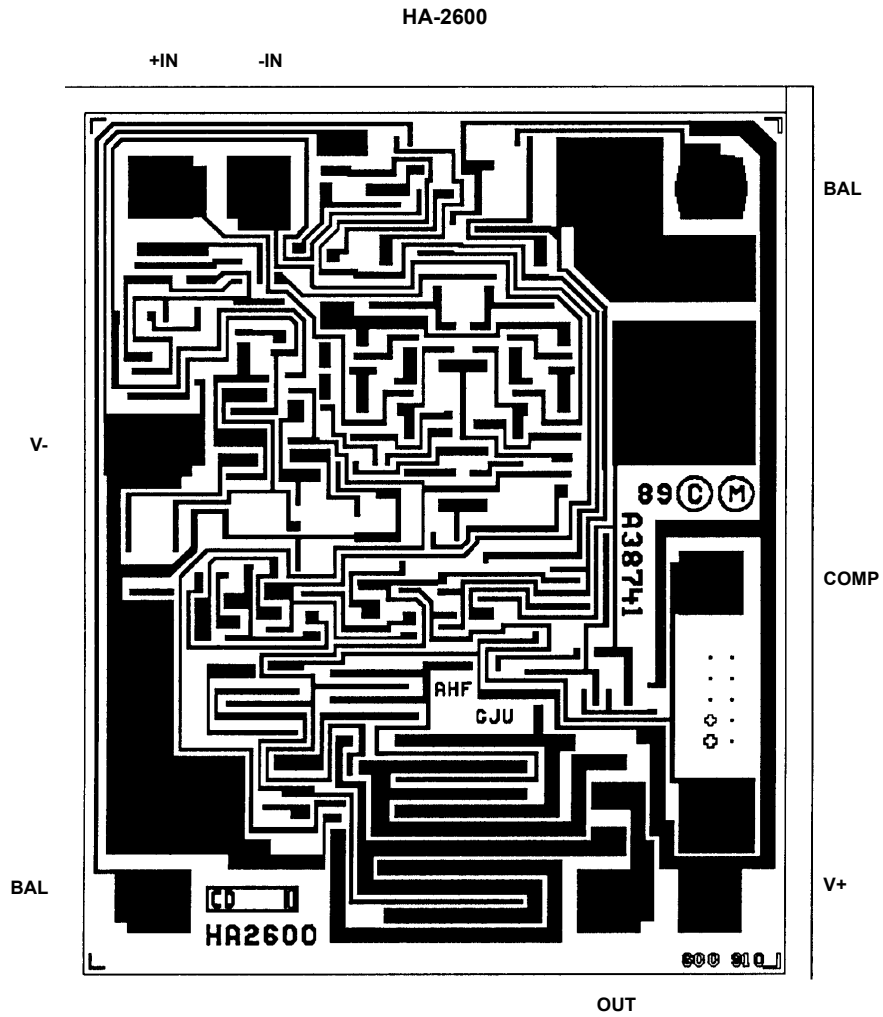

Metal Can Packages (Can)

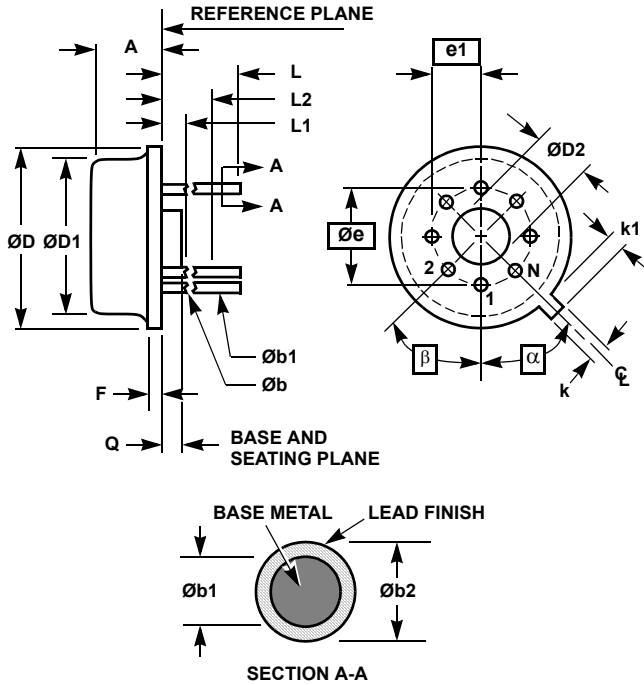

**T8.C MIL-STD-1835 MACY1-X8 (A1)
8 LEAD METAL CAN PACKAGE**

SYMBOL	INCHES		MILLIMETERS		NOTES
	MIN	MAX	MIN	MAX	
A	0.165	0.185	4.19	4.70	-
Øb	0.016	0.019	0.41	0.48	1
Øb1	0.016	0.021	0.41	0.53	1
Øb2	0.016	0.024	0.41	0.61	-
ØD	0.335	0.375	8.51	9.40	-
ØD1	0.305	0.335	7.75	8.51	-
ØD2	0.110	0.160	2.79	4.06	-
e	0.200 BSC		5.08 BSC		-
e1	0.100 BSC		2.54 BSC		-
F	-	0.040	-	1.02	-
k	0.027	0.034	0.69	0.86	-
k1	0.027	0.045	0.69	1.14	2
L	0.500	0.750	12.70	19.05	1
L1	-	0.050	-	1.27	1
L2	0.250	-	6.35	-	1
Q	0.010	0.045	0.25	1.14	-
α	45° BSC		45° BSC		3
β	45° BSC		45° BSC		3
N	8		8		4

Rev. 0 5/18/94

NOTES:

- (All leads) Øb applies between L1 and L2. Øb1 applies between L2 and 0.500 from the reference plane. Diameter is uncontrolled in L1 and beyond 0.500 from the reference plane.
- Measured from maximum diameter of the product.
- α is the basic spacing from the centerline of the tab to terminal 1 and β is the basic spacing of each lead or lead position (N - 1 places) from α, looking at the bottom of the package.
- N is the maximum number of terminal positions.
- Dimensioning and tolerancing per ANSI Y14.5M - 1982.
- Controlling dimension: INCH.

All Intersil U.S. products are manufactured, assembled and tested utilizing ISO9000 quality systems. Intersil Corporation's quality certifications can be viewed at www.intersil.com/design/quality

Intersil products are sold by description only. Intersil Corporation reserves the right to make changes in circuit design, software and/or specifications at any time without notice. Accordingly, the reader is cautioned to verify that data sheets are current before placing orders. Information furnished by Intersil is believed to be accurate and reliable. However, no responsibility is assumed by Intersil or its subsidiaries for its use; nor for any infringements of patents or other rights of third parties which may result from its use. No license is granted by implication or otherwise under any patent or patent rights of Intersil or its subsidiaries.

For information regarding Intersil Corporation and its products, see www.intersil.com

X-ON Electronics

Largest Supplier of Electrical and Electronic Components

Click to view similar products for [Operational Amplifiers - Op Amps](#) category:

Click to view products by [Renesas](#) manufacturer:

Other Similar products are found below :

[OPA2991IDSGR](#) [OPA607IDCKT](#) [007614D](#) [633773R](#) [635798C](#) [635801A](#) [702115D](#) [709228FB](#) [741528D](#) [NCV33072ADR2G](#)
[SC2902DTBR2G](#) [SC2903DR2G](#) [SC2903VDR2G](#) [LM258AYDT](#) [LM358SNG](#) [430227FB](#) [430228DB](#) [460932C](#) [AZV831KTR-G1](#) [409256CB](#)
[430232AB](#) [LM2904DR2GH](#) [LM358YDT](#) [LT1678IS8](#) [042225DB](#) [058184EB](#) [070530X](#) [SC224DR2G](#) [SC239DR2G](#) [SC2902DG](#)
[SCYA5230DR2G](#) [714228XB](#) [714846BB](#) [873836HB](#) [MIC918YC5-TR](#) [TS912BIYDT](#) [NCS2004MUTAG](#) [NCV33202DMR2G](#)
[M38510/13101BPA](#) [NTE925](#) [SC2904DR2G](#) [SC358DR2G](#) [LM358EDR2G](#) [AZV358MTR-G1](#) [AP4310AUMTR-AG1](#) [HA1630D02MMEL-E](#)
[NJM358CG-TE2](#) [HA1630S01LPEL-E](#) [LM324AWPT](#) [HA1630Q06TELL-E](#)