

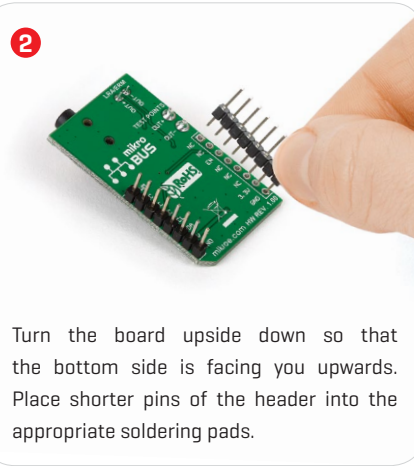

## HAPTIC click

### 2. Soldering the headers

Before using your click board™, make sure to solder 1x8 male headers to both left and right side of the board. Two 1x8 male headers are included with the board in the package.

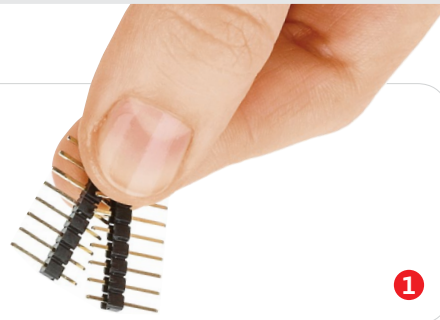

Turn the board upside down so that the bottom side is facing you upwards. Place shorter pins of the header into the appropriate soldering pads.

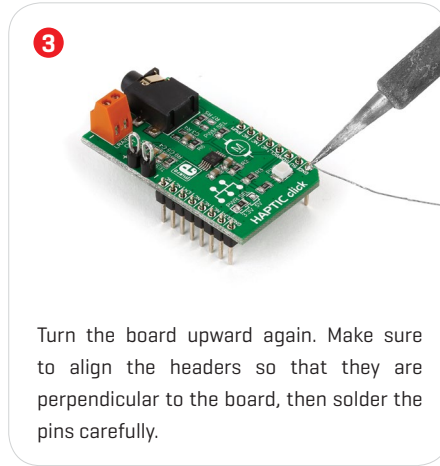

Turn the board upward again. Make sure to align the headers so that they are perpendicular to the board, then solder the pins carefully.

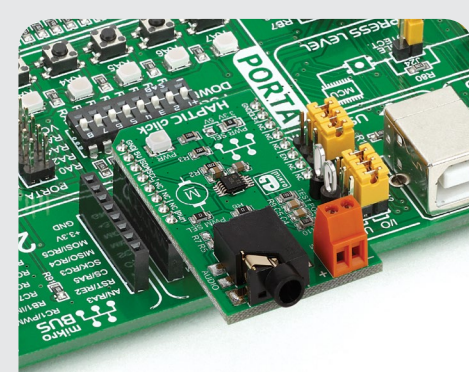

### 4. Essential features

The DRV2605 IC integrates an extensive library with over 100 haptic effects. These include audio-to-vibe features, which generate vibrations from the lower frequency range of the audio input (licensed version of TouchSense® 2200 effects from Immersion™). A real-time playback mode allows the host MCU to bypass the effects and send waveforms to the motor directly through I2C pins. This board is ideal for enhancing User Interface designs with the addition of tactile feedback. Applications include touch-enabled devices, remote controls as well as wearables.

### 1. Introduction

Haptic click carries DRV2605, a Haptic Driver for ERM and LRA vibration motors (acronyms stand for Eccentric Rotating Mass and Linear Resonant Actuator, respectively). The board also carries screw terminals for connecting said motors, as well as an audio interface (3.5mm jack). Haptic click communicates with the target MCU through mikroBUS™ I2C (SCL, SDA), EN (in place of CS) and PWM pins. The board is designed to use either a 3.3V or 5V power supply.

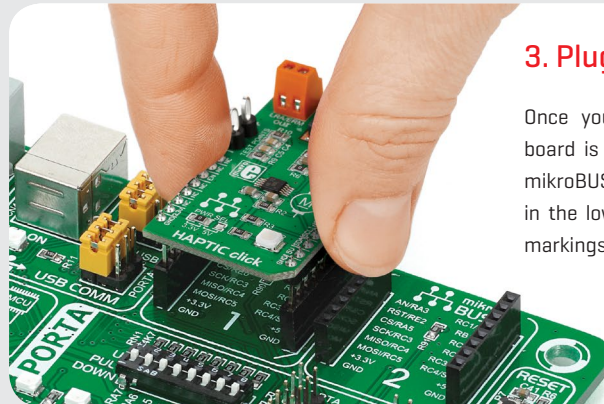

### 3. Plugging the board in

Once you have soldered the headers your board is ready to be placed into the desired mikroBUS™ socket. Make sure to align the cut in the lower-right part of the board with the markings on the silkscreen at the mikroBUS™ socket. If all the pins are aligned correctly, push the board all the way into the socket.



HAPTIC click Manual v1.01



010000090022

## 5. Schematic

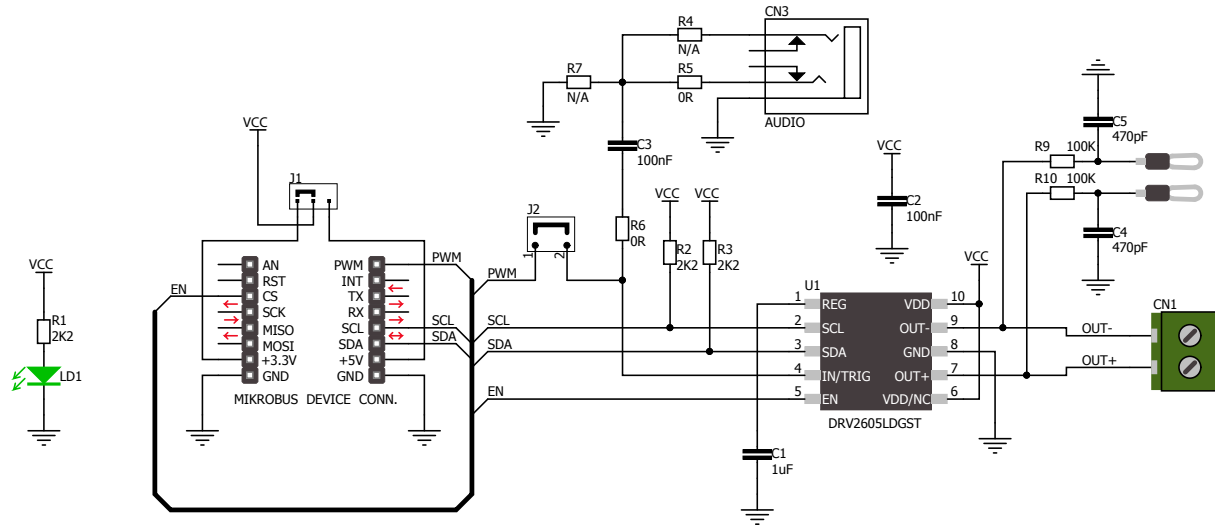

## 6. Dimensions

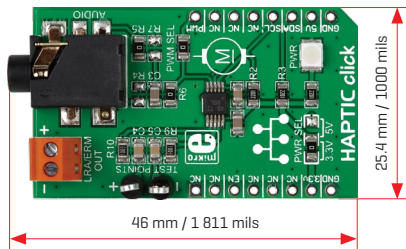

	mm	mils
LENGTH	46	1811
WIDTH	25.4	1000
HEIGHT*	3.9	154

\* without headers

## 7. SMD jumpers

Haptic click features an SMD jumper [zero ohm resistor] that let's you switch between a 3.3V or a 5V power supply. Another pair of jumpers (**R4** and **R5**) are for switching between left and right audio channels [soldered on **R5** for right channel by default]. The PWM SEL jumper disables the PWM trigger when unsoldered [thus avoiding potential interference with audio input].

## 8. Code examples

Once you have done all the necessary preparations, it's time to get your click board™ up and running. We have provided examples for mikroC™, mikroBasic™ and mikroPascal™ compilers on our **Libstock** website. Just download them and you are ready to start.



## 9. Support

MikroElektronika offers **free tech support** [[www.mikroe.com/support](http://www.mikroe.com/support)] until the end of the product's lifetime, so if something goes wrong, we're ready and willing to help!



## 10. Disclaimer

MikroElektronika assumes no responsibility or liability for any errors or inaccuracies that may appear in the present document. Specification and information contained in the present schematic are subject to change at any time without notice.

Copyright © 2015 MikroElektronika.  
All rights reserved.

## X-ON Electronics

Largest Supplier of Electrical and Electronic Components

*Click to view similar products for [Development Boards & Kits - Wireless](#) category:*

*Click to view products by [MikroElektronika](#) manufacturer:*

Other Similar products are found below :

[13237ADC-SFTW](#) [13237ADC-BDM](#) [SLWRB4542B](#) [SLWRB4546A](#) [CC-WMX51-LX](#) [TWR-13237](#) [TWR-13237-KIT](#) [109110001](#)  
[DA14585-00VVDB-P](#) [MKR MOTOR CARRIER](#) [AC164159](#) [RD-88MW322-R0](#) [RD-88MW320-R0](#) [FMC PCAM ADAPTER](#) [BLE 4 CLICK](#)  
[C METER CLICK](#) [HALL CURRENT CLICK](#) [COLOR 3 CLICK](#) [COMPASS 2 CLICK](#) [COMPASS CLICK](#) [HDC1000 CLICK](#) [RELAY](#)  
[CLICK](#) [RIVERDI CLICK](#) [CUGSM113#UFL](#) [R METER CLICK](#) [MATRIX G CLICK](#) [MATRIX RGB CLICK](#) [3D MOTION CLICK](#) [3G](#)  
[SARA CLICK](#) [TDGL012](#) [4-20MA R CLICK](#) [4-20MA T CLICK](#) [THERMO CLICK](#) [MCP2003B CLICK](#) [EXPAND 3 CLICK](#) [MCP2542](#)  
[CLICK](#) [MCP25625 CLICK](#) [ATA663211 CLICK](#) [ATA8520-EK3-E](#) [TOUCHKEY CLICK](#) [MICROSD CLICK](#) [TRF CLICK](#) [BUTTON R](#)  
[CLICK](#) [IR ECLIPSE CLICK](#) [IR THERMO 2 CLICK](#) [UNIQUE ID CLICK](#) [UV 2 CLICK](#) [CAN-SPI CLICK 3.3V](#) [CAN-SPI CLICK 5V](#) [CAP](#)  
[EXTEND CLICK](#)