

Screw and gasket,
see sheet 2, PN Key

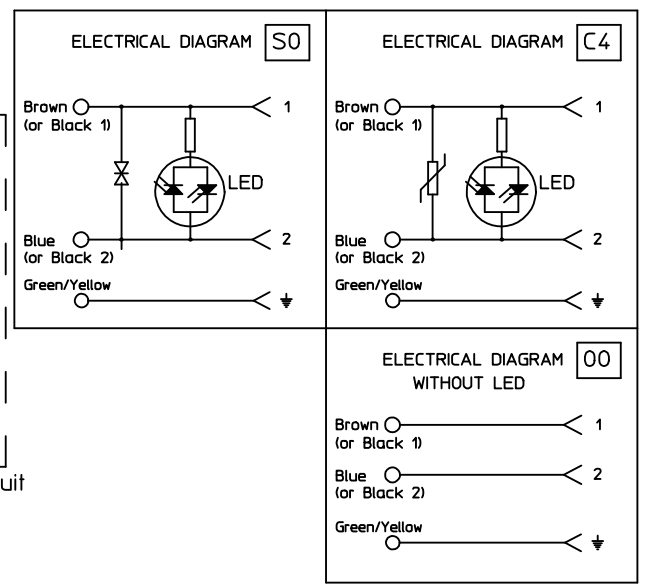
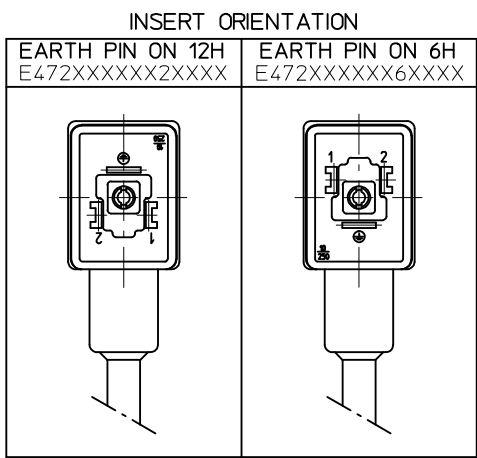
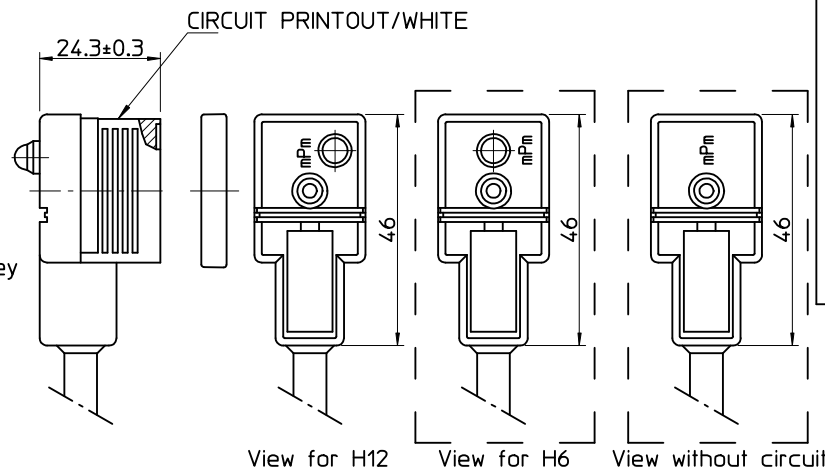

Table of length tolerances [mm]

Over	Up to and including	Tolerance (+)
0	1000	±20
1000	3000	±30
3000	5000	±40
5000	10000	±50
10000	15000	±100
15000	20000	±150
20000		±L/100

DRAWING UPDATE EC NO: IPG2013-1497 DRW: JMARSZALEK 2013/03/27 CHK: MDYSZEWSKA 2013/03/27 APPR: MIWASIECZKO 2013/03/28	QUALITY SYMBOLS 	GENERAL TOLERANCES (UNLESS SPECIFIED)		DIMENSION STYLE MM ONLY		SCALE	DESIGN UNITS	FIRST ANGLE PROJECTION
		mm	INCH	DRAWN BY	DATE	TITLE	METRIC	
REV B	DESCRIPTION	4 PLACES	±---	±---	JMARSZALEK	2012/11/19	E472XXXXXXXXXXXX FORM B EN 175301-803 molex DOCUMENT NO. SD-121050-005 SHEET NO. 1 OF 4	
		3 PLACES	±---	±---	CHECKED BY	DATE		
		2 PLACES	±---	±---	MSZWAJKOWSKI	2012/11/20		
		1 PLACE	±---	±---	APPROVED BY	DATE		
		0 PLACE	±---	±---	MIWASIECZKO	2013/02/12		
DRAFT WHERE APPLICABLE MUST REMAIN WITHIN DIMENSIONS		ANGULAR ±---°		MATERIAL NO.		SEE SHEET 2&3		
THIS DRAWING CONTAINS INFORMATION THAT IS PROPRIETARY TO MOLEX INCORPORATED AND SHOULD NOT BE USED WITHOUT WRITTEN PERMISSION		SIZE A3						

10 | 9 | 8 | 7 | 6 | 5 | 4 | 3 | 2 | 1

F

F

E

E

D

D

C

C



B

B

A

A

9 | 8 | 7 | 6 | 5 | 4 | 3 | 2 | 1

DRAWING UPDATE EC NO: IPG2013-1497 DRWN: JMARSZALEK 2013/03/27 CHKD: MDYSZEWSKA 2013/03/27 APPR: MIWASIECZKO 2013/03/28	DESCRIPTION REV	QUALITY SYMBOLS  =0  =0	GENERAL TOLERANCES (UNLESS SPECIFIED)		DIMENSION STYLE MM ONLY		SCALE 1:1	DESIGN UNITS METRIC	 FIRST ANGLE PROJECTION	
		4 PLACES ± --- ± --- 3 PLACES ± --- ± --- 2 PLACES ± --- ± --- 1 PLACE ± --- ± --- 0 PLACE ± --- ± --- ANGULAR ± --- °	mm INCH	DRAWN BY DATE JMARSZALEK 2012/11/19 CHECKED BY DATE MSZWAJKOWSKI 2012/11/20 APPROVED BY DATE MIWASIECZKO 2013/02/12	TITLE E472XXXXXXXXXXXX FORM B EN 175301-803		MATERIAL NO. SEE SHEET 2&4		DOCUMENT NO. SD-121050-005	SHEET NO. 2 OF 4
DRAFT WHERE APPLICABLE MUST REMAIN WITHIN DIMENSIONS			THIS DRAWING CONTAINS INFORMATION THAT IS PROPRIETARY TO MOLEX INCORPORATED AND SHOULD NOT BE USED WITHOUT WRITTEN PERMISSION							



10 9 8 7 6 5 4 3 2 1

F

F

E

E

D

D

C



C

B

B

A

A

DRAWING UPDATE EC NO: IPG2013-1497 DRWN: JMARSZALEK 2013/03/27 CHKD: MDYSZEWSKA 2013/03/27 APPR: MIWASIECZKO 2013/03/28	DESCRIPTION REV	QUALITY SYMBOLS  = 0  = 0.1	GENERAL TOLERANCES (UNLESS SPECIFIED)		DIMENSION STYLE MM ONLY		SCALE 1:1	DESIGN UNITS METRIC	 FIRST ANGLE PROJECTION	
		4 PLACES ± --- ± --- 3 PLACES ± --- ± --- 2 PLACES ± --- ± --- 1 PLACE ± --- ± --- 0 PLACE ± --- ± --- ANGULAR ± --- °	mm INCH	DRAWN BY DATE JMARSZALEK 2012/11/19 CHECKED BY DATE MSZWAJKOWSKI 2012/11/20 APPROVED BY DATE MIWASIECZKO 2013/02/12	TITLE E472XXXXXXXXXXXX FORM B EN 175301-803		MATERIAL NO. SEE SHEET 2&4		DOCUMENT NO. SD-121050-005	SHEET NO. 3 OF 4
DRAFT WHERE APPLICABLE MUST REMAIN WITHIN DIMENSIONS			THIS DRAWING CONTAINS INFORMATION THAT IS PROPRIETARY TO MOLEX INCORPORATED AND SHOULD NOT BE USED WITHOUT WRITTEN PERMISSION							

9 8 7 6 5 4 3 2 1

10 | 9 | 8 | 7 | 6 | 5 | 4 | 3 | 2 | 1

F

F

E

E

D

D

C

C

B

B

A

A

9 | 8 | 7 | 6 | 5 | 4 | 3 | 2 | 1

DRAWING UPDATE EC NO: IPG2013-1497 DRWN: JMARSZALEK 2013/03/27 CHKD: MDYSZEWSKA 2013/03/27 APPR: MIWASIECZKO 2013/03/28	DESCRIPTION REV	QUALITY SYMBOLS		GENERAL TOLERANCES (UNLESS SPECIFIED)		DIMENSION STYLE MM ONLY		SCALE 1:1	DESIGN UNITS METRIC	FIRST ANGLE PROJECTION			
		= 0 = 0		mm	INCH	DRAWN BY	DATE	TITLE E472XXXXXXXXXXXX FORM B EN 175301-803					
			4 PLACES	± ---	± ---	JMARSZALEK	2012/11/19						
			3 PLACES	± ---	± ---	CHECKED BY	DATE						
			2 PLACES	± ---	± ---	MSZWAJKOWSKI	2012/11/20						
1 PLACE	± ---	± ---	APPROVED BY	DATE	DOCUMENT NO. SD-121050-005 SHEET NO. 4 OF 4								
0 PLACE	± ---	± ---	MIWASIECZKO	2013/02/12									
ANGULAR ± --- °		DRAFT WHERE APPLICABLE MUST REMAIN WITHIN DIMENSIONS		MATERIAL NO.		SEE SHEET 2&4 THIS DRAWING CONTAINS INFORMATION THAT IS PROPRIETARY TO MOLEX INCORPORATED AND SHOULD NOT BE USED WITHOUT WRITTEN PERMISSION							



X-ON Electronics

Largest Supplier of Electrical and Electronic Components

Click to view similar products for [Screws & Fasteners](#) category:

Click to view products by [Molex](#) manufacturer:

Other Similar products are found below :

[5721-1440-1/4-SS](#) [593503FX](#) [0098.0094](#) [0098.9206](#) [0098.9219](#) [0098.9221](#) [0098.9262](#) [596-2114-013](#) [59781-4](#) [59781-6](#) [0098.0026](#)
[0098.9210](#) [0098.9212](#) [60227-01](#) [60227-04](#) [60227-08](#) [60228-09](#) [618-00001](#) [62153-03](#) [62153-11](#) [M316-KSSTMCZ100](#) [M3440-SS](#) [M3442-SS](#) [M3448-SS](#) [6291A](#) [6292-1](#) [6-306105-9](#) [6-306131-4](#) [690432-1](#) [699161-000](#) [700989](#) [7-18023-1](#) [7-21002-8](#) [7230-3](#) [7235-3](#) [7248-1](#) [7248-2](#)
[73542-02](#) [CAPTIVE SHORT THUMBSCREW](#) [745564-1](#) [748174-2](#) [F03-02](#) [SUS316](#) [F1209](#) [751-00001](#) [80011](#) [809704-1](#) [8700](#) [8860220](#)
[9047](#) [95000002B](#) [9885-2](#)