











# TIPS

## RTW TIP SETS FOR WMRT SOLDERING TWEEZER





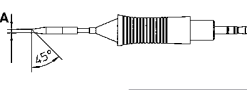
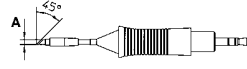
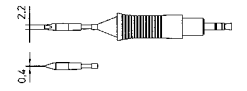
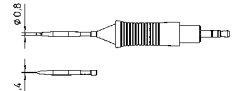
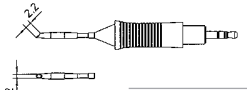
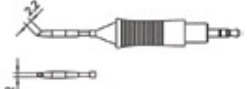

	Model	Description	Dimensions	Order No.
	RTW1	Conical	0.4 mm / .016" 45°	0054465199
	RTW2	Conical	0.7 x 0.4 mm .028" x .016" 45°	0054465299
	RTW3	Blade	3.0 x 1.0 mm .118" x .040" 45°	0054465399
	RTW4	Blade	6.0 x 1.0 mm .236" x .040" 45°	0054465499

## RT SERIES TIPS FOR WMRP MICRO SOLDERING PENCIL

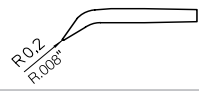



	Model	Description	Width A	Thickness B	Order No.
	RT1	Needle tip	0.2 mm / .008"	–	0054460199
	RT1SC	Micro Chisel tip	0.4mm / .016"	0.15 mm / .006"	0054461299
	RT2	Point tip	Ø 0.8 mm .032"	–	0054460299
	RT3	Chisel shape, straight	1.3 mm .051"	0.4 mm .0157"	0054460399
	RT4	Chisel shape, straight	1.5 mm .059"	0.4 mm .0157"	0054460499
	RT5	Chisel shape, bent, 30°	0.8 mm .032"	0.4 mm .0157"	0054460599
	RT6	Round shape, beveled, 45°	Ø 1.2 mm .047"	–	0054460699
	RT7	Knife tip, 45°	2.2 mm .0866"	–	0054460799
	RT8	Chisel tip, straight	2.2 mm .087"	0.4 mm .016"	0054460899
	RT9	Chisel tip, straight	0.8 mm .032"	0.4 mm .016"	0054460999
	RT10	Gull wing for drag soldering	1.2 mm .047"	2.0 mm .079"	0054461099
	RT11	Chisel Tip	3.6 mm .142"	0.9 mm .035"	0054461199

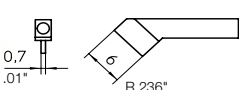

**RTWMS SERIES MIL SPEC TIP SETS FOR WMRMS MIL SPEC MICRO TWEEZER**

		Model	Description	Dimensions		Order No.
		RTW1MS	Conical	0.4 mm / .016"	45°	0054465599
		RTW2MS	Conical	0.7 x 0.4 mm .028" x .016"	45°	0054465799
		RTW3MS	Blade	3.0 x 1.0 mm .118" x .040"	45°	0054465899
		RTW4MS	Blade	6.0 x 1.0 mm .236" x .040"	45°	0054465999

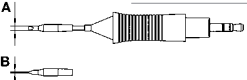
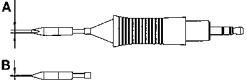
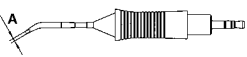
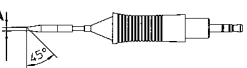
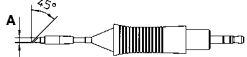
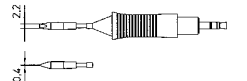
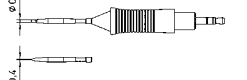
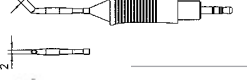
**RT SERIES MIL SPEC TIPS FOR WMRPMS MIL SPEC MICRO SOLDERING PENCIL**

	Model	Description	Width A	Thickness B	Order No.
	RT1MS TIP	Needle tip	0.2 mm / .008"	-	0054461499
	RT1SCMS TIP	Micro Chisel tip	0.4mm / .016"	0.15 mm / .006"	0055461599
	RT2MS TIP	Point tip	Ø 0.8 mm .032"	-	0055461799
	RT3MS TIP	Chisel shape, straight	1.3 mm .051"	0.4 mm .0157"	0054461699
	RT4MS TIP	Chisel shape, straight	1.5 mm .059"	0.4 mm .0157"	0054461899
	RT5MS TIP	Chisel shape, bent, 30°	0.8 mm .032"	0.4 mm .0157"	0054461999
	RT6MS TIP	Round shape, beveled, 45°	Ø 1.2 mm .047"	-	0054462099
	RT7MS TIP	Knife tip, 45°	2.2 mm .0866"	-	0054462199
	RT8MS TIP	Chisel tip, straight	2.2 mm .087"	0.4 mm .016"	0054462299
	RT9MS TIP	Chisel tip, straight	0.8 mm .032"	0.4 mm .016"	0054462399
	RT10MS TIP	Gull wing for drag soldering	1.2 mm .047"	2.0 mm .079"	0054462499
	RT11MS TIP	Chisel Tip	3.6 mm .142"	0.9 mm .035"	0054461099

Note: MS tips must be used with a MS handle to meet the Mil Spec



## X-ON Electronics

Largest Supplier of Electrical and Electronic Components

*Click to view similar products for [weller](#) manufacturer:*

Other Similar products are found below :

[SAS3210TRB](#) [0052918099](#) [0058736839](#) [5BSA](#) [0051612499](#) [005 32 566 99](#) [0054465399](#) [PTH6](#) [HE35](#) [SP40NKUS](#) [T0051301199](#)  
[T0051388399](#) [T0051388799](#) [T0051516199](#) [T0052920699](#) [T0053421699](#) [T0053427699](#) [T0053434699](#) [T0053638699](#) [T0058732869](#) [PPT2](#)  
[PSI5](#) [HEW60P](#) [LT4X](#) [CT6E7](#) [D550](#) [D650](#) [WPA2](#) [DS209](#) [DS227](#) [RT6](#) [RTW3MS](#) [EPH101](#) [T0051390699](#) [T0051612199](#) [T0051628899](#)  
[T0052704299](#) [T0052920599](#) [T0052922299](#) [T0053422699](#) [T0053429699](#) [T0053657199](#) [T0054480299](#) [T0056104699N](#) [TC208](#) [WTA3](#)  
[WSTA6](#) [WDH60](#) [WPT15](#) [WEL.PT-F8](#)