

SKKT 27, SKKT 27B, SKKH 27



SEMIPACK[®] 1

Thyristor / Diode Modules

SKKT 27

SKKT 27B

SKKH 27

Features

- Heat transfer through aluminium oxide ceramic isolated metal baseplate
- Hard soldered joints for high reliability
- UL recognized, file no. E 63 532

Typical Applications*

- DC motor control (e. g. for machine tools)
- AC motor soft starters
- Temperature control (e. g. for ovens, chemical processes)
- Professional light dimming (studios, theaters)

1) See the assembly instructions

V_{RSM} V	V_{RRM}, V_{DRM} V	$I_{TRMS} = 50$ A (maximum value for continuous operation) $I_{TAV} = 27$ A (sin. 180; $T_c = 82$ °C)		
900	800	SKKT 27/08E	SKKT 27B08E	SKKH 27/08E
1300	1200	SKKT 27/12E	SKKT 27B12E	SKKH 27/12E
1500	1400	SKKT 27/14E	SKKT 27B14E	SKKH 27/14E
1700	1600	SKKT 27/16E	SKKT 27B16E	SKKH 27/16E
1900	1800			SKKH 27/18E

Symbol	Conditions	Values	Units
I_{TAV}	sin. 180; $T_c = 85$ (100) °C;	25 (18)	A
I_D	P3/180; $T_a = 45$ °C; B2 / B6	38 / 50	A
	P3/180F; $T_a = 35$ °C; B2 / B6	60 / 77	A
I_{RMS}	P3/180; $T_a = 45$ °C; W1 / W3	52 / 3 x 37	A
I_{TSM}	$T_{vj} = 25$ °C; 10 ms	550	A
	$T_{vj} = 125$ °C; 10 ms	480	A
i^2t	$T_{vj} = 25$ °C; 8,3 ... 10 ms	1500	A ² s
	$T_{vj} = 125$ °C; 8,3 ... 10 ms	1150	A ² s
V_T	$T_{vj} = 25$ °C; $I_T = 75$ A	max. 1,8	V
$V_{T(TO)}$	$T_{vj} = 125$ °C	max. 0,9	V
r_T	$T_{vj} = 125$ °C	max. 12	mΩ
$I_{DD}; I_{RD}$	$T_{vj} = 125$ °C; $V_{RD} = V_{RRM}; V_{DD} = V_{DRM}$	max. 10	mA
t_{gd}	$T_{vj} = 25$ °C; $I_G = 1$ A; $di_G/dt = 1$ A/μs	1	μs
t_{gr}	$V_D = 0,67 * V_{DRM}$	1	μs
$(di/dt)_{cr}$	$T_{vj} = 125$ °C	max. 150	A/μs
$(dv/dt)_{cr}$	$T_{vj} = 125$ °C	max. 1000	V/μs
t_q	$T_{vj} = 125$ °C	80	μs
I_H	$T_{vj} = 25$ °C; typ. / max.	100 / 200	mA
I_L	$T_{vj} = 25$ °C; $R_G = 33$ Ω; typ. / max.	250 / 400	mA
V_{GT}	$T_{vj} = 25$ °C; d.c.	min. 3	V
I_{GT}	$T_{vj} = 25$ °C; d.c.	min. 150	mA
V_{GD}	$T_{vj} = 125$ °C; d.c.	max. 0,25	V
I_{GD}	$T_{vj} = 125$ °C; d.c.	max. 5	mA
$R_{th(j-c)}$	cont.; per thyristor / per module	0,9 / 0,45	K/W
	sin. 180; per thyristor / per module	0,95 / 0,48	K/W
	rec. 120; per thyristor / per module	1 / 0,5	K/W
$R_{th(c-s)}$	per thyristor / per module	0,2 / 0,1	K/W
T_{vj}		- 40 ... + 125	°C
T_{stg}		- 40 ... + 125	°C
V_{isol}	a. c. 50 Hz; r.m.s.; 1 s / 1 min.	3600 / 3000	V~
M_s	to heatsink	5 ± 15 % ¹⁾	Nm
M_t	to terminals	3 ± 15 %	Nm
a		5 * 9,81	m/s ²
m	approx.	95	g
Case	SKKT	A 46	
	SKKT ...B	A 48	
	SKKH	A 47	



SKKT

SKKH

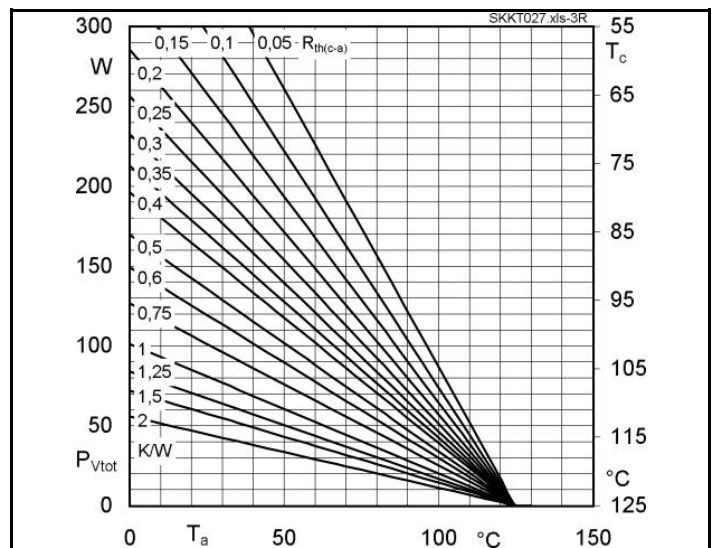
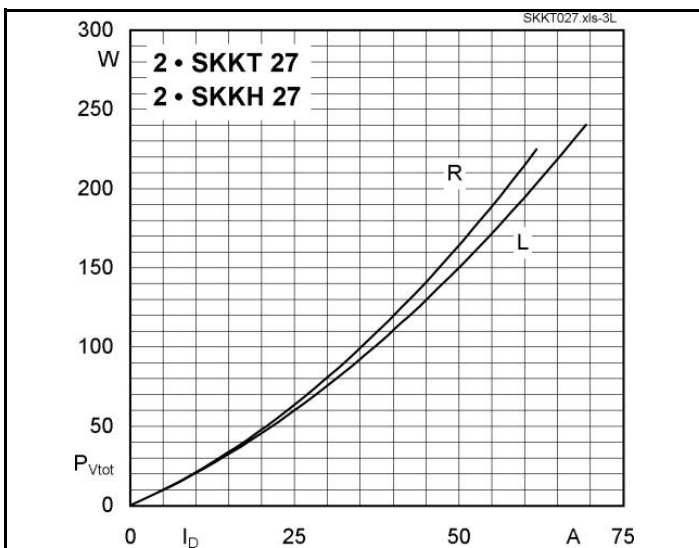
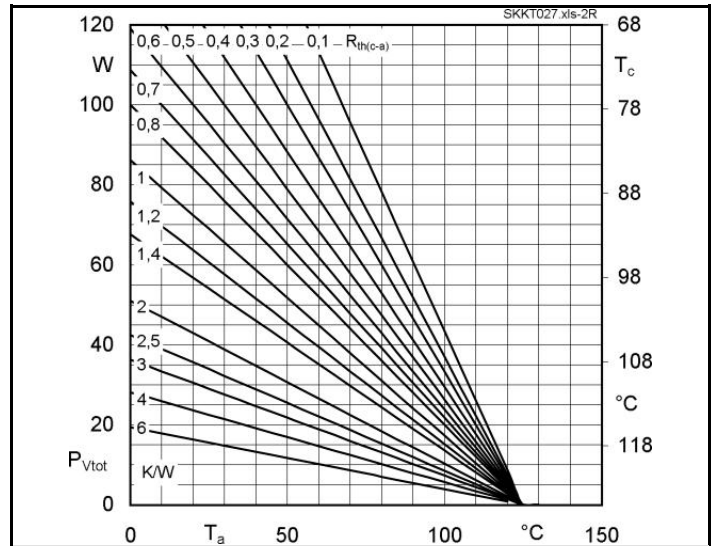
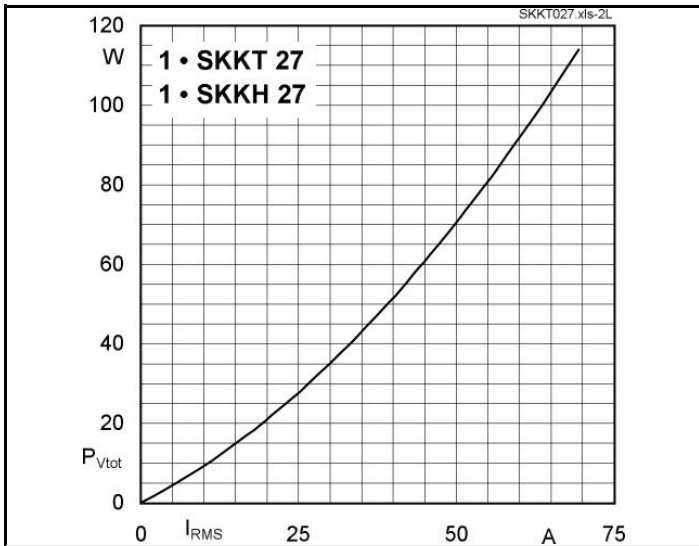
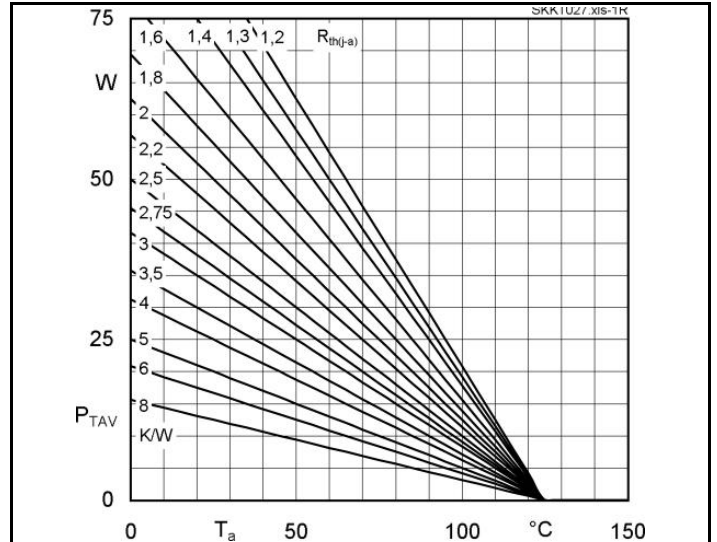
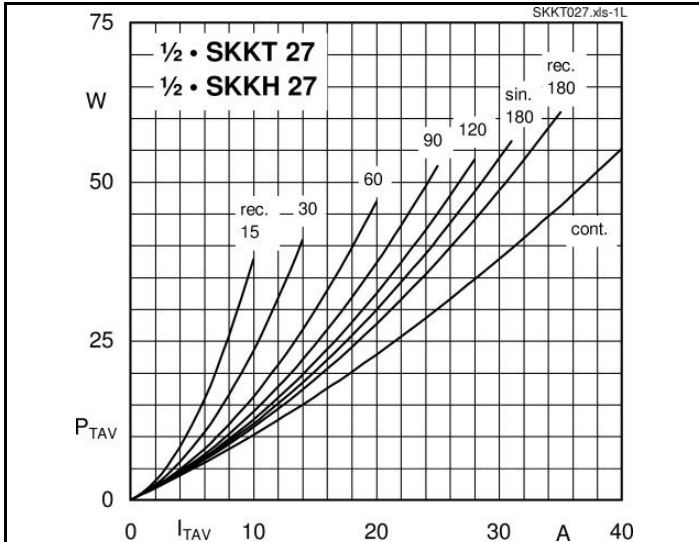

SKKT 27, SKKT 27B, SKKH 27

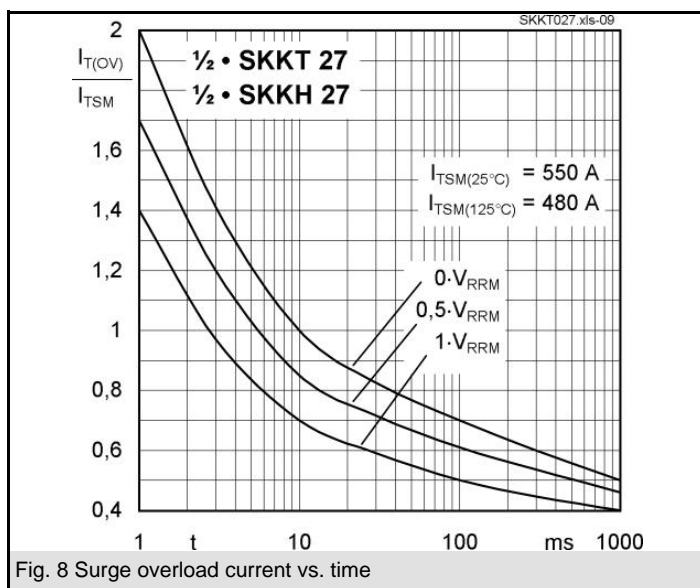
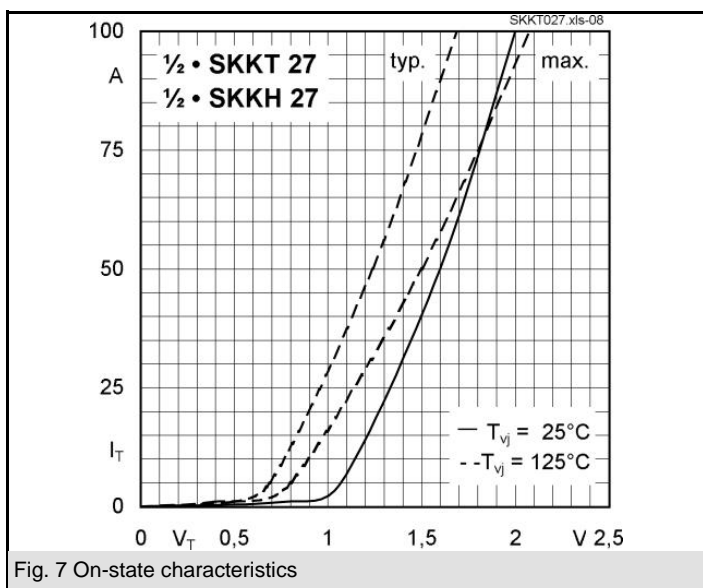
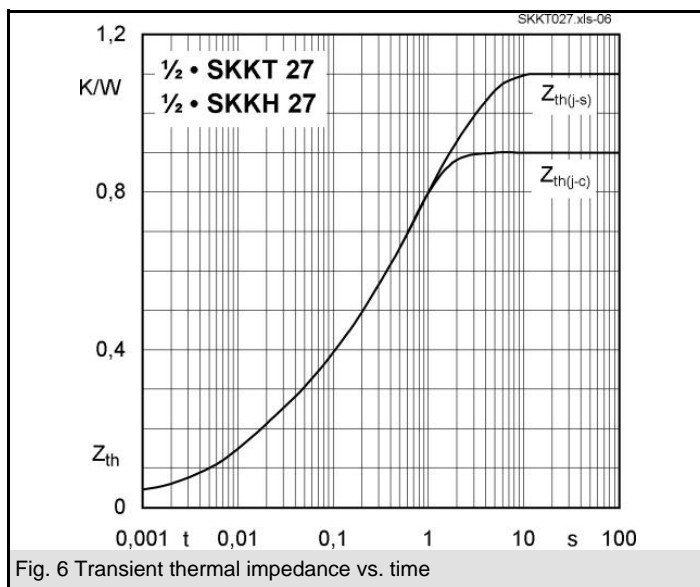
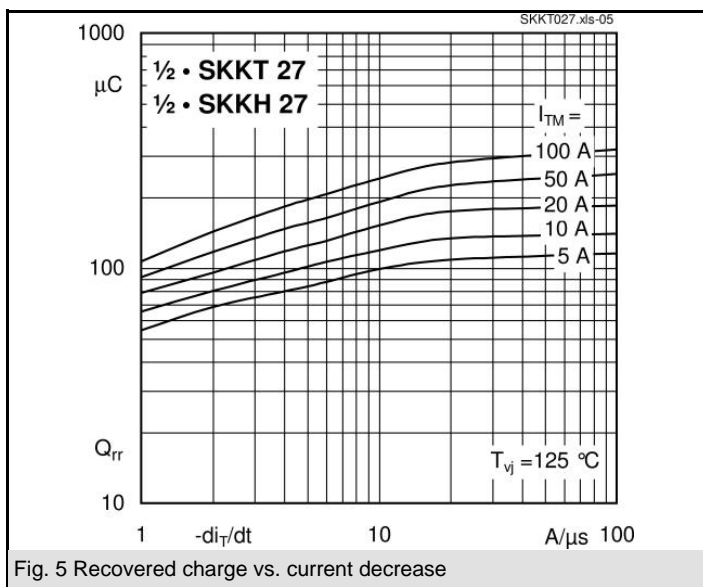
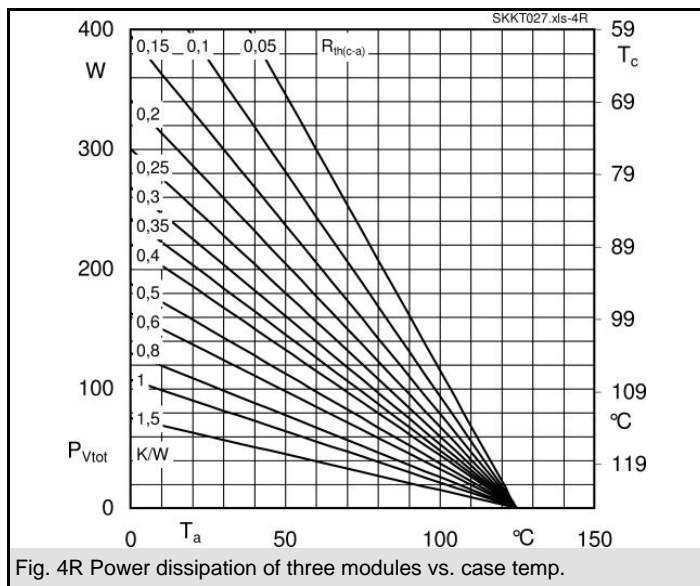
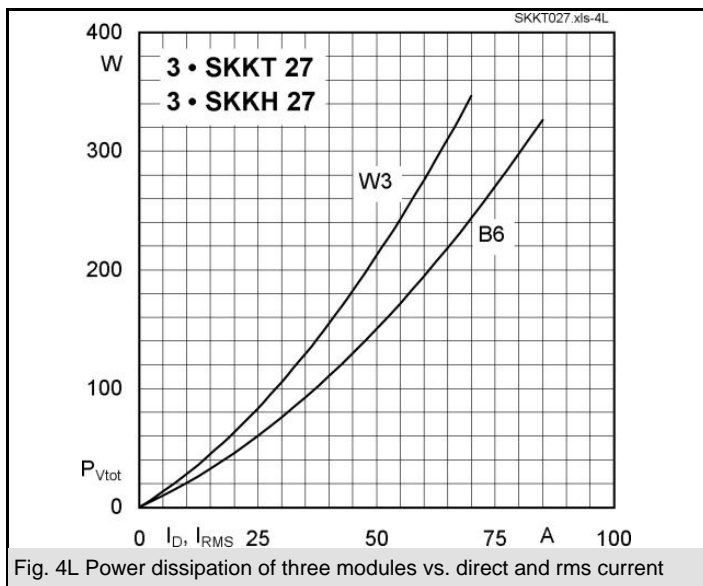

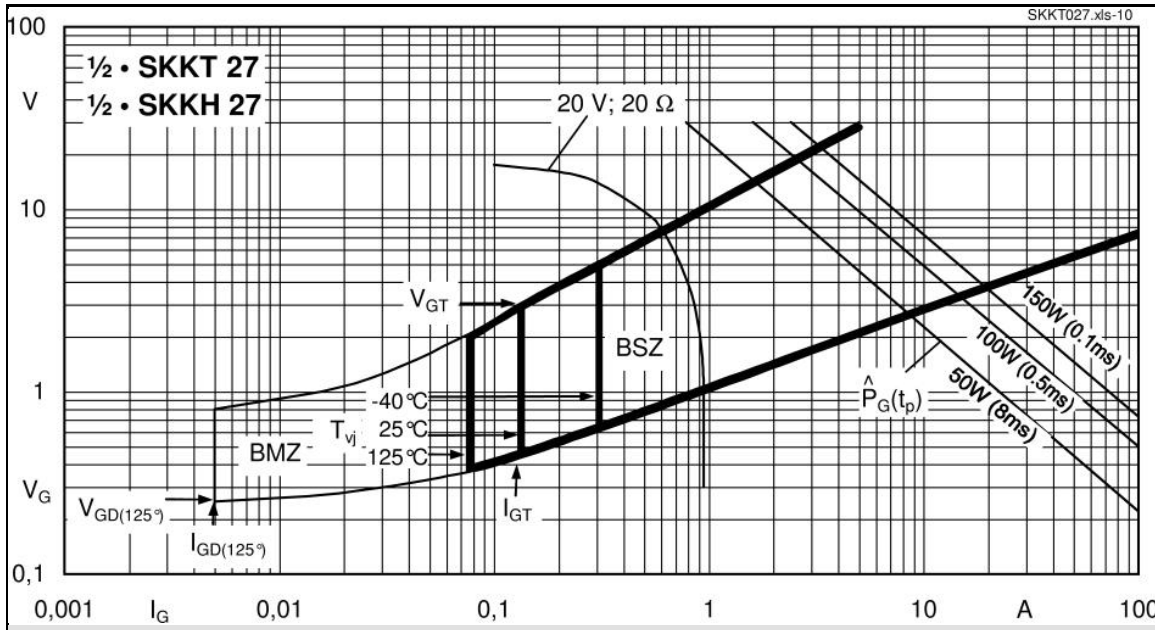
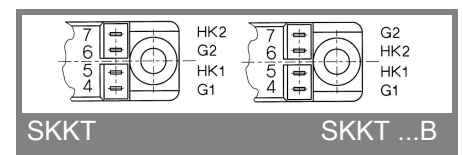
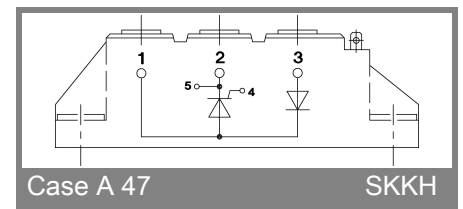
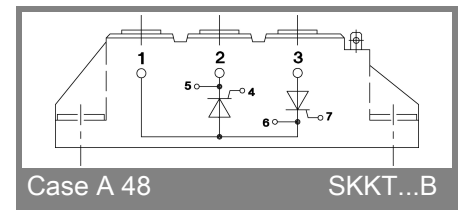
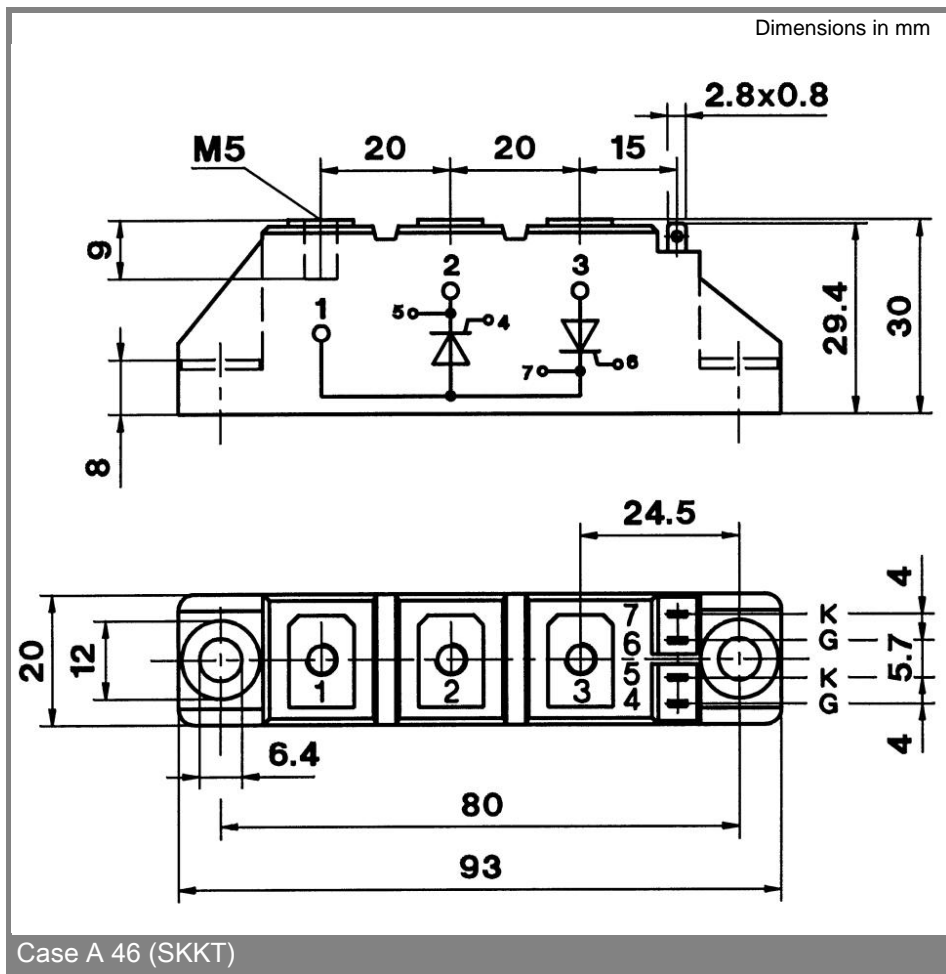

Fig. 9 Gate trigger characteristics



* The specifications of our components may not be considered as an assurance of component characteristics. Components have to be tested for the respective application. Adjustments may be necessary. The use of SEMIKRON products in life support appliances and systems is subject to prior specification and written approval by SEMIKRON. We therefore strongly recommend prior consultation of our personal.

X-ON Electronics

Largest Supplier of Electrical and Electronic Components

Click to view similar products for [SCR Modules](#) category:

Click to view products by [Semikron](#) manufacturer:

Other Similar products are found below :

[DT430N22KOF](#) [DT61N16KOF-K](#) [T1401N42TOH](#) [T1851N60TOH](#) [T390N14TOF](#) [T420N12TOF](#) [T470N16TOF](#) [T640N16TOF](#)
[T901N36TOF](#) [TD142N16KOF](#) [TD162N16KOF-A](#) [TD330N16AOF](#) [TZ310N20KOF](#) [TZ425N12KOF](#) [TZ500N12KOF](#) [T300N14TOF](#)
[T3710N06TOF](#) [VT](#) [T390N16TOF](#) [T420N16TOF](#) [T460N24TOF](#) [T501N70TOH](#) [T560N16TOF](#) [T590N16TOF](#) [T640N14TOF](#) [TD250N14KOF](#)
[TD570N16KOF](#) [TT600N16KOF](#) [TZ240N36KOF](#) [TT210N12KOF](#) [NTE5710](#) [TD180N16KOF](#) [TT240N28KOF](#) [TZ425N14KOF](#)
[T1081N60TOH](#) [TT61N08KOF](#) [TD251N18KOF](#) [TZ240N34KOF](#) [TT162N08KOF](#) [TD285N16KOF](#) [TT180N12KOF](#) [T2001N34TOF](#)
[TT122N22KOF](#) [TD140N22KOF](#) [MDMA200P1600SA](#) [TT180N16KOF](#) [VS-ST180C14C0L](#) [T1080N02TOF](#) [TD320N16SOF](#) [T360N22TOF](#)
[TZ810N22KOF](#)