



Stud Diode

Rectifier Diode

SKN 71

SKR 71

Features

- Reverse voltages up to 1600 V
- Hermetic metal case with glass insulator
- Threaded stud ISO M8 and also 1/4-28 UNF
- SKN: anode to stud, SKR: cathode to stud

Typical Applications

- All-purpose mean power rectifier diodes
- Cooling via heatsinks
- Non-controllable and half-controllable rectifiers
- Free-wheeling diodes
- Recommended snubber network:
RC: 0,1 μ F, 100 Ω ($P_R = 2$ W),
 $R_P = 80$ k Ω ($P_R = 6$ W)

V_{RSM} V	V_{RRM} V	$I_{FRMS} = 150$ A (maximum value for continuous operation) $I_{FAV} = 70$ A (sin. 180; $T_c = 125$ °C)	
400	400	SKN 71/04	SKR 71/04
800	800	SKN 71/08	SKR 71/08
1200	1200	SKN 71/12	SKR 71/12
1400	1400	SKN 71/14	SKR 71/14
1600	1600	SKN 71/16	SKR 71/16

Symbol	Conditions	Values	Units
I_{FAV}	sin. 180; $T_c = 100$ °C	95	A
I_D	K 1,1; $T_a = 45$ °C; B2 / B6	112 / 159	A
	K 1,1F; $T_a = 35$ °C; B2 / B6	174 / 246	A
I_{FSM}	$T_{vj} = 25$ °C; 10 ms	1150	A
	$T_{vj} = 180$ °C; 10 ms	1000	A
i^2t	$T_{vj} = 25$ °C; 8,3 ... 10 ms	6600	A ² s
	$T_{vj} = 180$ °C; 8,3 ... 10 ms	5000	A ² s
V_F	$T_{vj} = 25$ °C; $I_F = 200$ A	max. 1,5	V
$V_{(TO)}$	$T_{vj} = 180$ °C	max. 0,85	V
r_T	$T_{vj} = 180$ °C	max. 3	m Ω
I_{RD}	$T_{vj} = 180$ °C; $V_{RD} = V_{RRM}$	max. 10	mA
Q_{rr}	$T_{vj} = 160$ °C; $-di_F/dt = 10$ A/ μ s	70	μ C
$R_{th(j-c)}$		0,55	K/W
$R_{th(c-s)}$		0,2	K/W
T_{vj}		- 40 ... + 180	°C
T_{stg}		- 55 ... + 180	°C
V_{isol}		-	V~
M_s	to heatsink	4	Nm
a		5 * 9,81	m/s ²
m	approx.	30	g
Case		E 11	



SKN

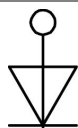

SKR

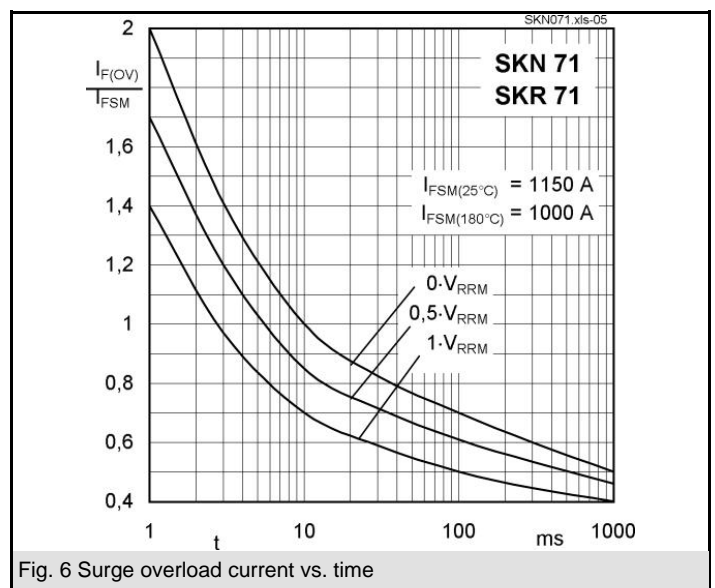
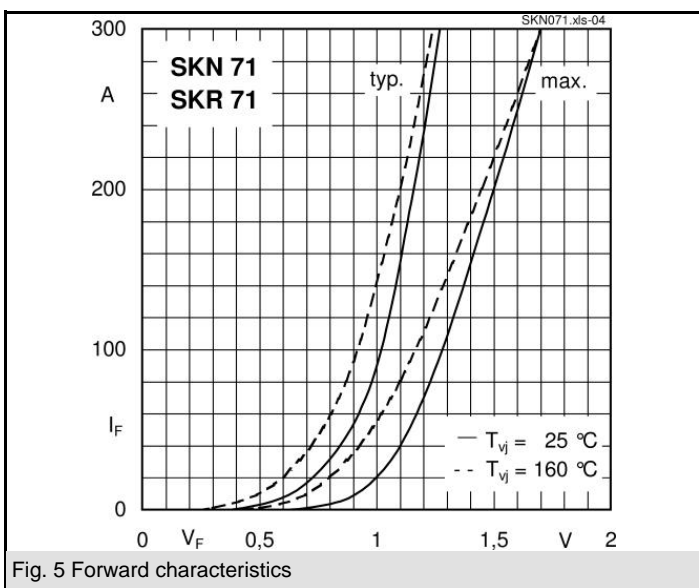
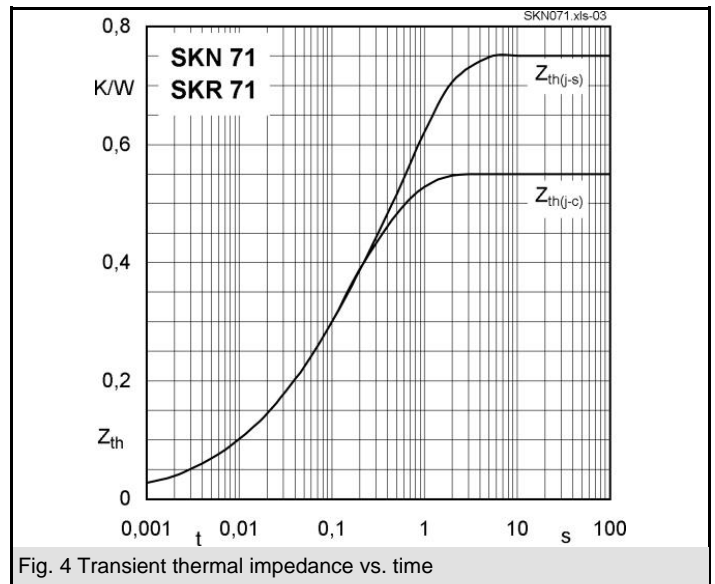
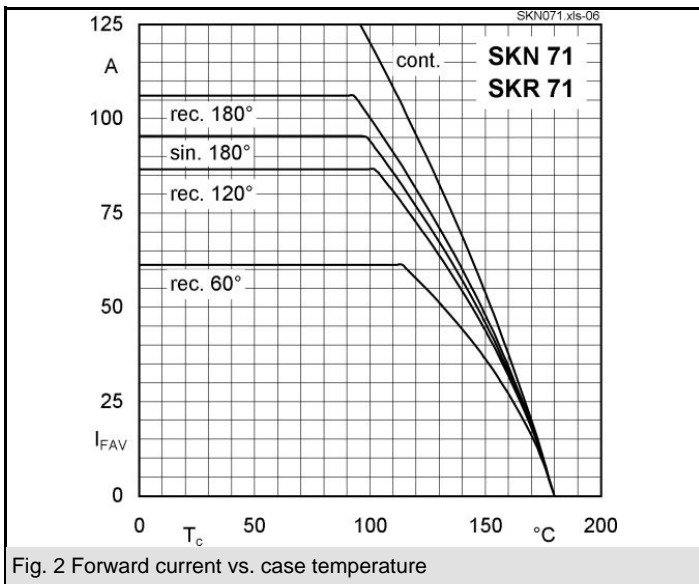
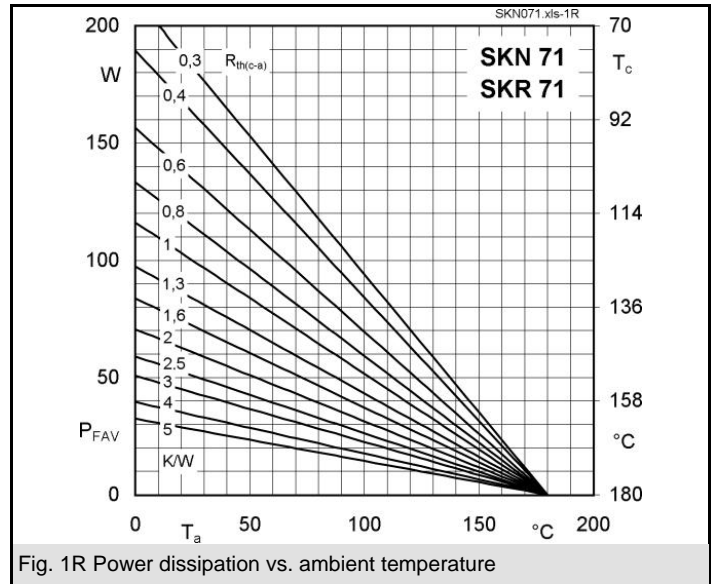
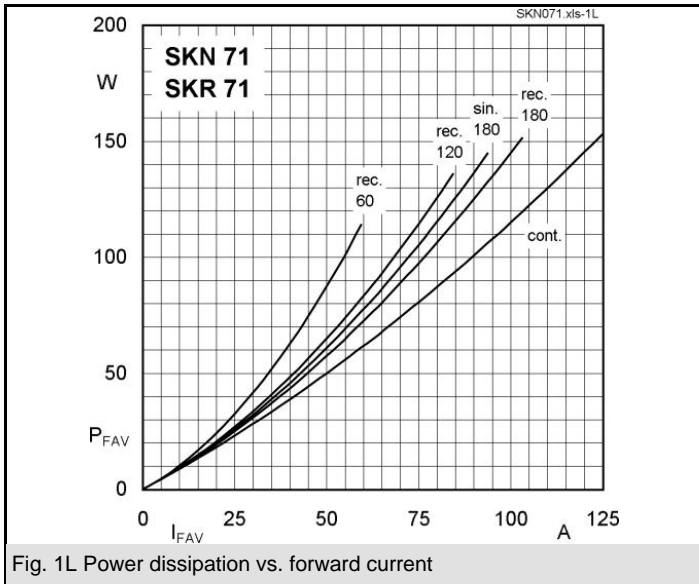

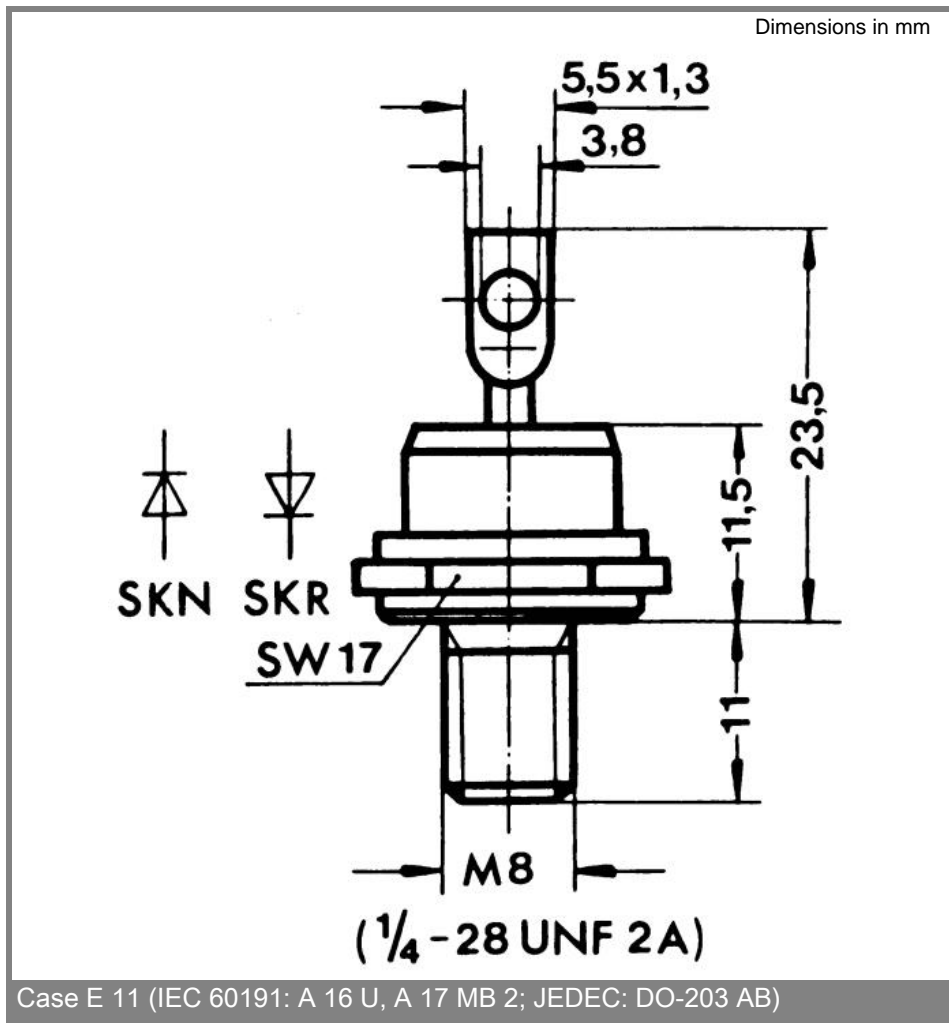

This technical information specifies semiconductor devices but promises no characteristics. No warranty or guarantee expressed or implied is made regarding delivery, performance or suitability.

X-ON Electronics

Authorized Distributor

Click to view similar products for [Rectifiers](#) category.

Click to view products by [Semikron](#) manufacturer.

Other Similar products are found below :

[FR207G](#) [ES1GL](#) [LL4004G](#) [JANTXV1N53051](#) [JAN1N3828A1](#) [SKN10008](#) [6A10](#) [S1ML](#)
[SF3004PT](#) [S5KC13](#) [D7145024N0](#) [D6225016R0](#) [D6225012R0](#) [D6225010N0](#)
[D6225006R0](#) [D5210014N0](#) [D5210012R0](#) [D5210010N0DAA](#) [D5210006N0](#) [D5210004R0](#)
[D5110006R0](#) [D427002N0](#) [D423210N0](#) [D423204N0](#) [D222010N0](#)