

S300

The **S300** series of advanced **MAXI** photoelectric sensors represents the most suitable solution for critical applications thanks to excellent performances and resistance in harsh working conditions. The new series offers a wide range of models and functions in order to guarantee easy use and installation. The new series presents **4** different models with **through beam** optical function up to **60m**, **polarized retroreflex** at **22m**, **diffused proximity** at **5m** and **background suppression** at **2.5m**. All the models are available both **Vdc** from **10 to 30V** and **Vac/Vdc** free-voltage from **24 to 240V** versions. A timing function version and with both the **SPDT** relay or the bipolar transistor **NPN/PNP** open collector outputs is offered. The **terminal block connection** simplifies and speeds-up the installation procedure, whereas the **heavy-duty plastic housing** guarantees excellent resistance under harsh use conditions.



HIGHLIGHTS

- Excellent optical performances
- Sturdy plastic housing with **IP67** mechanical protection
- Defogging system function
- Wide range of operating temperatures ranging from **-40 to 55°C**
- Double independent timing with double time scale from 0-2s and from **0-10s**, **ON-delay**, **OFF delay** **ONE SHOT** timing functions
- **M12 4-pole** rotatable connector for Vdc version and terminal block for Vac/Vdc free-voltage version
- Distance trimmer clutch for mechanical background suppression models

APPLICATIONS

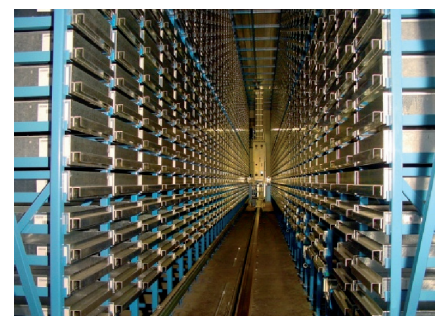

DIMENSIONS

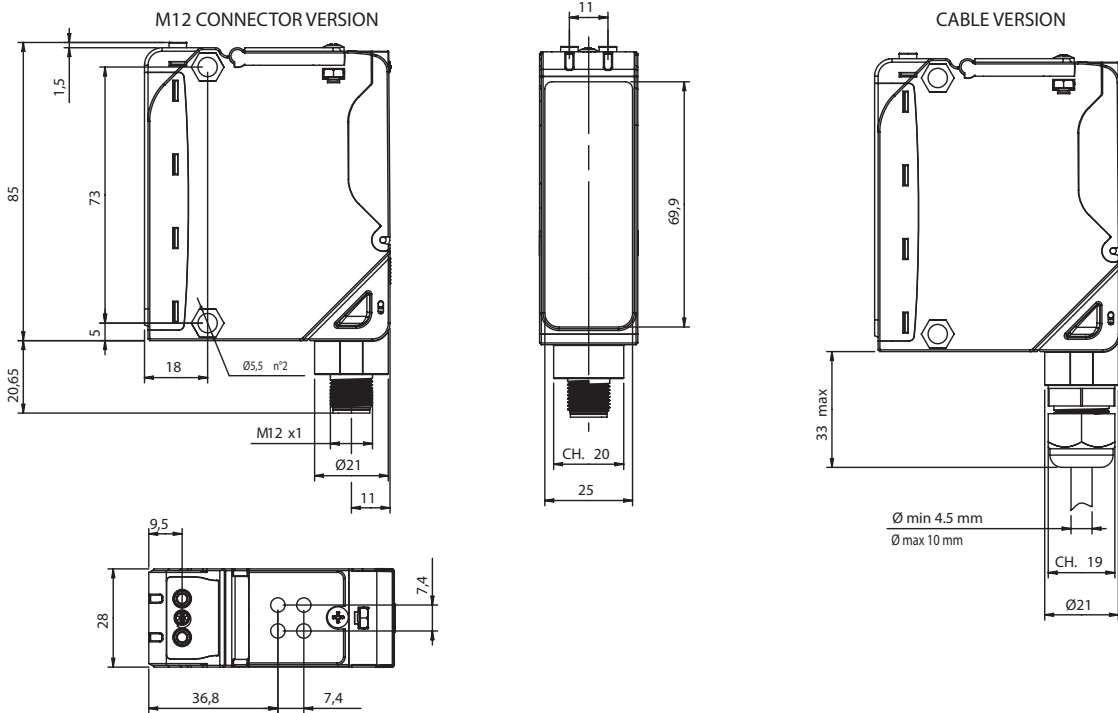

SETTINGS

The **M** model presents a **multiturn adjustment screw** for the adjustment of the background suppression distance using a mechanical variation of the optic triangulation angle. The **other models have a mono-turn electronic trimmer** that adjusts the sensitivity and the sensor operating distance. The operating distance can be increased by rotating the screws clockwise. Trimmers can be used to adjust the **output activation and deactivation delay time** as well as to select the functioning mode.

INDICATORS

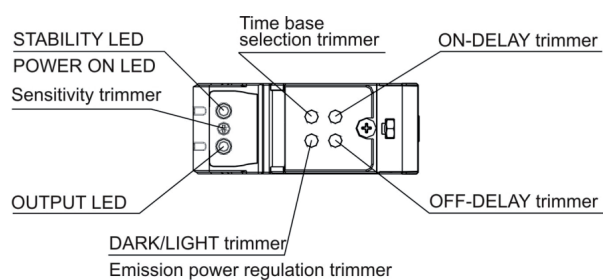

CONNECTIONS G

AC MODELS

DC MODELS

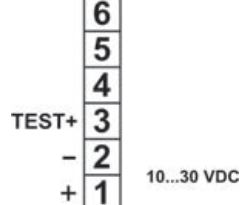
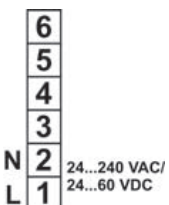

M12 CONNECTOR (only DC models)

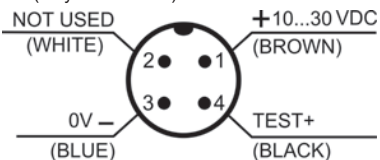

CONNECTIONS B, C, M, F

AC MODELS

ONLY F MODELS

DC MODELS

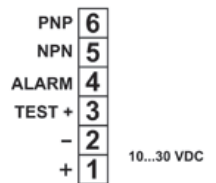
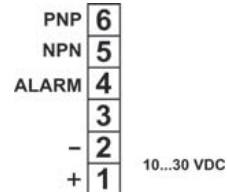
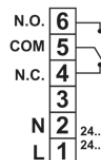

M12 CONNECTOR (only DC models)

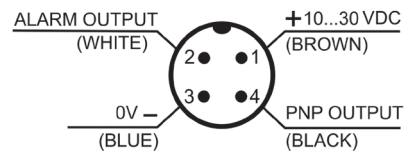

TECHNICAL DATA

COMMON DATA	S300-B	S300-C	S300-M	S300-F	S300-G
Emission type:	Red LED	IR LED	IR LED		IR LED
Operating distances (typical values):	22m	5m	2.5m	60m	
Setting:	Mono-turn sensitivity trimmers		Multi-turn adjustment screw	Mono-turn sensitivity trimmers	
White/Black difference (90% / 4%)	< 15%				
Indicators:	OUTPUT LED (yellow) STABILITY LED (green)			OUTPUT LED (yellow) STABILITY LED (green)	POWER ON LED (green)
Operating temperature:	-40...55°C				
Storage temperature:	-40...70°C				
Dielectric strength:	1500Vac 1 min between electronics and housing				
Insulating resistance:	>20MΩ 500Vdc between electronics and housing				
Ambient light rejection:	according to EN 60947-5-2				
Vibrations:	0.5mm width, 10 ... 55Hz, for each axis (EN60068-2-6)				
Shock resistance:	11ms (30G) 6 shocks for each axis (EN60068-2-27)				
Housing material:	PBT (30% fibre-reinforced glass)				
Lens material:	PC				
Mechanical protection:	IP67 (IEC / EN60529) / NEMA TYPE 1 (For UL / c-UL)				
Connections:	Terminal block (recommended cable diameter: between 8 and 10mm)				

AC VOLTAGE MODELS	S300-B	S300-C	S300-M	S300-F/G
Power supply:	24...240Vac / 12...240Vdc			
Ripple:	10% max			
Consumption (output current excluded):	< 3VA			
Outputs:	SPDT electromagnetic relay: 250Vac, 30Vdc			
Output current:	3A (resistive load)			
Response time:	20ms max			
Switching frequency:	25Hz			
Weight:	150g			

DC MODELS	S300-B	S300-C	S300-M	S300-F/G
Power supply:	12...240Vdc			
Ripple:	10% max			
Consumption (output current excluded):	< 30mA			F= < 25mA G= < 20mA
Outputs:	PNP and NPN open collector			
Output current:	100mA (resistive load)			
Output saturation voltage:	2.4V max			
Response time:	1ms max		2ms max	1ms max
Switching frequency:	500Hz		250Hz	500Hz
Weight:	140gr			



TIMING FUNCTION DIAGRAM

Four selectable **timing functions**: one shot, ON delay, OFF delay and normal mode. **Trimmer adjustment** of the functions is available. The timing functions can be particularly useful in applications where the output signal pulse has to be modified.

OPERATION MODE	OUTPUTS
Normal (timing disable)	
ONE SHOT (only with short time base 0...2 sec.)	
ON/OFF Delay	
ON Delay	
OFF Delay	

DETECTION DIAGRAMS

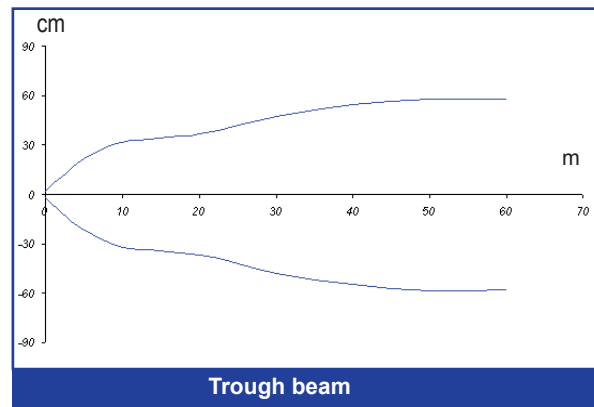
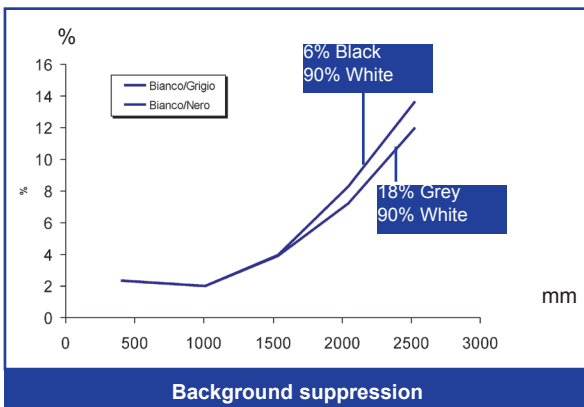
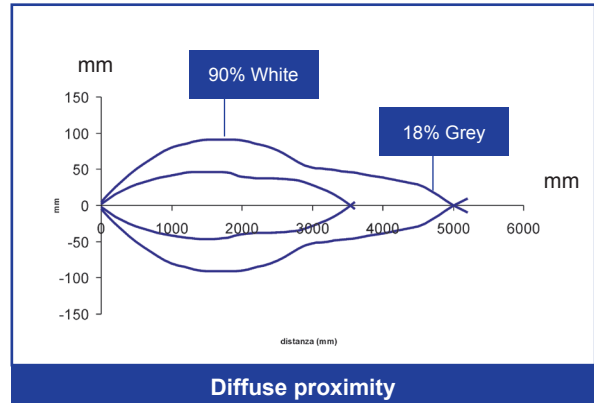
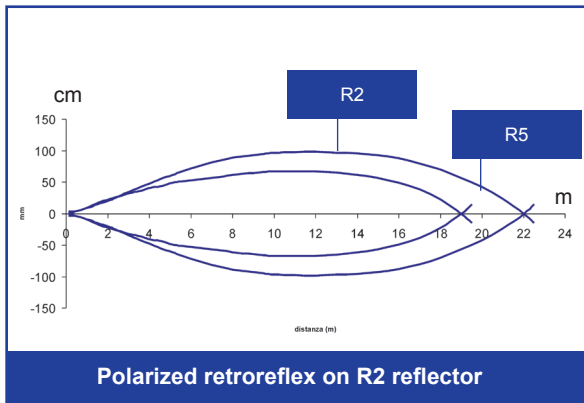

MODEL SELECTION AND ORDER INFORMATION



<u>Power Supply</u>	<u>Optics Function</u>	<u>Timing Function</u>	<u>Output</u>	<u>Version</u>
1 = AC/DC terminal block 2 = DC terminal block 5 = DC M12 4p connector	M = Background Suppression C = Diffused proximity B = Polarized retroreflex F = Receiver G = Emitter	00 = no ADJ, no timing 01 = Adj, no timing 06 = Adj, timing	OC = PNP/NPN RX = Relay NO-NC EX = No outputs	M = Defogging system

ORDER NO.	MODEL	DESCRIPTION
951451140	S300-PR-2-M01-OC	Background suppression, terminal block, DC
951451150	S300-PR-2-M06-OC	Background suppression, terminal block, DC, with timing function
951451160	S300-PR-5-M01-OC	Background suppression, M12 connector, DC
951451170	S300-PR-5-M06-OC	Background suppression, M12 connector, DC, with timing function
951451180	S300-PR-1-M01-RX	Background suppression, terminal block, AC
951451190	S300-PR-1-M06-RX	Background suppression, terminal block, AC, with timing function
951451200	S300-PR-1-M06-RX-M	Background suppression, terminal block, AC, with timing and defogging functions
951451000	S300-PR-2-B01-OC	Polarized retroreflex, terminal block, DC
951451010	S300-PR-2-B06-OC	Polarized retroreflex, terminal block, DC, with timing function
951451020	S300-PR-5-B01-OC	Polarized retroreflex, M12 connector, DC
951451030	S300-PR-5-B06-OC	Polarized retroreflex, M12 connector, DC, with timing function
951451040	S300-PR-1-B01-RX	Polarized retroreflex, terminal block, AC
951451050	S300-PR-1-B06-RX	Polarized retroreflex, terminal block, AC, with timing function
951451060	S300-PR-1-B06-RX-M	Polarized retroreflex, terminal block, AC, with timing and defogging functions
951451070	S300-PR-2-C01-OC	Proximity, terminal block, DC
951451080	S300-PR-2-C06-OC	Proximity, terminal block, DC, with timing function
951451090	S300-PR-5-C01-OC	Proximity, M12 connector, DC
951451100	S300-PR-5-C06-OC	Proximity, M12 connector, DC, with timing function
951451110	S300-PR-1-C01-RX	Proximity, terminal block, AC
951451120	S300-PR-1-C06-RX	Proximity, terminal block, AC, with timing function
951451130	S300-PR-1-C06-RX-M	Proximity, terminal block, AC, with timing and defogging functions
951451210	S300-PR-2-F01-OC	Receiver, terminal block, DC
951451220	S300-PR-2-F06-OC	Receiver, terminal block, DC, with timing function
951451230	S300-PR-5-F01-OC	Receiver, M12 connector, DC
951451240	S300-PR-5-F06-OC	Receiver, M12 connector, DC, with timing function
951451250	S300-PR-1-F01-RX	Receiver, terminal block, AC
951451260	S300-PR-1-F06-RX	Receiver, terminal block, AC, with timing function
951451270	S300-PR-1-F06-RX-M	Receiver, terminal block, AC, with timing and defogging functions
951451280	S300-PR-2-G00-EX	Emitter, terminal block, DC
951451290	S300-PR-5-G00-EX	Emitter, M12 connector, DC
951451300	S300-PR-1-G00-EX	Emitter, terminal block, AC
951451310	S300-PR-1-G00-EX-M	Emitter, terminal block, AC, with timing and defogging functions

ACCESSORY SELECTION AND ORDER INFORMATION

MODEL	DESCRIPTION	ORDER N°
ST-5099	FIXED BRACKET	95ACC2830
ST-5100	FIXED BRACKET	95ACC2840
DataVS-MK-01	MOUNTING KIT	95A901380

ACCESSORY DRAWINGS

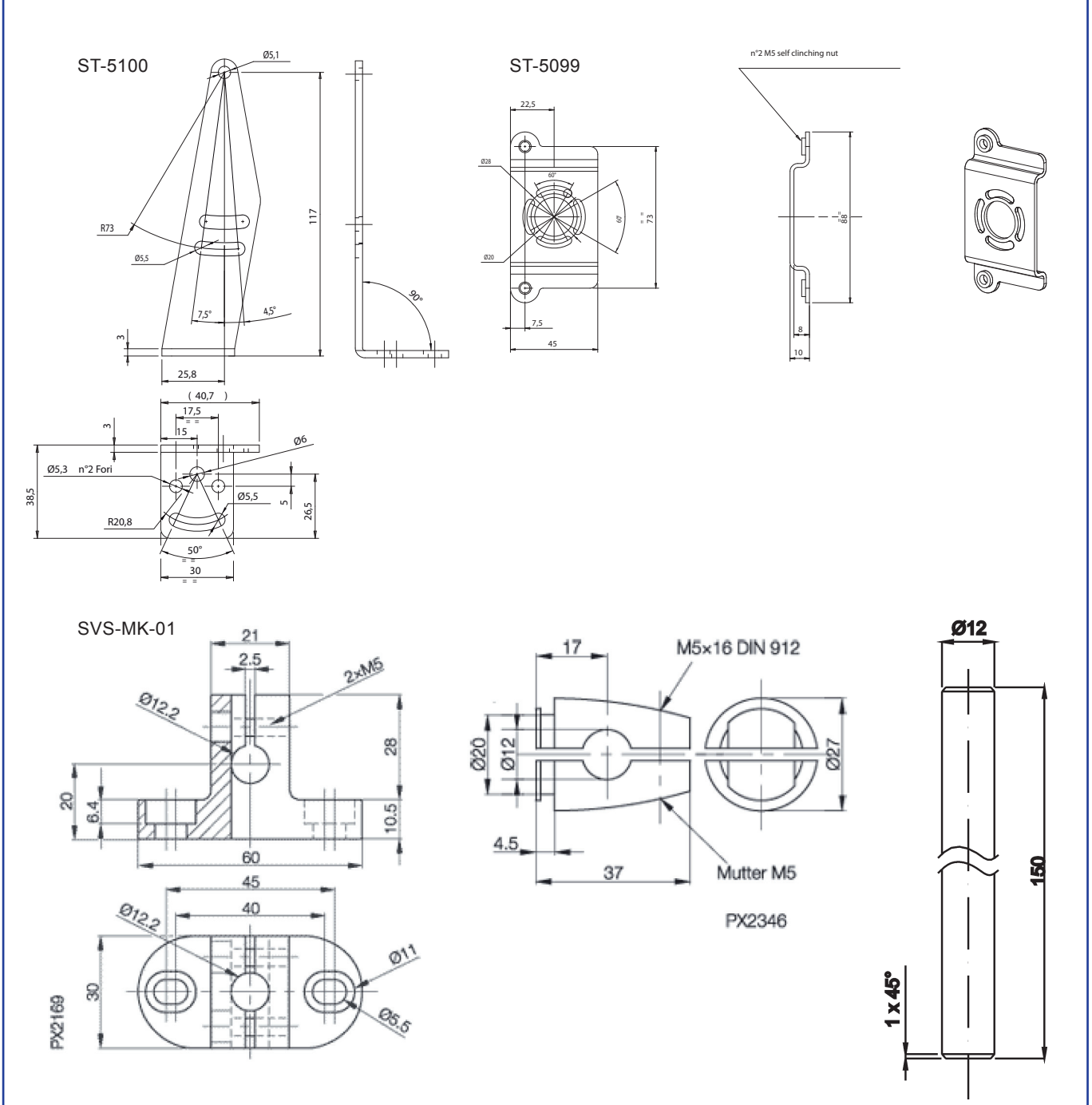

The company endeavours to continuously improve and renew its products; for this reason the technical data and contents of this catalogue may undergo variations without prior notice. For correct installation and use, the company can guarantee only the data indicated in the instruction manual supplied with the products.



X-ON Electronics

Largest Supplier of Electrical and Electronic Components

Click to view similar products for [datalogic](#) manufacturer:

Other Similar products are found below :

[950411050](#) [950411300](#) [950411120](#) [950411240](#)