

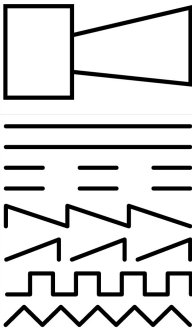

Acoustic device, 24V, multi-tone

Part no. **SL7-AP24-M**
 Article no. **171287**
 Catalog No. **SL7-AP24-M**

Delivery programme

Product range			SL7 signal towers
Basic function			Acoustic module
Degree of Protection			IP66
Rated operational voltage	U_e	V	24 V AC/DC
Rated operational current	I_e	mA	115
Description			Multi-tone; 8 tones, adjustable with internal dip switch. Sound pressure 100 db, adjustable with internal potentiometer. $f = 500 - 2700$ Hz Place only at the highest position on a pole
Colour			
			
Function			
Connection to SmartWire-DT			no

Technical data

General







Standards			IEC/EN 60947-5-1
Climatic proofing			Damp heat, constant, to IEC 60068-2-78 Damp heat, cyclic, to IEC 60069-2-30
Mounting position			As required
Mechanical shock resistance		g	> 15 according to IEC 60068-2-27 Shock duration 11 ms Sinusoidal
IEC degree of protection			IP66 IEC/EN 60529
Protection type UL			Type 4, 4X, 13
Material			Enclosure: Polycarbonate (PC), black Cap: Polycarbonate (PC)
Ambient temperature		°C	-30 - +60
Weight		g	102

Contacts

Rated impulse withstand voltage	U_{imp}	V AC	4000
Rated insulation voltage	U_i	V	250
Overvoltage category/pollution degree			III/3

modules

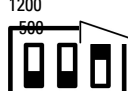
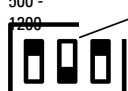
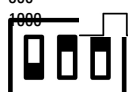
Leakage current		A	< 0.003
Type of tone			Continuous or pulsed tone 8 types of sound
Types of sound			8 versions, table of sound types
Sound setting			Internal; 3 pole DIP
Table of sound types			Table of sound types

			Sound type	DIP switch settings	Frequency Hz	Diagram	Repeat rate	Special application	Max. volume
			SL7-AP...-M	Continuous tone	2700		-	-	dB 100
				Continuous tone	1350		-	-	100
				Pulsed tone	2700		250 ms on, 250 ms off	-	100
				Pulsed tone	1350		250 ms on, 250 ms off	-	100
				falling	1200		500	1 Hz	Evacuation Germany, DIN3304-3
				Rising	500 - 1200		3 s rising, 0.5 s off	Netherlands NEN 2575:2000	88
				Alternating	800 - 1000		2 Hz		94
				rising/falling	500 - 1500		10 Hz		94
Sound pressure		dB							100
Sound pressure level adjustment									Built-in, potentiometer
Sound_pressure_can_be_lowered_to_a_minimum_of									88 dB
Transmission angle									360°
Current-/power consumption									
24 V AC/DC		A							0.115
Voltage levels									24 V AC/DC ± 10 %

Design verification as per IEC/EN 61439

Technical data for design verification			
Operating ambient temperature min.		°C	-30
Operating ambient temperature max.		°C	60

Technical data ETIM 5.0

Low-voltage industrial components (EG000017) / Acoustic module for signal tower (EC001261)			
Electric engineering, automation, process control engineering / Low-voltage switch technology / Command and alarm device / Signal column element, acoustic (ecl@ss8-27-37-12-37 [AKF055010])			
Function			-
Outer diameter		mm	73
Degree of protection (IP)			IP66
Colour			Black
Operating voltage at AC 50 Hz		V	24 - 24
Operating voltage at AC 60 Hz		V	24 - 24
Operating voltage at DC		V	24 - 24
Voltage type			AC/DC
Tone adjustable			Yes

Approvals

Product Standards		IEC/EN 60947-5-1; UL 508; CSA-C22.2 No. 14-10; CSA-C22.2 No. 94-91; CE marking
UL File No.		E29184
UL Category Control No.		NKCR
CSA File No.		UL report applies to both US and Canada
CSA Class No.		NKCR7
North America Certification		UL listed, certified by UL for use in Canada
Degree of Protection		UL Type 4, 4X, 13

Dimensions

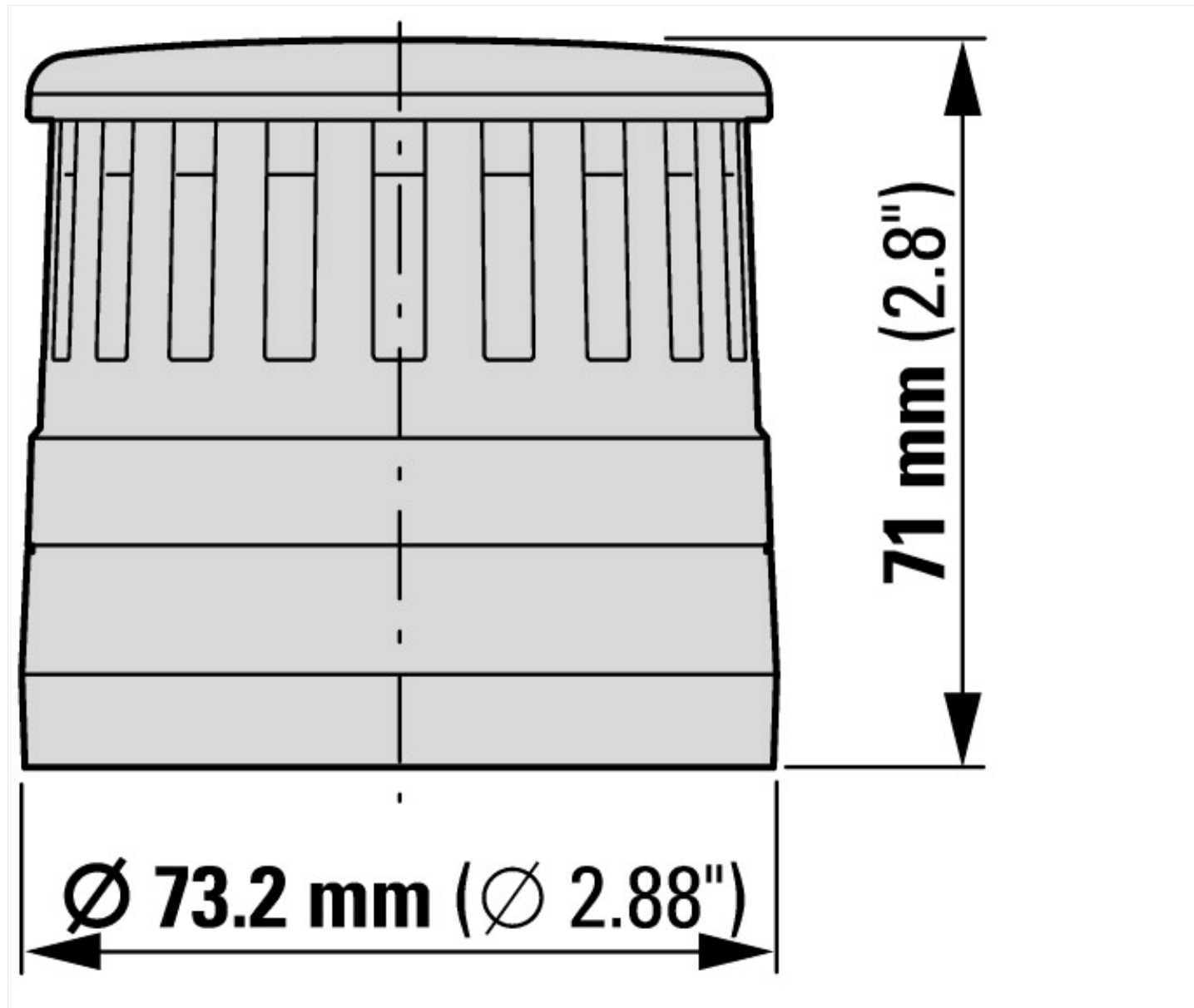

Additional product information (links)

IL047004ZU SL7 Light Modules, Tone Modules

IL047004ZU SL7 Light Modules, Tone Modules ftp://ftp.moeller.net/DOCUMENTATION/AWA_INSTRUCTIONS/IL047004ZU2013_02.pdf

IL047004ZU SL7, modules lumineux, modules sonores ftp://ftp.moeller.net/DOCUMENTATION/AWA_INSTRUCTIONS/IL047004ZU2013_02.pdf

X-ON Electronics

Largest Supplier of Electrical and Electronic Components

Click to view similar products for [LED Lighting Fixtures](#) category:

Click to view products by [Eaton](#) manufacturer:

Other Similar products are found below :

[1301080067](#) [XVEC21P](#) [XVEC2B7](#) [113163000-00662717](#) [113472000-00691461](#) [LD6A-3DQB-RYG](#) [LD6A-3DZQB-RYG](#) [LF1B-NA3P-2THWW2-3M](#) [LF1B-NC3P-2THWW2-3M](#) [LF1B-ND3P-2THWW2-3M](#) [E35600](#) [NB-RLAMP01-LED](#) [FLK7LED](#) [LD6A-3WQB-RYG](#) [XVC4B3K](#) [XVBC4M7](#) [2702482](#) [2702935](#) [ZWF-638-24CW](#) [ZAF-486-24CW](#) [BC5000-N-S](#) [BP3200-C-S-24](#) [BP3200-C-F-12](#) [BP3100-C-S](#) [BC5000-C-S](#) [2403122](#) [2403121](#) [2402991](#) [113261000-00641180](#) [113259000-00641174](#) [190007019-00014904](#) [226108019-00610754](#) [4823](#) [4824](#) [4866](#) [4868](#) [E35611](#) [11212573001-00514271](#) [112887037-00076065](#) [113021000-00564565](#) [113473000-00704968](#) [NB-RLAMP01](#) [E35500](#) [408001403-00671626](#) [LD6A-3WZQB-RYG](#) [LF1B-NA4P-2THWW2-3M](#) [LF1B-NB3P-2THWW2-3M](#) [LF1D-C2F-2W-330](#) [LF1B-ND4P-2THWW2-3M](#) [LF1B-NF3P-2THWW2-3M](#)