



# Compact Sensors

## WORLD-BEAM® QS18 ..... page 66

- Universal photoelectric family offers 18 mm threaded lens or side mounts.
- One sensor family replaces hundreds of other sensor styles.
- One housing design fulfills all mounting requirements.
- All sensing modes are available including laser, fiber optic and ultrasonic.
- Ranges are up to 30 m.
- A wide variety of connecting options are available.
- QS18 *Expert™* visible red diffuse and plastic fiber optic models will be available soon—contact factory or visit [www.bannerengineering.com](http://www.bannerengineering.com) for more information.



## MINI-BEAM® . . . . . page 75

- Extensive family in all sensing modes and ranges to 30 m
- *Expert™* push-button teachable models
- Models for special needs—clear plastic detection, NAMUR outputs
- World's most popular photoelectric



## M18 . . . . . page 92

- Rugged 18 mm stainless steel threaded barrels
- Opposed, polarized, non-polarized retroreflective, diffuse and fixed-field modes
- Dual LED indicators
- Specially designed EZ-BEAM® style optics and electronics for reliable sensing without adjustments



## QH23/Q23 . . . . . page 88

- Choice of vertical or horizontal housing
- High power in a small package
- Ranges to 8 m
- Five sensing modes including polarized retroreflective

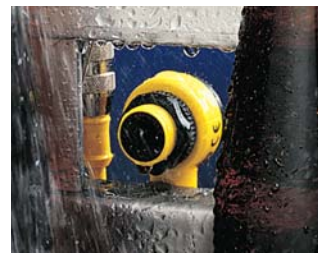

## T18 . . . . . page 98

- Right-angle, T-shaped package
- Specialized fixed-field and polarized retroreflective models
- Specially designed EZ-BEAM® style optics and electronics for reliable sensing without adjustments
- Models for ac or dc power



## S18 . . . . . page 92

- 18 mm threaded plastic barrels
- Specialized laser diode emitter models
- Specially designed EZ-BEAM® style optics and electronics for reliable sensing without adjustments
- Models for ac or dc power



## Q25 . . . . . page 103

- Compact rectangular 25 mm right angle housing with 18 mm threaded mounting base
- Completely epoxy encapsulated
- Specially designed EZ-BEAM® style optics and electronics for reliable sensing without adjustments
- Models for ac or dc power

# WORLD-BEAM®

## QS18 Series Universal Sensors

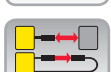
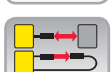
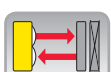
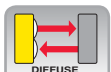
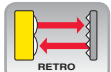
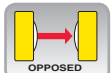
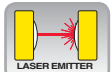

- Features a universal housing with an 18 mm threaded lens or side mounts
- Replaces hundreds of other sensors
- Meets IP67 and NEMA 6 standards for harsh environments
- Available in opposed, polarized and non-polarized retroreflective, convergent, regular and wide-angle diffuse, laser, ultrasonic, plastic or glass fiber optic, fixed-field and adjustable-field sensing modes
- Offers easy push-button TEACH-mode setup in *Expert™* QS18E and ultrasonic models
- Ranges up to 20 m

Bright LED operating status indicators visible from 360°

Optional 18 mm threaded lens mount on some models

Side mount standard on all models

Rugged sealed housing, protected circuitry

Variety of cable and connector options



### QS18

- Eight sensing modes for solving most applications: opposed, retroreflective, convergent, diffuse, plastic and glass fiber optic, and adjustable field and fixed field
- High power, visible red and infrared sensing beam
- Highly visible diagnostics

### QS18 Expert™

- Advanced teachable microprocessor
- Single push-button programming
- Instant learning of difficult sensing condition
- Reliable detection of transparent and reflective objects

### QS18 Laser

- Opposed, diffuse, retroreflective and adjustable-field models
- High-performance sensing with visible Class 1 lasers
- Long sensing ranges
- Ideal for confined areas
- Emitter models available with five beam shapes

### QS18 Background Suppression

- Adjustable-field models with cutoff point from 20 to 100 mm or 30 to 150 mm
- Fixed-field models sensing range of 50 or 100 mm
- Visible red LED or laser sensing beam
- Accurate and reliable even with low-reflectivity targets
- Ideal for small, difficult-to-access areas



QS18 ..... Page 67

QS18 Laser Emitter ..... 68

QS18 Laser models ..... 68

QS18 Background Suppression ..... 69

QS18 Expert™ ..... 72

QS18 Ultrasonic ..... 73



# WORLD-BEAM® QS18 Sensors

- Optional 18 mm threaded lens mount on some models
- A variety of cable and connector options
- Rugged sealed housing, protected circuitry
- Bright LED operating status indicators visible from 360°

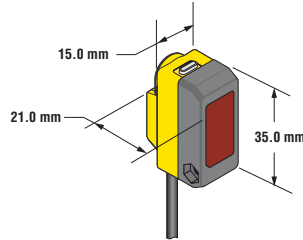

Opposed and Diffuse Models  
Suffix EB, RB, DB and W

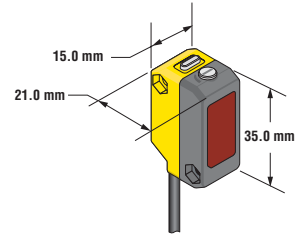

Adjustable-field Models  
Suffix AF100 and LAF

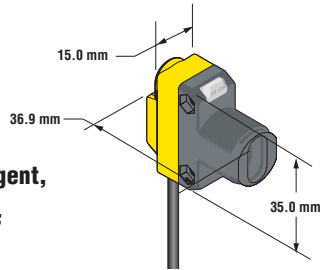

Glass Fiber Models  
Suffix F

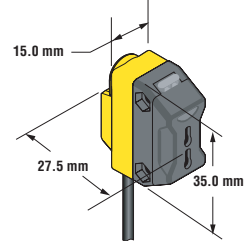

Plastic Fiber Models  
Suffix FP

Opposed, Retroreflective, Laser Retroreflective, Convergent, Diffuse, Laser Diffuse and Fixed-field Models  
Suffix E, R, LV, LP, LLP, CV15, CV45, D, LD, LE and FF



## WORLD-BEAM® QS18, 10-30V dc

Models	Sensing Mode/LED*	Range	Cable**	Output Type	Excess Gain	Beam Pattern	Data Sheet
QS186E Emitter QS186EQ8 Emitter	 OPPOSED	20 m	2 m 4-pin Euro QD	—	EGCO-8 (p. 428)	BPO-8 (p. 450)	63908
QS18VN6R QS18VN6RQ8			2 m 4-pin Euro QD	NPN			
QS18VP6R QS18VP6RQ8			2 m 4-pin Euro QD	PNP			
QS186EB Emitter QS186EBQ8 Emitter		3 m	2 m 4-pin Euro QD	—	EGCO-9 (p. 428)	BPO-9 (p. 450)	
QS18VN6RB QS18VN6RBQ8			2 m 4-pin Euro QD	NPN			
QS18VP6RB QS18VP6RBQ8			2 m 4-pin Euro QD	PNP			

\* Infrared LED

\*\* For 9 m cable, add suffix **W/30** to the 2 m model number (example, **QS186E W/30**). A model with a QD requires a mating cable (see pages 378 and 380).

**QD models:**

- For 4-pin integral Euro-style QD, add suffix **Q8** (example, **QS186EQ8**).
- For 4-pin integral Pico-style QD, add suffix **Q7** (example, **QS186EQ7**).

- For 4-pin 150 mm Euro-style pigtail, add suffix **Q5** (example, **QS186EQ5**).
- For 4-pin 150 mm Pico-style pigtail, add suffix **Q** (example, **QS186EQ**).



**WORLD-BEAM® QS18, 10-30V dc (cont'd)**



Models	Sensing Mode/LED*	Range	Cable**	Output Type	Excess Gain	Beam Pattern	Data Sheet
QS186LE*** QS186LEQ8***	LASER EMITTER	15 m (4500 X excess gain)	2 m 4-pin Euro QD	—	See Data sheet for more information.		109415
QS186LE10 QS186LE10Q8	LASER SPOT 	See Data sheet for more information.	2 m 4-pin Euro QD				
QS186LE11 QS186LE11Q8	LASER SPOT 		2 m 4-pin Euro QD				
QS186LE12 QS186LE12Q8	LASER SPOT 		2 m 4-pin Euro QD				
QS186LE14 QS186LE14Q8	LASER SPOT 		2 m 4-pin Euro QD				
QS18VN6LV QS18VN6LVQ8	RETRO		6.5 m†				
QS18VP6LV QS18VP6LVQ8		2 m 4-pin Euro QD		PNP			
QS18VN6LP QS18VN6LPQ8	POLAR RETRO	3.5 m†	2 m 4-pin Euro QD	NPN	EGCR-8 (p. 431)	BPR-8 (p. 453)	
QS18VP6LP QS18VP6LPQ8			2 m 4-pin Euro QD	PNP			
QS18VN6LLP QS18VN6LLPQ8	LASER POLAR RETRO	10 m††	2 m 4-pin Euro QD	NPN	EGCR-9 (p. 431)	—	118900
QS18VP6LLP QS18VP6LLPQ8			2 m 4-pin Euro QD	PNP			
QS18VN6CV15 QS18VN6CV15Q8	CONVERGENT	16 mm	2 m 4-pin Euro QD	NPN	EGCC-9 (p. 437)	BPC-9 (p. 459)	63908
QS18VP6CV15 QS18VP6CV15Q8			2 m 4-pin Euro QD	PNP			
QS18VN6CV45 QS18VN6CV45Q8		43 mm	2 m 4-pin Euro QD	NPN	EGCC-10 (p. 437)	BPC-10 (p. 459)	
QS18VP6CV45 QS18VP6CV45Q8			2 m 4-pin Euro QD	PNP			

\* Visible Red LED Visible Red Laser

\*\* For 9 m cable, add suffix **W/30** to the 2 m model number (example, **QS18VN6LV W/30**). A model with a QD requires a mating cable (see pages 378 and 380).  
**QD models** (except Laser Emitters):

- For 4-pin integral Euro-style QD, add suffix **Q8** (example, **QS18VN6LVQ8**).
- For 4-pin integral Pico-style QD, add suffix **Q7** (example, **QS18VN6LVQ7**).
- For 4-pin 150 mm Euro-style pigtail, add suffix **Q5** (example, **QS18VN6LVQ5**).
- For 4-pin 150 mm Pico-style pigtail, add suffix **Q** (example, **QS18VN6LVQ**).

\*\*\* Specified with QS18 threaded lens receiver. Not recommended for dusty or dirty environments; the scattered light would greatly reduce excess gain.

† Retroreflective range is specified using one model BRT-84 retroreflector. Actual sensing range may differ, depending on the efficiency and reflective area of the retroreflector used. See Accessories for more information.

†† Retroreflective range is specified using one model BRT-51X51BM or BXT-TVHG-2X2 retroreflector. Actual sensing range may differ, depending on the efficiency and reflective area of the retroreflector used. See Accessories for more information.



# WORLD-BEAM® QS18, 10-30V dc (cont'd)

Models	Sensing Mode/LED*	Range	Cable**	Output Type	Excess Gain	Beam Pattern	Data Sheet
QS18VN6D QS18VN6DQ8	DIFFUSE	450 mm	2 m 4-pin Euro QD	NPN	EGCD-6 (p. 434)	BPD-6 (p. 456)	63908
QS18VP6D QS18VP6DQ8			2 m 4-pin Euro QD	PNP			
QS18VN6DB QS18VN6DBQ8			2 m 4-pin Euro QD	NPN	EGCD-7 (p. 434)	BPD-7 (p. 456)	
QS18VP6DB QS18VP6DBQ8			2 m 4-pin Euro QD	PNP			
QS18VN6W QS18VN6WQ8	DIVERGENT DIFFUSE	100 mm	2 m 4-pin Euro QD	NPN	EGCD-8 (p. 434)	BPD-8 (p. 456)	63908
QS18VP6W QS18VP6WQ8			2 m 4-pin Euro QD	PNP			
QS18VN6LD QS18VN6LDQ8	LASER DIFFUSE	300 mm	2 m 4-pin Euro QD	NPN	EGCD-9 (p. 434)	BPD-42 (p. 458)	118899
QS18VP6LD QS18VP6LDQ8			2 m 4-pin Euro QD	PNP			
QS18VN6AF100 QS18VN6AF100Q5	ADJUSTABLE-FIELD	1 mm to cutoff point (adj. between 20-100 mm)	2 m 4-pin Euro Pigtail QD	NPN	EGCA-1 (p. 440)	—	66981
QS18VP6AF100 QS18VP6AF100Q5			2 m 4-pin Euro Pigtail QD	PNP	Cutoff Point Deviation Curve CPDC-1 (p. 474)		
QS18VN6LAF QS18VN6LAFQ5	LASER ADJUSTABLE-FIELD	1 mm to cutoff point (adj. between 30-150 mm)	2 m 4-pin Euro Pigtail QD	NPN	EGCA-2 (p. 440)	—	
QS18VP6LAF QS18VP6LAFQ5			2 m 4-pin Euro Pigtail QD	PNP	Cutoff Point Deviation Curve CPDC-2 (p. 474)		
QS18VN6FF50 QS18VN6FF50Q8	FIXED-FIELD	0-50 mm Cutoff	2 m 4-pin Euro QD	NPN	EGCF-4 (p. 441)	—	63908
QS18VP6FF50 QS18VP6FF50Q8			2 m 4-pin Euro QD	PNP			
QS18VN6FF100 QS18VN6FF100Q8		0-100 mm Cutoff	2 m 4-pin Euro QD	NPN	EGCF-5 (p. 441)	—	
QS18VP6FF100 QS18VP6FF100Q8			2 m 4-pin Euro QD	PNP			

\* Infrared LED    Visible Red LED    Visible Red Laser

\*\* For 9 m cable, add suffix **W/30** to the 2 m model number (example, **QS18VN6W W/30**). A model with a QD requires a mating cable (see pages 378 and 380).

**QD models** (except Adjustable-Field):

• For 4-pin integral Euro-style QD, add suffix **Q8** (example, **QS18VN6WQ8**).

• For 4-pin integral Pico-style QD, add suffix **Q7** (example, **QS18VN6WQ7**).

**QD models** (Adjustable-Field only):

• For 4-pin 150 mm Pico-style pigtail, add suffix **Q** (example, **QS18VP6AF100Q**).

• For 4-pin 150 mm Euro-style pigtail, add suffix **Q5** (example, **QS18VN6WQ5**).

• For 4-pin 150 mm Pico-style pigtail, add suffix **Q** (example, **QS18VN6WQ**).

• For 4-pin 150 mm Euro-style pigtail, add suffix **Q5** (example, **QS18VP6AF100Q5**).

**WORLD-BEAM® QS18, 10-30V dc (cont'd)**



Models	Sensing Mode/LED*	Range	Cable**	Output Type	Excess Gain	Beam Pattern	Data Sheet
QS18VN6F QS18VN6FQ8		Range varies by sensing mode and fiber optics used	2 m 4-pin Euro QD	NPN	EGCG-1 & EGCG-2 (p. 444)	BPG-1 & BPG-2 (p. 462)	63908
QS18VP6F QS18VP6FQ8			2 m 4-pin Euro QD				
QS18VN6FP QS18VN6FPQ8		Range varies by sensing mode and fiber optics used	2 m 4-pin Euro QD	NPN	EGCP-1 & EGCP-2 (p. 447)	BPP-1 & BPP-2 (p. 465)	63908
QS18VP6FP QS18VP6FPQ8			2 m 4-pin Euro QD				

\* Infrared LED    Visible Red LED

\*\* For 9 m cable, add suffix **W/30** to the 2 m model number (example, **QS18VN6F W/30**). A model with a QD requires a mating cable (see pages 378 and 380).

**QD models:**

• For 4-pin integral Euro-style QD, add suffix **Q8** (example, **QS18VN6FQ8**).

• For 4-pin integral Pico-style QD, add suffix **Q7** (example, **QS18VN6FQ7**).

• For 4-pin 150 mm Euro-style pigtail, add suffix **Q5** (example, **QS18VN6FQ5**).



• For 4-pin 150 mm Pico-style pigtail, add suffix **Q** (example, **QS18VN6FQ**).

**WORLD-BEAM® QS18 Specifications**

<b>Supply Voltage</b>	<p><b>Retroreflective, Diffuse and Adjustable-field Laser models:</b> 10 to 30V dc (10% max. ripple) at less than 15 mA, exclusive of load</p> <p><b>Laser Emitter models:</b> 10 to 30V dc (10% max. ripple) at less than 35 mA, exclusive of load</p> <p><b>All other models:</b> 10 to 30V dc (10% max. ripple) at less than 25 mA, exclusive of load</p>
<b>Laser Characteristics (Lasers only)</b>	<p><b>Wavelength:</b> 650 nm visible red Class 1 laser</p> <p><b>Pulse width:</b> 7 microseconds (<b>Laser Emitter models:</b> 5 microseconds)</p> <p><b>Rep rate:</b> 130 microseconds (<b>Laser Emitter models:</b> 27 microseconds)</p> <p><b>Pulse output power:</b> 0.065 mW (<b>Laser Emitter models:</b> less than 1.9 mW)</p>
<b>Supply Protection Circuitry</b>	Protected against reverse polarity and transient voltages
<b>Laser Control</b>	Enable beam by applying 0V dc to white wire; apply +10 to 30V dc to white wire to inhibit (extinguish) beam
<b>Output Configuration*</b>	<p><b>Solid-state complementary (SPDT);</b> NPN (current sinking) or PNP (current sourcing), depending on model;</p> <p><b>Rating:</b> 100 mA max. each output at 25° C</p> <p><b>OFF-state leakage current:</b></p> <p style="padding-left: 20px;"><b>Retroreflective, Diffuse and Adjustable-field Laser models:</b> NPN: less than 200 µA @ 30V dc PNP: less than 10 µA @ 30V dc</p> <p style="padding-left: 20px;"><b>Fixed-field models:</b> less than 200 µA @ 30V dc</p> <p style="padding-left: 20px;"><b>All others:</b> less than 50 µA @ 30V dc</p> <p><b>ON-state saturation voltage:</b></p> <p style="padding-left: 20px;"><b>Retroreflective, Diffuse and Adjustable-field Laser models:</b> NPN: less than 1.6V @ 100 mA PNP: less than 2.0V @ 100 mA</p> <p style="padding-left: 20px;"><b>All other models:</b> less than 1V @ 10 mA; less than 1.5V @ 100 mA</p> <p>Protected against false pulse on power-up and continuous overload or short circuit of outputs</p>
<b>Output Response Time*</b>	<p><b>Opposed models:</b> 750 microseconds ON; 375 microseconds OFF</p> <p><b>Retroreflective Laser, Diffuse Laser and Adjustable-field models:</b> 700 microseconds ON/OFF</p> <p><b>Fixed-field models:</b> 850 microseconds ON/OFF</p> <p><b>All other models:</b> 600 microseconds ON/OFF</p>
<b>Delay at Power-up</b>	<p><b>Laser Emitters:</b> 1.5 seconds</p> <p><b>Retroreflective, Diffuse and Adjustable-field Laser models:</b> 200 milliseconds; outputs do not conduct during this time.</p> <p><b>All others:</b> 100 milliseconds; outputs do not conduct during this time.</p>
<b>Repeatability*</b>	<p><b>Opposed models:</b> 100 microseconds</p> <p><b>Retroreflective and Diffuse Laser models:</b> 130 microseconds</p> <p><b>Adjustable-field models:</b> 175 microseconds</p> <p><b>Fixed-field models:</b> 160 microseconds</p> <p><b>All other models:</b> 150 microseconds</p>

\* Does not apply to laser emitter models.

**WORLD-BEAM® QS18 Specifications (cont'd)**

<b>Sensing Hysteresis*</b>	<p><b>Retroreflective Laser models:</b> 12% of range typical  <b>Diffuse Laser models:</b> 15% of range typical  <b>Adjustable-field models:</b> 0.5% of range typical at 20 mm cutoff                                            1% of range typical at 50 mm cutoff                                            3% of range typical at 100 mm cutoff</p> <p><b>Adjustable-field Laser models:</b> 1% range typical at 30 mm cutoff            2% range typical at 75 mm cutoff            5% range typical at 150 mm cutoff</p>												
<b>Adjustments*</b>	<p><b>Retroreflective, Retroreflective Laser, Convergent, Diffuse, Diffuse Laser and Glass Fiber Optic, Plastic Fiber Optic models:</b> Single-turn sensitivity (Gain) adjustment potentiometer  <b>Adjustable-field models:</b> five-turn adjustment screw sets cutoff distance between 20 and 100 mm (adjustable-field) or 30 and 150 mm (laser adjustable-field), clutched at both ends of travel</p>												
<b>Indicators</b>	<p><b>Laser Emitter models: Green LED:</b> Power applied</p> <p><b>All other models, 2 LED indicators:</b>  <b>Green ON steady:</b> Power ON  <b>Green flashing:</b> Output overloaded  <b>Yellow† ON steady:</b> Light sensed  <b>Yellow† flashing:</b> Marginal excess gain (1.0 to 1.5x excess gain) in the light condition  <b>†NOTE: Prior to date code 0223, the output indicator was red instead of yellow.</b></p>												
<b>Construction</b>	<p>ABS housing, rated IEC IP67; NEMA 6; acrylic lens cover (Laser Emitter models have PMMA window) 2.5 mm (adjustable-field only) and 3 mm mounting hardware included</p>												
<b>Connections</b>	<p>2 m or 9 m 4-wire PVC cable, or 4-pin 150 mm pigtail Pico-style QD (<b>Q</b>), or 4-pin 150 mm pigtail Euro-style QD (<b>Q5</b>), or 4-pin Integral Pico-style QD (<b>Q7</b>), or 4-pin Integral Euro-style QD (<b>Q8</b>), depending on model. See pages 378 and 380.</p>												
<b>Operating Conditions</b>	<table border="0"> <thead> <tr> <th></th> <th><b>Laser models</b></th> <th><b>Adjustable-field</b></th> <th><b>All others</b></th> </tr> </thead> <tbody> <tr> <td><b>Temperature:</b></td> <td>-10° to +50° C</td> <td>0° to +55° C</td> <td>-20° to +70° C</td> </tr> <tr> <td><b>Relative humidity:</b></td> <td colspan="3">90% @ 50° C (non-condensing)</td> </tr> </tbody> </table>		<b>Laser models</b>	<b>Adjustable-field</b>	<b>All others</b>	<b>Temperature:</b>	-10° to +50° C	0° to +55° C	-20° to +70° C	<b>Relative humidity:</b>	90% @ 50° C (non-condensing)		
	<b>Laser models</b>	<b>Adjustable-field</b>	<b>All others</b>										
<b>Temperature:</b>	-10° to +50° C	0° to +55° C	-20° to +70° C										
<b>Relative humidity:</b>	90% @ 50° C (non-condensing)												
<b>Laser Classification (Laser models only)</b>	<p>Class 1 laser product; complies with EN60825-1: 2001 and 21 CFR 1040.10, except deviations pursuant to Laser Notice 50, dated 7-26-01.</p>												
<b>Certifications</b>	<p><b>Laser models:</b>  <b>All other models:</b> </p>												
<b>Hookup Diagrams</b>	<p><b>Emitters:</b> DC03 (p. 476)      <b>NPN Models:</b> DC04 (p.476)      <b>PNP Models:</b> DC05 (p. 477)  <b>Laser Emitter Models:</b> SP01 (p. 489)</p>												

\* Does not apply to laser emitter models.

**Class 1 Laser Sensors**

Lasers that are safe under reasonably foreseeable conditions of operation, including the use of optical instruments for intrabeam viewing. Reference 60825-1 Amend. 2 © IEC:2001(E), section 8.2.

**For safe laser use:**

- Do not permit a person to stare at the laser from within the beam.
- Do not point the laser at a person's eye at close range.
- Locate open laser beam paths either above or below eye level, where practical.

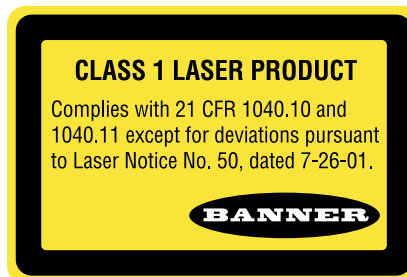

**WORLD-BEAM® QS18 Expert and Ultrasonic Sensors**

- Bright LED status indicators visible from 360°
- Simple push-button programming
- Optional 18 mm threaded lens mount on some models

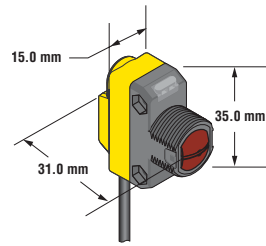

**Retroreflective, Convergent and Diffuse Models**  
Suffix LP, CV15, CV45 and D

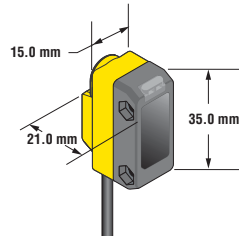

**Diffuse Models**  
Suffix DB and W

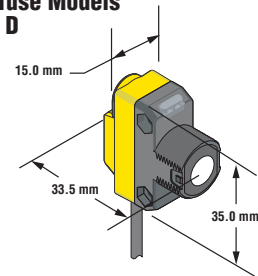

**Ultrasonic Models**  
Suffix NA and PA

**WORLD-BEAM® QS18 Expert™, 10-30V dc**



Models	Sensing Mode/LED*	Range	Cable**	Output Type	Excess Gain	Beam Pattern	Data Sheet
QS18EN6LP QS18EN6LPQ8	 POLAR RETRO	3.5 m†	2 m 4-pin Euro QD	NPN	EGCR-10 (p. 431)	BPR-9 (p. 453)	69948
QS18EP6LP QS18EP6LPQ8			2 m 4-pin Euro QD	PNP			
QS18EN6CV15 QS18EN6CV15Q8	 CONVERGENT	16 mm	2 m 4-pin Euro QD	NPN	EGCC-11 (p. 437)	BPC-11 (p. 459)	
QS18EP6CV15 QS18EP6CV15Q8			2 m 4-pin Euro QD	PNP			
QS18EN6CV45 QS18EN6CV45Q8	 CONVERGENT	43 mm	2 m 4-pin Euro QD	NPN	EGCC-12 (p. 437)	BPC-12 (p. 459)	
QS18EP6CV45 QS18EP6CV45Q8			2 m 4-pin Euro QD	PNP			
QS18EN6D QS18EN6DQ8	 DIFFUSE	800 mm	2 m 4-pin Euro QD	NPN	EGCD-10 (p. 434)	BPD-9 (p. 456)	
QS18EP6D QS18EP6DQ8			2 m 4-pin Euro QD	PNP			
QS18EN6DB QS18EN6DBQ8	 DIFFUSE	500 mm	2 m 4-pin Euro QD	NPN	EGCD-11 (p. 434)	BPD-10 (p. 456)	
QS18EP6DB QS18EP6DBQ8			2 m 4-pin Euro QD	PNP			

\* Infrared LED    Visible Red LED

\*\* For 9 m cable, add suffix **W/30** to the 2 m model number (example, **QS18EN6LP W/30**). A model with a QD requires a mating cable (see pages 378 and 380).

**QD models:**

- For 4-pin integral Euro-style QD, add suffix **Q8** (example, **QS18EN6LPQ8**).
- For 4-pin integral Pico-style QD, add suffix **Q7** (example, **QS18EN6LPQ7**).
- For 4-pin 150 mm Euro-style pigtail, add suffix **Q5** (example, **QS18EN6LPQ5**).
- For 4-pin 150 mm Pico-style pigtail, add suffix **Q** (example, **QS18EN6LPQ**).

† Retroreflective range is specified using one model BRT-84 retroreflector. Actual sensing range may differ, depending on the efficiency and reflective area of the retroreflector used. See Accessories for more information.



WORLD-BEAM® QS18 Expert™, 10-30V dc (cont'd)



Models	Sensing Mode/LED*	Range	Cable**	Output Type	Excess Gain	Beam Pattern	Data Sheet
QS18EN6W QS18EN6WQ8		300 mm	2 m 4-pin Euro QD	NPN	EGCD-12 (p. 434)	BPD-11 (p. 456)	69948
QS18EP6W QS18EP6WQ8			2 m 4-pin Euro QD	PNP			

WORLD-BEAM® QS18 Ultrasonic, 12-30V dc



Models†	Sensing Mode/LED*	Range	Cable**	Output Type	Excess Gain	Beam Pattern	Data Sheet
QS18UNA QS18UNAQ8		50 - 500 mm	2 m 4-pin Euro QD	NPN	—	—	119287
QS18UNAE†† QS18UNAEQ8††			2 m 4-pin Euro QD				
QS18UPA QS18UPAQ8			2 m 4-pin Euro QD	PNP	—	—	
QS18UPAE†† QS18UPAEQ8††			2 m 4-pin Euro QD				

\* Infrared LED     Ultrasonic

\*\* For 9 m cable, add suffix **W/30** to the 2 m model number (example, **QS18EN6W W/30**). A model with a QD requires a mating cable (see pages 378, 379 and 380).  
**QD models:**

- For 4-pin integral Euro-style QD, add suffix **Q8** (example, **QS18EN6WQ8**).
- For 4-pin integral Pico-style QD, add suffix **Q7** (example, **QS18EN6WDQ7**).
- For 4-pin 150 mm Euro-style pigtail, add suffix **Q5** (example, **QS18EN6WQ5**).
- For 4-pin 150 mm Pico-style pigtail, add suffix **Q** (example, **QS18EN6WQ**).

† For complete information see QS18U Ultrasonic Sensors on page 293.

†† Models are epoxy-encapsulated, DIN 40050, IP69K with remote Teach programming.

**WORLD-BEAM® QS18 Expert™ Specifications**

<b>Supply Voltage</b>	10 to 30V dc (10% max. ripple) at less than 35 mA, exclusive of load; 10 to 24V dc @ greater than 55° C
<b>Supply Protection Circuitry</b>	Protected against reverse polarity and transient voltages
<b>Output Configuration</b>	SPST solid-state NPN (current sinking) or PNP (current sourcing), depending on model. Configuration in TEACH sequence for light operate (LO) or dark operate (DO). <b>Rating:</b> 100 mA max. <b>OFF-state leakage current:</b> less than 50 µA @ 30V dc <b>ON-state saturation voltage:</b> less than 1.5V (2 m cable); 1.7V (9 m cable) Protected against false pulse on power-up and continuous overload or short circuit of output
<b>Output Response Time</b>	600 microseconds ON/OFF
<b>Delay at Power-up</b>	Less than 1 second; outputs do not conduct during this time
<b>Repeatability</b>	75 microseconds
<b>Adjustments</b>	Push button and remote wire <ul style="list-style-type: none"> <li>• <b>Thresholds:</b> Push-button/remote-wire teachable</li> <li>• <b>Light/dark operate:</b> Selectable by programming order (load output follows the first taught target condition)</li> <li>• <b>Push-button lockout</b> (remote wire only)</li> </ul>
<b>Indicators</b>	<b>2 LED indicators:</b> <b>Green:</b> RUN mode, output short-circuit <b>Red:</b> Output ON/marginal, TEACH mode
<b>Construction</b>	Polycarbonate/ABS housing and TPE push button, rated IEC IP67; NEMA 6 3 mm mounting hardware included
<b>Connections</b>	2 m or 9 m 4-wire PVC cable, or 4-pin 150 mm pigtail Pico-style QD ( <b>Q</b> ), or 4-pin 150 mm pigtail Euro-style QD ( <b>Q5</b> ), or 4-pin Integral Pico-style QD ( <b>Q7</b> ), or 4-pin Integral Euro-style QD ( <b>Q8</b> ). QD cables are ordered separately. See pages 378 and 380.
<b>Operating Conditions</b>	<b>Temperature:</b> -20° to +70° C <b>Relative humidity:</b> 90% @ 50° C (non-condensing)
<b>Application Note</b>	The first condition presented during TEACH mode becomes the OUTPUT ON condition.
<b>Certifications</b>	
<b>Hookup Diagrams</b>	<b>NPN Models:</b> DC09 (p. 478) <b>PNP Models:</b> DC10 (p. 478)

**WORLD-BEAM® QS18 Ultrasonic Specifications**

See page 295.



# MINI-BEAM®

## Broad Family of Compact Sensors

- Models are available for ac, dc, or ac/dc universal voltage operation.
- Available models include opposed, opposed clear plastic detection, diffuse and divergent diffuse, polarized and non-polarized retroreflective, convergent, glass and plastic fiber optic.
- Convergent and fiber optic models offer infrared or visible red, blue, white, or green LED light source; select a color based on the application.
- SME312 *Expert™* models offer easy, push-button TEACH-mode setup.
- MIAD9 series NAMUR models are for hazardous environments with approved switching amplifiers having intrinsically safe input circuits.
- MINI-BEAM models detect clear plastic; MINI-BEAM *Expert* models detect clear objects.

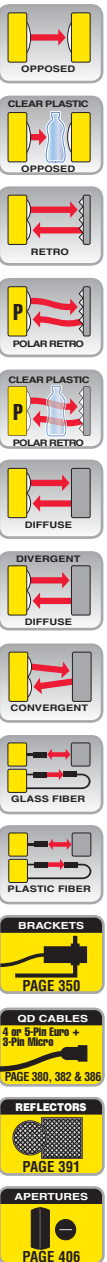

DC Models . . . . . Page 76  
 AC Models . . . . . 78  
 Expert Models . . . . . 81  
 Universal Voltage Models . . . . . 84  
 NAMUR Models . . . . . 86

### MINI-BEAM® DC Sensors

- Signal strength output indicator
- 10 to 30V dc with bipolar NPN/PNP outputs
- 2 m or 9 m integral cable, or Euro-style quick-disconnect fitting
- Optional 18 mm threaded lens mount on some models

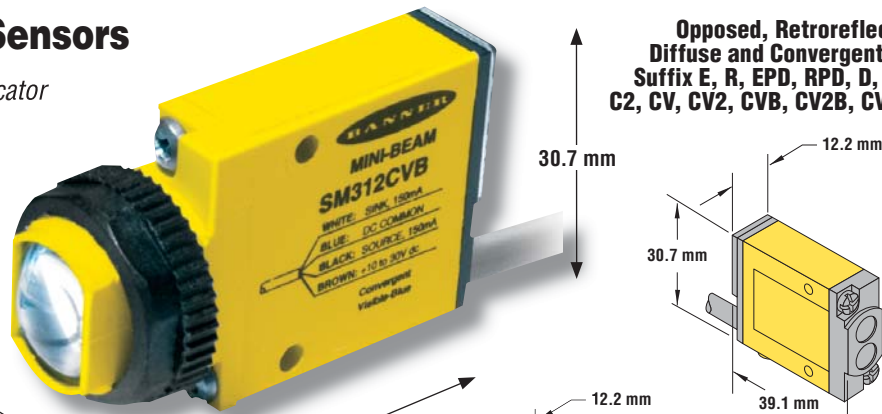

**Opposed, Retroreflective, Diffuse and Convergent Models**  
 Suffix E, R, EPD, RPD, D, LV, LP, C, C2, CV, CV2, CVB, CV2B, CVG and CV2G

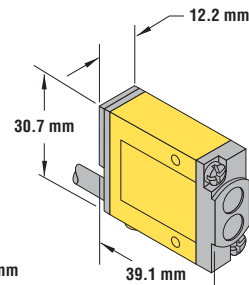

**Diffuse Models**  
 Suffix DBZ and W

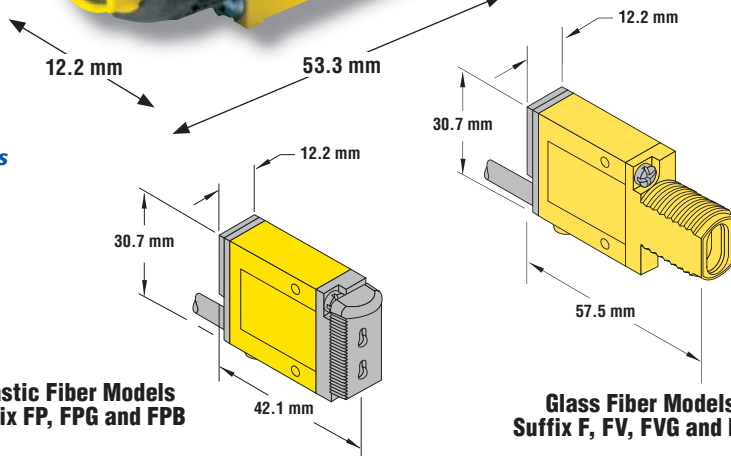

**Plastic Fiber Models**  
 Suffix FP, FPG and FPB

**Glass Fiber Models**  
 Suffix F, FV, FVG and FVB





**MINI-BEAM®, 10-30V dc**

Models	Sensing Mode/LED*	Range	Cable**	Output Type	Excess Gain	Beam Pattern	Data Sheet	
SM31E Emitter SM31EQD Emitter	OPPOSED	3 m	2 m 4-Pin Euro QD	<b>Bipolar NPN/PNP</b>	EGCO-10 (p. 428)	BPO-10 (p. 450)	03560	
SM31R SM31RQD			2 m 4-Pin Euro QD					
SM31EL Emitter SM31ELQD Emitter		30 m	2 m 4-Pin Euro QD		EGCO-11 (p. 428)	BPO-11 (p. 450)		
SM31RL SM31RLQD			2 m 4-Pin Euro QD					
SM31EPD Emitter SM31RPD Emitter	CLEAR PLASTIC OPPOSED	0.3 m	2 m		See Note Below***	03458		
SM31EPDQD SM31RPDQD			4-Pin Euro QD					
SM312LV SM312LVQD	RETRO	5 m†	2 m 4-Pin Euro QD		EGCR-11 (p. 431)	BPR-10 (p. 453)	03562	
SM312LVAG SM312LVAGQD	POLAR RETRO	50 mm - 2 m†	2 m 4-Pin Euro QD		EGCR-12 (p. 431)	BPR-11 (p. 453)		
SM312LP SM312LPQD	EXTENDED RANGE POLAR RETRO	10 mm - 3 m†	2 m 4-Pin Euro QD		EGCR-13 (p. 431)	BPR-12 (p. 453)		
SM312D SM312DQD	DIFFUSE	380 mm	2 m 4-Pin Euro QD		<b>Bipolar NPN/PNP</b>	EGCD-13 (p. 434)	BPD-12 (p. 456)	03366
SM312DBZ SM312DBZQD		300 mm	2 m 4-Pin Euro QD			EGCD-14 (p. 434)	BPD-13 (p. 456)	03564
SM312W SM312WQD	DIVERGENT DIFFUSE	130 mm	2 m 4-Pin Euro QD			EGCD-15 (p. 434)	BPD-14 (p. 456)	69943
SM312C SM312CQD	CONVERGENT	16 mm	2 m 4-Pin Euro QD			EGCC-13 (p. 437)	BPC-13 (p. 459)	
SM312C2 SM312C2QD		43 mm	2 m 4-Pin Euro QD			EGCC-14 (p. 437)	BPC-14 (p. 459)	
SM312CV SM312CVQD	CONVERGENT	16 mm	2 m 4-Pin Euro QD			EGCC-15 (p. 437)	BPC-15 (p. 459)	03365
SM312CV2 SM312CV2QD		43 mm	2 m 4-Pin Euro QD					
SM312CVG SM312CVGQD	CONVERGENT	16 mm	2 m 4-Pin Euro QD	EGCC-17 (p. 438)		BPC-17 (p. 460)	50975	
SM312CV2G SM312CV2GQD		49 mm	2 m 4-Pin Euro QD	EGCC-18 (p. 438)		BPC-18 (p. 460)		
SM312CVB SM312CVBQD	CONVERGENT	16 mm	2 m 4-Pin Euro QD	EGCC-19 (p. 438)		BPC-19 (p. 460)	49290	
SM312CV2B SM312CV2BQD		49 mm	2 m 4-Pin Euro QD					EGCC-20 (p. 438)

\* Infrared LED    Visible Red LED    Visible Green LED    Visible Blue LED

\*\* For 9 m cable, add suffix **W/30** to the 2 m model number (example, **SM312D W/30**). A model with a QD requires a mating cable (see page 380).

\*\*\* Actual range depends on light transmission through the plastic being sensed. Some clear plastic materials may not be detected. When in doubt, ask your Banner representative to evaluate material samples.

† Retroreflective range is specified using one model BRT-3 retroreflector. Actual sensing range may differ, depending on the efficiency and reflective area of the retroreflector used. See Accessories for more information.





# MINI-BEAM®, 10-30V dc (cont'd)

Models	Sensing Mode/LED*	Range	Cable**	Output Type	Excess Gain	Beam Pattern	Data Sheet
SM312F SM312FQD	GLASS FIBER	Range varies by sensing mode and fiber optics used	2 m 4-Pin Euro QD	Bipolar NPN/PNP	EGCG-3 & EGCG-4 (p. 444)	BPG-3 & BPG-4 (p. 462)	03368
SM312FV SM312FVQD	GLASS FIBER		2 m 4-Pin Euro QD		EGCG-5 & EGCG-6 (p. 444)	BPG-5 & BPG-6 (p. 462)	03510
SM312FVG SM312FVGQD	GLASS FIBER		2 m 4-Pin Euro QD		EGCG-7 (p. 444)	BPG-7 (p. 462)	50975
SM312FVB SM312FVBQD	GLASS FIBER		2 m 4-Pin Euro QD		EGCG-8 (p. 444)	BPG-8 (p. 462)	49290
SM312FP SM312FPQD	PLASTIC FIBER		2 m 4-Pin Euro QD		EGCP-3 & EGCP-4 (p. 447)	BPP-3 & BPP-4 (p. 465)	03370
SM312FPG SM312FPGQD	PLASTIC FIBER		2 m 4-Pin Euro QD		EGCP-5 (p. 447)	BPP-5 (p. 465)	50975
SM312FPB SM312FPBQD	PLASTIC FIBER		2 m 4-Pin Euro QD		EGCP-6 (p. 447)	BPP-6 (p. 465)	49290

\* Infrared LED    Visible Red LED    Visible Green LED    Visible Blue LED

\*\* For 9 m cable, add suffix **W/30** to the 2 m model number (example, **SM312F W/30**). A model with a QD requires a mating cable (see page 380).

## MINI-BEAM® DC Specifications

<b>Supply Voltage and Current</b>	10 to 30V dc (10% max. ripple) at less than 25 mA (exclusive of load)
<b>Supply Protection Circuitry</b>	Protected against reverse polarity and transient voltages
<b>Output Configuration</b>	<b>Bipolar:</b> One current sourcing (PNP) and one current sinking (NPN) open-collector transistor; light operate (LO) or dark operate (DO) selectable.
<b>Output Rating</b>	150 mA max. each output at 25° C, derated to 100 mA at 70° C (derate ≈ 1 mA per ° C) <b>Off-state leakage current:</b> less than 1 µA <b>Output saturation voltage (PNP output):</b> less than 1 volt at 10 mA and less than 2 volts at 150 mA <b>Output saturation voltage (NPN output):</b> less than 200 millivolts at 10 mA and less than 1 volt at 150 mA
<b>Output Protection Circuitry</b>	Protected against false pulse on power-up and continuous overload or short-circuit of outputs
<b>Output Response Time</b>	Sensors will respond to either a "light" or a "dark" signal of 1 millisecond or longer duration, 500 Hz max. 0.3 millisecond response modification is available. See note below. NOTE: 100 millisecond delay on power-up: outputs do not conduct during this time.
<b>Repeatability</b>	<b>Opposed:</b> 0.14 milliseconds; <b>Non-Polarized and Polarized Retroreflective, Diffuse, Convergent, Glass and Plastic Fiber Optic:</b> 0.3 milliseconds. Response time and repeatability specifications are independent of signal strength.
<b>Adjustments</b>	LIGHT/DARK OPERATE select switch, and 15-turn slotted brass screw GAIN (sensitivity) adjustment potentiometer (clutched at both ends of travel). Both controls are located on rear panel of sensor and protected by a gasketed, clear acrylic cover.
<b>Indicators</b>	Alignment Indicating Device system (AID) lights a rear-panel mounted red LED indicator whenever the sensor sees a "light" condition, with a superimposed pulse rate proportional to the light signal strength (the stronger the signal, the faster the pulse rate).
<b>Construction</b>	Reinforced thermoplastic polyester housing, totally encapsulated, o-ring sealing, acrylic lenses, and stainless steel screws.
<b>Environmental Rating</b>	Meets NEMA standards 1, 2, 3, 3S, 4, 4X, 6, 12, and 13; IEC IP67
<b>Connections</b>	PVC-jacketed 4-conductor 2 m or 9 m cables, or 4-pin Euro-style quick-disconnect (QD) fitting are available. QD cables are ordered separately. See page 380.
<b>Operating Conditions</b>	<b>Temperature:</b> -20° to +70° C <b>Relative humidity:</b> 90% at 50° C (non-condensing)
<b>Certifications</b>	
<b>Hookup Diagrams</b>	<b>Emitters:</b> DC03 (p. 476) <b>Other Models:</b> DC06 (p. 477)

\*NOTE: DC MINI-BEAMS may be ordered with 0.3 millisecond on/off response by adding suffix **MHS** to the model number (example, **SM312LVMHS**). This modification reduces sensing range (and excess gain).

# MINI-BEAM® Series

Compact Sensors

PHOTOELECTRICS

## MINI-BEAM® AC Sensors

- Signal strength or output indicator
- 24 to 240V ac with solid-state outputs
- 2 m or 9 m integral cable, quick-disconnect fitting or Micro-style QD
- Optional 18 mm threaded lens mount on some models



Opposed, Retroreflective, Diffuse and Convergent Models  
Suffix E, R, EPD, RPD, D, LV, LP, C and CV

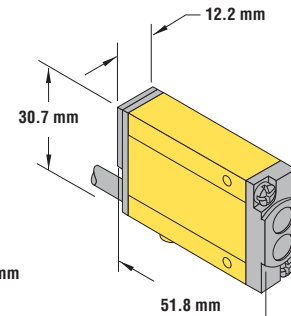

Diffuse Models  
Suffix DBZ and W

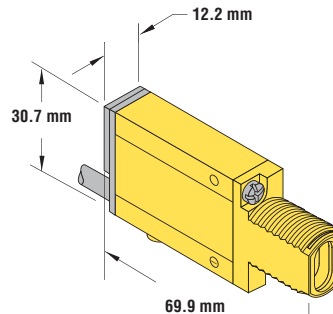

Glass Fiber Models  
Suffix F and FV

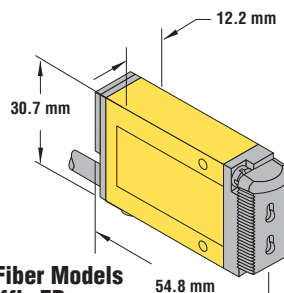

Plastic Fiber Models  
Suffix FP



## MINI-BEAM®, 24-240V ac



Models	Sensing Mode/LED*	Range	Cable**	Output Type	Excess Gain	Beam Pattern	Data Sheet
SMA31E Emitter SMA31EQD Emitter	 OPPOSED	3 m	2 m	SPST Solid-State 2-Wire	EGCO-10 (p. 428)	BPO-10 (p. 450)	03561
SM2A31R SM2A31RQD			3-Pin Micro QD				
SMA31EL Emitter SMA31ELQD Emitter		30 m	2 m		EGCO-11 (p. 428)	BPO-11 (p. 450)	
SM2A31RL SM2A31RLQD			3-Pin Micro QD				
SMA31EPD Emitter SM2A31RPD	 OPPOSED	0.3 m	2 m		See Note Below***	03458	
SMA31EPDQD Emitter SM2A31RPDQD			3-Pin Micro QD				
SM2A312D SM2A312DQD	 DIFFUSE	380 mm	2 m		EGCD-13 (p. 434)	BPD-12 (p. 456)	03376
SM2A312DBZ SM2A312DBZQD		300 mm	2 m		EGCD-14 (p. 434)	BPD-13 (p. 456)	03565
SM2A312W SM2A312WQD	 DIFFUSE	130 mm	2 m	EGCD-15 (p. 434)	BPD-14 (p. 456)	03565	

\* Infrared LED    Visible Red LED

\*\* For 9 m cable, add suffix **W/30** to the 2 m model number (example, **SM2A312D W/30**). A model with a QD requires a mating cable (see page 386).

\*\*\* Actual range depends on light transmission through the plastic being sensed. Some clear plastic materials may not be detected. When in doubt, ask your Banner representative to evaluate material samples.



MINI-BEAM®, 24-240V ac (cont'd)

Models	Sensing Mode/LED*	Range	Cable**	Output Type	Excess Gain	Beam Pattern	Data Sheet	
SM2A312LV SM2A312LVQD	RETRO	5 m†	2 m 3-Pin Micro QD	SPST Solid-state 2-Wire	EGCR-11 (p. 431)	BPR-10 (p. 453)	03563	
SM2A312LVAG SM2A312LVAGQD	POLAR RETRO	50 mm - 2 m†	2 m 3-Pin Micro QD		EGCR-12 (p. 431)	BPR-11 (p. 453)		
SM2A312LP SM2A312LPQD	EXTENDED RANGE POLAR RETRO	10 mm - 3 m†	2 m 3-Pin Micro QD		EGCR-13 (p. 431)	BPR-12 (p. 453)		
SM2A312C SM2A312CQD	CONVERGENT	16 mm	2 m 3-Pin Micro QD		EGCC-13 (p. 437)	BPC-13 (p. 459)	69942	
SM2A312C2 SM2A312C2QD		43 mm	2 m 3-Pin Micro QD		EGCC-14 (p. 437)	BPC-14 (p. 459)		
SM2A312CV SM2A312CVQD	CONVERGENT	16 mm	2 m 3-Pin Micro QD		EGCC-15 (p. 437)	BPC-15 (p. 459)	03402	
SM2A312CV2 SM2A312CV2QD		43 mm	2 m 3-Pin Micro QD		EGCC-16 (p. 437)	BPC-16 (p. 459)		
SM2A312CVG SM2A312CVGQD	CONVERGENT	16 mm	2 m 3-Pin Micro QD		EGCC-17 (p. 438)	BPC-17 (p. 460)	69942	
SM2A312F SM2A312FQD	GLASS FIBER	Range varies by sensing mode and fiber optics used	2 m		3-Pin Micro QD	EGCG-3 & EGCG-4 (p. 444)	BPG-3 & BPG-4 (p. 462)	03375
SM2A312FV SM2A312FVQD			2 m					
SM2A312FP SM2A312FPQD	PLASTIC FIBER	Range varies by sensing mode and fiber optics used	2 m 3-Pin Micro QD	EGCP-3 & EGCP-4 (p. 447)	BPP-3 & BPP-4 (p. 465)	03404		

\* Infrared LED Visible Red LED Visible Green LED

\*\* For 9 m cable, add suffix **W/30** to the 2 m model number (example, **SM2A312LP W/30**). A model with a QD requires a mating cable (see page 386).

† Retroreflective range is specified using one model BRT-3 retroreflector. Actual sensing range may differ, depending on the efficiency and reflective area of the retroreflector used. See Accessories for more information.

**MINI-BEAM® AC Specifications**

<b>Supply Voltage and Current</b>	24 to 240V ac (50/60 Hz), 250V ac max
<b>Supply Protection Circuitry</b>	Protected against transient voltages
<b>Output Configuration</b>	SPST SCR solid-state relay (light/dark operate selectable); 2-wire hookup
<b>Output Rating</b>	Min. load current 5 mA; max. steady-state load capability 300 mA to 50° C ambient 100 mA to 70° C ambient <b>Inrush capability:</b> 3 amps for 1 second (non repetitive); 10 amps for 1 cycle (non repetitive) <b>Off-state leakage current:</b> less than 1.7 mA rms <b>On-state voltage drop:</b> ≤ 5 volts at 300 mA load, ≤ 10 volts at 15 mA load
<b>Output Protection Circuitry</b>	Protected against false pulse on power-up
<b>Output Response Time</b>	<b>Opposed Mode:</b> 2 milliseconds on and 1 millisecond off; <b>Non-Polarized and Polarized Retroreflective, Convergent, Plastic Fiber Optic:</b> 4 milliseconds on and off; <b>Diffuse and Glass Fiber Optic:</b> 8 milliseconds on and off “OFF” response time specification does not include load response of up to ½ ac cycle (8.3 milliseconds). Response time specification of load should be considered when important. NOTE: 300 millisecond delay on power-up.
<b>Repeatability</b>	<b>Opposed:</b> 0.3 milliseconds <b>Non-Polarized and Polarized Retroreflective, and Convergent and Plastic Fiber Optic:</b> 1.3 milliseconds <b>Diffuse and Glass Fiber Optics:</b> 2.6 milliseconds Response time and repeatability specifications are independent of signal strength.
<b>Adjustments</b>	LIGHT/DARK OPERATE select switch, and 15-turn slotted brass screw GAIN (sensitivity) adjustment potentiometer (clutched at both ends of travel). Both controls are located on rear panel of sensor and protected by a gasketed, clear acrylic cover.
<b>Indicators</b>	Red indicator LED on rear of sensor is “ON” when the load is energized
<b>Construction</b>	Reinforced thermoplastic polyester housing, totally encapsulated, o-ring sealing, acrylic lenses, and stainless steel screws
<b>Environmental Rating</b>	Meets NEMA standards 1, 2, 3, 3S, 4, 4X, 6, 12, and 13; IEC IP67
<b>Connections</b>	PVC-jacketed 2-conductor 2 m or 9 m cables, or 3-pin micro-style quick-disconnect (QD) fitting are available. QD cables are ordered separately. See page 386.
<b>Operating Conditions</b>	<b>Temperature:</b> -20° to +70° C <b>Relative humidity:</b> 90% at 50° C (non-condensing)
<b>Application Notes</b>	i) Overload conditions can destroy ac MINI-BEAM sensors. Directly wiring sensor without load series across hot and neutral will damage sensor (except emitter models). ii) Low voltage use requires careful analysis of the load to determine if the leakage current or on-state voltage of the sensor will interfere with proper operation of the load. iii) The false-pulse protection feature may cause momentary drop-out of the load when the sensor is wired in series or parallel with mechanical switch contacts.
<b>Certifications</b>	
<b>Hookup Diagrams</b>	<b>Cabled Emitters:</b> AC03 (p. 484) <b>All Other QD Models:</b> AC02 (p. 484) <b>QD Emitters:</b> AC04 (p. 484) <b>All Other Cabled Models:</b> AC01 (p. 484)



# MINI-BEAM® Expert™ Sensors

- Simple push-button programming or remote TEACH via wire
- Dual-LED multi-function indicators
- 2 m or 9 m integral cable, or Euro-style quick disconnect fitting
- Popular 18 mm threaded lens mount



Retroreflective, Diffuse and Convergent Models  
Suffix LV, LP, D, DV, CV, CV2, CVG, CVB and CVW

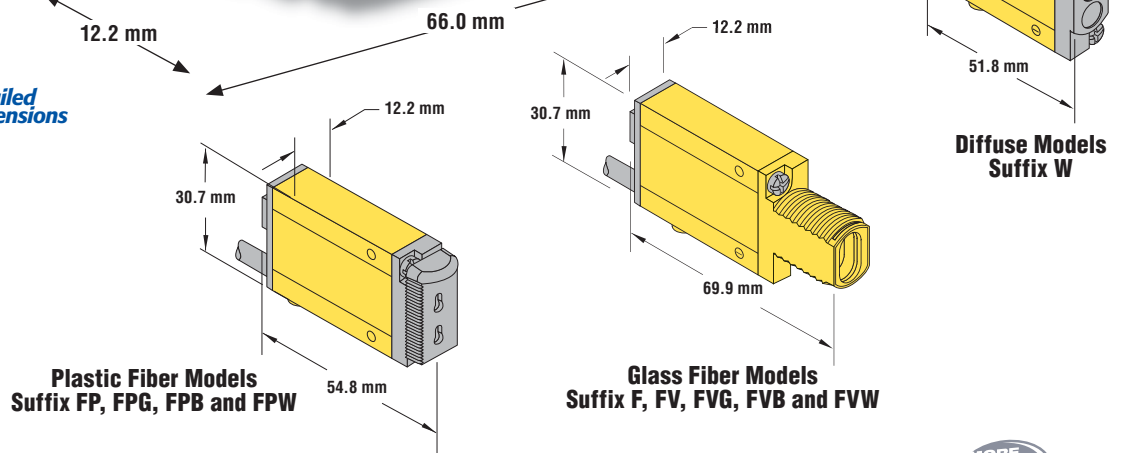

## MINI-BEAM® Expert™, 10-30V dc



Models	Sensing Mode/LED*	Range	Cable**	Output Type	Excess Gain	Beam Pattern	Data Sheet
SME312LP SME312LPQD	POLAR RETRO	10 mm - 3 m†	2 m 5-Pin Euro QD	Bipolar NPN/PNP	EGCR-14 (p. 431)	BPR-13 (p. 453)	55214
SME312LPC*** SME312LPCQD***	CLEAR OBJECT POLAR RETRO	1 m	2 m 5-Pin Euro QD		EGCR-15 (p. 431)	BPR-14 (p. 453)	
SME312D SME312DQD	DIFFUSE	380 mm	2 m 5-Pin Euro QD		EGCD-16 (p. 434)	BPD-15 (p. 456)	55214
SME312DV SME312DVQD	DIFFUSE	1100 mm	2 m 5-Pin Euro QD		EGCD-18 (p. 435)	BPD-17 (p. 457)	
SME312W SME312WQD	DIVERGENT DIFFUSE	130 mm	2 m 5-Pin Euro QD		EGCD-17 (p. 435)	BPD-16 (p. 456)	

\* Infrared LED    Visible Red LED

\*\* For 9 m cable, add suffix **W/30** to the 2 m model number (example, **SME312D W/30**). A model with a QD requires a mating cable (see page 382).

\*\*\* NOTE: For clear object detection, sensing range varies, according to the efficiency and reflective area of the retroreflector(s) used. For these low-contrast applications, the model BRT-2X2 reflector is recommended and is included with each SME312LPC(QD) sensor.

- For applications with high vibration, the model BRT-51x51BM, with its micro-prism geometry, is recommended.
- For long-range applications, the BRT-77X77C reflector provides a range up to 2 m.
- SME312LPC(QD) are for use with corner cube type reflectors only; reflective tape is not recommended. See page 391 for more information.

† NOTE: Retroreflective range is specified using one model BRT-3 retroreflector, unless otherwise noted. Actual sensing range may differ, depending on the efficiency and reflective area of the retroreflector used. See Accessories section for more information.

**MINI-BEAM® Expert™, 10-30V dc (cont'd)**



Models	Sensing Mode/LED*	Range	Cable**	Output Type	Excess Gain	Beam Pattern	Data Sheet
SME312CV SME312CVQD	CONVERGENT	16 mm	2 m 5-Pin Euro QD	Bipolar NPN/PNP	EGCC-21 (p. 438)	BPC-21 (p. 460)	55214
SME312CV2 SME312CV2QD	CONVERGENT	43 mm	2 m 5-Pin Euro QD		EGCC-22 (p. 438)	BPC-22 (p. 460)	
SME312CVG SME312CVGQD	CONVERGENT	16 mm	2 m 5-Pin Euro QD		EGCC-23 (p. 438)	BPC-23 (p. 460)	
SME312CVB SME312CVBQD	CONVERGENT	16 mm	2 m 5-Pin Euro QD		EGCC-24 (p. 438)	BPC-24 (p. 460)	
SME312CVW SME312CVWQD	CONVERGENT	16 mm	2 m 5-Pin Euro QD		EGCC-25 (p. 438)	BPC-25 (p. 460)	
SME312F SME312FQD	GLASS FIBER	Range varies by sensing mode and fiber optics used	2 m 5-Pin Euro QD		EGCG-9 & EGCG-10 (p. 444)	BPG-9 & BPG-10 (p. 462)	
SME312FV SME312FVQD	GLASS FIBER		2 m 5-Pin Euro QD		EGCG-11 & EGCG-12 (p. 444)	BPG-11 & BPG-12 (p. 462)	
SME312FVG SME312FVGQD	GLASS FIBER		2 m 5-Pin Euro QD		EGCG-13 (p. 444)	BPG-13 (p. 462)	
SME312FVB SME312FVBQD	GLASS FIBER		2 m 5-Pin Euro QD		EGCG-14 (p. 444)	BPG-14 (p. 462)	
SME312FVW SME312FVWQD	GLASS FIBER		2 m 5-Pin Euro QD		EGCG-15 (p. 444)	BPG-15 (p. 462)	
SME312FP SME312FPQD	PLASTIC FIBER		Range varies by sensing mode and fiber optics used	2 m 5-Pin Euro QD	EGCP-7 & EGCP-8 (p. 447)	BPP-7 & BPP-8 (p. 465)	55214
SME312FPG SME312FPGQD	PLASTIC FIBER	2 m 5-Pin Euro QD		EGCP-9 (p. 447)	BPP-9 (p. 465)		
SME312FPB SME312FPBQD	PLASTIC FIBER	2 m 5-Pin Euro QD		EGCP-10 (p. 447)	BPP-10 (p. 465)		
SME312FPW SME312FPWQD	PLASTIC FIBER	2 m 5-Pin Euro QD		EGCP-11 (p. 447)	BPP-11 (p. 465)		

\* Infrared LED    Visible Red LED    Visible Green LED    Visible Blue LED    Visible White LED

\*\* For 9 m cable, add suffix **W/30** to the 2 m model number (example, **SME312CV W/30**). A model with a QD requires a mating cable (see page 382).

## MINI-BEAM® Expert™ Specifications

<b>Supply Voltage and Current</b>	10 to 30V dc (10% max. ripple) at less than 45 mA, exclusive of load
<b>Supply Protection Circuitry</b>	Protected against reverse polarity and transient voltages
<b>Output Configuration</b>	<b>Bipolar:</b> One current sourcing (PNP) and one current sinking (NPN) open-collector transistor. Configuration in TEACH sequence for Light Operate (LO) or Dark Operate (DO).
<b>Output Rating</b>	150 mA max. each output at 25° C, derated to 100 mA at 70° C (derate $\approx$ 1 mA per ° C) <b>Off-state leakage current:</b> less than 5 $\mu$ A @ 30V dc <b>Output saturation voltage (PNP output):</b> less than 1 volt at 10 mA and less than 2 volts at 150 mA <b>Output saturation voltage (NPN output):</b> less than 200 millivolts at 10 mA and less than 1 volt at 150 mA
<b>Output Protection Circuitry</b>	Protected against false pulse on power-up and continuous overload or short-circuit of outputs
<b>Output Response Time</b>	Sensors will respond to either a “light” or a “dark” signal of 500 microseconds or longer duration, 1 kHz max. NOTE: 1 second delay on power-up; outputs do not conduct during this time.
<b>Repeatability</b>	100 microseconds (all models)
<b>Adjustments</b>	Push-button TEACH mode sensitivity setting; remote TEACH mode input is provided (gray wire)
<b>Indicators</b>	<b>Two LEDs:</b> Yellow and Bicolor Green/Red  <b>Green (RUN Mode):</b> ON when power is applied Flashes when received light level approaches the switching threshold <b>Red (TEACH Mode):</b> OFF when no signal is received. Pulses to indicate signal strength (received light level). Rate is proportional to signal strength (the stronger the signal, the faster the pulse rate). This is a function of Banner’s Alignment Indicating Device (AID). <b>Yellow (TEACH Mode):</b> ON to indicate sensor is ready to learn output ON condition OFF to indicate sensor is ready to learn output OFF condition <b>Yellow (RUN Mode):</b> ON when outputs are conducting
<b>Construction</b>	Reinforced thermoplastic polyester housing, totally encapsulated, o-ring seal, acrylic lenses, and stainless steel screws.
<b>Environmental Rating</b>	Meets NEMA standards 1, 2, 3, 3S, 4, 4X, 6, 12, and 13; IEC IP67
<b>Connections</b>	PVC-jacketed 5-conductor 2 m or 9 m unterminated cable, or 5-pin Euro-style quick-disconnect (QD) fitting are available. QD cables are ordered separately. See page 382.
<b>Operating Conditions</b>	<b>Temperature:</b> -20° to +70° C <b>Relative humidity:</b> 90% at 50° C (non-condensing)
<b>Application Notes</b>	The first condition presented during TEACH mode becomes the output ON condition.
<b>Certifications</b>	
<b>Hookup Diagrams</b>	DC11 (p. 478)

# MINI-BEAM® Universal Voltage Series

Compact Sensors



PHOTOELECTRICS

## MINI-BEAM® Universal Voltage Sensors

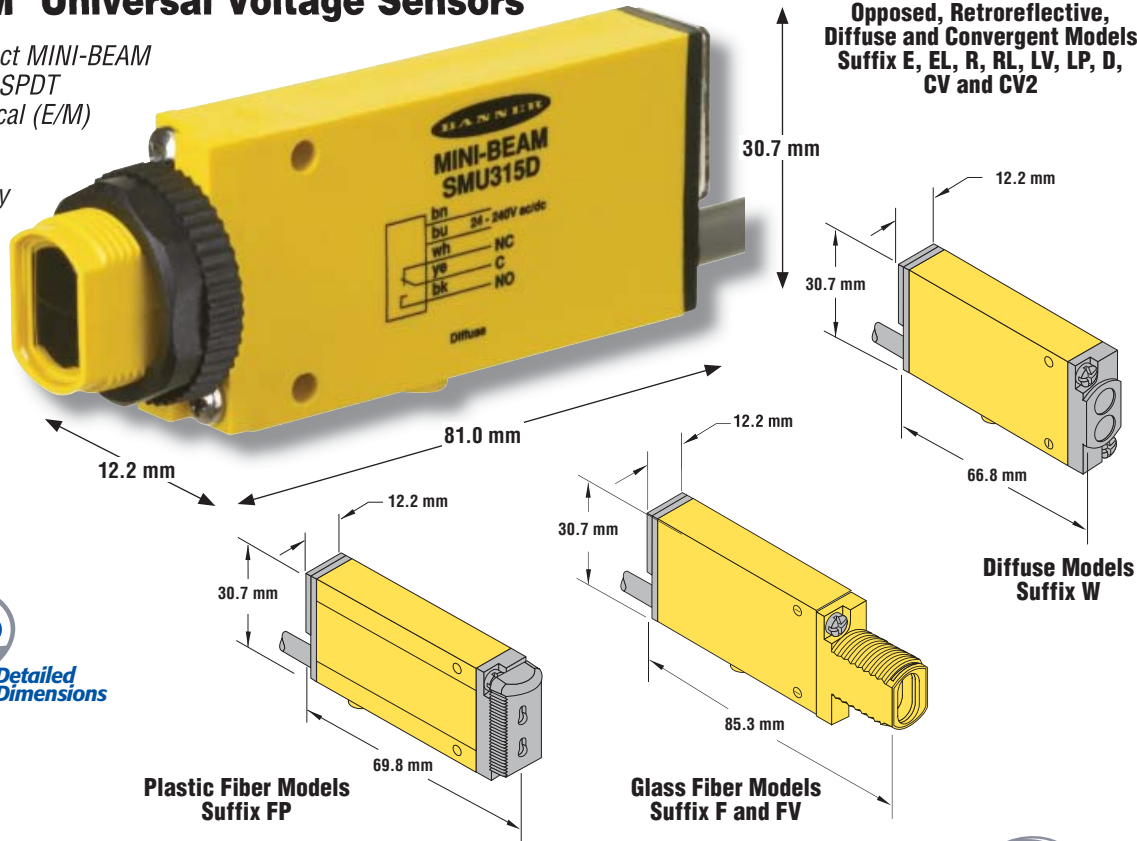
- Popular, compact MINI-BEAM package with a SPDT electromechanical (E/M) relay
- Universal supply voltage: 24 to 240V ac, 50/60 Hz; 24 to 240V dc
- Easy-to-operate sensors with few required adjustments

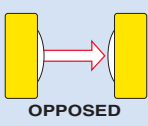

## MINI-BEAM® Universal Voltage, 24-240V ac or dc

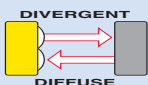
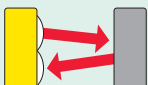
Models	Sensing Mode/LED*	Range	Cable**	Output Type	Excess Gain	Beam Pattern	Data Sheet		
SMU31E Emitter	 OPPOSED	3 m	2 m	SPDT E/M Relay	EGCO-12 (p. 428)	BPO-12 (p. 450)	55230		
SMU31R		30 m	2 m		EGCO-13 (p. 428)	BPO-13 (p. 450)			
SMU31EL Emitter					5 m†	2 m		EGCR-16 (p. 431)	BPR-15 (p. 453)
SMU31RL								EGCR-17 (p. 432)	BPR-16 (p. 453)
SMU315LV	 POLAR RETRO	10 mm - 3 m†	2 m		EGCD-19 (p. 435)	BPD-18 (p. 457)			
SMU315LP		380 mm	2 m		EGCD-20 (p. 435)	BPD-19 (p. 457)			
SMU315D	 DIVERGENT DIFFUSE	130 mm	2 m		EGCC-26 (p. 438)	BPC-26 (p. 460)			
SMU315W		16 mm	2 m		EGCC-27 (p. 438)	BPC-27 (p. 460)			
SMU315CV	 CONVERGENT	43 mm	2 m						
SMU315CV2									

\*  Infrared LED     Visible Red LED

\*\* For 9 m cable, add suffix **W/30** to the 2 m model number (example, **SMU315D W/30**).

† Retroreflective range is specified using one model BRT-3 retroreflector. Actual sensing range may differ, depending on the efficiency and reflective area of the retroreflector used. See Accessories for more information.





# MINI-BEAM® Universal Voltage, 24-240V ac or dc (cont'd)

Models	Sensing Mode/LED*	Range	Cable**	Output Type	Excess Gain	Beam Pattern	Data Sheet
SMU315F	GLASS FIBER	Range varies by sensing mode and fiber optics used	2 m	SPDT E/M Relay	EGCG-16 (p. 444) & EGCG-17 (p. 445)	BPG-16 (p. 462) & BPG-17 (p. 463)	55230
SMU315FV	GLASS FIBER		2 m		EGCG-18 & EGCG-19 (p. 445)	BPG-18 & BPG-19 (p. 463)	
SMU315FP	PLASTIC FIBER	Range varies by sensing mode and fiber optics used	2 m		EGCP-12 & EGCP-13 (p. 447)	BPP-12 & BPP-13 (p. 465)	

\* Infrared LED    Visible Red LED  
 \*\* For 9 m cable, add suffix **W/30** to the 2 m model number (example, **SMU315F W/30**).

## MINI-BEAM® Universal Voltage Specifications

Supply Voltage	<b>Universal voltage:</b> 24 to 240V ac, 50/60Hz or 24 to 240V dc (1.5 watts or 2.5 VA max.)
Supply Protection Circuitry	Protected against transient voltages. DC hookup is without regard to polarity.
Output Configuration	SPDT (Single-Pole, Double Throw) (form C) electromechanical relay, ON/OFF output.
Output Rating	<b>Max. switching power (resistive load):</b> 90W, 250VA <b>Max. switching voltage (resistive load):</b> 250V ac or 30V dc <b>Max. switching current (resistive load):</b> 3A <b>Min. voltage and current:</b> 5V dc, 10 mA <b>Mechanical life:</b> 20,000,000 operations <b>Electrical life at full resistive load:</b> 100,000 operations
Output Protection Circuitry	Protected against false pulse on power-up.
Output Response Time	<b>Closure time:</b> 20 milliseconds max. <b>Release time:</b> 20 milliseconds max. <b>Max. switching speed:</b> 25 operations per second
Repeatability	<b>All sensing modes:</b> 1 millisecond
Adjustments	Light/Dark Operate select switch, and 15-turn slotted brass screw Gain (sensitivity) adjustment potentiometer (clutched at both ends of travel). Both controls are located on rear panel of sensor and are protected by a gasketed, clear acrylic cover.
Indicators	Alignment Indicator Device system (AID) lights a rear-panel-mounted LED indicator whenever the sensor sees a "light" condition, with a superimposed pulse rate proportional to the light signal strength (the stronger the signal, the faster the pulse rate).
Construction	Reinforced thermoplastic polyester housing, totally encapsulated, o-ring seal, acrylic lenses, and stainless steel screws.
Environmental Rating	Meets NEMA standards 1, 2, 3, 3S, 4, 4X, 6, 12, and 13; IEC IP67.
Connections	PVC-jacketed 5-conductor 2 m or 9 m unterminated cable. Opposed mode emitter cables are 2-conductor.
Operating Conditions	<b>Temperature:</b> -20° to +55° C <b>Relative humidity:</b> 90% at 50° C (non-condensing)
Application Notes	Install transient suppressor (MOV) across contacts switching inductive loads.
Certifications	
Hookup Diagrams	<b>Emitters:</b> UN02 (p. 487) <b>Other AC/DC Models:</b> UN01 (p. 487)

# MINI-BEAM® NAMUR Series

Compact Sensors

PHOTOELECTRICS

## MINI-BEAM® NAMUR Sensors

- Intrinsically safe sensors with MINI-BEAM performance and small size
- For use with approved switching amplifiers with intrinsically safe input circuits
- Output 1 mA or less in the dark and 2 mA or more in the light
- Models with integral cable or quick-disconnect

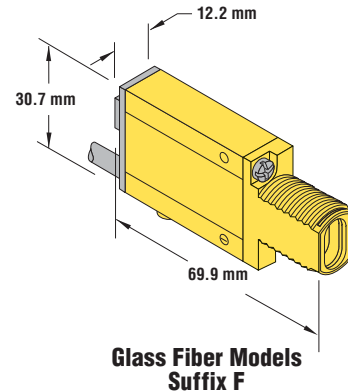
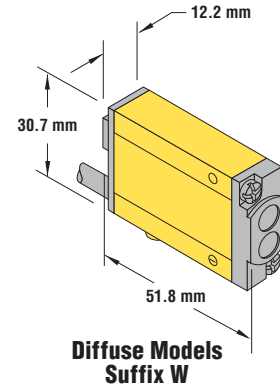

Opposed, Retroreflective, Diffuse and Convergent Models  
Suffix E, R, LV, D, and CV







## MINI-BEAM® NAMUR, 5-15V dc

Models	Sensing Mode/LED*	Range	Cable**	Output Type	Excess Gain	Beam Pattern	Data Sheet		
MI9E Emitter MI9EQ Emitter		6 m	2 m 4-Pin Euro QD	Constant Current ≤1.2 mA dark ≥2.1 mA light	EGCO-14 (p. 428)	BPO-14 (p. 450)	39616		
MIAD9R MIAD9RQ			2 m 4-Pin Euro QD						
MIAD9LV MIAD9LVQ		5 m	2 m 4-Pin Euro QD					EGCR-18 (p. 432)	BPR-17 (p. 454)
MIAD9LVAG MIAD9LVAGQ		50 mm - 2 m	2 m 4-Pin Euro QD					EGCR-19 (p. 432)	BPR-18 (p. 454)
MIAD9D MIAD9DQ		380 mm	2 m 4-Pin Euro QD					EGCD-21 (p. 435)	BPD-20 (p. 457)
MIAD9W MIAD9WQ		75 mm	2 m 4-Pin Euro QD					EGCD-22 (p. 435)	BPD-21 (p. 457)
MIAD9CV MIAD9CVQ		16 mm	2 m 4-Pin Euro QD					EGCC-28 (p. 438)	BPC-28 (p. 460)
MIAD9CV2 MIAD9CV2Q		43 mm	2 m 4-Pin Euro QD					EGCC-29 (p. 438)	BPC-29 (p. 460)
MIAD9F MIAD9FQ		Range varies by sensing mode and fiber optics used	2 m 4-Pin Euro QD					EGCG-20 & EGCG-21 (p. 445)	BPG-20 & BPG-21 (p. 463)

\* Infrared LED Visible Red LED

\*\* For 9 m cable, add suffix W/30 to the 2 m model number (example, MIAD9LV W/30). A model with a QD requires a special 4-pin Euro QD mating cable (see page 381).

† Retroreflective range is specified using one model BRT-3 retroreflector. Actual sensing range may differ, depending on the efficiency and reflective area of the retroreflector used. See Accessories for more information.

<b>MINI-BEAM® NAMUR Specifications</b>	
<b>Supply Voltage</b>	5 to 15V dc (provided by the amplifier to which the sensor is connected)
<b>Output</b>	<b>Constant current output:</b> ≤ 1.2 mA in the “dark” condition and ≤ 2.1 mA in the “light” condition
<b>Output Response Time</b>	<b>Opposed mode receiver:</b> 2 milliseconds on/400 microseconds off <b>All other models:</b> 5 milliseconds on/off (does not include amplifier response)
<b>Adjustments</b>	15-turn slotted brass screw GAIN (sensitivity) adjustment potentiometer (clutched at both ends of travel); located on rear panel and protected by a clear gasketed acrylic cover
<b>Indicators</b>	Red LED Alignment Indicator Device (AID) located on rear panel lights when the sensor sees a “light” condition; pulse rate is proportional to signal strength (the stronger the signal, the faster the pulse rate).
<b>Construction</b>	Reinforced thermoplastic polyester housing, totally encapsulated, o-ring sealing, acrylic lenses, and stainless steel screws
<b>Environmental Rating</b>	Meets NEMA standards 1, 2, 3, 3S, 4, 4X, 6, 12 and 13; IEC IP67
<b>Connections</b>	PVC-jacketed 2-conductor 2 m or 9 m cables, or special 4-pin Euro-style quick-disconnect (QD) fitting are available; QD cables are ordered separately. See page 381.
<b>Operating Conditions</b>	<b>Temperature:</b> -40° to +70° C <b>Relative humidity:</b> 90% at 50° C (non-condensing)
<b>Design Standards</b>	MIAD9 Series sensors comply with the following standards: DIN 19 234, EN 50 014 Part 1. 1977, EN50 020 Part 7. 1977, Factory Mutual #3610 and 3611, CSA 22.2 #157-92 and 22.2 #213-M1987
<b>Certifications</b>	    
<b>Hookup Diagrams</b>	SP02 (p. 489)

<b>APPROVALS</b>	
<b>CSA:</b> #LR 41887	Intrinsically Safe, with Entity for Class I, Groups A-D Class I, Div. 2, Groups A-D
<b>FM:</b> #J.I. 5Y3A4.AX	Intrinsically Safe, with Entity for Class I, II, III, Div. 1, Groups A-G Class I, II, III, Div. 2, Groups A-D and G
<b>KEMA:</b> #03ATEX1441X	II IG EEx ia IIC T6
<b>ETL:</b> #553868	

**Q23 Series**

Compact Sensors

# Q23 and QH23

## Vertical and Horizontal Rectangular Sensors

- Available with vertical and horizontal housings
- Delivers high power in a small package
- Features ranges up to 8 m
- Uses a powerful visible red sensing beam for easy setup and alignment
- Offered in opposed, polarized retroreflective, convergent, diffuse and plastic fiber optic modes
- Features marginal gain indicator with alarm output

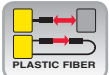
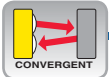
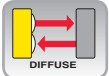
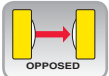

### Q23 and QH23 Sensors

- Dual-LED multi-function indicators
- Two housing styles
- 2 m or 9 m integral cable, or 150 mm Pico-style quick-disconnect pigtail

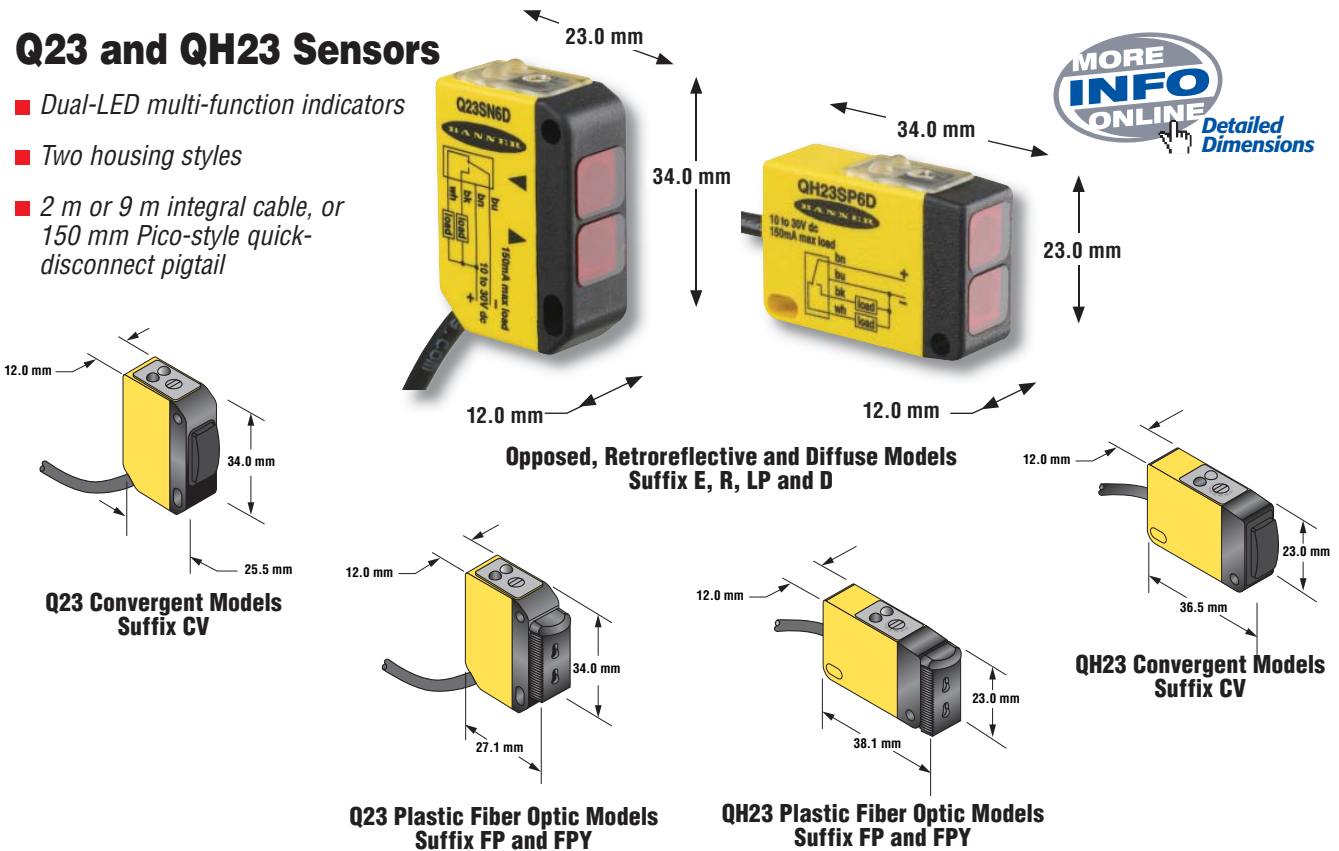





## Q23 and QH23, 10-30V dc

Models	Sensing Mode/LED*	Range	Cable**	Output Type	Excess Gain	Beam Pattern	Data Sheet
Q236E Emitter QH236E Emitter	<p>OPPOSED</p>	8 m	2 m	-	EGCO-15 (p. 428)	BPO-15 (p. 450)	46637
Q236EQ Emitter QH236EQ Emitter			4-pin Pico Pigtail QD				
Q23SN6R QH23SN6R			2 m	NPN			
Q23SN6RQ QH23SN6RQ			4-pin Pico Pigtail QD				
Q23SP6R QH23SP6R			2 m	PNP			
Q23SP6RQ QH23SP6RQ			4-pin Pico Pigtail QD				
Q23SN6LP QH23SN6LP	<p>POLAR RETRO</p>	100 mm - 2 m†	2 m	NPN	EGCR-20 (p. 432)	BPR-19 (p. 454)	46637
Q23SN6LPQ QH23SN6LPQ			4-pin Pico Pigtail QD				
Q23SP6LP QH23SP6LP			2 m	PNP			
Q23SP6LPQ QH23SP6LPQ			4-pin Pico Pigtail QD				
Q23SN6D QH23SN6D	<p>SHORT-RANGE DIFFUSE</p>	200 mm	2 m	NPN	EGCD-23 (p. 435)	BPD-22 (p. 457)	46637
Q23SN6DQ QH23SN6DQ			4-pin Pico Pigtail QD				
Q23SP6D QH23SP6D			2 m	PNP			
Q23SP6DQ QH23SP6DQ			4-pin Pico Pigtail QD				
Q23SN6DL QH23SN6DL	<p>LONG-RANGE DIFFUSE</p>	800 mm	2 m	NPN	EGCD-24 (p. 435)	BPD-23 (p. 457)	46637
Q23SN6DLQ QH23SN6DLQ			4-pin Pico Pigtail QD				
Q23SP6DL QH23SP6DL			2 m	PNP			
Q23SP6DLQ QH23SP6DLQ			4-pin Pico Pigtail QD				

\* Visible Red LED

\*\* For 9 m cable, add suffix **W/30** to the 2 m model number (example, **Q23SN6D W/30**). A model with a pigtail QD requires a mating cable (see page 378).

† Retroreflective range is specified using one model BRT-3 retroreflector. Actual sensing range may differ, depending on the efficiency and reflective area of the retroreflector used. See Accessories for more information.

**Q23 and QH23, 10-30V dc (cont'd)**



Models	Sensing Mode/LED*	Range	Cable**	Output Type	Excess Gain	Beam Pattern	Data Sheet
Q23SN6CV50 QH23SN6CV50	<p>CONVERGENT</p>	50 mm	2 m	NPN	EGCC-30 (p. 438)	BPC-30 (p. 460)	46637
Q23SN6CV50Q QH23SN6CV50Q			4-pin Pico Pigtail QD				
Q23SP6CV50 QH23SP6CV50			2 m	PNP			
Q23SP6CV50Q QH23SP6CV50Q			4-pin Pico Pigtail QD				
Q23SN6FP QH23SN6FP	<p>Standard Speed: 1 ms</p>	Range varies by sensing mode and fiber optics used	2 m	NPN	EGCP-14 & EGCP-15 (p. 447)	BPP-14 & BP-15 (p. 465)	46637
Q23SN6FPQ QH23SN6FPQ			4-pin Pico Pigtail QD				
Q23SP6FP QH23SP6FP			2 m	PNP			
Q23SP6FPQ QH23SP6FPQ			4-pin Pico Pigtail QD				
Q23SN6FPY QH23SN6FPY	<p>High Speed: 100 μs</p>		2 m	NPN	EGCP-16 (p. 447) & EGCP-17 (p. 448)	BPP-16 (p. 465) & BPP-17 (p. 466)	
Q23SN6FPYQ QH23SN6FPYQ			4-pin Pico Pigtail QD				
Q23SP6FPY QH23SP6FPY			2 m	PNP			
Q23SP6FPYQ QH23SP6FPYQ			4-pin Pico Pigtail QD				

\* Visible Red LED

\*\* For 9 m cable, add suffix **W/30** to the 2 m model number (example, **Q23SN6CV50 W/30**). A model with a pigtail QD requires a mating cable (see page 378).

**Q23 and QH23 Specifications**

<b>Supply Voltage and Current</b>	10 to 30V dc (10% max. ripple) at less than 25 mA for diffuse, Retroreflective, and fiber optic models (exclusive of load) Opposed emitters and receivers draw 20 mA each
<b>Supply Protection Circuitry</b>	Protected against reverse polarity and transient voltages
<b>Output Configuration</b>	Solid-state complementary (SPDT) dc switch; NPN (current sinking) or PNP (current sourcing), depending on model. The Dark Operate (DO) output may be wired as a normally open marginal signal alarm output, depending upon hookup to the power supply.
<b>Output Rating</b>	150 mA max. each in standard hookup; when wired for alarm output, the total load may not exceed 150 mA <b>Off-state leakage current:</b> less than 1 mA at 30V dc <b>Output saturation voltage:</b> less than 1 volt at 10 mA dc; less than 1.5V at 150 mA dc
<b>Output Protection Circuitry</b>	Protected against false pulse on power-up, transient voltages, and continuous overload or short-circuit of outputs
<b>Output Response Time</b>	<b>All other models:</b> 1 millisecond ON/OFF <b>Q23FPQ high-speed models:</b> 100 microsecond ON/OFF; protected against false pulse on power-up NOTE: 100 millisecond delay on power-up: outputs do not conduct during this time.

## Q23 and QH23 Specifications (cont'd)

<b>Repeatability</b>	<b>Opposed:</b> 0.13 milliseconds; <b>Retroreflective and Diffuse:</b> 0.25 milliseconds <b>FPY High-Speed Plastic Fiber Optic:</b> 25 microseconds Response time and repeatability specifications are independent of signal strength.
<b>Adjustments</b>	SENSITIVITY control (single-turn, o-ring sealed potentiometer)
<b>Indicators</b>	Sensors except opposed mode emitters have two LEDs: <b>Green ON steady:</b> dc power ON <b>Green flashing:</b> output overload <b>Yellow ON steady:</b> Light Operate (LO), output is energized <b>Yellow flashing:</b> marginal excess gain (1 - 1.5x), LO output is energized Emitters have green power "ON" indicator
<b>Construction</b>	Yellow and black ABS housing, with acrylic lenses, completely sealed. Stainless steel mounting bracket and M3 mounting hardware are supplied
<b>Environmental Rating</b>	Meets NEMA standards 1, 2, 3, 3S, 4, 4X, 6, 12, and 13; IEC IP67. Housing materials rated UL 94 V-0
<b>Connections</b>	PVC-jacketed 4-conductor 2 m or 9 m cables, or 4-pin Pico-style 50 mm threaded quick-disconnect (QD) fitting are available. Mating QD cables are ordered separately. See page 378.
<b>Operating Conditions</b>	<b>Temperature:</b> -20° to +55° C <b>Relative humidity:</b> 90% at 50° C (non-condensing)
<b>Application Notes</b>	To avoid damage to the sensor caused by static discharge (ESD), use the plastic screwdriver supplied with each sensor (included in the hardware packet) to adjust the SENSITIVITY control. Otherwise, use a screwdriver with an insulated handle.
<b>Certifications</b>	
<b>Hookup Diagrams</b>	<b>Emitters:</b> DC03 (p. 476) <b>NPN Models:</b> DC07 (p. 477) <b>PNP Models:</b> DC08 (p. 477)

# S18 and M18

## 18 mm Threaded-Barrel Sensors

- Features EZ-BEAM® technology, with specially designed optics and electronics for reliable sensing without adjustments
- Available in plastic threaded barrel sensor (S18) and stainless steel threaded barrel sensor (M18)
- Completely epoxy-encapsulated to provide superior durability, even in harsh sensing environments (S18)
- Uses innovative dual-indicator system to take the guesswork out of monitoring sensor performance
- Available in models for ac or dc power
- Includes advanced diagnostics to warn of marginal sensing conditions or output overload (dc models)
- Meets rigorous IP69K standards for use in 1200 psi washdowns (S18)

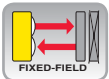
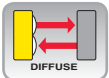
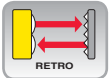
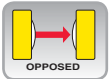

S18 DC Models.....Page 93

M18 DC Models.....94

S18 AC Models.....96

### S18 and M18 DC Sensors

- Advanced self-diagnostics with separate alarm output; dual-LED multi-function indicators
- Popular 18 mm threaded barrel
- 10 to 30V dc with NPN or PNP outputs
- 2 m or 9 m integral cable, or Euro-style quick-disconnect fitting



Detailed Dimensions

**S18 Opposed, Non-polarized Retroreflective and Diffuse Models Suffix E, R, L and D**

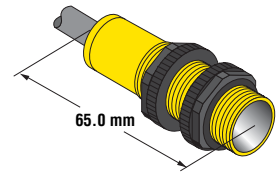

**S18 Polarized Retroreflective and Fixed-field Models Suffix LP and FF**



**M18 Opposed, Non-polarized Retroreflective and Diffuse Models Suffix E, R, L, D and DL**

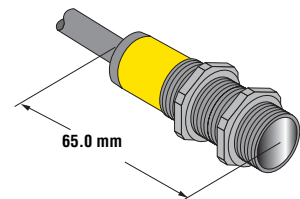

**M18 Polarized Retroreflective and Fixed-field Models Suffix LP and FF**





# S18, 10-30V dc

Models	Sensing Mode/LED*	Range	Cable**	Output Type	Excess Gain	Beam Pattern	Data Sheet
S186E Emitter S186EQ Emitter	 OPPOSED	20 m	2 m 4-Pin Euro QD	—	EGCO-16 (p. 428)	BPO-16 (p. 450)	116159
S18SN6R S18SN6RQ			2 m 4-Pin Euro QD	NPN			
S18SP6R S18SP6RQ			2 m 4-Pin Euro QD	PNP			
S18SN6L S18SN6LQ	 RETRO	2 m†	2 m 4-Pin Euro QD	NPN	EGCR-21 (p. 432)	BPR-20 (p. 454)	
S18SP6L S18SP6LQ			2 m 4-Pin Euro QD	PNP			
S18SN6LP S18SN6LPQ	 POLAR RETRO	2 m†	2 m 4-Pin Euro QD	NPN	EGCR-22 (p. 432)	BPR-21 (p. 454)	
S18SP6LP S18SP6LPQ			2 m 4-Pin Euro QD	PNP			
S18SN6FF25 S18SN6FF25Q	 FIXED-FIELD	0 - 25 mm Cutoff	2 m 4-Pin Euro QD	NPN	EGCF-6 (p. 441)	—	
S18SP6FF25 S18SP6FF25Q			2 m 4-Pin Euro QD	PNP			
S18SN6FF50 S18SN6FF50Q		0 - 50 mm Cutoff	2 m 4-Pin Euro QD	NPN	EGCF-7 (p. 441)	—	
S18SP6FF50 S18SP6FF50Q			2 m 4-Pin Euro QD	PNP			
S18SN6FF100 S18SN6FF100Q		0 - 100 mm Cutoff	2 m 4-Pin Euro QD	NPN	EGCF-8 (p. 441)	—	
S18SP6FF100 S18SP6FF100Q			2 m 4-Pin Euro QD	PNP			
S18SN6D S18SN6DQ		 DIFFUSE	100 mm	2 m 4-Pin Euro QD	NPN	EGCD-25 (p. 435)	BPD-24 (p. 457)
S18SP6D S18SP6DQ				2 m 4-Pin Euro QD	PNP		
S18SN6DL S18SN6DLQ	300 mm		2 m 4-Pin Euro QD	NPN	EGCD-26 (p. 435)	BPD-25 (p. 457)	
S18SP6DL S18SP6DLQ			2 m 4-Pin Euro QD	PNP			

\* Infrared LED    Visible Red LED

\*\* For 9 m cable, add suffix **W/30** to the 2 m model number (example, **S18SP6D W/30**). A model with a QD requires a mating cable (see page 380).

† Retroreflective range is specified using one model BRT-3 retroreflector. Actual sensing range may differ, depending on the efficiency and reflective area of the retroreflector used. See Accessories for more information.

**M18, 10-30V dc**





Models	Sensing Mode/LED*	Range	Cable**	Output Type	Excess Gain	Beam Pattern	Data Sheet
M186E Emitter M186EQ Emitter		20 m	2 m 4-Pin Euro QD	-	EGCO-17 (p. 429)	BPO-17 (p.451)	49201
M18SN6R M18SN6RQ			2 m 4-Pin Euro QD	NPN			
M18SP6R M18SP6RQ			2 m 4-Pin Euro QD	PNP			
M18SN6L M18SN6LQ		2 m†	2 m 4-Pin Euro QD	NPN	EGCR-23 (p. 432)	BPR-22 (p. 454)	
M18SP6L M18SP6LQ			2 m 4-Pin Euro QD	PNP			
M18SN6LP M18SN6LPQ		2 m†	2 m 4-Pin Euro QD	NPN	EGCR-24 (p. 432)	BPR-23 (p. 454)	
M18SP6LP M18SP6LPQ			2 m 4-Pin Euro QD	PNP			
M18SN6FF25 M18SN6FF25Q		0 - 25 mm Cutoff	2 m 4-Pin Euro QD	NPN	EGCF-9 (p. 441)	—	
M18SP6FF25 M18SP6FF25Q			2 m 4-Pin Euro QD	PNP			
M18SN6FF50 M18SN6FF50Q		0 - 50 mm Cutoff	2 m 4-Pin Euro QD	NPN	EGCF-10 (p. 441)	—	
M18SP6FF50 M18SP6FF50Q			2 m 4-Pin Euro QD	PNP			
M18SN6FF100 M18SN6FF100Q		0 - 100 mm Cutoff	2 m 4-Pin Euro QD	NPN	EGCF-11 (p. 441)	—	
M18SP6FF100 M18SP6FF100Q			2 m 4-Pin Euro QD	PNP			
M18SN6D M18SN6DQ			100 mm	2 m 4-Pin Euro QD	NPN	EGCD-27 (p. 435)	BPD-26 (p. 457)
M18SP6D M18SP6DQ	2 m 4-Pin Euro QD			PNP			
M18SN6DL M18SN6DLQ	300 mm		2 m 4-Pin Euro QD	NPN	EGCD-28 (p. 435)	BPD-27 (p. 457)	
M18SP6DL M18SP6DLQ			2 m 4-Pin Euro QD	PNP			

\* Infrared LED    Visible Red LED

\*\* For 9 m cable, add suffix **W/30** to the 2 m model number (example, **M18SN6D W/30**). A model with a QD requires a mating cable (see page 380).

† Retroreflective range is specified using one model BRT-3 retroreflector. Actual sensing range may differ, depending on the efficiency and reflective area of the retroreflector used. See Accessories for more information.

## S18 and M18 DC Specifications

<b>Supply Voltage and Current</b>	10 to 30V dc (10% max. ripple); Supply current (exclusive of load current): <b>Opposed Mode Emitters:</b> 25 mA <b>Opposed Mode Receivers:</b> 20 mA <b>Polarized Retroreflective:</b> 30 mA <b>Non-polarized Retroreflective:</b> 25 mA <b>Fixed-field:</b> 35 mA <b>Diffuse:</b> 25 mA
<b>Supply Protection Circuitry</b>	Protected against reverse polarity and transient voltages
<b>Output Configuration</b>	Solid-state complementary (SPDT) dc switch; NPN (current sinking) or PNP (current sourcing), depending on model. The Dark Operate (DO) output may be wired as a normally open marginal signal alarm output, depending upon hookup to the power supply.
<b>Output Rating</b>	150 mA max. (each) in standard hookup. When wired for alarm output, the total load may not exceed 150 mA <b>Off-state leakage current:</b> less than 1 mA at 30V dc; <b>On-state saturation voltage:</b> less than 1V at 10 mA dc; <1.5V at 150 mA dc
<b>Output Protection Circuitry</b>	Protected against false pulse on power-up and continuous overload or short circuit of outputs
<b>Output Response Time</b>	<b>Opposed:</b> 3 milliseconds ON, 1.5 milliseconds OFF; <b>Polarized Retroreflective, Non-polarized Retroreflective, Fixed-field and Diffuse:</b> 3 milliseconds ON/OFF NOTE: 100 millisecond delay on power-up; outputs are non-conducting during this time
<b>Repeatability</b>	<b>Opposed:</b> 375 microseconds; <b>Polarized Retroreflective, Non-polarized Retroreflective, Fixed-field and Diffuse:</b> 750 microseconds. Repeatability and response are independent of signal strength.
<b>Indicators</b>	<b>Two LEDs:</b> Green and Yellow <b>Green ON steady:</b> power to sensor is ON <b>Green flashing:</b> output is overloaded (dc models only) <b>Yellow ON steady:</b> Light Operate (LO) output is energized <b>Yellow flashing:</b> excess gain marginal (1-1.5x) in light condition, LO output is energized
<b>Construction</b>	<b>M18 models:</b> stainless steel housing <b>S18 models:</b> thermoplastic polyester housing Lenses are polycarbonate or acrylic; S18 and M18 models come with two jam nuts.
<b>Environmental Rating</b>	Leakproof design rated NEMA 6P, DIN 40050 (IP69K)
<b>Connections</b>	2 m or 9 m attached cable, or 4-pin Euro-style quick-disconnect fitting. QD cables are ordered separately. See page 380.
<b>Operating Conditions</b>	<b>Temperature:</b> -40° to +70° C <b>Relative humidity:</b> 90% at 50° C (non-condensing)
<b>Vibration and Mechanical Shock</b>	All models meet Mil. Std. 202F requirements. Method 201A (Vibration; frequency 10 to 60 Hz, max., double amplitude 0.06-inch acceleration 10G). Method 213B conditions H&I (Shock: 75G with unit operating; 100G for non-operation)
<b>Certifications (S18 models)</b>	   Excludes M18
<b>Hookup Diagrams</b>	<b>Emitters:</b> DC03 (p. 476) <b>NPN Models:</b> DC07 (p. 477) <b>PNP Models:</b> DC08 (p. 477)

## S18/M18 Series

### Compact Sensors

## S18 AC Sensors

- 18 mm thermoplastic polyester threaded barrel sensor
- Dual LED indicators
- 20 to 250V ac (3-wire hookup)
- SPST solid-state switch output, maximum load 300 mA

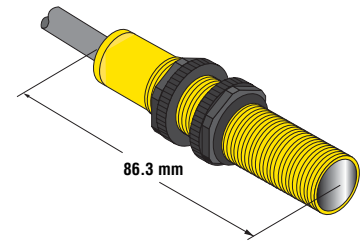

**S18 Polarized Retroreflective and Fixed-field models  
Suffix LP and FF**

**S18 Opposed, Non-polarized  
Retroreflective and Diffuse models  
Suffix E, R, L and D**



## S18, 20-250V ac

Models	Sensing Mode/LED*	Range	Cable**	Output Type	Excess Gain	Beam Pattern	Data Sheet
S183E Emitter S183EQ1 Emitter		20 m	2 m 4-Pin Micro QD	—	EGCO-16 (p. 428)	BPO-16 (p. 450)	116160
S18AW3R S18AW3RQ1			2 m 4-Pin Micro QD	LO			
S18RW3R S18RW3RQ1			2 m 4-Pin Micro QD	DO			
S18AW3L S18AW3LQ1		2 m†	2 m 4-Pin Micro QD	LO	EGCR-21 (p. 432)	BPR-20 (p. 454)	
S18RW3L S18RW3LQ1			2 m 4-Pin Micro QD	DO			
S18AW3LP S18AW3LPQ1		2 m†	2 m 4-Pin Micro QD	LO	EGCR-22 (p. 432)	BPR-21 (p. 454)	
S18RW3LP S18RW3LPQ1			2 m 4-Pin Micro QD	DO			
S18AW3FF25 S18AW3FF25Q1		0 - 25 mm Cutoff	2 m 4-Pin Micro QD	LO	EGCF-6 (p. 441)	—	
S18RW3FF25 S18RW3FF25Q1			2 m 4-Pin Micro QD	DO			
S18AW3FF50 S18AW3FF50Q1		0 - 50 mm Cutoff	2 m 4-Pin Micro QD	LO	EGCF-7 (p. 441)	—	
S18RW3FF50 S18RW3FF50Q1			2 m 4-Pin Micro QD	DO			
S18AW3FF100 S18AW3FF100Q1		0 - 100 mm Cutoff	2 m 4-Pin Micro QD	LO	EGCF-8 (p. 441)	—	
S18RW3FF100 S18RW3FF100Q1			2 m 4-Pin Micro QD	DO			

\* Infrared LED Visible Red LED

\*\* For 9 m cable, add suffix **W/30** to the 2 m model number (example, **S18AW3LP W/30**). A model with a QD requires a mating cable (see page 386).

† Retroreflective range is specified using one model BRT-3 retroreflector. Actual sensing range may differ, depending on the efficiency and reflective area of the retroreflector used. See Accessories for more information.



## S18, 20-250V ac (cont'd)

Models	Sensing Mode/LED*	Range	Cable**	Output Type	Excess Gain	Beam Pattern	Data Sheet
S18AW3D S18AW3DQ1		100 mm	2 m 4-Pin Micro QD	LO	EGCD-25 (p. 435)	BPD-24 (p. 457)	116160
S18RW3D S18RW3DQ1			2 m 4-Pin Micro QD	DO			
S18AW3DL S18AW3DLQ1		300 mm	2 m 4-Pin Micro QD	LO	EGCD-26 (p. 435)	BPD-25 (p. 457)	
S18RW3DL S18RW3DLQ1			2 m 4-Pin Micro QD	DO			

\* Infrared LED

\*\* For 9 m cable, add suffix **W/30** to the 2 m model number (example, **S18AW3D W/30**). A model with a QD requires a mating cable (see page 386).

## S18 AC Specifications

<b>Supply Voltage and Current</b>	20 to 250V ac (50/60 Hz). Average current 20 mA. Peak current: 200 mA at 20V ac, 500 mA at 120V ac, 750 mA at 250V ac
<b>Supply Protection Circuitry</b>	Protected against transient voltages
<b>Output Configuration</b>	SPST solid-state ac switch; three-wire hookup; Light Operate (LO) or Dark Operate (DO), depending on model. <b>Light operate:</b> Output conducts when the sensor sees its own (or the emitter's) modulated light <b>Dark operate:</b> Output conducts when sensor sees dark
<b>Output Rating</b>	300 mA max. (continuous) <b>Fixed-field models:</b> derate 5 mA/° C above +50° C; <b>Inrush capability:</b> 1 amp for 20 milliseconds, non-repetitive <b>Off-state leakage current:</b> less than 100 mA <b>On-state voltage drop:</b> 3V at 300 mA ac; 2V at 15 mA ac
<b>Output Protection Circuitry</b>	Protected against false pulse on power-up
<b>Output Response Time</b>	<b>Opposed Mode:</b> 16 milliseconds ON, 8 milliseconds OFF; <b>Polarized Retroreflective, Non-polarized Retroreflective, Fixed-field, and Diffuse:</b> 16 milliseconds ON/OFF NOTE: 100 millisecond delay on power-up
<b>Repeatability</b>	<b>Opposed Mode:</b> 2 milliseconds; <b>Polarized Retroreflective, Non-polarized Retroreflective, Fixed-field, and Diffuse:</b> 4 milliseconds. Repeatability and response are independent of signal strength.
<b>Indicators</b>	<b>Two LEDs:</b> Green and Yellow <b>Green ON steady:</b> power to sensor is ON <b>Yellow ON steady:</b> sensor sees light <b>Yellow flashing:</b> excess gain marginal (1-1.5x) in light condition
<b>Construction</b>	Housings are thermoplastic polyester. Lenses are polycarbonate or acrylic; two jam nuts included.
<b>Environmental Rating</b>	<b>S18 models:</b> Leakproof design rated NEMA 6P, DIN 40050 (IP69K) <b>M18 models:</b> Rated NEMA 6P (IP67)
<b>Connections</b>	2 m or 9 m attached cable, or 4 pin Micro-style quick-disconnect fitting. QD cables are ordered separately. See page 386.
<b>Operating Conditions</b>	<b>Temperature:</b> -40° to +70° C <b>Relative humidity:</b> 90% at 50° C (non-condensing)
<b>Vibration and Mechanical Shock</b>	All models meet Mil. Std. 202F requirements. Method 201A (Vibration; frequency 10 to 60 Hz, max, double amplitude 0.06-inch acceleration 10G). Method 213B conditions H&I (Shock: 75G with unit operating; 100G for non-operation)
<b>Certifications</b>	S18 & M18 models                      S18 models only                      S18 models only
<b>Hookup Diagrams</b>	<b>Cabled Emitters:</b> AC03 (p. 484) <b>Other Cabled Models:</b> AC05 (p. 485) <b>QD Emitters:</b> AC07 (p. 485) <b>Other QD Models:</b> AC06 (p. 485)



# T18

## 18 mm Threaded Right-Angle Sensors

- Features EZ-BEAM® technology, with specially designed optics and electronics for reliable sensing without adjustments on most models
- T-style plastic housing with 18 mm threaded lens mount
- Available in opposed, retroreflective, diffuse and fixed-field modes
- Completely epoxy-encapsulated to provide superior durability, even in harsh sensing environments
- Uses innovative dual-indicator system to take the guesswork out of monitoring sensor performance
- Includes advanced diagnostics to warn of marginal sensing conditions or output overload (dc models)

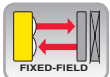
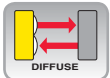
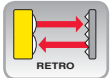
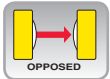

DC Models .....Page 99  
AC Models ..... 101

### T18 DC Sensors

- Dual-LED multi-function indicators
- Popular 18 mm threaded lens mount
- 10 to 30V dc with NPN or PNP outputs
- 2 m or 9 m attached cable, or Euro-style quick-disconnect



T18 DC Sensors (all models)



# T18, 10-30V dc

Models	Sensing Mode/LED*	Range	Cable**	Output Type	Excess Gain	Beam Pattern	Data Sheet
T186E Emitter T186EQ Emitter		20 m	2 m 4-Pin Euro QD	-	EGCO-18 (p. 429)	BPO-18 (p. 451)	116163
T18SN6R T18SN6RQ			2 m 4-Pin Euro QD	NPN			
T18SP6R T18SP6RQ			2 m 4-Pin Euro QD	PNP			
T18SN6L T18SN6LQ		2 m†	2 m 4-Pin Euro QD	NPN	EGCR-25 (p. 432)	BPR-24 (p. 454)	
T18SP6L T18SP6LQ			2 m 4-Pin Euro QD	PNP			
T18SN6LP T18SN6LPQ		2 m†	2 m 4-Pin Euro QD	NPN	EGCR-26 (p. 432)	BPR-25 (p. 454)	
T18SP6LP T18SP6LPQ			2 m 4-Pin Euro QD	PNP			
T18SN6FF25 T18SN6FF25Q		0 - 25 mm Cutoff	2 m 4-Pin Euro QD	NPN	EGCF-12 (p. 441)	—	
T18SP6FF25 T18SP6FF25Q			2 m 4-Pin Euro QD	PNP			
T18SN6FF50 T18SN6FF50Q		0 - 50 mm Cutoff	2 m 4-Pin Euro QD	NPN	EGCF-13 (p. 441)	—	
T18SP6FF50 T18SP6FF50Q			2 m 4-Pin Euro QD	PNP			
T18SN6FF100 T18SN6FF100Q		0 - 100 mm Cutoff	2 m 4-Pin Euro QD	NPN	EGCF-14 (p. 441)	—	
T18SP6FF100 T18SP6FF100Q			2 m 4-Pin Euro QD	PNP			
T18SN6D T18SN6DQ		500 mm	2 m 4-Pin Euro QD	NPN	EGCD-29 (p. 435)	BPD-28 (p. 457)	
T18SP6D T18SP6DQ			2 m 4-Pin Euro QD	PNP			

\* Infrared LED      Visible Red LED

\*\* For 9 m cable, add suffix **W/30** to the 2 m model number (example, **T18SN6L W/30**). A model with a QD requires a mating cable (see page 380).

† Retroreflective range is specified using one model BRT-3 retroreflector. Actual sensing range may differ, depending on the efficiency and reflective area of the retroreflector used. See Accessories for more information.

## T18 DC Specifications

<b>Supply Voltage and Current</b>	10 to 30V dc (10% max. ripple); Supply current (exclusive of load current): <b>Opposed Mode Emitters:</b> 25 mA <b>Opposed Mode Receivers:</b> 20 mA <b>Polarized Retroreflective:</b> 30 mA <b>Non-polarized Retroreflective:</b> 25 mA <b>Diffuse:</b> 25 mA <b>Fixed-field:</b> 35 mA
<b>Supply Protection Circuitry</b>	Protected against reverse polarity and transient voltages
<b>Output Configuration</b>	Solid-state complementary (SPDT) dc switch; NPN (current sinking) or PNP (current sourcing), depending on model. The Dark Operate (DO) output may be wired as a normally open marginal signal alarm output, depending upon hookup to the power supply.
<b>Output Rating</b>	150 mA max. (each) in standard hookup. When wired for alarm output, the total load may not exceed 150 mA; <b>Off-state leakage current:</b> less than 1 mA at 30V dc; <b>On-state saturation voltage:</b> less than 1V at 10 mA dc; <1.5V at 150 mA dc
<b>Output Protection Circuitry</b>	Protected against false pulse on power-up and continuous overload or short circuit of outputs
<b>Output Response Time</b>	<b>Opposed:</b> 3 milliseconds ON, 1.5 milliseconds OFF; <b>Polarized Retroreflective, Non-polarized Retroreflective, Fixed-field and Diffuse:</b> 3 milliseconds ON/OFF NOTE: 100 millisecond delay on power-up; outputs are non-conducting during this time
<b>Adjustments</b>	T18 Series infrared non-polarized retroreflective and diffuse mode models (only) have a single-turn rear-panel SENSITIVITY control for adjustment of system gain (turn clockwise to increase)
<b>Repeatability</b>	<b>Opposed:</b> 375 microseconds; <b>Polarized Retroreflective, Non-polarized Retroreflective, Fixed-field and Diffuse:</b> 750 microseconds. Repeatability and response are independent of signal strength.
<b>Indicators</b>	<b>Two LEDs:</b> Green and Yellow <b>Green ON steady:</b> power to sensor is ON <b>Green flashing:</b> output is overloaded (dc models only) <b>Yellow ON steady:</b> Light Operate (LO) output is energized <b>Yellow flashing:</b> excess gain marginal (1-1.5x) in light condition, LO output is energized
<b>Construction</b>	Housings are thermoplastic polyester. Lenses are polycarbonate or acrylic; one jam nut included
<b>Environmental Rating</b>	Leakproof design rated NEMA 6P, DIN 40050 (IP69K)
<b>Connections</b>	2 m or 9 m attached cable, or 4-pin Euro-style quick-disconnect fitting. QD cables are ordered separately. See page 380.
<b>Operating Conditions</b>	<b>Temperature:</b> -40° to +70° C <b>Relative humidity:</b> 90% at 50° C (non-condensing)
<b>Vibration and Mechanical Shock</b>	All models meet Mil. Std. 202F requirements. Method 201A (Vibration; frequency 10 to 60 Hz, max., double amplitude 0.06-inch acceleration 10G). Method 213B conditions H&I (Shock: 75G with unit operating; 100G for non-operation)
<b>Certifications</b>	
<b>Hookup Diagrams</b>	<b>Emitters:</b> DC03 (p. 476) <b>NPN Models:</b> DC07 (p. 477) <b>PNP Models:</b> DC08 (p. 477)

# T18 AC Sensors

- Dual-LED multi-function indicators
- Popular 18 mm threaded barrel
- 20 to 250V ac with solid-state outputs
- 2 m or 9 m attached cable, or Euro-style quick-disconnect



T18 AC Sensors (all models)

## T18, 20-250V ac



Models	Sensing Mode/LED*	Range	Cable**	Output Type	Excess Gain	Beam Pattern	Data Sheet
T183E Emitter T183EQ1 Emitter	 OPPOSED	20 m	2 m 4-Pin Micro QD	-	EGCO-18 (p. 429)	BPO-18 (p. 451)	116164
T18AW3R T18AW3RQ1			2 m 4-Pin Micro QD	LO			
T18RW3R T18RW3RQ1			2 m 4-Pin Micro QD	DO			
T18AW3L T18AW3LQ1	 RETRO	2 m†	2 m 4-Pin Micro QD	LO	EGCR-25 (p. 432)	BPR-24 (p. 454)	
T18RW3L T18RW3LQ1			2 m 4-Pin Micro QD	DO			
T18AW3LP T18AW3LPQ1	 POLAR RETRO	2 m†	2 m 4-Pin Micro QD	LO	EGCR-26 (p. 432)	BPR-25 (p. 454)	
T18RW3LP T18RW3LPQ1			2 m 4-Pin Micro QD	DO			
T18AW3D T18AW3DQ1	 DIFFUSE	300 mm	2 m 4-Pin Micro QD	LO	EGCD-30 (p. 435)	BPD-29 (p. 457)	
T18RW3D T18RW3DQ1			2 m 4-Pin Micro QD	DO			

\* Infrared LED    Visible Red LED

\*\* For 9 m cable, add suffix **W/30** to the 2 m model number (example, **T18AW3L W/30**). A model with a QD requires a mating cable (see page 386).

† Retroreflective range is specified using one model BRT-3 retroreflector. Actual sensing range may differ, depending on the efficiency and reflective area of the retroreflector used. See Accessories for more information.

# T18 Series

Compact Sensors

PHOTOELECTRICS

## T18, 20-250V ac (cont'd)



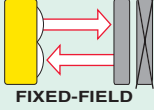

Models	Sensing Mode/LED*	Range	Cable**	Output Type	Excess Gain	Beam Pattern	Data Sheet
T18AW3FF25 T18AW3FF25Q1		0 - 25 mm Cutoff	2 m	LO	EGCF-12 (p. 441)	—	32994
T18RW3FF25 T18RW3FF25Q1			4-Pin Micro QD	DO			
T18AW3FF50 T18AW3FF50Q1		0 - 50 mm Cutoff	2 m	LO	EGCF-13 (p. 441)	—	
T18RW3FF50 T18RW3FF50Q1			4-Pin Micro QD	DO			
T18AW3FF100 T18AW3FF100Q1		0 - 100 mm Cutoff	2 m	LO	EGCF-14 (p. 441)	—	
T18RW3FF100 T18RW3FF100Q1			4-Pin Micro QD	DO			

\*  Infrared LED

\*\* For 9 m cable, add suffix **W/30** to the 2 m model number (example, **T18AW3FF25 W/30**). A model with a QD requires a mating cable (see page 386).

## T18 AC Specifications

<b>Supply Voltage and Current</b>	20 to 250V ac (50/60 Hz). Average current 20 mA. Peak current: 200 mA at 20V ac, 500 mA at 120V ac, 750 mA at 250V ac
<b>Supply Protection Circuitry</b>	Protected against transient voltages
<b>Output Configuration</b>	SPST solid-state ac switch; three-wire hookup; Light Operate (LO) or Dark Operate (DO), depending on model. <b>Light operate:</b> Output conducts when the sensor sees its own (or the emitter's) modulated light <b>Dark operate:</b> Output conducts when sensor sees dark
<b>Output Rating</b>	300 mA max. (continuous) <b>Fixed-field models:</b> derate 5 mA/° C above +50° C; <b>Inrush capability:</b> 1 amp for 20 milliseconds, non-repetitive <b>Off-state leakage current:</b> less than 100 mA <b>On-state voltage drop:</b> 3V at 300 mA ac; 2V at 15 mA ac
<b>Output Protection Circuitry</b>	Protected against false pulse on power-up
<b>Output Response Time</b>	<b>Opposed Mode:</b> 16 milliseconds ON, 8 milliseconds OFF <b>Polarized Retroreflective, Non-polarized Retroreflective, Fixed-field &amp; Diffuse:</b> 16 milliseconds ON/OFF NOTE: 100 millisecond delay on power-up
<b>Repeatability</b>	<b>Opposed Mode:</b> 2 ms; <b>Polarized Retroreflective, Non-polarized Retroreflective, Fixed-field, and Diffuse:</b> 4 milliseconds Repeatability and response are independent of signal strength.
<b>Adjustments</b>	T18 Series infrared non-polarized retroreflective and diffuse mode models (only) have a single-turn rear-panel SENSITIVITY control for adjustment of system gain (turn clockwise to increase)
<b>Indicators</b>	<b>Two LEDs:</b> Green and Yellow <b>Green ON steady:</b> power to sensor is ON <b>Yellow ON steady:</b> sensor sees light <b>Yellow flashing:</b> excess gain marginal (1-1.5x) in light condition
<b>Construction</b>	Housings are thermoplastic polyester. Lenses are polycarbonate or acrylic; T18 models come with one jam nut.
<b>Environmental Rating</b>	Leakproof design rated NEMA 6P, DIN 40050 (IP69K)
<b>Connections</b>	2 m or 9 m attached cable, or 4 pin Micro-style quick-disconnect fitting. QD cables are ordered separately. See page 386.
<b>Operating Conditions</b>	<b>Temperature:</b> -40° to +70° C <b>Relative humidity:</b> 90% at 50° C (non-condensing)
<b>Vibration and Mechanical Shock</b>	All models meet Mil. Std. 202F requirements. Method 201A (Vibration; frequency 10 to 60 Hz, max, double amplitude 0.06-inch acceleration 10G). Method 213B conditions H&I (Shock: 75G with unit operating; 100G for non-operation)
<b>Certifications</b>	  
<b>Hookup Diagrams</b>	<b>Cabled Emitters:</b> AC03 (p. 484) <b>Other cabled Models:</b> AC05 (p. 485) <b>QD Emitters:</b> AC07 (p. 485) <b>Other QD Models:</b> AC06 (p. 485)





# Q25

## Right-Angle Rectangular Sensors

- Features EZ-BEAM® technology, with specially designed optics and electronics for reliable sensing without adjustments
- Available in opposed, retroreflective or fixed-field modes in rectangular 25 mm plastic housing with 18 mm threaded mounting base
- Completely epoxy-encapsulated for superior durability, even in harsh sensing environments
- Uses an innovative dual-indicator system to take the guesswork out of monitoring sensor performance
- Available in models for ac or dc power
- Includes advanced diagnostics to warn of marginal sensing conditions or output overload (dc models)

### Q25 Sensors

- Yellow LED output indicator
- 18 mm threaded mounting base
- 2 m or 9 m attached cable, or Euro-style quick disconnect
- Green LED power indicator



Q25 Opposed and Retroreflective models  
Suffix E, R and LP



Detailed Dimensions

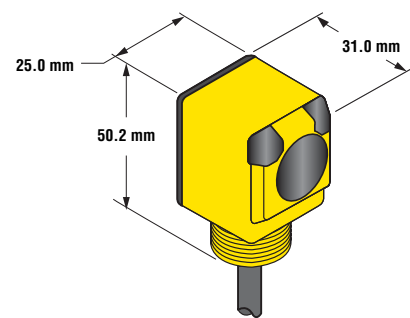

Q25 Fixed-field models  
Suffix FF

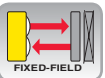
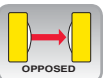

## Q25 Series

Compact Sensors

### Q25, 10-30V dc



Models	Sensing Mode/LED*	Range	Cable**	Output Type	Excess Gain	Beam Pattern	Data Sheet
Q256E Emitter Q256EQ Emitter	 OPPOSED	20 m	2 m 4-Pin Euro QD	-	EGCO-19 (p. 429)	BPO-19 (p. 451)	116165
Q25SN6R Q25SN6RQ			2 m 4-Pin Euro QD	NPN			
Q25SP6R Q25SP6RQ			2 m 4-Pin Euro QD	PNP			
Q25SN6LP Q25SN6LPQ	 POLAR RETRO	2 m†	2 m 4-Pin Euro QD	NPN	EGCR-27 (p. 432)	BPR-26 (p. 454)	
Q25SP6LP Q25SP6LPQ			2 m 4-Pin Euro QD	PNP			
Q25SN6FF25 Q25SN6FF25Q			0 - 25 mm Cutoff	2 m 4-Pin Euro QD			
Q25SP6FF25 Q25SP6FF25Q	2 m 4-Pin Euro QD	PNP					
Q25SN6FF50 Q25SN6FF50Q	0 - 50 mm Cutoff	2 m 4-Pin Euro QD		NPN	EGCF-16 (p. 441)	—	
Q25SP6FF50 Q25SP6FF50Q		2 m 4-Pin Euro QD	PNP				
Q25SN6FF100 Q25SN6FF100Q		0 - 100 mm Cutoff	2 m 4-Pin Euro QD	NPN			
Q25SP6FF100 Q25SP6FF100Q	2 m 4-Pin Euro QD		PNP				

### Q25, 20-250V ac





Models	Sensing Mode/LED*	Range	Cable**	Output Type	Excess Gain	Beam Pattern	Data Sheet
Q253E Emitter Q253EQ1 Emitter	 OPPOSED	20 m	2 m 4-Pin Micro QD	-	EGCO-19 (p. 429)	BPO-19 (p. 451)	116166
Q25AW3R Q25AW3RQ1			2 m 4-Pin Micro QD	LO			
Q25RW3R Q25RW3RQ1			2 m 4-Pin Micro QD	DO			
Q25AW3LP Q25AW3LPQ1	 POLAR RETRO	2 m†	2 m 4-Pin Micro QD	LO	EGCR-27 (p. 432)	BPR-26 (p. 454)	
Q25RW3LP Q25RW3LPQ1			2 m 4-Pin Micro QD	DO			
Q25AW3FF25 Q25AW3FF25Q1			0 - 25 mm Cutoff	2 m 4-Pin Micro QD			
Q25RW3FF25 Q25RW3FF25Q1	2 m 4-Pin Micro QD	DO					
Q25AW3FF50 Q25AW3FF50Q1	0 - 50 mm Cutoff	2 m 4-Pin Micro QD		LO	EGCF-16 (p. 441)	—	
Q25RW3FF50 Q25RW3FF50Q1		2 m 4-Pin Micro QD	DO				
Q25AW3FF100 Q25AW3FF100Q1		0 - 100 mm Cutoff	2 m 4-Pin Micro QD	LO			
Q25RW3FF100 Q25RW3FF100Q1	2 m 4-Pin Micro QD		DO				

\* Infrared LED    Visible Red LED

\*\* For 9 m cable, add suffix **W/30** to the 2 m model number (example, **Q25AW3LP W/30**). A model with a QD requires a mating cable (see pages 380 and 386).

† Retroreflective range is specified using one model BRT-3 retroreflector. Actual sensing range may differ, depending on the efficiency and reflective area of the retroreflector used. See Accessories for more information.

## Q25 DC Specifications

<b>Supply Voltage and Current</b>	10 to 30V dc (10% max. ripple); Supply current (exclusive of load current): <b>Opposed Mode Emitters:</b> 25 mA <b>Opposed Mode Receivers:</b> 20 mA <b>Polarized Retroreflective:</b> 30 mA <b>Fixed-field:</b> 35 mA
<b>Supply Protection Circuitry</b>	Protected against reverse polarity and transient voltages
<b>Output Configuration</b>	Solid-state complementary (SPDT) dc switch; NPN (current sinking) or PNP (current sourcing), depending on model. The Dark Operate (DO) output may be wired as a normally open marginal signal alarm output, depending upon hookup to the power supply.
<b>Output Rating</b>	150 mA max. (each) in standard hookup. When wired for alarm output, the total load may not exceed 150 mA <b>Off-state leakage current:</b> less than 1 mA at 30V dc <b>On-state saturation voltage:</b> less than 1V at 10 mA dc; <1.5V at 150 mA dc
<b>Output Protection Circuitry</b>	Protected against false pulse on power-up and continuous overload or short circuit of outputs
<b>Output Response Time</b>	<b>Opposed:</b> 3 milliseconds ON, 1.5 milliseconds OFF; <b>Polarized Retroreflective and Fixed-field:</b> 3 milliseconds ON/OFF NOTE: 100 millisecond delay on power-up; outputs do not conduct during this time
<b>Repeatability</b>	<b>Opposed:</b> 375 microseconds; <b>Polarized Retroreflective and Fixed-field:</b> 750 microseconds. Repeatability and response are independent of signal strength.
<b>Indicators</b>	<b>Two LEDs:</b> Green and Yellow <b>Green ON steady:</b> power to sensor is ON <b>Green flashing:</b> output is overloaded (dc models only) <b>Yellow ON steady:</b> Light Operate (LO) output is energized <b>Yellow flashing:</b> excess gain marginal (1-1.5x) in light condition, LO output is energized
<b>Construction</b>	Housings are thermoplastic polyester. Lenses are polycarbonate or acrylic; come with one jam nut.
<b>Environmental Rating</b>	Leakproof design rated NEMA 6P, DIN 40050 (IP69K)
<b>Connections</b>	2 m or 9 m attached cable, or 4-pin Euro-style quick-disconnect fitting. QD cables are ordered separately. See page 380.
<b>Operating Conditions</b>	<b>Temperature:</b> -40° to +70° C <b>Relative humidity:</b> 90% at 50° C (non-condensing)
<b>Vibration and Mechanical Shock</b>	All models meet Mil. Std. 202F requirements. Method 201A (Vibration; frequency 10 to 60 Hz, max., double amplitude 0.06-inch acceleration 10G). Method 213B conditions H&I (Shock: 75G with unit operating; 100G for non-operation)
<b>Certifications</b>	  
<b>Hookup Diagrams</b>	<b>Emitters:</b> DC03 (p. 476) <b>NPN Models:</b> DC07 (p. 477) <b>PNP Models:</b> DC08 (p. 477)

## Q25 AC Specifications

<b>Supply Voltage and Current</b>	20 to 250V ac (50/60 Hz). Average current 20 mA. Peak current: 200 mA at 20V ac, 500 mA at 120V ac, 750 mA at 250V ac	
<b>Supply Protection Circuitry</b>	Protected against transient voltages	
<b>Output Configuration</b>	SPST solid-state ac switch; three-wire hookup; Choose Light Operate (LO) or Dark Operate (DO), depending on model. <b>Light operate:</b> Output conducts when the sensor sees its own (or the emitter's) modulated light <b>Dark operate:</b> Output conducts when sensor sees dark	
<b>Output Rating</b>	300 mA max. (continuous) <b>Fixed-field models:</b> derate 5 mA/° C above +50° C; <b>Inrush capability:</b> 1 amp for 20 milliseconds, non-repetitive <b>Off-state leakage current:</b> less than 100 mA <b>On-state voltage drop:</b> 3V at 300 mA ac; 2V at 15 mA ac	
<b>Output Protection Circuitry</b>	Protected against false pulse on power-up	
<b>Output Response Time</b>	<b>Opposed Mode:</b> 16 milliseconds ON, 8 milliseconds OFF <b>Polarized Retroreflective and Fixed-field:</b> 16 milliseconds ON/OFF NOTE: 100 millisecond delay on power-up	
<b>Repeatability</b>	<b>Opposed Mode:</b> 2 milliseconds; <b>Polarized Retroreflective and Fixed-field:</b> 4 milliseconds. Repeatability and response are independent of signal strength.	
<b>Indicators</b>	<b>Two LEDs:</b> Green and Yellow <b>Green ON steady:</b> power to sensor is ON <b>Yellow ON steady:</b> sensor sees light <b>Yellow flashing:</b> excess gain marginal (1-1.5x) in light condition	
<b>Construction</b>	Housings are thermoplastic polyester. Lenses are polycarbonate or acrylic; one jam nut included.	
<b>Environmental Rating</b>	Leakproof design rated NEMA 6P, DIN 40050 (IP69K)	
<b>Connections</b>	2 m or 9 m attached cable, or 4 pin Micro-style quick-disconnect fitting. QD cables are ordered separately. See page 386.	
<b>Operating Conditions</b>	<b>Temperature:</b> -40° to +70° C <b>Relative humidity:</b> 90% at 50° C (non-condensing)	
<b>Vibration and Mechanical Shock</b>	All models meet Mil. Std. 202F requirements. Method 201A (Vibration; frequency 10 to 60 Hz, max, double amplitude 0.06-inch acceleration 10G). Method 213B conditions H&I (Shock: 75G with unit operating; 100G for non-operation)	
<b>Certifications</b>		
<b>Hookup Diagrams</b>	<b>Cabled Emitters:</b> AC03 (p. 484) <b>QD Emitters:</b> AC07 (p. 485)	<b>Other Cabled Models:</b> AC05 (p. 485) <b>Other QD Models:</b> AC06 (p. 485)

## X-ON Electronics

Largest Supplier of Electrical and Electronic Components

*Click to view similar products for [banner manufacturer](#):*

Other Similar products are found below :

[Q45VR2FPQ](#) [BTA23S](#) [RS-11](#) [L16F](#) [2LM3](#) [2PBA](#) [LM8-1](#) [LMT](#) [SM312CV](#) [SM31RQD](#) [LS4ELQ](#) [FX1](#) [Q45BB6LLQ](#) [QM42VP6AFV150Q](#)  
[D12SP6FP](#) [MBCC-412](#) [BA23S](#) [BT21S](#) [BTA13S](#) [LM4-2](#) [QS18VN6LP](#) [ES-FA-6G](#) [T183E](#) [SLSP30-600Q88](#) [SLSP30-1200Q88](#)  
[OTBVN6QD](#) [OPBA5](#) [PBAT](#) [SBLV1](#) [SMA91EQD](#) [SMA91E](#) [SMA912LVQD](#) [SMA912DQD](#) [SM2A312CVQD](#) [SM2A912LVQD](#)  
[SM312FP1H](#) [SM31RL](#) [TL70RAQ](#) [TL70RQ](#) [K50LGRYPQ](#) [BRT-THG-4X4-5](#) [T18-2VNDL-Q8](#) [SLLP14-1190P88](#) [SME312DQD](#)  
[SM312CUQD](#) [BR-2](#) [BR23P](#) [SM2A312FPQD](#) [SM2A312LVQD](#) [SM31EQD](#)