

ZH CONNECTOR

1.5mm pitch/Disconnectable Crimp style connectors



The ZH connector is very small with a mounting height of 5.6 mm and a thickness of only 3.5 mm. Contact retention lances on the housing make insertion easier, while the dimple at the center of the contact ensures reliable contact with the post.

- Compact, low profile design
- Housing lances
- Reliable contact construction
- Distortion resistant construction
- Compatible with the ZR insulation displacement connectors

Specifications

- Current rating: 1.0 A AC, DC (AWG #26)
 - Voltage rating: 50 V AC, DC
 - Temperature range: -25°C to +85°C
(including temperature rise in applying electrical current)
 - Contact resistance: Initial value/ 20 mΩ max.
After environmental tests/ 30 mΩ max.
 - Insulation resistance: 500 MΩ min.
 - Withstanding voltage: 500 VAC/minute
 - Applicable wire: AWG #32 to #26
 - Applicable PC board thickness: 0.6 to 1.2 mm, 1.6 mm
- * Refer to "General Instruction and Notice when using Terminals and Connectors" at the end of this catalog.
* Contact JST for details.
* Compliant with RoHS.

Standards

- Ⓜ Recognized E60389
- Ⓢ Certified LR20812

PC board layout and Assembly layout

<Through-hole type (viewed from soldering side) >

Top entry type

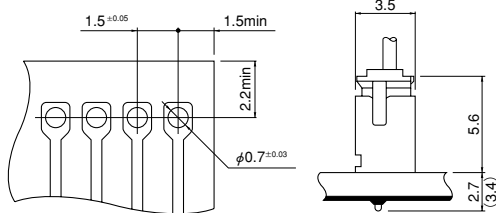

Side entry type

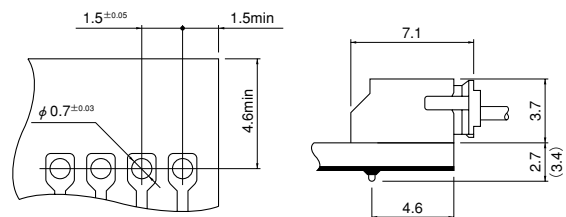

Note: 1. Tolerances are non-cumulative: ±0.05 mm for all centers.

2. Hole dimension differ according to the type of PC board and piercing method. If PC boards made of hard material are used, the hole dimensions should be larger. The dimensions above should serve as a guideline. Contact JST for details.

<SMT type (viewed from component side) >

SM2 type

Side entry type

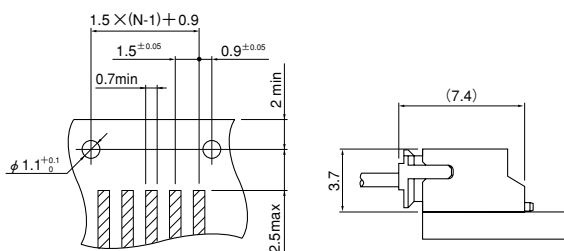

SM4 type

Top entry type

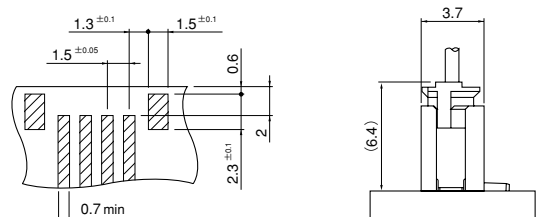

Side entry type

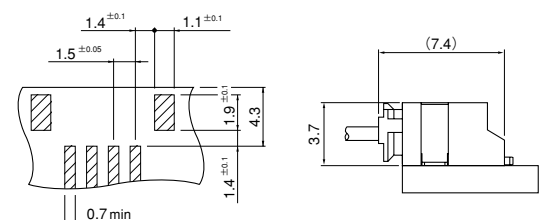

Note: 1. N...Number of circuits

2. Tolerances are non-cumulative: ±0.05 mm for all centers.

3. The dimensions above should serve as a guideline. Contact JST for details.

Contact

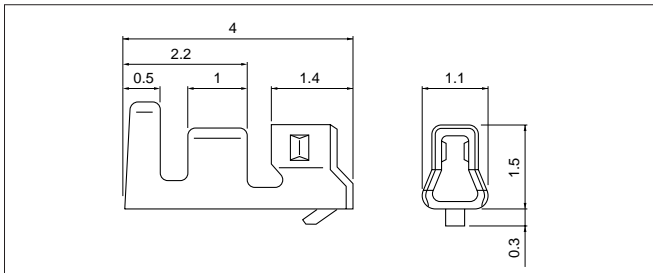

Contact	Crimping machine	Applicator		
		Crimp applicator	Dies	Crimp applicator with dies
SZH-002T-P0.5	AP-K2N	MKS-L	MK/SZH-002-05	APLMK SZH002-05

Note: *Strip-crimp applicator.

Model No.	Applicable wire			Q'ty/reel
	mm ²	AWG#	Insulation O.D. (mm)	
SZH-002T-P0.5	0.08 ~0.13	28~26	0.8~1.1	13,000
SZH-003T-P0.5	0.032~0.08	32~28	0.5~0.9	16,000

Material and Finish

Phosphor bronze, tin-plated (reflow treatment)

RoHS compliance

Contact	Crimping machine	Applicator		
		Crimp applicator	Dies	Crimp applicator with dies
SZH-003T-P0.5	AP-K2N	MKS-L	MK/SZH-003-05	APLMK SZH003-05
		*MKS-SC	SC/SZH-003-05	APLSC SZH003-05

Housing

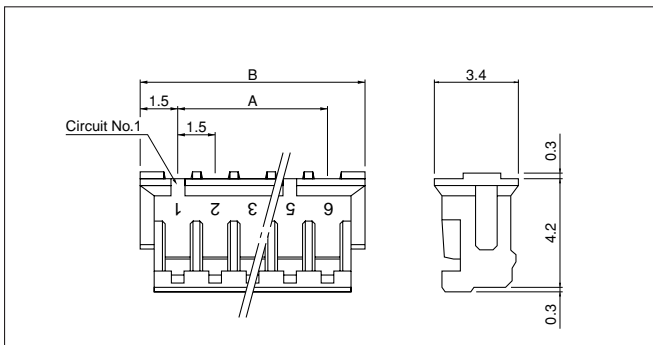

<For reference> As the color identification, the following alphabet shall be put in the underlined part. For availability, delivery and minimum order quantity, contact JST.

ex. **ZHR-2-oo**

(blank)...natural (white)

K...black R...red E...blue M...green L...lemon yellow
LE...light blue DO...dark orange H...gray

Circuits	Model No.	Dimensions (mm)		Q'ty/bag
		A	B	
2	ZHR-2	1.5	4.5	1,000
3	ZHR-3	3.0	6.0	1,000
4	ZHR-4	4.5	7.5	1,000
5	ZHR-5	6.0	9.0	1,000
6	ZHR-6	7.5	10.5	1,000
6	ZHR-6(3.0)	15.0	18.0	1,000
7	ZHR-7	9.0	12.0	1,000
8	ZHR-8	10.5	13.5	1,000
9	ZHR-9	12.0	15.0	1,000
10	ZHR-10	13.5	16.5	1,000
11	ZHR-11	15.0	18.0	1,000
12	ZHR-12	16.5	19.5	1,000
13	ZHR-13	18.0	21.0	1,000

Material

PA 66, UL94V-0, natural (white)

RoHS compliance

Note: 1. ZHR-6(3.0) is 6 circuits 3.0 mm pitch plugged up.
As for this housing, only circuit No.1 is marked.
2. ZHR-6(3.0) is not UL/CSA approved.

Through-hole type shrouded header

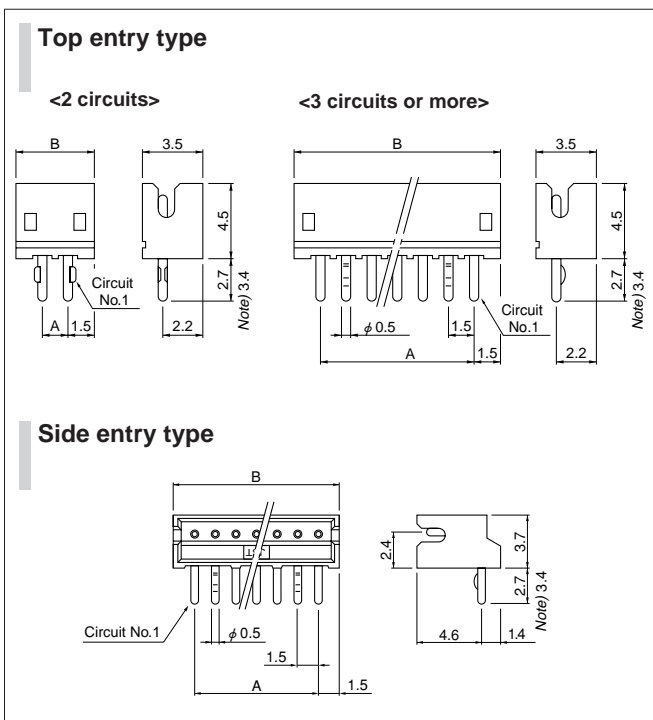

Circuits	Model No.				Dimensions (mm)		Q'ty/box		
	Top entry type	Side entry type	Note) Top entry type	Note) Side entry type	A	B	Top entry type	Side entry type	Side entry type-3.4
2	B2B-ZR	S2B-ZR	B2B-ZR-3.4	S2B-ZR-3.4	1.5	4.5	2,000	2,000	2,000
3	B3B-ZR	S3B-ZR	B3B-ZR-3.4	S3B-ZR-3.4	3.0	6.0	2,000	2,000	1,000
4	B4B-ZR	S4B-ZR	B4B-ZR-3.4	S4B-ZR-3.4	4.5	7.5	2,000	2,000	2,000
5	B5B-ZR	S5B-ZR	B5B-ZR-3.4	S5B-ZR-3.4	6.0	9.0	2,000	1,000	1,000
6	B6B-ZR	S6B-ZR	B6B-ZR-3.4	S6B-ZR-3.4	7.5	10.5	2,000	1,000	1,000
7	B7B-ZR	S7B-ZR	B7B-ZR-3.4	S7B-ZR-3.4	9.0	12.0	1,000	1,000	1,000
8	B8B-ZR	S8B-ZR	B8B-ZR-3.4	S8B-ZR-3.4	10.5	13.5	1,000	1,000	1,000
9	B9B-ZR	S9B-ZR	B9B-ZR-3.4	S9B-ZR-3.4	12.0	15.0	1,000	1,000	1,000
10	B10B-ZR	S10B-ZR	B10B-ZR-3.4	S10B-ZR-3.4	13.5	16.5	1,000	1,000	1,000
11	B11B-ZR	S11B-ZR	B11B-ZR-3.4	S11B-ZR-3.4	15.0	18.0	1,000	500	500
12	B12B-ZR	S12B-ZR	B12B-ZR-3.4	S12B-ZR-3.4	16.5	19.5	1,000	500	500
13	B13B-ZR	S13B-ZR	B13B-ZR-3.4	S13B-ZR-3.4	18.0	21.0	500	500	500

Material and Finish

Pin: Brass, copper-undercoated, tin-plated (reflow treatment)
Wafer: Glass-filled PA 66, UL94V-0, natural (ivory)

RoHS compliance

This product displays (LF)(SN) on a label.
Note: Headers with 3.4 mm long solder tails, suited for the 1.6 mm thick PC board.

<For reference> As the color identification, the following alphabet shall be put in the underlined part. For availability, delivery and minimum order quantity, contact JST.

ex. **B2B-ZR-3.4-oo**

(blank)...natural (ivory)

K...black R...red E...blue M...green Y...Yellow

ZH CONNECTOR

SMT type shrouded header

SM2 type Side entry type

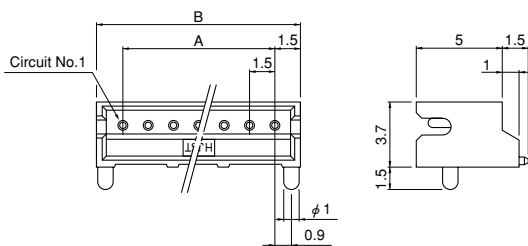

SM2 type

Circuits	Model No.	Dimensions (mm)		Q'ty/ reel	
		Side entry type	A		B
2	S2B-ZR-SM2-TF		1.5	4.5	1,000
3	S3B-ZR-SM2-TF		3.0	6.0	1,000
4	S4B-ZR-SM2-TF		4.5	7.5	1,000
5	S5B-ZR-SM2-TF		6.0	9.0	1,000
6	S6B-ZR-SM2-TF		7.5	10.5	1,000
7	S7B-ZR-SM2-TF		9.0	12.0	1,000
8	S8B-ZR-SM2-TF		10.5	13.5	1,000
9	S9B-ZR-SM2-TF		12.0	15.0	1,000
10	S10B-ZR-SM2-TF		13.5	16.5	1,000
11	S11B-ZR-SM2-TF		15.0	18.0	1,000
12	S12B-ZR-SM2-TF		16.5	19.5	1,000
13	S13B-ZR-SM2-TF		18.0	21.0	1,000

Material and Finish

Pin: Brass, copper-undercoated, tin-plated (reflow treatment)
Wafer: Glass-filled PA 46, UL94V-0, natural (ivory)

RoHS compliance This product displays (LF)(SN) on a label.

SM4 type (with solder tabs) Top entry type

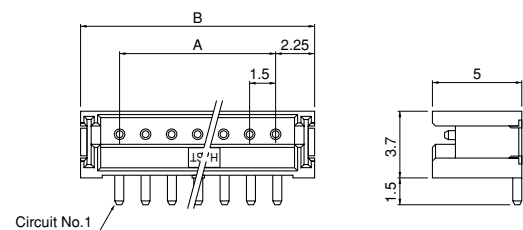

SM4 type

Circuits	Model No.		Dimensions (mm)		Q'ty/reel	
	Top entry type	Side entry type	A	B	Top entry type	Side entry type
2	B2B-ZR-SM4-TF	S2B-ZR-SM4A-TF	1.5	6.0	1,000	1,000
3	B3B-ZR-SM4-TF	S3B-ZR-SM4A-TF	3.0	7.5	1,000	1,000
4	B4B-ZR-SM4-TF	S4B-ZR-SM4A-TF	4.5	9.0	1,000	1,000
5	B5B-ZR-SM4-TF	S5B-ZR-SM4A-TF	6.0	10.5	1,000	1,000
6	B6B-ZR-SM4-TF	S6B-ZR-SM4A-TF	7.5	12.0	1,000	1,000
7	B7B-ZR-SM4-TF	S7B-ZR-SM4A-TF	9.0	13.5	1,000	1,000
8	B8B-ZR-SM4-TF	S8B-ZR-SM4A-TF	10.5	15.0	1,000	1,000
9	B9B-ZR-SM4-TF	S9B-ZR-SM4A-TF	12.0	16.5	1,000	1,000
10	B10B-ZR-SM4-TF	S10B-ZR-SM4A-TF	13.5	18.0	1,000	1,000
11	B11B-ZR-SM4-TF	S11B-ZR-SM4A-TF	15.0	19.5	1,000	1,000
12	B12B-ZR-SM4-TF	S12B-ZR-SM4A-TF	16.5	21.0	1,000	1,000
13	B13B-ZR-SM4-TF	S13B-ZR-SM4A-TF	18.0	22.5	1,000	1,000

Material and Finish

Pin: Brass, copper-undercoated, tin-plated (reflow treatment)
Wafer: PA 6T, UL94V-0, natural (ivory)
Solder tab: Brass, copper-undercoated, tin-plated (reflow treatment)

RoHS compliance This product displays (LF)(SN) on a label.

Note: 1. PA 9T is used for some colored products.

2. The products listed above are supplied on embossed-tape.

3. Contact JST for the top entry type headers with suction cap.

<For reference> As the color identification, the following alphabet shall be put in the underlined part. For availability, delivery and minimum order quantity, contact JST.

ex. **S2B-ZR-SM4A-oo-TF**

(blank)...natural (ivory)

K...black R...red E...blue M...green L...lemon yellow

LE...light blue DO...dark orange DH...dark gray

Side entry type

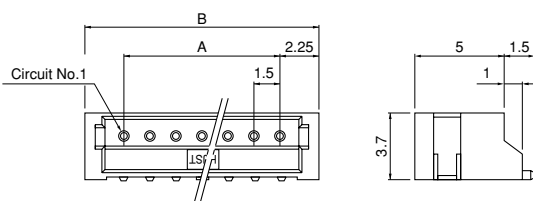

X-ON Electronics

Largest Supplier of Electrical and Electronic Components

Click to view similar products for [Headers & Wire Housings](#) category:

Click to view products by [JST](#) manufacturer:

Other Similar products are found below :

[95000-104TRLF](#) [10135584-644402LF](#) [DF62W-EP2022PCA](#) [95000-106TRLF](#) [DF62W-2022SCA](#) [DF62W-EP2022PC](#) [2203348](#) [DF62W-2022SC](#) [1084018](#) [1029039](#) [1084017](#) [802-10-012-10-002000](#) [1112640](#) [1112639](#) [000-34000](#) [0009482033](#) [0009507031](#) [57102-S06-03LF](#) [57202-S52-04LF](#) [PCN6-15S-2.5E](#) [0039019024](#) [58102-G61-06LF](#) [582553-1](#) [0009485154](#) [0009508121](#) [0022285053](#) [0050291907](#) [018731A](#) [LY20-4P-DT1-P1E-BR](#) [02.125.8002.8](#) [60101931](#) [60598-1 \(Cut Strip\)](#) [M1625-3R/100](#) [61062-3](#) [61082-181009](#) [636-1427](#) [638009-1](#) [641938-9](#) [641991-4](#) [644168-1](#) [647662-1](#) [65039-019ELF](#) [65817-002LF](#) [65817-015LF](#) [65863-015LF](#) [66207-023LF](#) [67016-026LF](#) [67046-001LF](#) [67095-007LF](#) [67230-005LF](#)