



Typical Applications

The HMC6505LC5 is ideal for:

- Point-to-Point and Point-to-Multi-Point Radio
- Military Radar, EW & ELINT
- Satellite Communications
- Sensors

Functional Diagram

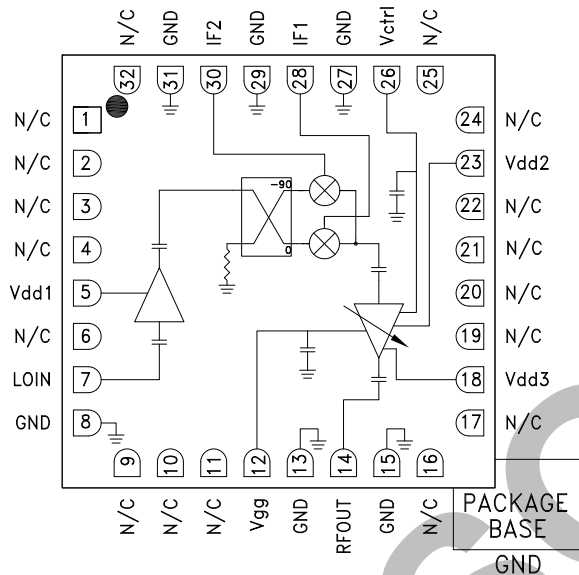

HMC6505LC5

GaAs MMIC I/Q UPCONVERTER

5.5 - 8.6 GHz

Features

- High Conversion Gain: 15 dB
- Sideband Rejection: 22 dBc
- LO / RF Rejection: 14 dBc
- High Output IP3: +35 dBm
- 32 Lead 5x5 mm SMT Ceramic Package: 25 mm²

General Description

The HMC6505LC5 is a compact GaAs MMIC I/Q upconverter in a leadless RoHS compliant SMT package. This device provides a small signal conversion gain of 15 dB with 22 dBc of sideband rejection. The HMC6505LC5 utilizes a RF amplifier preceded by an I/Q mixer where the LO is driven by a driver amplifier. IF1 and IF2 mixer inputs are provided and an external 90° hybrid is needed to select the required sideband. The I/Q mixer topology reduces the need for filtering of the unwanted sideband. The HMC6505LC5 is a much smaller alternative to hybrid style single sideband upconverter assemblies and it eliminates the need for wire bonding by allowing the use of surface mount manufacturing techniques.

Electrical Specifications, $T_A = +25^\circ\text{C}$, $IF = 350\text{ MHz}$,

$LO = +4\text{ dBm}$, $V_{dd2,3} = +5\text{V}$, $I_{dd2} + I_{dd3} = 120\text{ mA}$, $V_{dd1} = +5\text{V}$, $I_{dd1} = 125\text{ mA}$ [1][2][6]

Parameter	Min.	Typ.	Max.	Min.	Typ.	Max.	Units
Frequency Range, RF		5.5 - 7		7 - 8.6			GHz
Frequency Range, LO		5 - 10		6.5 - 11.6			GHz
Frequency Range, IF		DC - 3		DC - 3			GHz
Conversion Gain [5]	12	15		11	14		dB
Sideband Rejection	18	22		18	22		dBc
1 dB Compression (Output)		21			22		dBm
IP3 (Output)	31	35		31	35		dBm
LO / RF Rejection [3][4]	7	10		11	14		dBc
RF Return Loss		16			17		dB
LO Return Loss		8			9		dB
IF1 Return Loss		10			10		dB
IF2 Return Loss		8			8		dB
Supply Current I _{dd1}		125			125		mA
Supply Current I _{dd2} + I _{dd3} [2]		120			120		mA

[1] Unless otherwise noted all measurements performed with high side LO, IF = 350 MHz and external IF 90° hybrid.

[2] Adjust V_{gg} between -2 to 0V to achieve I_{dd2} + I_{dd3} = 120 mA Typical.

[3] The LO / RF Rejection is defined as the LO signal level at the RF output port relative to the desired RF output signal level.

[4] The LO / RF Rejection data is with IF = -6 dBm.

[5] Data based on subtracting out board loss and loss of hybrid.

[6] +3V can also be used for V_{dd1}.



Electrical Specifications, (continued) [1]

Parameter	Min.	Typ.	Max.	Min.	Typ.	Max.	Units
Frequency Range, RF		5.5 - 7		7 - 8.6			GHz
Frequency Range, LO		5 - 10		6.5 - 11.6			GHz
Frequency Range, IF		DC - 3		DC - 3			GHz
Dynamic Range	18	20		18	20		dB
V Control	-4		0	-4		0	V
LO Power	-2	3	10	-2	3	10	dBm
Gain Flatness (150 MHz Segments)			0.5			0.5	dB
Noise Figure (Min Attenuation) [7]		11.5			12		dB

[1] Unless otherwise noted all measurements performed with high side LO, IF = 350 MHz and external IF 90° hybrid.

[7] Noise Figure measurement performed with high side LO, IF = 2500 MHz and external IF 90° hybrid.

Data Taken as SSB Upconverter with External IF 90° Hybrid, IF = 350 MHz

Conversion Gain, LSB vs. Temperature [8]

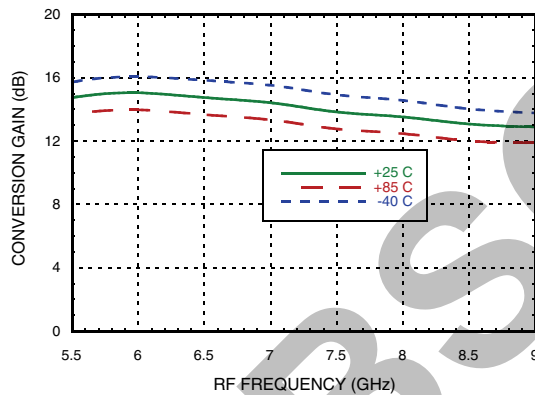

Conversion Gain, LSB vs. LO Drive [8]

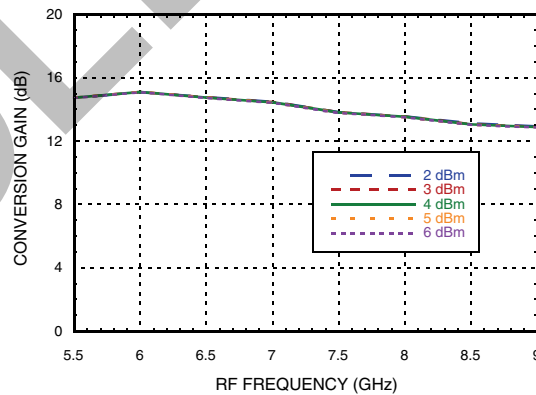

RF Return Loss vs. Temperature

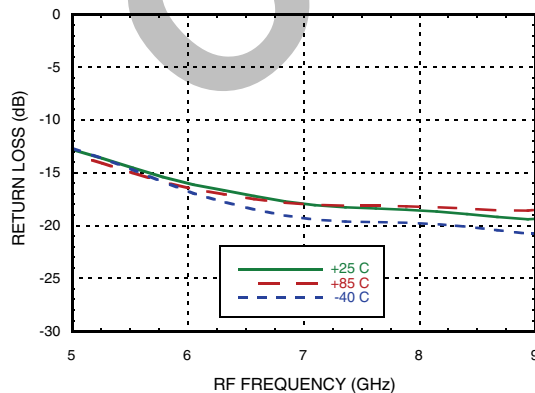

LO Return Loss vs. Temperature

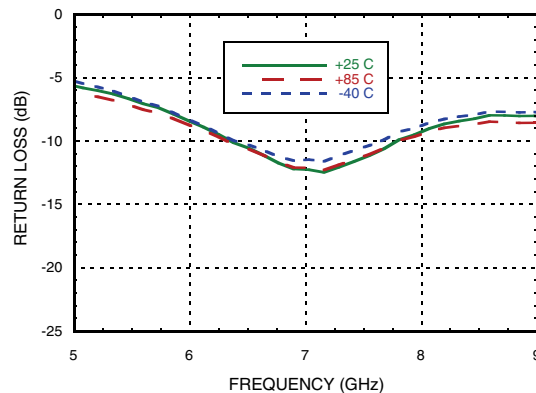

[8] Board loss and Hybrid loss not subtracted out.

**GaAs MMIC I/Q UPCONVERTER
5.5 - 8.6 GHz**

Data Taken as SSB Upconverter with External IF 90° Hybrid, IF = 350 MHz

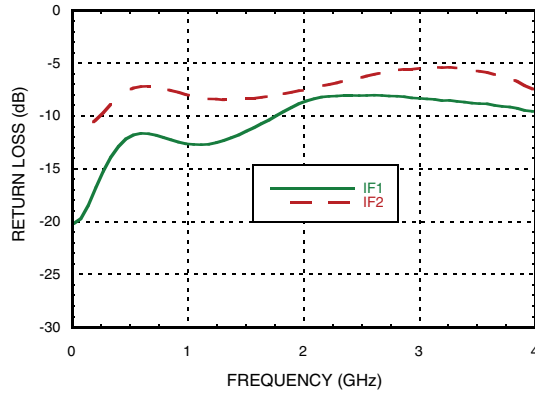
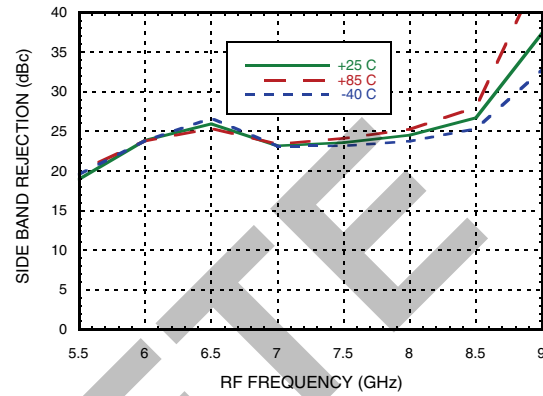
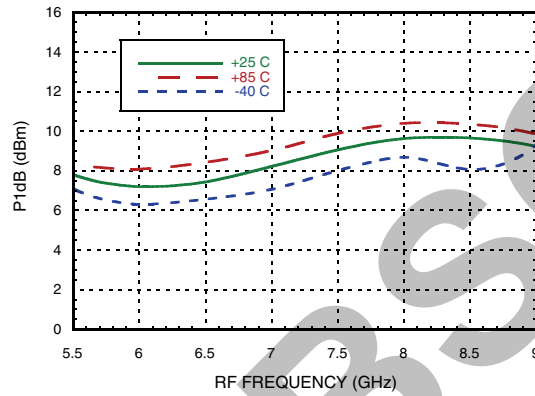
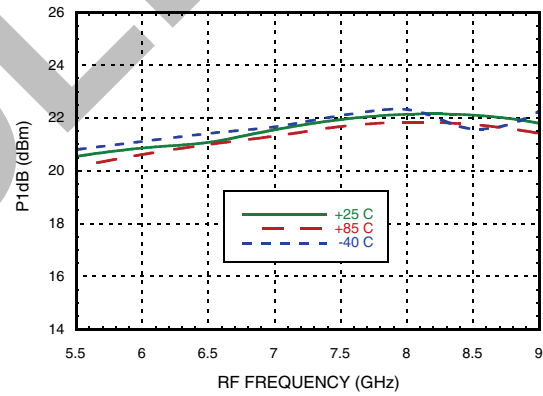
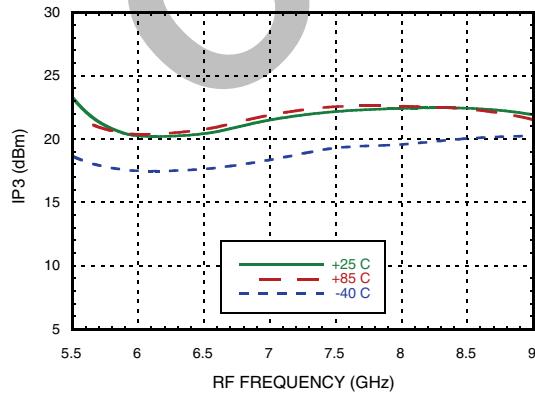
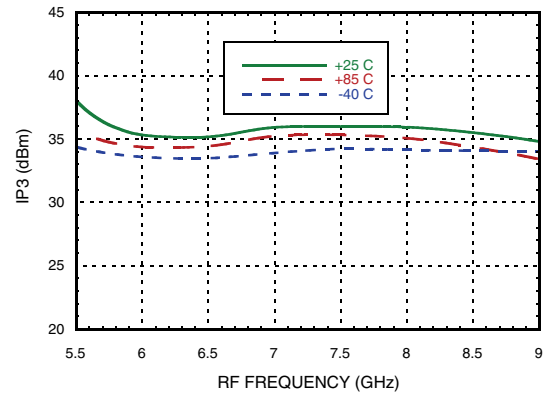
IF Return Loss [9]

Sideband Rejection vs. Temperature

Input P1dB, LSB vs. Temperature

Output P1dB, LSB vs. Temperature

Input IP3, LSB vs. Temperature

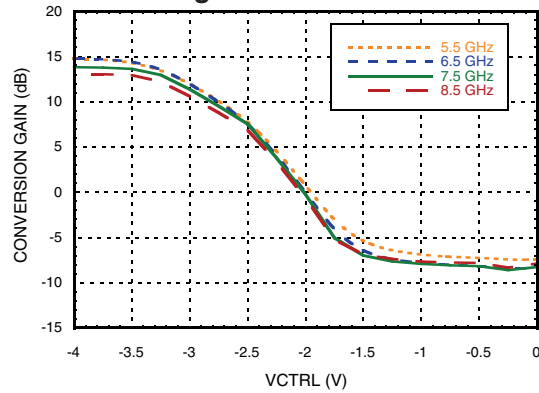
Output IP3, LSB vs. Temperature

[9] Data taken without external IF 90° hybrid



**GaAs MMIC I/Q UPCONVERTER
5.5 - 8.6 GHz**

Data Taken as SSB Upconverter with External IF 90° Hybrid, IF = 350 MHz

Conversion Gain, LSB vs. Control Voltage [8]

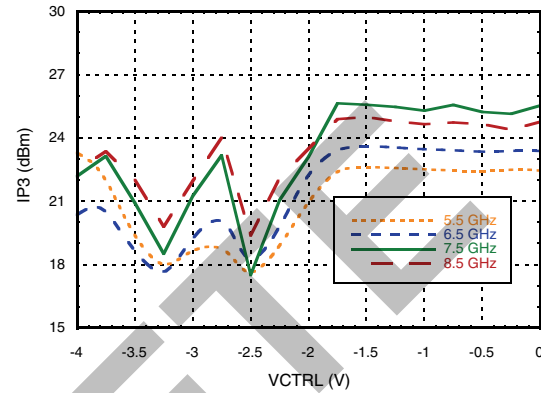

Input IP3, LSB vs. Control Voltage



LO/RF Rejection, LSB

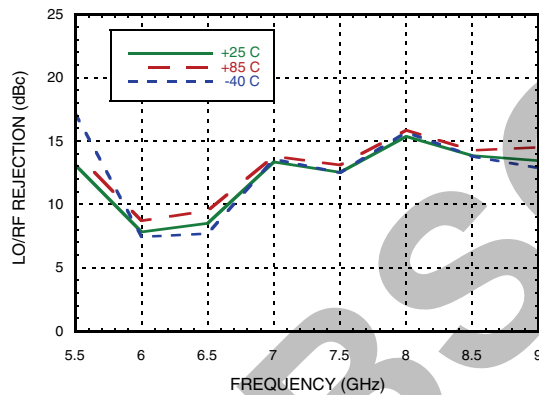

Isolation

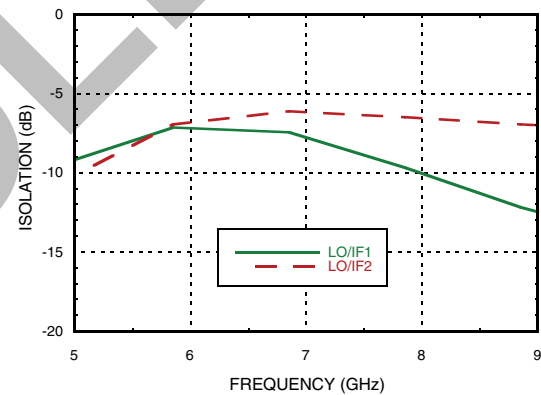

[8] Board loss and Hybrid loss not subtracted out.

Data Taken as SSB Upconverter with External IF 90° Hybrid, IF = 2500 MHz

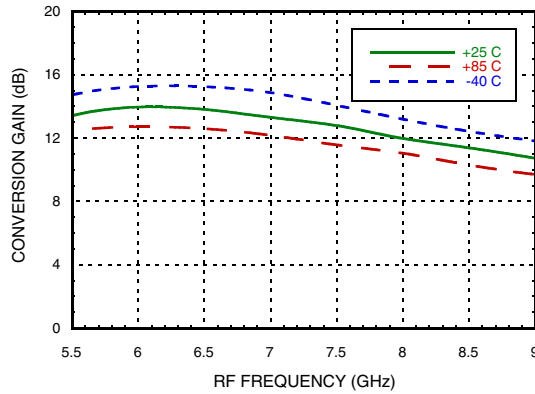
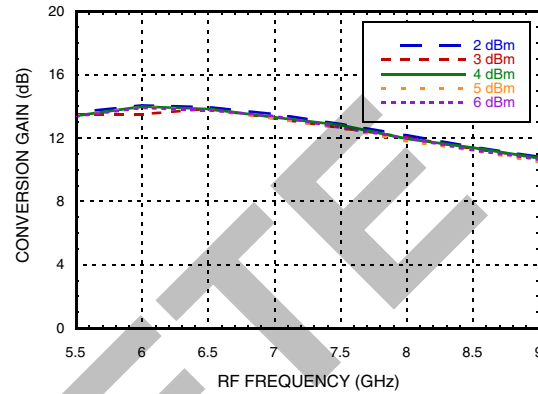
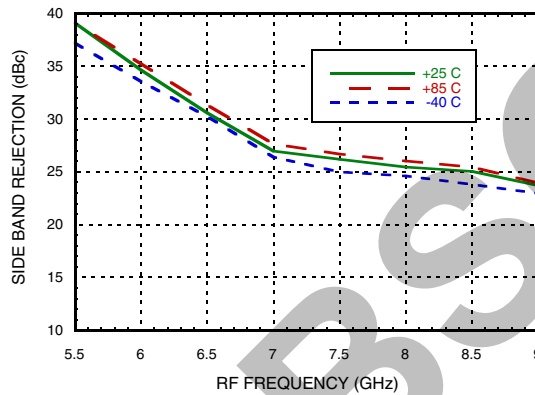
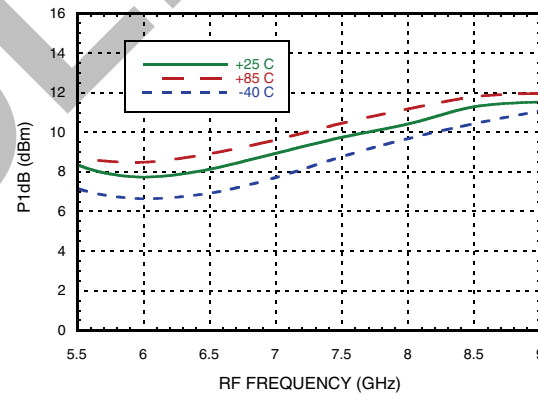
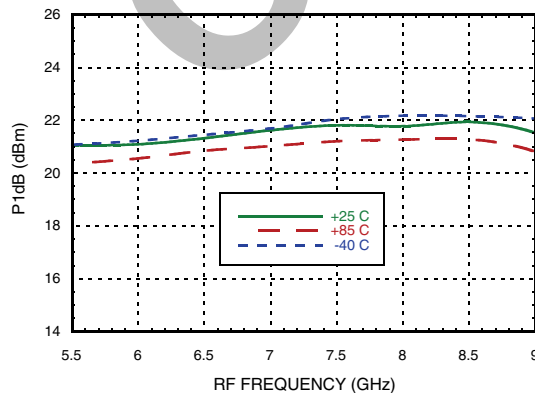
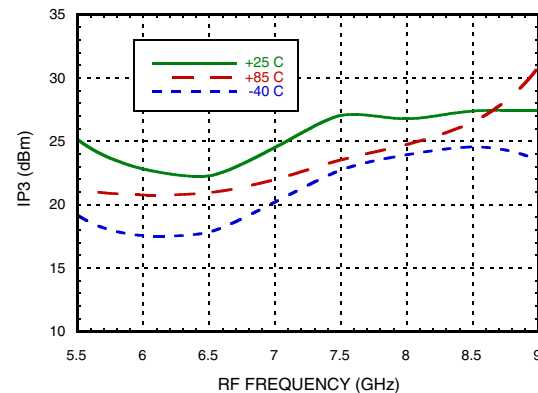
Conversion Gain, LSB vs. Temperature [8]

Conversion Gain, LSB vs. LO Drive [8]

Sideband Rejection vs. Temperature

Input P1dB, LSB vs. Temperature

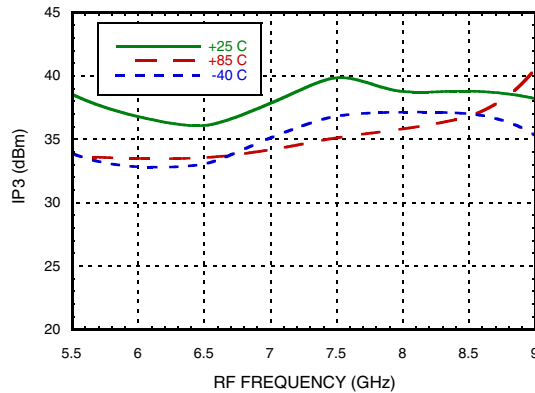
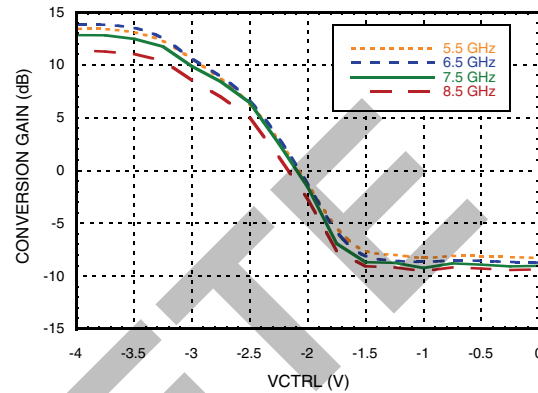
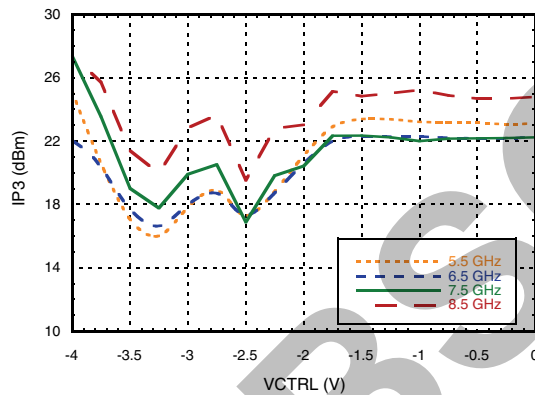
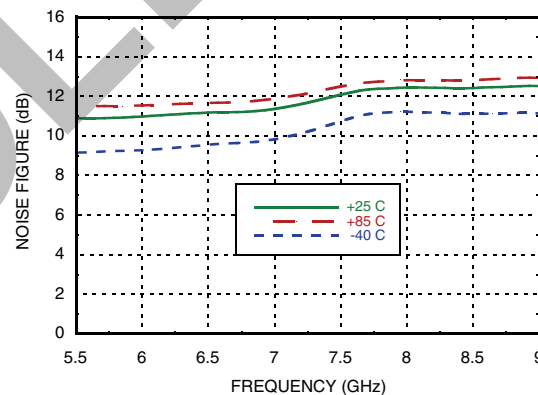
Output P1dB, LSB vs. Temperature

Input IP3, LSB vs. Temperature

[8] Board loss and Hybrid loss not subtracted out.

**GaAs MMIC I/Q UPCONVERTER
5.5 - 8.6 GHz**

Data Taken as SSB Upconverter with External IF 90° Hybrid, IF = 2500 MHz

Output IP3, LSB vs. Temperature

Conversion Gain, LSB vs. Control Voltage [8]

Input IP3, LSB vs. Control Voltage

**Noise Figure, LSB vs. Temperature
Minimum Attenuation**

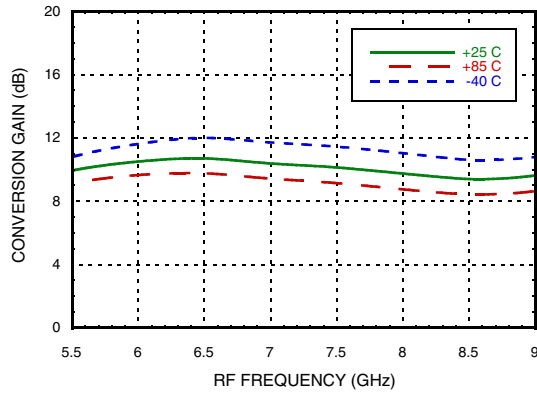
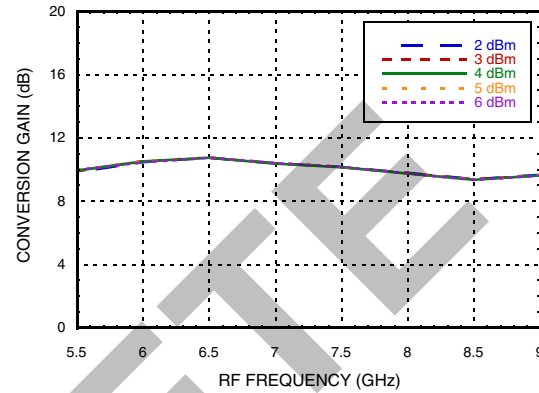
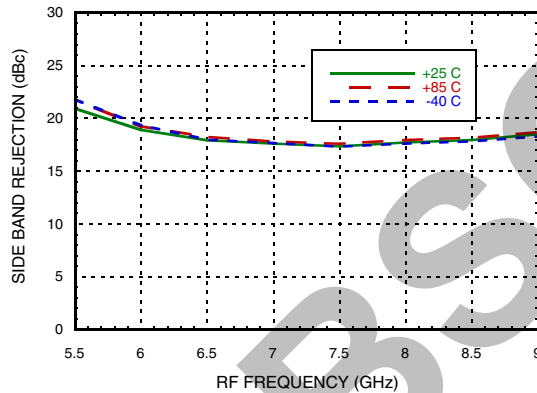
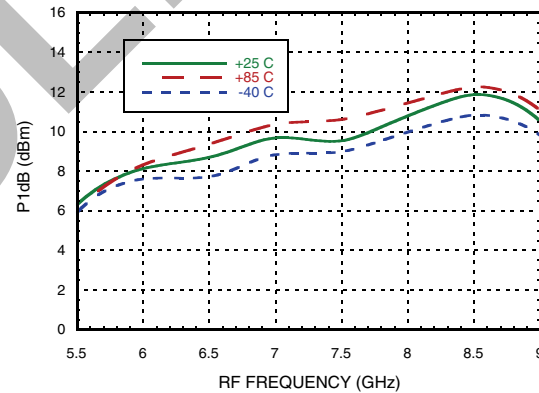
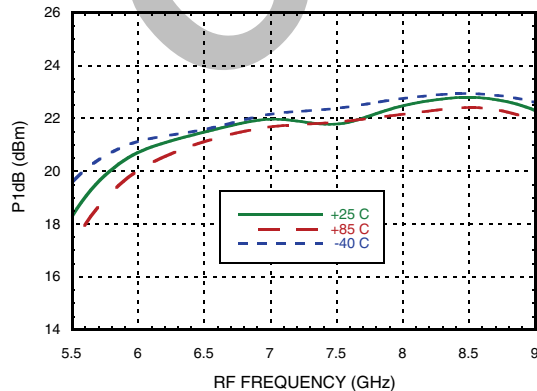
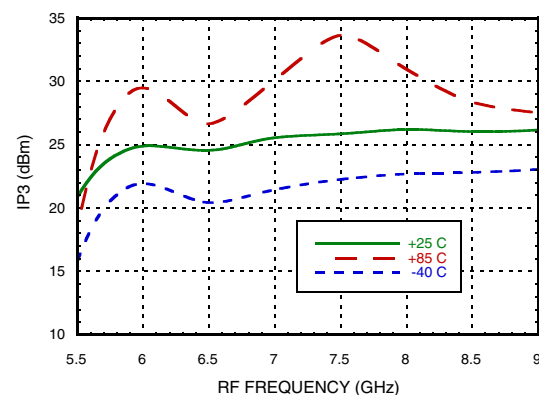
[8] Board loss and Hybrid loss not subtracted out.



Data Taken as SSB Upconverter with External IF 90° Hybrid, IF = 350 MHz

Conversion Gain, USB vs. Temperature [8]

Conversion Gain, USB vs. LO Drive [8]

Sideband Rejection vs. Temperature

Input P1dB, USB vs. Temperature

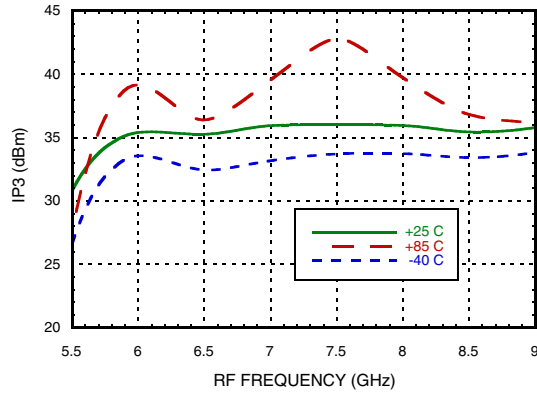
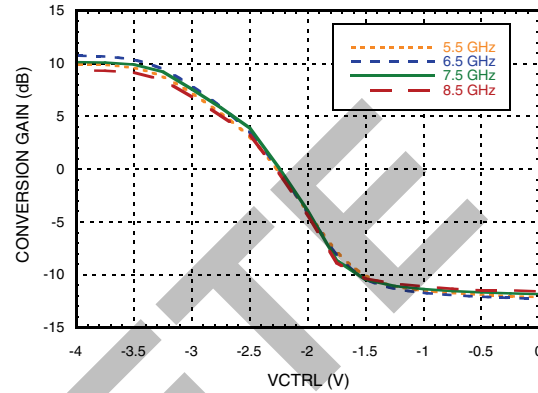
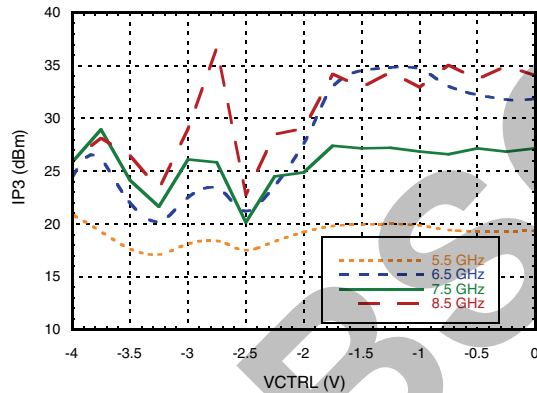
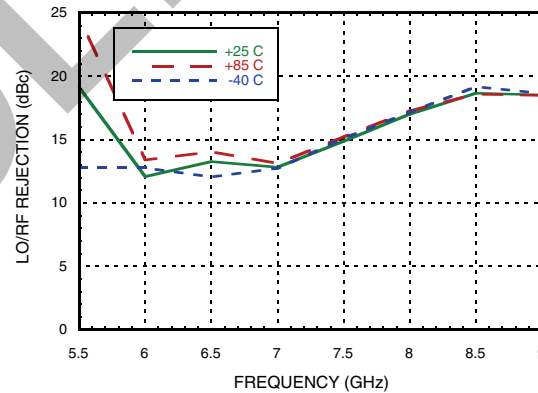
Output P1dB, USB vs. Temperature

Input IP3, USB vs. Temperature

[8] Board loss and Hybrid loss not subtracted out.

**GaAs MMIC I/Q UPCONVERTER
5.5 - 8.6 GHz**

Data Taken as SSB Upconverter with External IF 90° Hybrid, IF = 350 MHz

Output IP3, USB vs. Temperature

Conversion Gain, USB vs. Control Voltage [8]

Input IP3, USB vs. Control Voltage

LO/RF Rejection, USB

[8] Board loss and Hybrid loss not subtracted out.

GaAs MMIC I/Q UPCONVERTER 5.5 - 8.6 GHz



Data Taken as SSB Upconverter with External IF 90° Hybrid, IF = 2500 MHz

Conversion Gain, USB vs. Temperature ^[8]

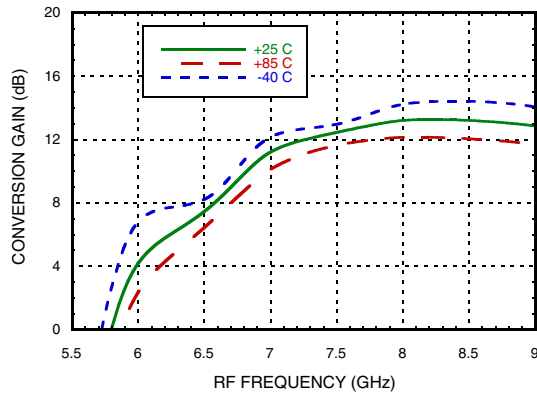

Conversion Gain, USB vs. LO Drive ^[8]

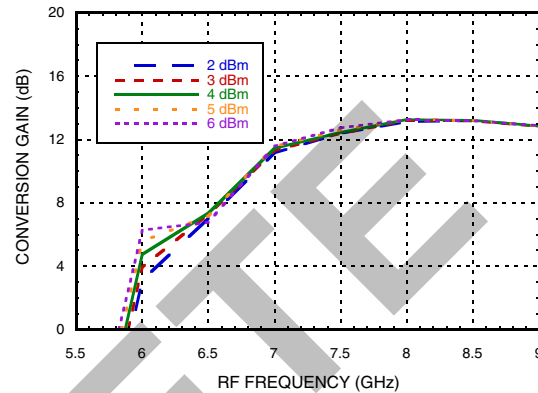

Sideband Rejection vs. Temperature

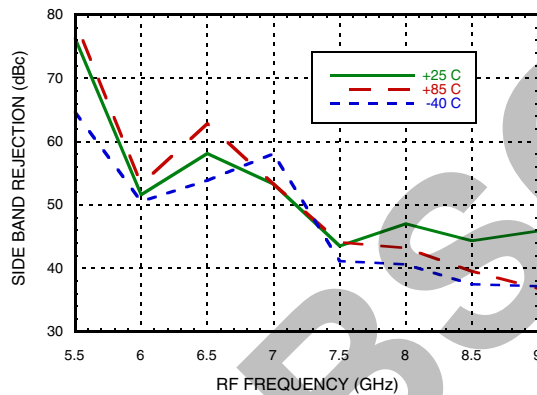

Input P1dB, USB vs. Temperature

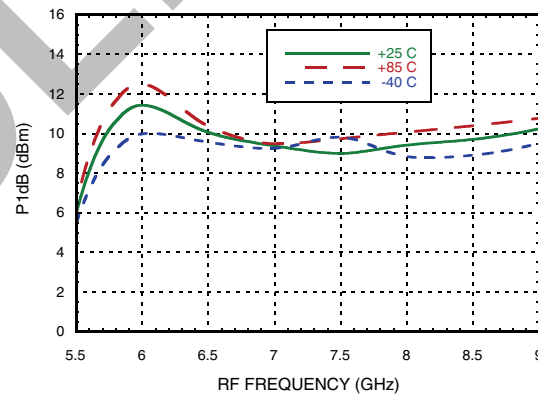

Output P1dB, USB vs. Temperature

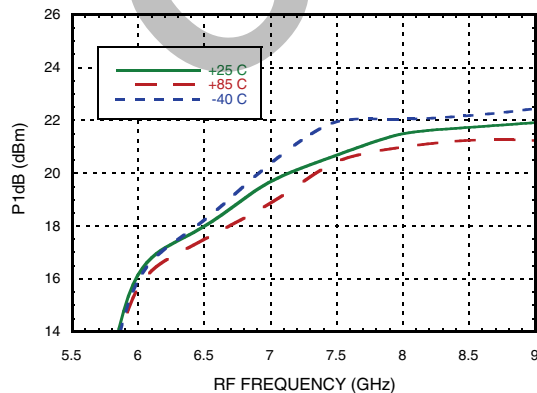

Input IP3, USB vs. Temperature

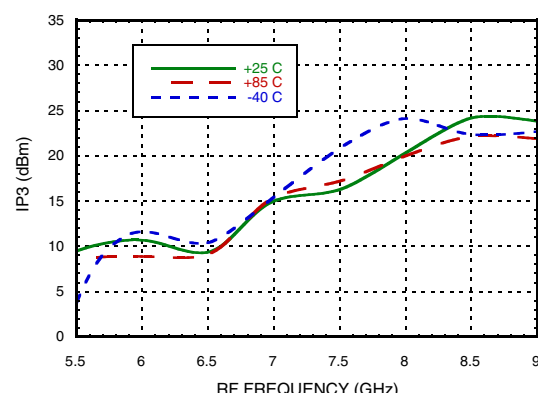

[8] Board loss and Hybrid loss not subtracted out.

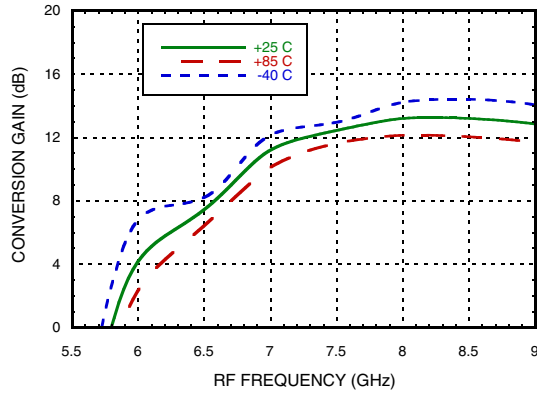
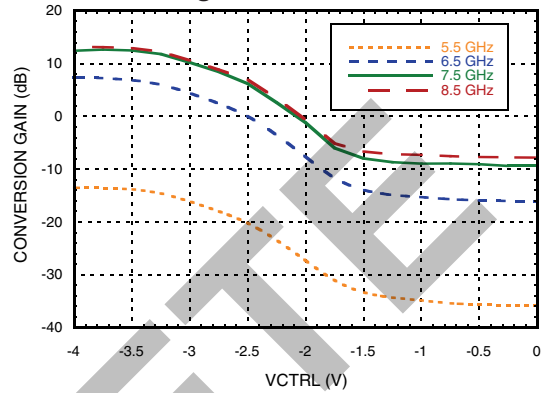
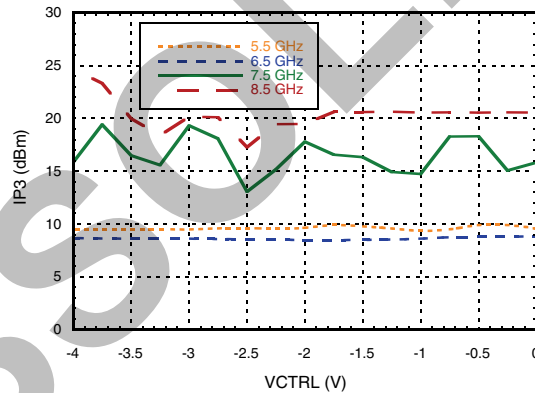

Data Taken as SSB Upconverter with External IF 90° Hybrid, IF = 2500 MHz

Output IP3, USB vs. Temperature

Conversion Gain, USB vs. Control Voltage [8]

Input IP3, USB vs. Control Voltage

[8] Board loss and Hybrid loss not subtracted out.

MxN Spurious Outputs [1][2]

mIF	nLO				
	0	1	2	3	4
0	x	17.3	35.1	57.5	62.6
+1	80.6	0	39.6	66.4	93.3
+2	49.9	64.3	40.6	72.3	91.5
+3	96.7	57.8	87.4	78.5	89.8
+4	88.5	100.8	89.3	94.2	91.7

IF = 0.35 GHz @ -6 dBm
LO = 8.5 GHz @ 0 dBm

mIF	nLO				
	0	1	2	3	4
0	x	15.1	36.4	50.4	61.5
+1	66.7	0	42.9	56.5	83.2
+2	49.2	47.1	39.9	76.5	84.6
+3	95.2	58.9	79.4	76	94.2
+4	86.9	102.5	86.5	96.8	96.1

IF = 0.35 GHz @ -6 dBm
LO = 7.7 GHz @ 0 dBm

mIF	nLO				
	0	1	2	3	4
0	x	11.6	23.6	38.4	60.1
+1	59.8	0	42.9	45.4	70.9
+2	48.5	50.4	39.4	79.9	76.7
+3	86.9	61	87.5	76.2	94.3
+4	85.2	82.4	86.2	97	95.7

IF = 0.35 GHz @ -6 dBm
LO = 7.0 GHz @ 0 dBm

MxN Spurious Outputs [1][3]

mIF	nLO				
	0	1	2	3	4
0	x	17.3	35.1	56.5	62.7
-1	80.6	0	42.8	62.9	93
-2	49.9	53.3	39.3	72.9	90.3
-3	96.9	56	90	75	93
-4	88.2	101.9	89.4	96.1	91.1

IF = 0.35 GHz @ -6 dBm
LO = 8.5 GHz @ 0 dBm

mIF	nLO				
	0	1	2	3	4
0	x	15	36.4	50.6	60.1
-1	66.6	0	48.2	51.4	82.8
-2	49.2	47	38.1	79.7	79.9
-3	95.9	56.7	86.7	75.4	93.1
-4	86.9	94	88.3	97.4	93.8

IF = 0.35 GHz @ -6 dBm
LO = 7.7 GHz @ 0 dBm

mIF	nLO				
	0	1	2	3	4
0	x	11.6	23.5	38.3	58.7
-1	59.7	0	46.7	36.9	73.4
-2	48.6	53	37.7	75.2	69.1
-3	87	58	75	70.9	91.1
-4	84.8	87	83.6	99.5	93.1

IF = 0.35 GHz @ -6 dBm
LO = 7.0 GHz @ 0 dBm

- [1] Data taken without external IF 90° hybrid
 [2] All values in dBc below RF power level (LO + IF) USB
 [3] All values in dBc below RF power level (LO - IF) LSB

Absolute Maximum Ratings

IF Input	+20 dBm
LO Input	+10 dBm
Vctrl	-5V to +0.3V
Vdd1	+5.5V
Vdd2 and Vdd3	+5.5V
Vgg	-3V to 0V
Channel Temperature	175 °C
Continuous P _{diss} (T = 85°C) (derate 18.3 mW/°C above 85°C)	1.65 W
Thermal Resistance (channel to ground paddle)	54.6 °C/W
Storage Temperature	-65 to +150 °C
Operating Temperature	-40 to +85 °C
ESD Sensitivity (HBM)	Class1A

 ELECTROSTATIC SENSITIVE DEVICE
OBSERVE HANDLING PRECAUTIONS

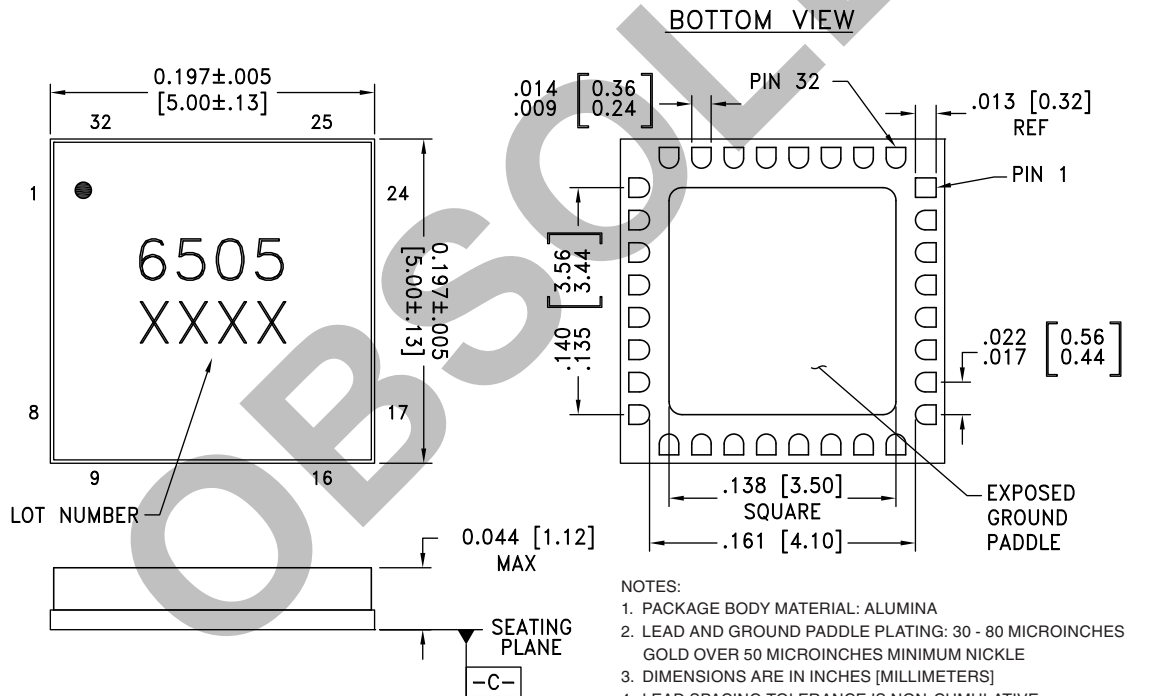
Outline Drawing

NOTES:

1. PACKAGE BODY MATERIAL: ALUMINA
2. LEAD AND GROUND PADDLE PLATING: 30 - 80 MICROINCHES GOLD OVER 50 MICROINCHES MINIMUM NICKLE
3. DIMENSIONS ARE IN INCHES [MILLIMETERS]
4. LEAD SPACING TOLERANCE IS NON-CUMULATIVE
5. PACKAGE WARP SHALL NOT EXCEED 0.05mm DATUM
6. ALL GROUND LEADS AND GROUND PADDLE MUST BE SOLDERED TO PCB RF GROUND

Package Information



Part Number	Package Body Material	Lead Finish	MSL Rating	Package Marking ^[2]
HMC6505LC5	Alumina, White	Gold over Nickel	MSL3 ^[1]	6505 XXXX

[1] Max peak reflow temperature of 260 °C

[2] 4-Digit lot number XXXX

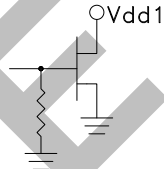
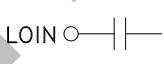

Pin Descriptions

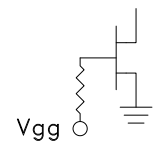
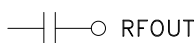
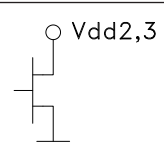
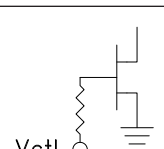
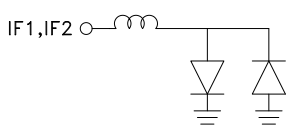
Pin Number	Function	Description	Interface Schematic
1 - 4, 6, 9 - 11, 16, 17, 19, 20, 21, 22, 24, 25, 32	N/C	No connection required. The pins are not connected internally; however, all data shown herein was measured with these pins connected to RF/DC ground externally.	
5	Vdd1	Power supply voltage for LO amplifier. See application circuit for required external components.	
7	LOIN	This pin is AC coupled and matched to 50 Ohms.	
8, 13, 15, 27, 29, 31	GND	These pins and package bottom must be connected to RF/DC ground.	
12	Vgg	Gate control for RF amplifier, please follow "MMIC Amplifier Biasing Procedure" application note. See application circuit for required external components.	
14	RFOUT	This pin is AC coupled and matched to 50 Ohms.	
18, 23	Vdd3, Vdd2	Power supply voltage for RF amplifier. See application circuit for required external components.	
26	Vctrl	Gain Control Voltage for RF Amplifier	
28	IF1	Differential IF input pins. For applications not requiring operation to DC, an off chip DC blocking capacitor should be used. For operation to DC this pin must not source/sink more than 3mA of current or part non function and possible part failure will result.	
30	IF2		

Typical Application

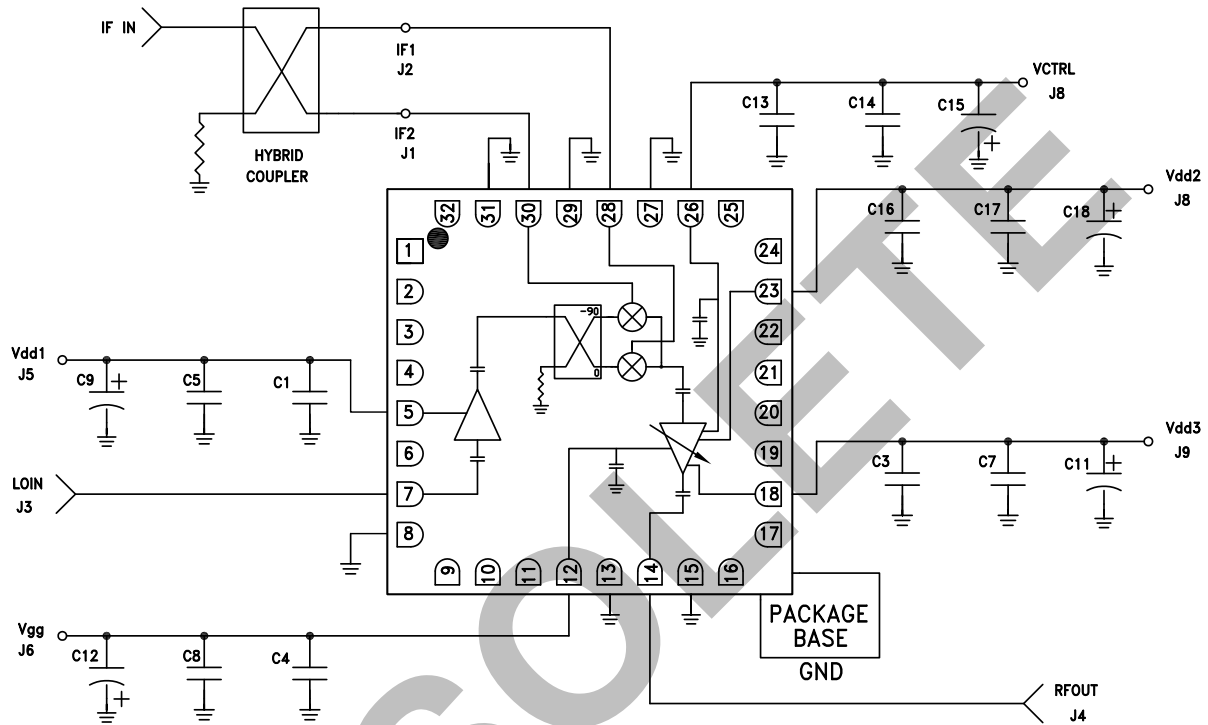

C1, C3, C4, C13, C16	100 pF Capacitor, 0402 Pkg.
C5, C7, C8, C14, C17	1000 pF Capacitor, 0603 Pkg.
C9, C11, C12, C15, C18	2.2 μ F Capacitor, Case A Pkg.

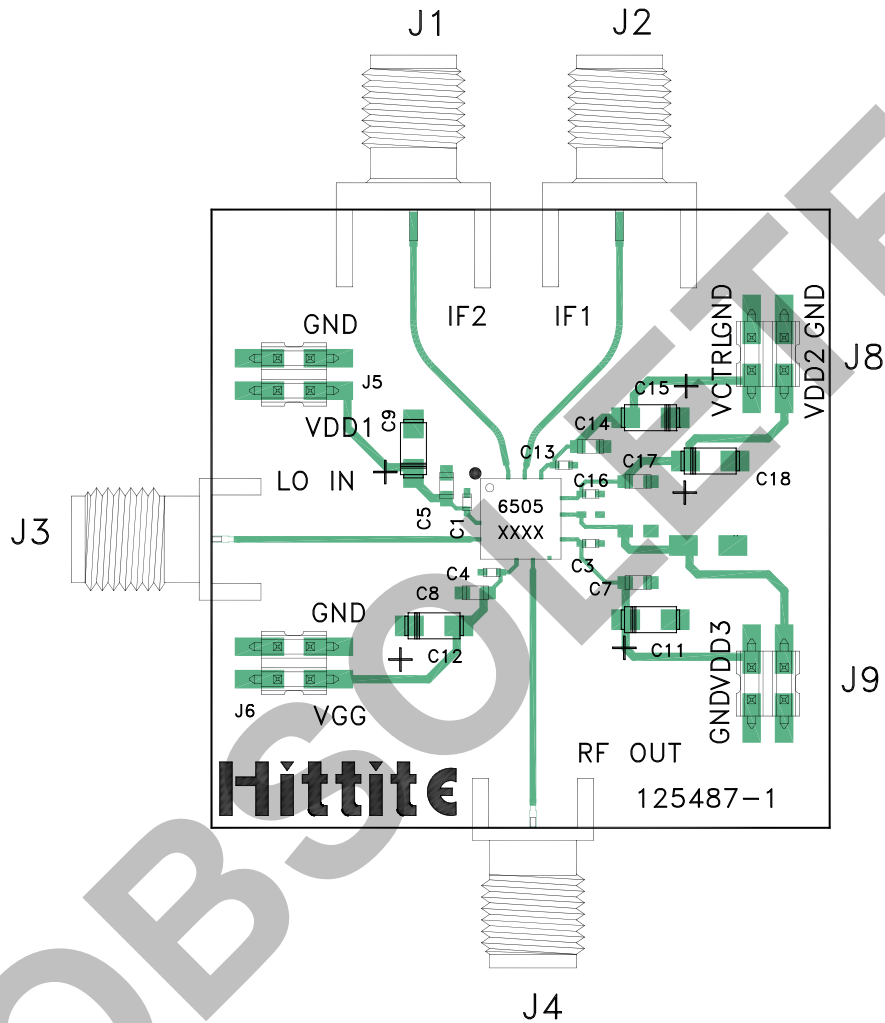
Evaluation PCB

List of Materials for Evaluation PCB Eval01-HMC6505LC5 [1]

Item	Description
J1, J2	SMA Connector
J3, J4	K-Connector SRI
J5, J6, J8, J9	DC Pins
C1, C3, C4, C13, C16	100 pF Capacitor, 0402 Pkg.
C5, C7, C8, C14, C17	1000 pF Capacitor, 0603 Pkg.
C9, C11, C12, C15, C18	2.2 μ F Capacitor, Case A
U1	HMC6505LC5 Upconverter
PCB [2]	125487 Evaluation Board

[1] Reference this number when ordering complete evaluation PCB

[2] Circuit Board Material: Arlon 25FR, FR4 or Rogers 4350

The circuit board used in the application should use RF circuit design techniques. Signal lines should have 50 Ohm impedance while the package ground leads and exposed paddle should be connected directly to the ground plane similar to that shown. A sufficient number of via holes should be used to connect the top and bottom ground planes. The evaluation circuit board shown is available from Hittite upon request.



MICROWAVE CORPORATION v02.0413



HMC6505LC5

GaAs MMIC I/Q UPCONVERTER
5.5 - 8.6 GHz

Notes:

OBSOLETE

X-ON Electronics

Largest Supplier of Electrical and Electronic Components

Click to view similar products for [Up-Down Converters](#) category:

Click to view products by [Analog Devices](#) manufacturer:

Other Similar products are found below :

[HMC7586-SX](#) [HMC8120-SX](#) [HMC8121-SX](#) [HMC7587](#) [HMC8118](#) [HMC8118-SX](#) [HMC7587-SX](#) [MAX2680AUT+T](#) [MAX9996ETP+T](#)
[ADMV4530ACCZ](#) [F1102NBGI8](#) [HMC6147ALC5ATR](#) [MDS-158-PIN](#) [LA8153QA-WH](#) [HMC7912LP5ETR](#) [HMC377QS16GETR](#)
[HMC1090LP3ETR](#) [F1162NBGI](#) [F1178NBGI](#) [MD-123-PIN](#) [ADRF6780ACPZN-R7](#) [MAX9993ETP+](#) [MAX9996ETP+](#) [SM5T](#) [SKY73062-11](#)
[MAX2680EUT+T](#) [MAX2671EUT+T](#) [MAX19997AETX+](#) [MAX19993ETX+](#) [MAX19985AETX+](#) [MAMXSS0012TR-3000](#) [MY63C](#) [MY87C](#)
[M2A](#) [CSM2-10](#) [CSM1-13](#) [CHR3762-QDG](#) [MAX2671EUT-T](#) [MAX19994AETX+](#) [MAX2663EUT+T](#) [MAX19999ETX+](#) [MAX19995ETX+](#)
[TGC4408-SM](#) [TGC4510-SM](#) [TGC4610-SM](#) [TGC4407-SM](#) [TGC2510-SM](#) [MY63H](#) [HMC904LC5TR](#) [ADRF6658BCPZ-RL7](#)