

# 8x2 LINE COMMON MODE CHOKES

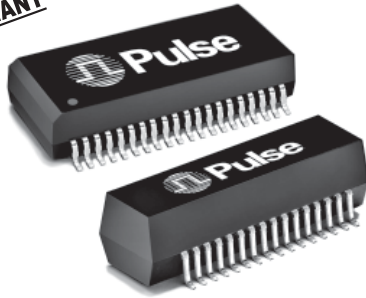

Designed for Quad Port T1/E1 Applications



- RoHS peak reflow temperature rating: 245°C
- For Quad Port T1/E1 applications
- Meets high-performance EMI reduction required for multiplexers, channel routers and ISP servers
- Common mode attenuation from 100 kHz to 500 MHz

## Electrical Specifications @ 25°C — Operating Temperature -40°C to +85°C

RoHS-6 Compliant Part Number	Number of Lines	Primary Inductance OCL (μH MIN)	Common Mode Attenuation (dB TYP)								DCR (Ω MAX)
			100 kHz	1 MHz	10 MHz	30 MHz	50 MHz	100 MHz	300 MHz	500 MHz	
T8008NL	16	47	13	27	40	44	42	36	26	15	0.40
T8132NL	16	47	13	29	43	44	42	35	24	15	0.40

NOTE: When ordering Tape & Reel packaging, add a "T" suffix to the part number (ex:T8008NLT).

## Mechanical

## Schematic

### T8008NL

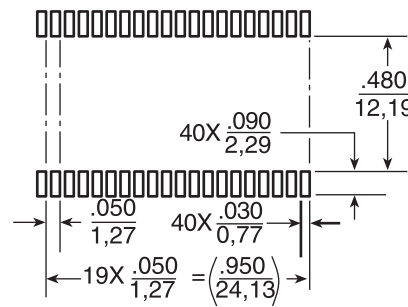
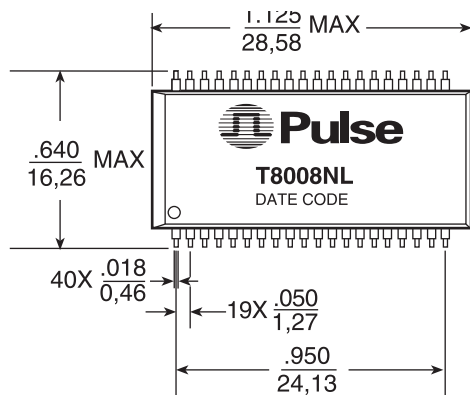

SUGGESTED PAD LAYOUT

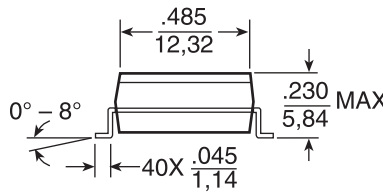
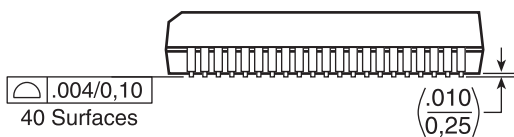
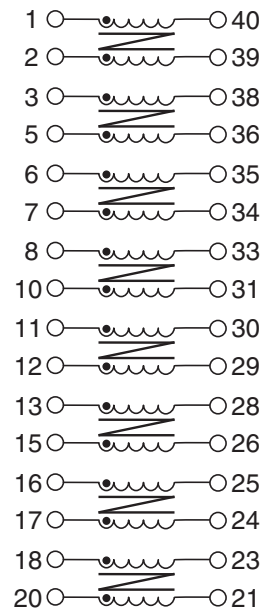

Weight ..... 4.0 grams  
Tape & Reel ..... 250/reel  
Tube ..... 15/tube

Dimensions:  $\frac{\text{Inches}}{\text{mm}}$   
Unless otherwise specified, all tolerances are  $\pm \frac{.010}{0,25}$

# 8x2 LINE COMMON MODECHOKES

## Designed for Quad Port T1/E1 Applications



### Mechanical

### Schematic

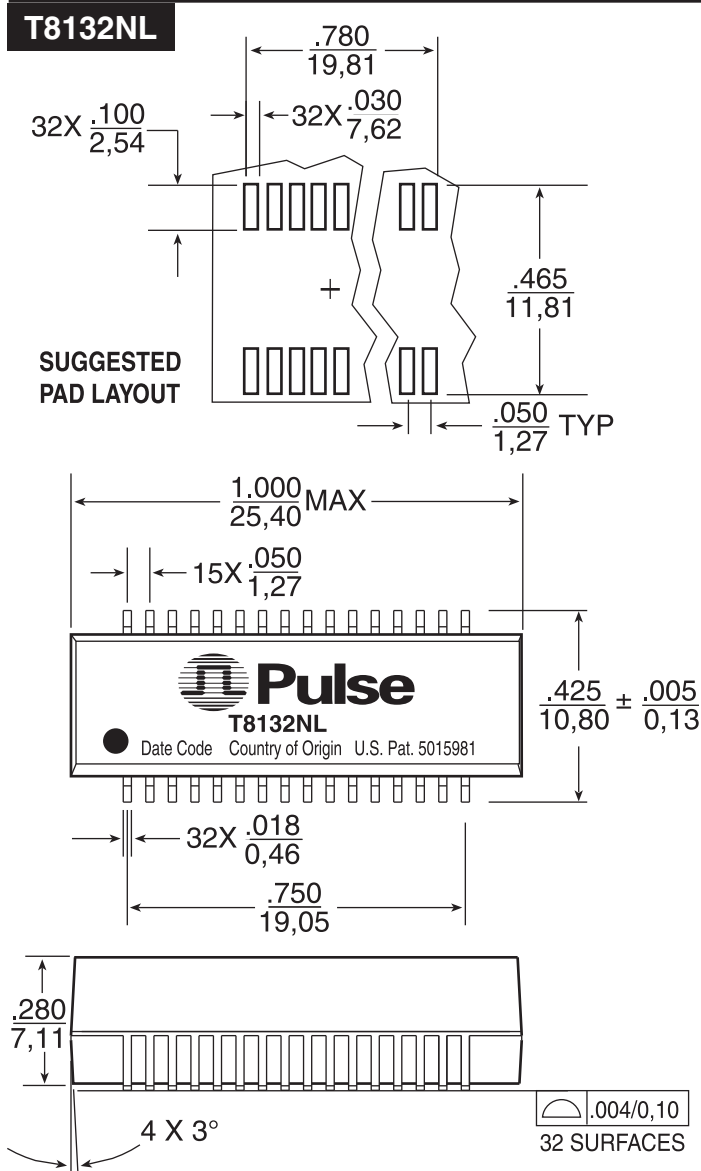

Weight ..... 2.7 grams  
Tape & Reel ..... 200/reel  
Tube ..... 20/tube

Dimensions:  $\frac{\text{Inches}}{\text{mm}}$   
Unless otherwise specified,  
all tolerances are  $\pm \frac{.010}{0.25}$

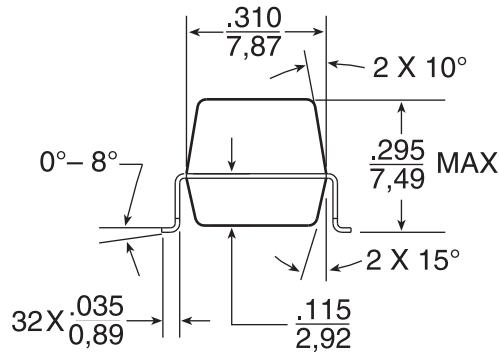
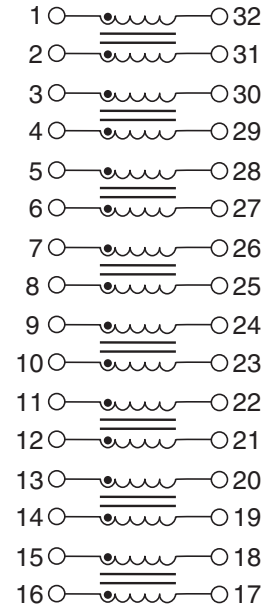

### For More Information:

**Pulse Worldwide Headquarters**  
12220 World Trade Dr.  
San Diego, CA 92128  
U.S.A.

**Pulse Europe**  
Einsteinstrasse 1  
D-71083 Herrenberg  
Germany

**Pulse China Headquarters**  
B402, Shenzhen Academy of  
Aerospace Technology Bldg.  
10th Kejinan Rd.  
High-Tech Zone  
Nanshan District  
Shenzhen, PR China 518057

**Pulse North China**  
Room 1503  
XinYin Building  
No. 888 YiShan Rd.  
Shanghai 200233  
China

**Pulse South Asia**  
135 Joo Seng Rd.  
#03-02  
PM Industrial Bldg.  
Singapore 368363

**Pulse North Asia**  
No. 26, Kao Ching Rd.  
Yang Mei Chen  
Taoyuan Hsien  
Taiwan  
R. O. C.

[www.pulseeng.com](http://www.pulseeng.com)

Tel: 858 674 8100  
Fax: 858 674 8262

Tel: 49 7032 7806 0  
Fax: 49 7032 7806 135

TEL: 86 755 33966678  
FAX: 86 755 33966700

Tel: 86 21 54643211/2  
Fax: 86 21 54643210

TEL: 65 6287 8998  
FAX: 65 6280 0080

Tel: 886 3 4643715  
Fax: 886 3 4641911

Performance warranty of products offered on this data sheet is limited to the parameters specified. Data is subject to change without notice. Other brand and product names mentioned herein may be trademarks or registered trademarks of their respective owners.

© Copyright, 2009, Pulse Engineering, Inc. All rights reserved.

[www.pulseeng.com](http://www.pulseeng.com)

## X-ON Electronics

Largest Supplier of Electrical and Electronic Components

*Click to view similar products for [Common Mode Chokes / Filters](#) category:*

*Click to view products by [Pulse manufacturer](#):*

Other Similar products are found below :

[RGCMF1210900H3T](#) [B82722A2102N001](#) [UAL21V07012500](#) [UAL24VR06500CH](#) [UALSC0220G0000](#) [UALSC058000000](#)  
[UALSC0580J0000](#) [UALSC1520JH000](#) [UALSU10VR15019](#) [UALSU10VR20010](#) [UALSU16VD30030](#) [UALSU16VD40010](#)  
[UALSU9H0305000](#) [UALSU9HF030600](#) [UALSU9HF060300](#) [UALSU9HR050340](#) [UALSU9VD070100](#) [UALSU9VR070170](#) [5701610000](#)  
[CM7060M132R-10](#) [UALW21HS200290](#) [UALW21HS072450](#) [UALSU9VD070400](#) [UALSU9V0701000](#) [UALSU9HR030900](#)  
[UALSU9HF050500](#) [UALSU9H0701000](#) [UALSU9H0208000](#) [UALSU9H0110000](#) [UALSCF25081300](#) [UALSC0305GS000](#)  
[UALSC0120G0000](#) [UAL24VK06450CH](#) [UAL11VL1105000](#) [RN112-3.6-02-0M4](#) [RN114-1.2-02-10M](#) [RN122-0.6-02-47M](#) [RN122-3-02-4M5](#)  
[RN142-1-02-33M](#) [RN214-2.5-02-3M3](#) [RN112-2-02-1M0](#) [RN143-6-02-1M8](#) [RN214-0.8-02-27M](#) [RN242-1.4-02-27M](#) [EXC-X4CH120X](#)  
[DLW5BTM102TQ2L](#) [CMF16-153131](#) [CMF23H-273141](#) [744252510](#) [B82793C0253N201](#)