

SMD Power Inductor CDRH4D28C/LD



Description

- Ferrite drum core construction.
- Magnetically shielded.
- L × W × H: 5.1 × 5.1 × 3.0 mm Max.
- Product weight: 0.21g(Ref.)
- Moisture Sensitivity Level: 1
- RoHS compliance.

Environmental Data

- Operating temperature range: -40°C ~ +105°C (including coil's self temperature rise)
- Storage temperature range: -40°C ~ +105°C
- Solder reflow temperature: 260 °C peak.

Packaging

- Carrier tape and reel packaging
- 12.9" diameter reel
- 2000pcs per reel

Applications

- Ideally used in Mobile phone, PDA, MP3, HDD, DSC/DVC, Note book PC, etc as DC-DC converter inductors.

Dimension - [mm]

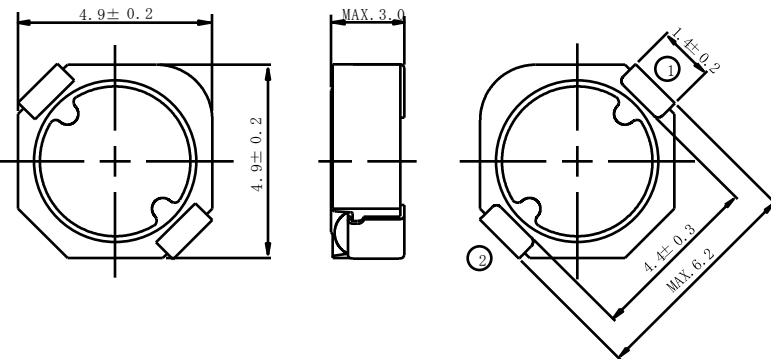

Land pattern and Schematics - [mm]

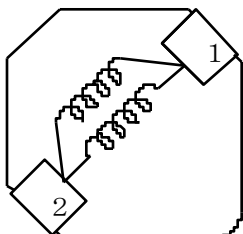
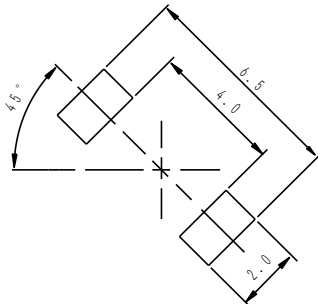

(1.0µH ~ 6.8µH)

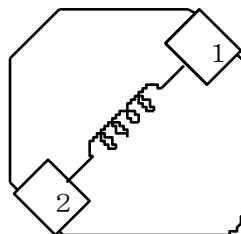

(10µH ~ 100µH)



Electrical Characteristics

Part No.	Stamp	Inductance (μH) [within] ※1	D.C.R (m Ω) Max. (Typ.) (20°C)	Saturation Current (A) ※2	Temperature Rise Current (A) ※3
CDRH4D28CLDNP-1R0PC	A	1.0 \pm 25%	17.5(14)	3.0	4.9
CDRH4D28CLDNP-2R2PC	B	2.2 \pm 25%	23.8(19)	2.0	3.6
CDRH4D28CLDNP-3R3PC	C	3.3 \pm 25%	28.9(23)	1.6	3.2
CDRH4D28CLDNP-4R7PC	D	4.7 \pm 25%	36.3(29)	1.5	2.9
CDRH4D28CLDNP-6R8PC	E	6.8 \pm 25%	48.8(39)	1.2	2.4
CDRH4D28CLDNP-100PC	F	10 \pm 25%	67.5(54)	0.90	1.8
CDRH4D28CLDNP-150PC	G	15 \pm 25%	93.4(75)	0.81	1.6
CDRH4D28CLDNP-220PC	H	22 \pm 25%	140(112)	0.65	1.25
CDRH4D28CLDNP-330PC	I	33 \pm 25%	223(179)	0.55	0.92
CDRH4D28CLDNP-470PC	J	47 \pm 25%	272(218)	0.43	0.86
CDRH4D28CLDNP-680PC	K	68 \pm 25%	366(293)	0.36	0.72
CDRH4D28CLDNP-101PC	L	100 \pm 25%	520(416)	0.30	0.61

※1. Inductance measuring condition: at 100kHz.

※2. Saturation current: The value of D.C. current when the inductance decreases to 65% of it's nominal value.

※3. Temperature rise current: The value of D.C. current when the temperature rise is $\Delta t = 40^\circ\text{C}$ ($T_a = 20^\circ\text{C}$).

SMD Power Inductor CDRH4D28C/LD

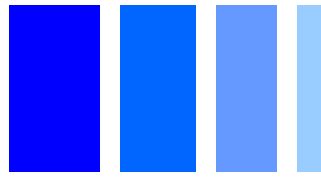

Saturation Current & Temperature Rise Graph

— L (20°C) — L (100°C) — ΔT

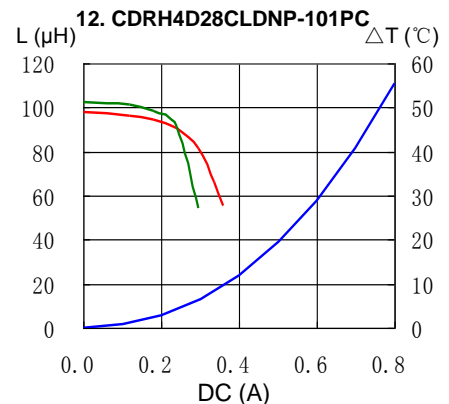
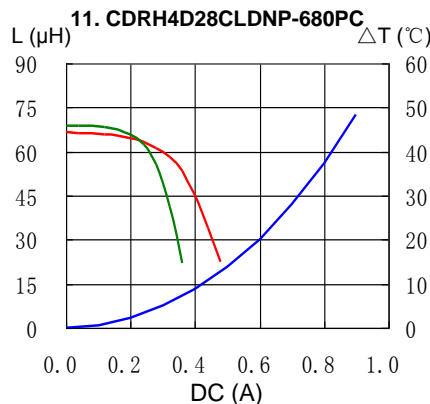
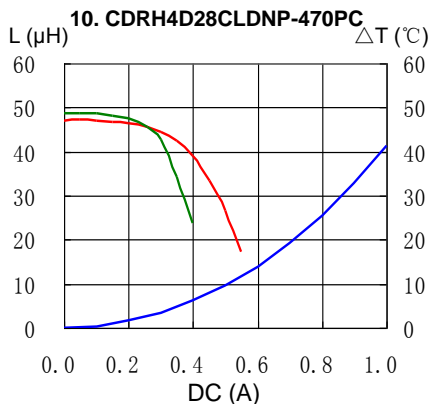
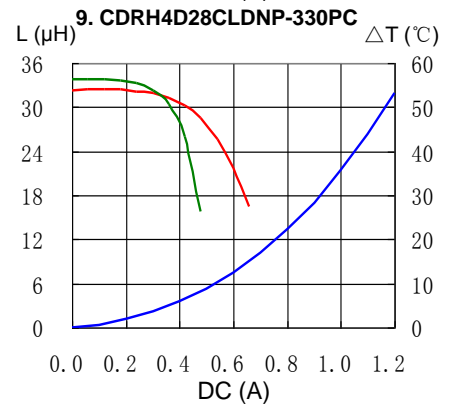
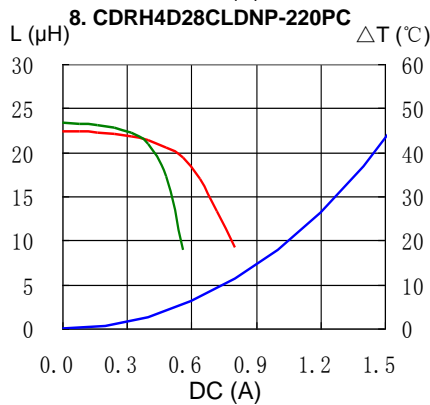
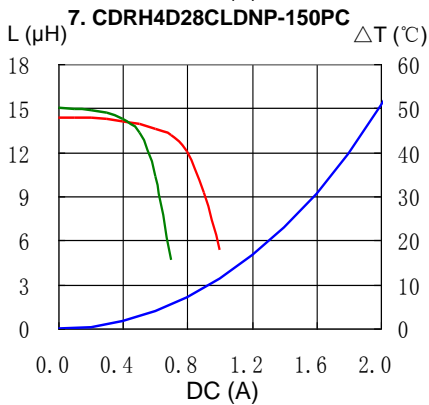
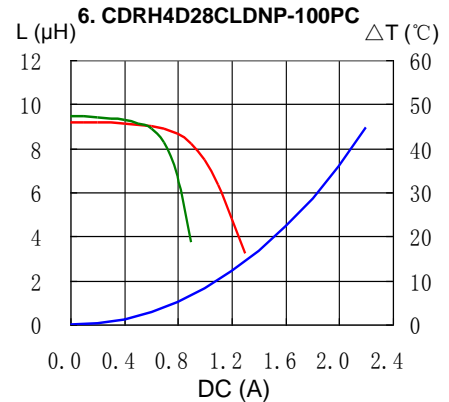
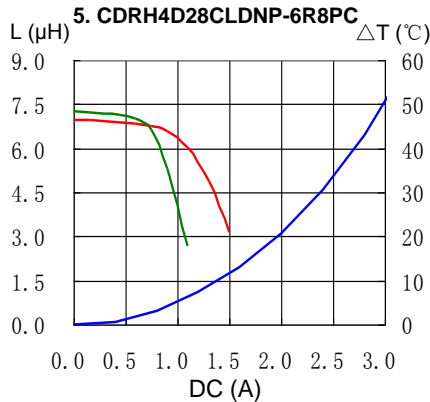
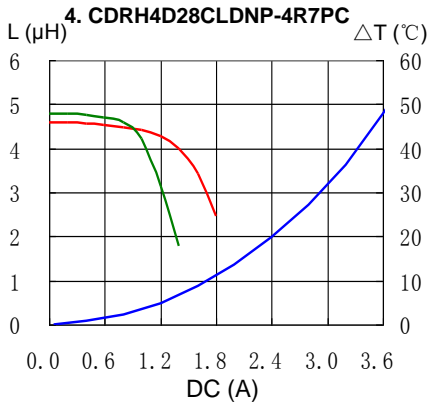
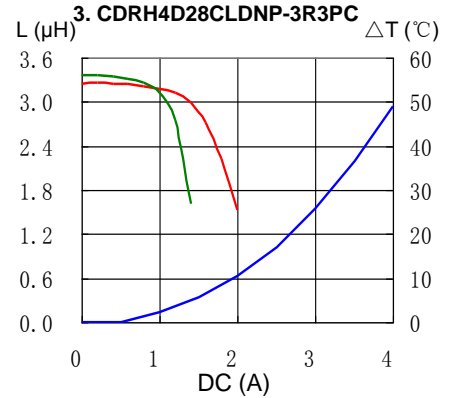
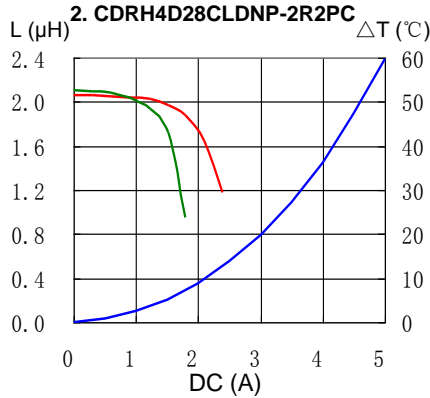
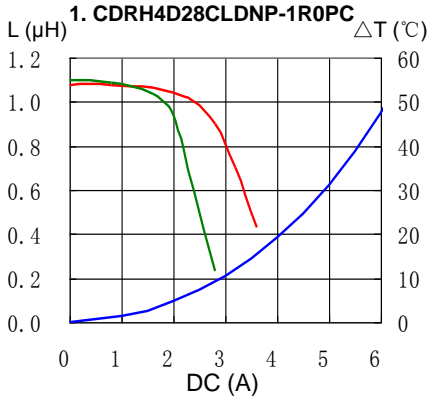

SMD Power Inductor CDRH4D28C/LD

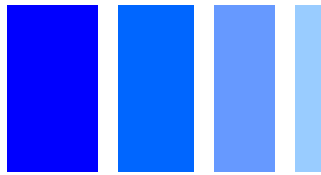

Solder Reflow Condition

Heat Endurance

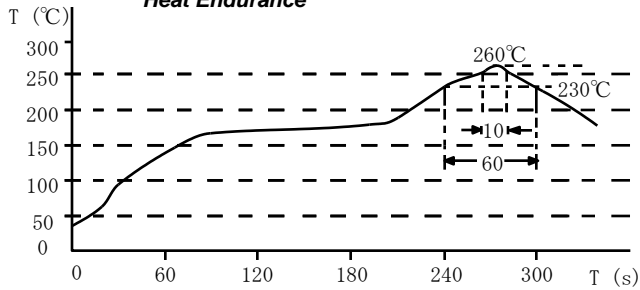

Temperature Chart

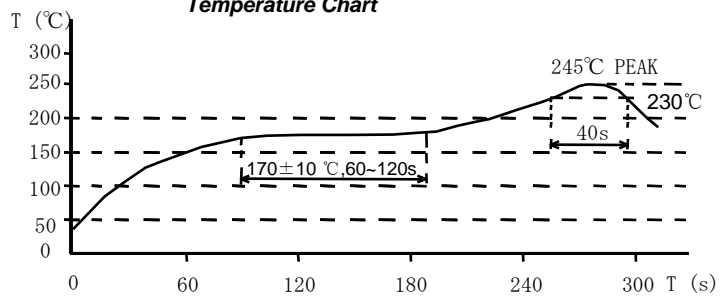

Please refer to the sales offices on our website - <http://www.sumida.com>

Hong Kong

Tel.+852-2880-6781
FAX.+852-2565-9600
sales@hk.sumida.com

Saitama(Japan)

Tel.+81-48-691-7300
FAX.+81-48-691-7340
sales@jp.sumida.com

Chicago

Tel.+1-847-545-6700
FAX. +1-847-545-6720
sales@us.sumida.com

Shanghai

Tel.+86-21-5836-3299
FAX.+86-21-5836-3266
shanghai.sales@cn.sumida.com

Seoul

Tel.+82-2-6237-0777
FAX.+82-2-6237-0778
sales@kr.sumida.com

Obernzell

Tel.+49-8591-937-0
FAX. +49-8591-937-103
contact@eu.sumida.com

Shenzhen

Tel.+86-755-8291-0228
FAX.+86-755-8291-0338
shenzhen.sales@cn.sumida.com

Singapore

Tel.+65-6296-3388
FAX.+65-6841-4426
sales@sg.sumida.com

Neumarkt

Tel.+49-9181-4509-110
FAX. +49-9181-4509-310
infocomp@eu.sumida.com

Taipei

Tel.+886-2-8751-2737
FAX.+886-2-8751-2738
sales@tw.sumida.com

San Jose

Tel.+1-408-321-9660
FAX.+1-408-321-9308
sales@us.sumida.com

X-ON Electronics

Largest Supplier of Electrical and Electronic Components

Click to view similar products for [Fixed Inductors](#) category:

Click to view products by [Sumida](#) manufacturer:

Other Similar products are found below :

[MLZ1608M6R8WTD25](#) [MLZ1608N6R8LT000](#) [MLZ1608N3R3LTD25](#) [MLZ1608N3R3LT000](#) [MLZ1608N150LT000](#)

[MLZ1608M150WTD25](#) [MLZ1608M3R3WTD25](#) [MLZ1608M3R3WT000](#) [MLZ1608M150WT000](#) [MLZ1608A1R5WT000](#)

[MLZ1608N1R5LT000](#) [B82432C1333K000](#) [PCMB053T-1R0MS](#) [PCMB053T-1R5MS](#) [PCMB104T-1R5MS](#) [CR32NP-100KC](#) [CR32NP-](#)

[151KC](#) [CR32NP-180KC](#) [CR32NP-181KC](#) [CR32NP-1R5MC](#) [CR32NP-390KC](#) [CR32NP-3R9MC](#) [CR32NP-680KC](#) [CR32NP-820KC](#)

[CR32NP-8R2MC](#) [CR43NP-390KC](#) [CR43NP-560KC](#) [CR43NP-680KC](#) [CR54NP-181KC](#) [CR54NP-470LC](#) [CR54NP-820KC](#) [CR54NP-8R5MC](#)

[MGDQ4-00004-P](#) [MGDU1-00016-P](#) [MHL1ECTTP18NJ](#) [MHL1JCTTD12NJ](#) [PE-51506NL](#) [PE-53601NL](#) [PE-53630NL](#) [PE-53824SNLT](#) [PE-](#)

[62892NL](#) [PE-92100NL](#) [PG0434.801NLT](#) [PG0936.113NLT](#) [PM06-2N7](#) [PM06-39NJ](#) [HC2LP-R47-R](#) [HC2-R47-R](#) [HC3-2R2-R](#) [HC8-1R2-R](#)