

Please read this notice before using the TAIYO YUDEN products.

REMINDERS

- Product information in this catalog is as of October 2017. All of the contents specified herein are subject to change without notice due to technical improvements, etc. Therefore, please check for the latest information carefully before practical application or use of our products.

Please note that TAIYO YUDEN shall not be in any way responsible for any damages and defects in products or equipment incorporating our products, which are caused under the conditions other than those specified in this catalog or individual product specification sheets.

- Please contact TAIYO YUDEN for further details of product specifications as the individual product specification sheets are available.
- Please conduct validation and verification of our products in actual condition of mounting and operating environment before using our products.
- The products listed in this catalog are intended for use in general electronic equipment (e.g., AV equipment, OA equipment, home electric appliances, office equipment, information and communication equipment including, without limitation, mobile phone, and PC) and medical equipment classified as Class I or II by IMDRF. Please be sure to contact TAIYO YUDEN for further information before using the products for any equipment which may directly cause loss of human life or bodily injury (e.g., transportation equipment including, without limitation, automotive powertrain control system, train control system, and ship control system, traffic signal equipment, disaster prevention equipment, medical equipment classified as Class III by IMDRF, highly public information network equipment including, without limitation, telephone exchange, and base station).

Please do not incorporate our products into any equipment requiring high levels of safety and/or reliability (e.g., aerospace equipment, aviation equipment*, medical equipment classified as Class IV by IMDRF, nuclear control equipment, undersea equipment, military equipment).

*Note: There is a possibility that our products can be used only for aviation equipment that does not directly affect the safe operation of aircraft (e.g., in-flight entertainment, cabin light, electric seat, cooking equipment) if such use meets requirements specified separately by TAIYO YUDEN. Please be sure to contact TAIYO YUDEN for further information before using our products for such aviation equipment.

When our products are used even for high safety and/or reliability-required devices or circuits of general electronic equipment, it is strongly recommended to perform a thorough safety evaluation prior to use of our products and to install a protection circuit as necessary.

Please note that unless you obtain prior written consent of TAIYO YUDEN, TAIYO YUDEN shall not be in any way responsible for any damages incurred by you or third parties arising from use of the products listed in this catalog for any equipment requiring inquiry to TAIYO YUDEN or prohibited for use by TAIYO YUDEN as described above.

- Information contained in this catalog is intended to convey examples of typical performances and/or applications of our products and is not intended to make any warranty with respect to the intellectual property rights or any other related rights of TAIYO YUDEN or any third parties nor grant any license under such rights.
- Please note that the scope of warranty for our products is limited to the delivered our products themselves and TAIYO YUDEN shall not be in any way responsible for any damages resulting from a fault or defect in our products. Notwithstanding the foregoing, if there is a written agreement (e.g., supply and purchase agreement, quality assurance agreement) signed by TAIYO YUDEN and your company, TAIYO YUDEN will warrant our products in accordance with such agreement.
- The contents of this catalog are applicable to our products which are purchased from our sales offices or authorized distributors (hereinafter "TAIYO YUDEN's official sales channel"). Please note that the contents of this catalog are not applicable to our products purchased from any seller other than TAIYO YUDEN's official sales channel.
- Caution for Export
Some of our products listed in this catalog may require specific procedures for export according to "U.S. Export Administration Regulations", "Foreign Exchange and Foreign Trade Control Law" of Japan, and other applicable regulations. Should you have any questions on this matter, please contact our sales staff.

MULTILAYER CERAMIC CAPACITORS

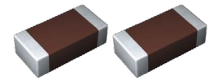

WAVE

REFLOW

PARTS NUMBER

J	M	K	3	1	6	△	B	J	1	0	6	M	L	-	T	△
①	②	③	④	⑤	⑥	⑦	⑧	⑨	⑩	⑪	⑫					

△=Blank space

① Rated voltage

Code	Rated voltage [VDC]
P	2.5
A	4
J	6.3
L	10
E	16
T	25
G	35
U	50
H	100
Q	250
S	630

③ End termination

Code	End termination
K	Plated
S	Cu Internal Electrodes

② Series name

Code	Series name
M	Multilayer ceramic capacitor
V	Multilayer ceramic capacitor for high frequency
W	LW reverse type multilayer capacitor

④ Dimension (L × W)

Type	Dimensions (L × W) [mm]	EIA (inch)
021	0.25 × 0.125	008004
042	0.4 × 0.2	01005
063	0.6 × 0.3	0201
105	1.0 × 0.5	0402
	0.52 × 1.0 ※	0204
107	1.6 × 0.8	0603
	0.8 × 1.6 ※	0306
212	2.0 × 1.25	0805
	1.25 × 2.0 ※	0508
316	3.2 × 1.6	1206
325	3.2 × 2.5	1210
432	4.5 × 3.2	1812

Note : ※LW reverse type (□WK) only

⑤ Dimension tolerance

Code	Type	L [mm]	W [mm]	T [mm]
△	ALL	Standard	Standard	Standard
A	063	0.6±0.05	0.3±0.05	0.3±0.05
	105	1.0±0.10	0.5±0.10	0.5±0.10
	107	1.6+0.15/-0.05	0.8+0.15/-0.05	0.8+0.15/-0.05
	212	2.0+0.15/-0.05	1.25+0.15/-0.05	0.45±0.05
				0.85±0.10
				1.25+0.15/-0.05
316	3.2±0.20	1.6±0.20	0.85±0.10	
325	3.2±0.30	2.5±0.30	1.6±0.20	
B	063	0.6±0.09	0.3±0.09	2.5±0.30
	105	1.0+0.15/-0.05	0.5+0.15/-0.05	0.3±0.09
				0.5+0.15/-0.05
	107	1.6+0.20/-0	0.8+0.20/-0	0.45±0.05
	212	2.0+0.20/-0	1.25+0.20/-0	0.8+0.20/-0
0.45±0.05				
316	3.2±0.30	1.6±0.30	0.85±0.10	
C	105	1.0+0.20/-0	0.5+0.20/-0	1.25+0.20/-0
				1.6±0.30

Note: cf. STANDARD EXTERNAL DIMENSIONS

△= Blank space

⑥ Temperature characteristics code

■ High dielectric type (Excluding Super low distortion multilayer ceramic capacitor)

Code	Applicable standard	Temperature range [°C]	Ref. Temp. [°C]	Capacitance change	Capacitance tolerance	Tolerance code
BJ	JIS	B	-25~+85	20	±10%	K
						M
	EIA	X5R	-55~+85	25	±15%	K
B7	EIA	X7R	-55~+125	25	±15%	M
						K
C6	EIA	X6S	-55~+105	25	±22%	K
						M
C7	EIA	X7S	-55~+125	25	±22%	K
						M
LD(※)	EIA	X5R	-55~+85	25	±15%	K
						M

Note : ※LD Low distortion high value multilayer ceramic capacitor

△= Blank space

▶ This catalog contains the typical specification only due to the limitation of space. When you consider the purchase of our products, please check our product specification sheets. For details of each product (characteristics graph, reliability information, precautions for use, and so on), see our website (<http://www.ty-top.com/>).

■ Temperature compensating type

Code	Applicable standard		Temperature range [°C]	Ref. Temp. [°C]	Capacitance change	Capacitance tolerance	Tolerance code
CG	EIA	C0G	-55 ~ +125	25	0 ± 30ppm/°C	±0.05pF	A
						±0.1pF	B
						±0.25pF	C
						±0.5pF	D
						±5%	J
UJ	JIS	UJ	-55 ~ +125	20	-750 ± 120ppm/°C	±0.25pF	C
						±0.5pF	D
	EIA	U2J		25		±5%	J
UK	JIS	UK	-55 ~ +125	20	-750 ± 250ppm/°C	±0.25pF	C
	EIA	U2K	-55 ~ +125	25			
SL	JIS	SL	-55 ~ +125	20	+350 ~ -1000ppm/°C	±5%	J

⑥ Series code

• Super low distortion multilayer ceramic capacitor

Code	Series code
SD	Standard

• Medium-High Voltage Multilayer Ceramic Capacitor

Code	Series code
SD	Standard

⑦ Nominal capacitance

Code (example)	Nominal capacitance
0R5	0.5pF
010	1pF
100	10pF
101	100pF
102	1,000pF
103	10,000pF
104	0.1 μF
105	1.0 μF
106	10 μF
107	100 μF

Note : R=Decimal point

⑧ Capacitance tolerance

Code	Capacitance tolerance
A	±0.05pF
B	±0.1pF
C	±0.25pF
D	±0.5pF
F	±1pF
G	±2%
J	±5%
K	±10%
M	±20%
Z	+80/-20%

⑨ Thickness

Code	Thickness [mm]
K	0.125
H	0.13
E	0.18
C	0.2
D	
P	0.3
T	
K	0.45 (107type or more)
V	0.5
W	
A	0.8
D	0.85 (212type or more)
F	1.15
G	1.25
L	1.6
N	1.9
Y	2.0 max
M	2.5

⑩ Special code

Code	Special code
-	Standard

⑪ Packaging

Code	Packaging
F	φ178mm Taping (2mm pitch)
T	φ178mm Taping (4mm pitch)
P	φ178mm Taping (4mm pitch, 1000 pcs/reel) 325 type (Thickness code M)
R	φ178mm Taping (2mm pitch) 105type only (Thickness code E,H)
W	φ178mm Taping (1mm pitch) 021/042type only

⑫ Internal code

Code	Internal code
△	Standard

► This catalog contains the typical specification only due to the limitation of space. When you consider the purchase of our products, please check our product specification sheets. For details of each product (characteristics graph, reliability information, precautions for use, and so on), see our website (<http://www.ty-top.com/>).

■ STANDARD EXTERNAL DIMENSIONS

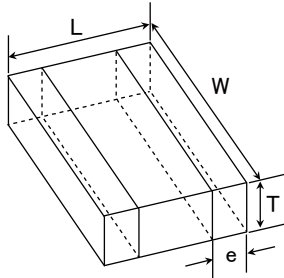
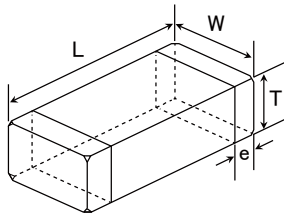

※ LW reverse type

Type(EIA)	Dimension [mm]					
	L	W	T	*1	e	
□MK021(008004)	0.25±0.013	0.125±0.013	0.125±0.013	K	0.0675±0.0275	
□VS021(008004)	0.25±0.013	0.125±0.013	0.125±0.013	K	0.0675±0.0275	
□MK042(01005)	0.4±0.02	0.2±0.02	0.2±0.02	C	0.1±0.03	
□VS042(01005)				D		
□MK063(0201)	0.6±0.03	0.3±0.03	0.3±0.03	P	0.15±0.05	
□MK105(0402)				T		
□MK105(0402)	1.0±0.05	0.5±0.05	0.5±0.05	0.13±0.02	H	0.25±0.10
				0.18±0.02	E	
				0.2±0.02	C	
				0.3±0.03	P	
				0.5±0.05	V	
□VK105(0402)	1.0±0.05	0.5±0.05	0.5±0.05	W	0.25±0.10	
□WK105(0204)※	0.52±0.05	1.0±0.05	0.3±0.05	P	0.18±0.08	
□MK107(0603)	1.6±0.10	0.8±0.10	0.8±0.10	0.45±0.05	K	0.35±0.25
				0.8±0.10	A	
□WK107(0306)※	0.8±0.10	1.6±0.10	0.5±0.05	V	0.25±0.15	
□MK212(0805)	2.0±0.10	1.25±0.10	1.25±0.10	0.45±0.05	K	0.5±0.25
				0.85±0.10	D	
				1.25±0.10	G	
□WK212(0508)※	1.25±0.15	2.0±0.15	0.85±0.10	D	0.3±0.2	
□MK316(1206)	3.2±0.15	1.6±0.15	1.6±0.15	0.85±0.10	D	0.5+0.35/-0.25
				1.15±0.10	F	
				1.6±0.20	L	
□MK325(1210)	3.2±0.30	2.5±0.20	2.5±0.20	0.85±0.10	D	0.6±0.3
				1.15±0.10	F	
				1.9±0.20	N	
				1.9+0.1/-0.2	Y	
□MK432(1812)	4.5±0.40	3.2±0.30	2.5±0.20	M	0.9±0.6	

Note : ※. LW reverse type, *1.Thickness code

■ STANDARD QUANTITY

Type	EIA (inch)	Dimension		Standard quantity [pcs]			
		[mm]	Code	Paper tape	Embossed tape		
021	008004	0.125	K	—	50000		
042	01005	0.2	C	—	40000		
			D				
063	0201	0.3	P	15000	—		
			T				
105	0402	0.13	H	—	20000		
			E	—	15000		
			C	20000	—		
			P	15000	—		
			V	10000	—		
	W	—					
	0204 ※	0.30	P	—	—		
107	0603	0.45	K	4000	—		
			A				
	0306 ※	0.50	V	—	4000		
212	0805	0.85	K	4000	—		
			D				
	0508 ※	1.25	G	—	3000		
316	1206	0.85	D	4000	—		
			F			—	3000
			L			—	2000
325	1210	2.0 max	D	—	2000		
			F				
			N				
			Y				
432	1812	2.5	M	—	1000		
			M	—	500		

Note : ※.LW Reverse type(□WK)

▶ This catalog contains the typical specification only due to the limitation of space. When you consider the purchase of our products, please check our product specification sheets. For details of each product (characteristics graph, reliability information, precautions for use, and so on), see our website (<http://www.ty-top.com/>).

PARTS NUMBER

- All the Multilayer Ceramic Capacitors of the catalog lineup are RoHS Compliant.
- Capacitance tolerance code is applied to □ of part number.

Note)

*1 We may provide X7R/X7S for some items according to the individual specification.

*2 The exchange of individual specification is necessary depending on the application and circuit condition. Please contact TAIYO YUDEN sales channels.

*3 The size standard should look at ④Dimension, ⑤Dimension tolerance, and ⑨Thickness, and STANDARD EXTERNAL DIMENSIONS.

Multilayer Ceramic Capacitors (High dielectric type)

021TYPE

【Temperature Characteristic BJ : X5R】 0.125mm thickness (K)

Part number 1	Part number 2	Rated voltage [V]	Temperature characteristics	Capacitance [F]	Capacitance tolerance [%]	tan δ [%]	HTLT	Thickness*3 [mm]	Soldering R:Reflow W:Wave
							Rated voltage x %		
EMK021 BJ221□K-W		16	X5R	220 p	±10, ±20	10	150	0.125±0.013	R
EMK021 BJ471□K-W			X5R	470 p	±10, ±20	10	150		
EMK021 BJ102□K-W			X5R	1000 p	±10, ±20	10	150		
JMK021 BJ222□K-W		6.3	X5R	2200 p	±10, ±20	10	150	0.125±0.013	R
JMK021 BJ472□K-W			X5R	4700 p	±10, ±20	10	150		
JMK021 BJ103□K-W			X5R	0.01 μ	±10, ±20	10	150		
AMK021 BJ223MK-W		4	X5R	0.022 μ	±20	10	150	0.125±0.013	R

042TYPE

【Temperature Characteristic BJ : B/X5R】 0.2mm thickness (C)

Part number 1	Part number 2	Rated voltage [V]	Temperature characteristics	Capacitance [F]	Capacitance tolerance [%]	tan δ [%]	HTLT	Thickness*3 [mm]	Soldering R:Reflow W:Wave
							Rated voltage x %		
EMK042 BJ101□C-W		16	B X5R	100 p	±10, ±20	5	200	0.2±0.02	R
EMK042 BJ151□C-W			B X5R	150 p	±10, ±20	5	200		
EMK042 BJ221□C-W			B X5R	220 p	±10, ±20	5	200		
EMK042 BJ331□C-W			B X5R	330 p	±10, ±20	5	200		
EMK042 BJ471□C-W			B X5R	470 p	±10, ±20	5	200		
EMK042 BJ681□C-W			B X5R	680 p	±10, ±20	5	200		
EMK042 BJ102□C-W			B X5R	1000 p	±10, ±20	5	200		
EMK042 BJ152□C-W			X5R	1500 p	±10, ±20	10	150		
EMK042 BJ222□C-W			X5R	2200 p	±10, ±20	10	150		
EMK042 BJ332□C-W			X5R	3300 p	±10, ±20	10	150		
EMK042 BJ472□C-W			X5R	4700 p	±10, ±20	10	150		
EMK042 BJ682□C-W			X5R	6800 p	±10, ±20	10	150		
EMK042 BJ103□C-W			X5R	0.01 μ	±10, ±20	10	150		
LMK042 BJ101□C-W			B X5R ^{*1}	100 p	±10, ±20	5	200		
LMK042 BJ151□C-W			B X5R ^{*1}	150 p	±10, ±20	5	200		
LMK042 BJ221□C-W			B X5R ^{*1}	220 p	±10, ±20	5	200		
LMK042 BJ331□C-W		B X5R ^{*1}	330 p	±10, ±20	5	200			
LMK042 BJ471□C-W		B X5R ^{*1}	470 p	±10, ±20	5	200			
LMK042 BJ681□C-W		B X5R ^{*1}	680 p	±10, ±20	5	200			
LMK042 BJ102□C-W		B X5R ^{*1}	1000 p	±10, ±20	5	200			
LMK042 BJ152□C-W		X5R	1500 p	±10, ±20	10	150			
LMK042 BJ222□C-W		X5R	2200 p	±10, ±20	10	150			
LMK042 BJ332□C-W		X5R	3300 p	±10, ±20	10	150			
LMK042 BJ472□C-W		X5R	4700 p	±10, ±20	10	150			
LMK042 BJ682□C-W		X5R	6800 p	±10, ±20	10	150			
LMK042 BJ103□C-W		X5R	0.01 μ	±10, ±20	10	150			
JMK042 BJ152□C-W		6.3	B X5R ^{*1}	1500 p	±10, ±20	10	150	0.2±0.02	R
JMK042 BJ222□C-W			B X5R ^{*1}	2200 p	±10, ±20	10	150		
JMK042 BJ332□C-W			B X5R ^{*1}	3300 p	±10, ±20	10	150		
JMK042 BJ472□C-W			B X5R ^{*1}	4700 p	±10, ±20	10	150		
JMK042 BJ682□C-W			B X5R ^{*1}	6800 p	±10, ±20	10	150		
JMK042 BJ103□C-W			B X5R ^{*1}	0.01 μ	±10, ±20	10	150		
JMK042 BJ223□C-W			X5R	0.022 μ	±10, ±20	10	150		
JMK042 BJ473□C-W			X5R	0.047 μ	±10, ±20	10	150		
JMK042 BJ104□C-W			X5R	0.1 μ	±10, ±20	10	150		
AMK042 BJ473□C-W			X5R	0.047 μ	±10, ±20	10	150		
AMK042 BJ104□C-W			X5R	0.1 μ	±10, ±20	10	150		

【Temperature Characteristic B7 : X7R】 0.2mm thickness (C)

Part number 1	Part number 2	Rated voltage [V]	Temperature characteristics	Capacitance [F]	Capacitance tolerance [%]	tan δ [%]	HTLT	Thickness*3 [mm]	Soldering R:Reflow W:Wave
							Rated voltage x %		
EMK042 B7101□C-W		16	X7R	100 p	±10, ±20	5	200	0.2±0.02	R
EMK042 B7151□C-W			X7R	150 p	±10, ±20	5	200		
EMK042 B7221□C-W			X7R	220 p	±10, ±20	5	200		
EMK042 B7331□C-W			X7R	330 p	±10, ±20	5	200		
EMK042 B7471□C-W			X7R	470 p	±10, ±20	5	200		
EMK042 B7681□C-W			X7R	680 p	±10, ±20	5	200		
EMK042 B7102□C-W			X7R	1000 p	±10, ±20	5	200		
LMK042 B7101□C-W			X7R	100 p	±10, ±20	5	200		
LMK042 B7151□C-W			X7R	150 p	±10, ±20	5	200		
LMK042 B7221□C-W			X7R	220 p	±10, ±20	5	200		
LMK042 B7331□C-W			X7R	330 p	±10, ±20	5	200		
LMK042 B7471□C-W			X7R	470 p	±10, ±20	5	200		
LMK042 B7681□C-W		X7R	680 p	±10, ±20	5	200			
LMK042 B7102□C-W		X7R	1000 p	±10, ±20	5	200			

▶ This catalog contains the typical specification only due to the limitation of space. When you consider the purchase of our products, please check our product specification sheets. For details of each product (characteristics graph, reliability information, precautions for use, and so on), see our website (<http://www.ty-top.com/>).

063TYPE

[Temperature Characteristic BJ : B/X5R] 0.3mm thickness (P)

Part number 1	Part number 2	Rated voltage [V]	Temperature characteristics		Capacitance [F]	Capacitance tolerance [%]	tan δ [%]	HTLT		Thickness ^{*3} [mm]	Soldering R:Reflow W:Wave
								Rated voltage x %			
UMK063 BJ101□P-F		50	B	X5R ⁺¹	100 p	±10, ±20	3.5	200	0.3±0.03	R	
UMK063 BJ151□P-F			B	X5R ⁺¹	150 p	±10, ±20	3.5	200	0.3±0.03	R	
UMK063 BJ221□P-F			B	X5R ⁺¹	220 p	±10, ±20	3.5	200	0.3±0.03	R	
UMK063 BJ331□P-F			B	X5R ⁺¹	330 p	±10, ±20	3.5	200	0.3±0.03	R	
UMK063 BJ471□P-F			B	X5R ⁺¹	470 p	±10, ±20	3.5	200	0.3±0.03	R	
UMK063 BJ681□P-F			B	X5R ⁺¹	680 p	±10, ±20	3.5	200	0.3±0.03	R	
UMK063 BJ102□P-F			B	X5R ⁺¹	1000 p	±10, ±20	3.5	200	0.3±0.03	R	
UMK063 BJ152□P-F			B	X5R	1500 p	±10, ±20	5	200	0.3±0.03	R	
UMK063 BJ222□P-F			B	X5R	2200 p	±10, ±20	5	200	0.3±0.03	R	
UMK063 BJ332□P-F			B	X5R	3300 p	±10, ±20	5	200	0.3±0.03	R	
UMK063 BJ472□P-F			B	X5R	4700 p	±10, ±20	5	200	0.3±0.03	R	
UMK063 BJ682□P-F			B	X5R	6800 p	±10, ±20	5	200	0.3±0.03	R	
UMK063 BJ103□P-F			B	X5R	0.01 μ	±10, ±20	5	200	0.3±0.03	R	
GMK063 BJ104□P-F			35	X5R	0.1 μ	±10, ±20	10	150	0.3±0.03	R	
TMK063 BJ152□P-F			25	B	X5R	1500 p	±10, ±20	5	200	0.3±0.03	R
TMK063 BJ222□P-F				B	X5R	2200 p	±10, ±20	5	200	0.3±0.03	R
TMK063 BJ332□P-F		B		X5R	3300 p	±10, ±20	5	200	0.3±0.03	R	
TMK063 BJ472□P-F		B		X5R	4700 p	±10, ±20	5	200	0.3±0.03	R	
TMK063 BJ682□P-F		B		X5R	6800 p	±10, ±20	5	200	0.3±0.03	R	
TMK063 BJ103□P-F		B		X5R	0.01 μ	±10, ±20	5	200	0.3±0.03	R	
TMK063 BJ223□P-F		B		X5R	0.022 μ	±10, ±20	7.5	200	0.3±0.03	R	
TMK063ABJ104□P-F		X5R		0.1 μ	±10, ±20	10	150	0.3±0.05	R		
EMK063 BJ152□P-F		16	B	X5R ⁺¹	1500 p	±10, ±20	5	200	0.3±0.03	R	
EMK063 BJ222□P-F			B	X5R ⁺¹	2200 p	±10, ±20	5	200	0.3±0.03	R	
EMK063 BJ332□P-F			B	X5R ⁺¹	3300 p	±10, ±20	5	200	0.3±0.03	R	
EMK063 BJ472□P-F			B	X5R ⁺¹	4700 p	±10, ±20	5	200	0.3±0.03	R	
EMK063 BJ682□P-F			B	X5R ⁺¹	6800 p	±10, ±20	5	200	0.3±0.03	R	
EMK063 BJ103□P-F			B	X5R ⁺¹	0.01 μ	±10, ±20	5	200	0.3±0.03	R	
EMK063 BJ223□P-F			B	X5R	0.022 μ	±10, ±20	7.5	200	0.3±0.03	R	
EMK063 BJ333□P-F			X5R	0.033 μ	±10, ±20	7.5	150	0.3±0.03	R		
EMK063 BJ473□P-F			X5R	0.047 μ	±10, ±20	7.5	150	0.3±0.03	R		
EMK063 BJ683□P-F			X5R	0.068 μ	±10, ±20	10	150	0.3±0.03	R		
EMK063 BJ104□P-F			X5R	0.1 μ	±10, ±20	10	150	0.3±0.03	R		
EMK063 BJ224□P-F			X5R	0.22 μ	±10, ±20	10	150	0.3±0.03	R		
EMK063BBJ474□PLF			X5R	0.47 μ	±10, ±20	10	150	0.3±0.09	R		
LMK063 BJ223□P-F			10	B	X5R	0.022 μ	±10, ±20	7.5	150	0.3±0.03	R
LMK063 BJ333□P-F				X5R	0.033 μ	±10, ±20	7.5	150	0.3±0.03	R	
LMK063 BJ473□P-F				X5R	0.047 μ	±10, ±20	7.5	150	0.3±0.03	R	
LMK063 BJ683□P-F		X5R		0.068 μ	±10, ±20	10	150	0.3±0.03	R		
LMK063 BJ104□P-F		X5R		0.1 μ	±10, ±20	10	150	0.3±0.03	R		
LMK063 BJ224□P-F		X5R		0.22 μ	±10, ±20	10	150	0.3±0.03	R		
LMK063BBJ474□PLF		X5R		0.47 μ	±10, ±20	10	150	0.3±0.09	R		
LMK063BBJ105MP-LF		X5R		1 μ	±20	10	150	0.3±0.09	R		
JMK063 BJ223□P-F		6.3	B	X5R	0.022 μ	±10, ±20	7.5	200	0.3±0.03	R	
JMK063 BJ333□P-F			X5R	0.033 μ	±10, ±20	7.5	150	0.3±0.03	R		
JMK063 BJ473□P-F			X5R	0.047 μ	±10, ±20	7.5	150	0.3±0.03	R		
JMK063 BJ683□P-F			X5R	0.068 μ	±10, ±20	10	150	0.3±0.03	R		
JMK063 BJ104□P-F			X5R	0.1 μ	±10, ±20	10	150	0.3±0.03	R		
JMK063 BJ224□P-F			X5R	0.22 μ	±10, ±20	10	150	0.3±0.03	R		
JMK063 BJ334MP-F			X5R	0.33 μ	±20	10	150	0.3±0.03	R		
JMK063 BJ474□P-F			X5R	0.47 μ	±10, ±20	10	150	0.3±0.03	R		
JMK063ABJ105□P-F		X5R	1 μ	±10, ±20	10	150	0.3±0.05	R			
AMK063 BJ224□P-F		4	X5R	0.22 μ	±10, ±20	10	150	0.3±0.03	R		
AMK063 BJ334MP-F			X5R	0.33 μ	±20	10	150	0.3±0.03	R		
AMK063 BJ474□P-F			X5R	0.47 μ	±10, ±20	10	150	0.3±0.03	R		
AMK063ABJ105□P-F			X5R	1 μ	±10, ±20	10	150	0.3±0.05	R		

[Temperature Characteristic C6 : X6S] 0.3mm thickness (P)

Part number 1	Part number 2	Rated voltage [V]	Temperature characteristics		Capacitance [F]	Capacitance tolerance [%]	tan δ [%]	HTLT		Thickness ^{*3} [mm]	Soldering R:Reflow W:Wave
								Rated voltage x %			
TMK063 C6104□P-F		25		X6S	0.1 μ	±10, ±20	10	150	0.3±0.03	R	
EMK063AC6104□P-F		16		X6S	0.1 μ	±10, ±20	10	150	0.3±0.05	R	
LMK063 C6333□P-F		10		X6S	0.033 μ	±10, ±20	7.5	150	0.3±0.03	R	
LMK063 C6473□P-F				X6S	0.047 μ	±10, ±20	7.5	150	0.3±0.03	R	
LMK063 C6683□P-F				X6S	0.068 μ	±10, ±20	10	150	0.3±0.03	R	
LMK063 C6104□P-F				X6S	0.1 μ	±10, ±20	10	150	0.3±0.03	R	
LMK063 C6224□P-F				X6S	0.22 μ	±10, ±20	10	150	0.3±0.03	R	
LMK063BC6474□PLF				X6S	0.47 μ	±10, ±20	10	150	0.3±0.09	R	
JMK063 C6223□P-F				X6S	0.022 μ	±10, ±20	7.5	200	0.3±0.03	R	
JMK063 C6333□P-F			6.3		X6S	0.033 μ	±10, ±20	7.5	150	0.3±0.03	R
JMK063 C6473□P-F				X6S	0.047 μ	±10, ±20	7.5	150	0.3±0.03	R	
JMK063 C6683□P-F				X6S	0.068 μ	±10, ±20	10	150	0.3±0.03	R	
JMK063 C6104□P-F				X6S	0.1 μ	±10, ±20	10	150	0.3±0.03	R	
JMK063 C6224□P-F				X6S	0.22 μ	±10, ±20	10	150	0.3±0.03	R	
JMK063BC6474□P-F				X6S	0.47 μ	±10, ±20	10	150	0.3±0.09	R	
JMK063BC6105MP-F				X6S	1 μ	±20	10	150	0.3±0.09	R	
AMK063 C6474□P-F		4			X6S	0.47 μ	±10, ±20	10	150	0.3±0.03	R
AMK063AC6105□P-F				X6S	1 μ	±10, ±20	10	150	0.3±0.05	R	

[Temperature Characteristic B7 : X7R] 0.3mm thickness (P)

Part number 1	Part number 2	Rated voltage [V]	Temperature characteristics	Capacitance [F]	Capacitance tolerance [%]	tan δ [%]	HTLT	Thickness*3 [mm]	Soldering R:Reflow W:Wave	
							Rated voltage x %			
UMK063 B7101□P-F		50	X7R	100 p	±10, ±20	3.5	200	0.3±0.03	R	
UMK063 B7151□P-F			X7R	150 p	±10, ±20	3.5	200	0.3±0.03	R	
UMK063 B7221□P-F			X7R	220 p	±10, ±20	3.5	200	0.3±0.03	R	
UMK063 B7331□P-F			X7R	330 p	±10, ±20	3.5	200	0.3±0.03	R	
UMK063 B7471□P-F			X7R	470 p	±10, ±20	3.5	200	0.3±0.03	R	
UMK063 B7681□P-F			X7R	680 p	±10, ±20	3.5	200	0.3±0.03	R	
UMK063 B7102□P-F			X7R	1000 p	±10, ±20	3.5	200	0.3±0.03	R	
TMK063 B7152□P-F			25	X7R	1500 p	±10, ±20	5	200	0.3±0.03	R
TMK063 B7222□P-F		X7R		2200 p	±10, ±20	5	200	0.3±0.03	R	
TMK063 B7332□P-F		X7R		3300 p	±10, ±20	5	200	0.3±0.03	R	
TMK063 B7472□P-F		X7R		4700 p	±10, ±20	5	200	0.3±0.03	R	
TMK063 B7682□P-F		X7R		6800 p	±10, ±20	5	200	0.3±0.03	R	
TMK063 B7103□P-F		X7R		0.01 μ	±10, ±20	5	200	0.3±0.03	R	
EMK063 B7152□P-F		16		X7R	1500 p	±10, ±20	5	200	0.3±0.03	R
EMK063 B7222□P-F				X7R	2200 p	±10, ±20	5	200	0.3±0.03	R
EMK063 B7332□P-F			X7R	3300 p	±10, ±20	5	200	0.3±0.03	R	
EMK063 B7472□P-F			X7R	4700 p	±10, ±20	5	200	0.3±0.03	R	
EMK063 B7682□P-F			X7R	6800 p	±10, ±20	5	200	0.3±0.03	R	
EMK063 B7103□P-F			X7R	0.01 μ	±10, ±20	5	200	0.3±0.03	R	
EMK063 B7223□P-F			X7R	0.022 μ	±10, ±20	7.5	150	0.3±0.03	R	

105TYPE

[Temperature Characteristic BJ : B/X5R] 0.5mm thickness (V)

Part number 1	Part number 2	Rated voltage [V]	Temperature characteristics	Capacitance [F]	Capacitance tolerance [%]	tan δ [%]	HTLT	Thickness*3 [mm]	Soldering R:Reflow W:Wave	
							Rated voltage x %			
UMK105 BJ221□V-F		50	B X5R ⁺¹	220 p	±10, ±20	2.5	200	0.5±0.05	R	
UMK105 BJ331□V-F			B X5R ⁺¹	330 p	±10, ±20	2.5	200	0.5±0.05	R	
UMK105 BJ471□V-F			B X5R ⁺¹	470 p	±10, ±20	2.5	200	0.5±0.05	R	
UMK105 BJ681□V-F			B X5R ⁺¹	680 p	±10, ±20	2.5	200	0.5±0.05	R	
UMK105 BJ102□V-F			B X5R ⁺¹	1000 p	±10, ±20	2.5	200	0.5±0.05	R	
UMK105 BJ152□V-F			B X5R ⁺¹	1500 p	±10, ±20	2.5	200	0.5±0.05	R	
UMK105 BJ222□V-F			B X5R ⁺¹	2200 p	±10, ±20	2.5	200	0.5±0.05	R	
UMK105 BJ332□V-F			B X5R ⁺¹	3300 p	±10, ±20	2.5	200	0.5±0.05	R	
UMK105 BJ472□V-F			B X5R ⁺¹	4700 p	±10, ±20	2.5	200	0.5±0.05	R	
UMK105 BJ682□V-F			B X5R ⁺¹	6800 p	±10, ±20	2.5	150	0.5±0.05	R	
UMK105 BJ103□V-F			B X5R ⁺¹	0.01 μ	±10, ±20	3.5	200	0.5±0.05	R	
UMK105 BJ104□V-F			X5R	0.1 μ	±10, ±20	10	150	0.5±0.05	R	
UMK105 BJ224□V-F			X5R	0.22 μ	±10, ±20	10	150	0.5±0.05	R	
UMK105ABJ474□V-F			X5R	0.47 μ	±10, ±20	10	150	0.5±0.10	R	
UMK105CBJ105MV-F			X5R	1 μ	±20	10	150	0.5+0.20/-0	R	
GMK105 BJ104□V-F			35	B X5R	0.1 μ	±10, ±20	5	150	0.5±0.05	R
GMK105ABJ105□V-F				X5R	1 μ	±10, ±20	10	150	0.5±0.10	R
TMK105 BJ153□V-F				B X5R ⁺¹	0.015 μ	±10, ±20	3.5	200	0.5±0.05	R
TMK105 BJ223□V-F				B X5R ⁺¹	0.022 μ	±10, ±20	3.5	200	0.5±0.05	R
TMK105 BJ333□V-F				B X5R ⁺¹	0.033 μ	±10, ±20	3.5	150	0.5±0.05	R
TMK105 BJ473□V-F		B X5R ⁺¹		0.047 μ	±10, ±20	3.5	150	0.5±0.05	R	
TMK105 BJ104□V-F		B X5R		0.1 μ	±10, ±20	5	150	0.5±0.05	R	
TMK105 BJ224□V-F		X5R		0.22 μ	±10, ±20	10	200	0.5±0.05	R	
TMK105ABJ474□V-F		X5R	0.47 μ	±10, ±20	10	200	0.5±0.10	R		
TMK105 BJ105□V-F		X5R	1 μ	±10, ±20	10	150	0.5±0.05	R		
TMK105CBJ225□V-F		X5R	2.2 μ	±10, ±20	10	150	0.5+0.20/-0	R		
EMK105 BJ153□V-F		16	B X5R ⁺¹	0.015 μ	±10, ±20	3.5	200	0.5±0.05	R	
EMK105 BJ223□V-F			B X5R ⁺¹	0.022 μ	±10, ±20	3.5	200	0.5±0.05	R	
EMK105 BJ333□V-F			B X5R ⁺¹	0.033 μ	±10, ±20	3.5	200	0.5±0.05	R	
EMK105 BJ473□V-F			B X5R ⁺¹	0.047 μ	±10, ±20	3.5	200	0.5±0.05	R	
EMK105 BJ683□V-F			B X5R	0.068 μ	±10, ±20	5	200	0.5±0.05	R	
EMK105 BJ104□V-F			B X5R ⁺¹	0.1 μ	±10, ±20	5	150	0.5±0.05	R	
EMK105 BJ224□V-F			B X5R	0.22 μ	±10, ±20	5	150	0.5±0.05	R	
EMK105ABJ474□V-F			X5R	0.47 μ	±10, ±20	10	200	0.5±0.10	R	
EMK105 BJ105□V-F			X5R	1 μ	±10, ±20	10	150	0.5±0.05	R	
EMK105ABJ225□V-F			X5R	2.2 μ	±10, ±20	10	150	0.5±0.10	R	
EMK105 BJ104□V-F			10	B X5R	0.1 μ	±10, ±20	5	200	0.5±0.05	R
LMK105 BJ224□V-F				B X5R	0.22 μ	±10, ±20	5	150	0.5±0.05	R
LMK105 BJ474□V-F		X5R		0.47 μ	±10, ±20	10	150	0.5±0.05	R	
LMK105 BJ105□V-F		X5R		1 μ	±10, ±20	10	150	0.5±0.05	R	
LMK105 BJ225□V-F		X5R		2.2 μ	±10, ±20	10	150	0.5±0.05	R	
LMK105BBJ475MVL-F		X5R		4.7 μ	±20	10	150	0.5+0.15/-0.05	R	
JMK105 BJ224□V-F		B X5R		0.22 μ	±10, ±20	5	150	0.5±0.05	R	
JMK105 BJ474□V-F		X5R		0.47 μ	±10, ±20	10	150	0.5±0.05	R	
JMK105 BJ105□V-F		6.3	X5R	1 μ	±10, ±20	10	150	0.5±0.05	R	
JMK105 BJ225□V-F			X5R	2.2 μ	±10, ±20	10	150	0.5±0.05	R	
JMK105BBJ475MV-F	JMK105 BJ475MV-FD		X5R	4.7 μ	±20	10	150	0.5+0.15/-0.05	R	
JMK105CBJ106MV-F			X5R	10 μ	±20	10	150	0.5+0.20/-0	R	
AMK105ABJ475MV-F	AMK105 BJ475MV-F	4	X5R	4.7 μ	±20	10	150	0.5±0.10	R	
AMK105CBJ106MV-F			X5R	10 μ	±20	10	150	0.5+0.20/-0	R	

▶ This catalog contains the typical specification only due to the limitation of space. When you consider the purchase of our products, please check our product specification sheets. For details of each product (characteristics graph, reliability information, precautions for use, and so on), see our website (<http://www.ty-top.com/>).

【Temperature Characteristic BJ : B/X5R】 0.3mm thickness(P)

Part number 1	Part number 2	Rated voltage [V]	Temperature characteristics	Capacitance [F]	Capacitance tolerance [%]	tan δ [%]	HTLT		Soldering R:Reflow W:Wave
							Rated voltage x %	Thickness ^{*3} [mm]	
UMK105 BJ104□P-F		50	X5R	0.1 μ	±10, ±20	10	150	0.3±0.03	R
TMK105 BJ103□P-F		25	B X5R	0.01 μ	±10, ±20	5	150	0.3±0.03	R
TMK105 BJ104□P-F			X5R	0.1 μ	±10, ±20	10	150	0.3±0.03	R
TMK105 BJ224□P-F			X5R	0.22 μ	±10, ±20	10	150	0.3±0.03	R
TMK105 BJ474□P-F			X5R	0.47 μ	±10, ±20	10	150	0.3±0.03	R
EMK105 BJ474□P-F			X5R	0.47 μ	±10, ±20	10	150	0.3±0.03	R
LMK105 BJ105□PLF		10	X5R	1 μ	±10, ±20	10	150	0.3±0.03	R
JMK105 BJ105□P-F		6.3	X5R	1 μ	±10, ±20	10	150	0.3±0.03	R
AMK105 BJ225MP-F		4	X5R	2.2 μ	±20	10	150	0.3±0.03	R

【Temperature Characteristic BJ : X5R】 0.2mm thickness(C)

Part number 1	Part number 2	Rated voltage [V]	Temperature characteristics	Capacitance [F]	Capacitance tolerance [%]	tan δ [%]	HTLT		Soldering R:Reflow W:Wave
							Rated voltage x %	Thickness ^{*3} [mm]	
LMK105 BJ104□C-F		10	X5R	0.1 μ	±10, ±20	10	150	0.2±0.02	R
JMK105 BJ224□C-F		6.3	X5R	0.22 μ	±10, ±20	10	150	0.2±0.02	R
JMK105 BJ474□C-F			X5R	0.47 μ	±10, ±20	10	150	0.2±0.02	R
JMK105 BJ105MC-F			X5R	1 μ	±20	10	150	0.2±0.02	R

【Temperature Characteristic BJ : X5R】 0.18mm thickness(E)

Part number 1	Part number 2	Rated voltage [V]	Temperature characteristics	Capacitance [F]	Capacitance tolerance [%]	tan δ [%]	HTLT		Soldering R:Reflow W:Wave
							Rated voltage x %	Thickness ^{*3} [mm]	
LMK105 BJ104□E-R		10	X5R	0.1 μ	±10, ±20	10	150	0.18±0.02	R
JMK105 BJ224□E-R		6.3	X5R	0.22 μ	±10, ±20	10	150	0.18±0.02	R
JMK105 BJ474□E-R			X5R	0.47 μ	±10, ±20	10	150	0.18±0.02	R
AMK105 BJ105ME-R			X5R	1 μ	±20	10	150	0.18±0.02	R

【Temperature Characteristic BJ : X5R】 0.13mm thickness(H)

Part number 1	Part number 2	Rated voltage [V]	Temperature characteristics	Capacitance [F]	Capacitance tolerance [%]	tan δ [%]	HTLT		Soldering R:Reflow W:Wave
							Rated voltage x %	Thickness ^{*3} [mm]	
LMK105 BJ104MH-R		10	X5R	0.1 μ	±20	10	150	0.13±0.02	R
JMK105 BJ224MH-R		6.3	X5R	0.22 μ	±20	10	150	0.13±0.02	R
AMK105 BJ474MH-R		4	X5R	0.47 μ	±20	10	150	0.13±0.02	R

【Temperature Characteristic C6 : X6S】 0.5mm thickness(V)

Part number 1	Part number 2	Rated voltage [V]	Temperature characteristics	Capacitance [F]	Capacitance tolerance [%]	tan δ [%]	HTLT		Soldering R:Reflow W:Wave
							Rated voltage x %	Thickness ^{*3} [mm]	
GMK105CC6105MV-F		35	X6S	1 μ	±20	10	150	0.5+0.20/-0	R
TMK105AC6105□V-F		25	X6S	1 μ	±10, ±20	10	150	0.5±0.10	R
EMK105 C6105□V-F			X6S	1 μ	±10, ±20	10	150	0.5±0.05	R
EMK105CC6225MV-F		16	X6S	2.2 μ	±20	10	150	0.5+0.20/-0	R
LMK105 C6105□V-F			X6S	1 μ	±10, ±20	10	200	0.5±0.05	R
LMK105AC6225MV-F		10	X6S	2.2 μ	±20	10	150	0.5±0.10	R
JMK105 C6105□V-F			X6S	1 μ	±10, ±20	10	150	0.5±0.05	R
JMK105 C6225MV-F			X6S	2.2 μ	±20	10	150	0.5±0.05	R
JMK105BC6475MV-F		6.3	X6S	4.7 μ	±20	10	150	0.5+0.15/-0.05	R
AMK105BC6475MV-F			X6S	4.7 μ	±20	10	200	0.5+0.15/-0.05	R

▶ This catalog contains the typical specification only due to the limitation of space. When you consider the purchase of our products, please check our product specification sheets. For details of each product (characteristics graph, reliability information, precautions for use, and so on), see our website (<http://www.ty-top.com/>).

【Temperature Characteristic B7 : X7R】 0.5mm thickness (V)

Part number 1	Part number 2	Rated voltage [V]	Temperature characteristics	Capacitance [F]	Capacitance tolerance [%]	tan δ [%]	HTLT		Thickness*3 [mm]	Soldering R/Reflow W/Wave
							Rated voltage x %			
UMK105 B7221□V-F		50	X7R	220 p	±10, ±20	2.5	200	0.5±0.05	R	
UMK105 B7331□V-F			X7R	330 p	±10, ±20	2.5	200	0.5±0.05	R	
UMK105 B7471□V-F			X7R	470 p	±10, ±20	2.5	200	0.5±0.05	R	
UMK105 B7681□V-F			X7R	680 p	±10, ±20	2.5	200	0.5±0.05	R	
UMK105 B7102□V-F			X7R	1000 p	±10, ±20	2.5	200	0.5±0.05	R	
UMK105 B7152□V-F			X7R	1500 p	±10, ±20	2.5	200	0.5±0.05	R	
UMK105 B7222□V-F			X7R	2200 p	±10, ±20	2.5	200	0.5±0.05	R	
UMK105 B7332□V-F			X7R	3300 p	±10, ±20	2.5	200	0.5±0.05	R	
UMK105 B7472□V-F			X7R	4700 p	±10, ±20	2.5	150	0.5±0.05	R	
UMK105 B7682□V-F			X7R	6800 p	±10, ±20	2.5	150	0.5±0.05	R	
UMK105 B7103□V-F			X7R	0.01 μ	±10, ±20	3.5	150	0.5±0.05	R	
UMK105 B7223□V-FR			X7R	0.022 μ	±10, ±20	10	200	0.5±0.05	R	
UMK105 B7473□V-FR			X7R	0.047 μ	±10, ±20	10	200	0.5±0.05	R	
UMK105 B7104□V-FR			X7R	0.1 μ	±10, ±20	10	150	0.5±0.05	R	
TMK105 B7152□V-F			25	X7R	1500 p	±10, ±20	2.5	200	0.5±0.05	R
TMK105 B7222□V-F				X7R	2200 p	±10, ±20	2.5	200	0.5±0.05	R
TMK105 B7332□V-F				X7R	3300 p	±10, ±20	2.5	200	0.5±0.05	R
TMK105 B7472□V-F				X7R	4700 p	±10, ±20	2.5	200	0.5±0.05	R
TMK105 B7682□V-F				X7R	6800 p	±10, ±20	2.5	200	0.5±0.05	R
TMK105 B7103□V-F				X7R	0.01 μ	±10, ±20	3.5	200	0.5±0.05	R
TMK105 B7223□V-F		X7R		0.022 μ	±10, ±20	3.5	150	0.5±0.05	R	
TMK105 B7473□V-F		X7R		0.047 μ	±10, ±20	3.5	150	0.5±0.05	R	
TMK105 B7104□V-FR		X7R		0.1 μ	±10, ±20	10	200	0.5±0.05	R	
TMK105 B7224□V-FR		X7R		0.22 μ	±10, ±20	10	150	0.5±0.05	R	
EMK105 B7223□V-F		16		X7R	0.022 μ	±10, ±20	3.5	200	0.5±0.05	R
EMK105 B7473□V-F				X7R	0.047 μ	±10, ±20	3.5	200	0.5±0.05	R
EMK105 B7104□V-F			X7R	0.1 μ	±10, ±20	5	150	0.5±0.05	R	
EMK105 B7224□V-FR			X7R	0.22 μ	±10, ±20	10	150	0.5±0.05	R	
LMK105 B7223□V-F			X7R	0.022 μ	±10, ±20	3.5	200	0.5±0.05	R	
LMK105 B7473□V-F			X7R	0.047 μ	±10, ±20	3.5	200	0.5±0.05	R	
LMK105 B7104□V-F		10	X7R	0.1 μ	±10, ±20	5	150	0.5±0.05	R	
LMK105 B7224□V-FR			X7R	0.22 μ	±10, ±20	10	150	0.5±0.05	R	
LMK105 B7474□V-F			X7R	0.47 μ	±10, ±20	10	150	0.5±0.05	R	
JMK105 B7224□V-F			6.3	X7R	0.22 μ	±10, ±20	5	150	0.5±0.05	R
JMK105 B7474□V-F		X7R		0.47 μ	±10, ±20	10	150	0.5±0.05	R	

● 107TYPE

【Temperature Characteristic BJ : B/X5R】 0.8mm thickness (A)

Part number 1	Part number 2	Rated voltage [V]	Temperature characteristics	Capacitance [F]	Capacitance tolerance [%]	tan δ [%]	HTLT		Thickness*3 [mm]	Soldering R/Reflow W/Wave
							Rated voltage x %			
UMK107ABJ474□A-T	UMK107 BJ474□A-TD	50	X5R	0.47 μ	±10, ±20	10	150	0.8±0.15/-0.05	R	
UMK107 BJ105□A-T			X5R	1 μ	±10, ±20	10	150	0.8±0.10	R	
UMK107BBJ225□A-T			X5R	2.2 μ	±10, ±20	10	150	0.8±0.20/-0	R	
GMK107 BJ105□A-T			35	B X5R	1 μ	±10, ±20	5	150	0.8±0.10	R
TMK107 BJ224□A-T				B X5R	0.22 μ	±10, ±20	3.5	200	0.8±0.10	R/W
TMK107 BJ474□A-T			25	B X5R	0.47 μ	±10, ±20	3.5	150	0.8±0.10	R
TMK107 BJ105□A-T				B X5R	1 μ	±10, ±20	5	150	0.8±0.10	R
TMK107ABJ225□A-T	TMK107 BJ225□A-TD			X5R	2.2 μ	±10, ±20	10	150	0.8±0.15/-0.05	R
TMK107BBJ475□A-T			16	X5R	4.7 μ	±10, ±20	10	150	0.8±0.20/-0	R
TMK107BBJ106MA-T				X5R	10 μ	±20	10	150	0.8±0.20/-0	R
EMK107 BJ224□A-T				B X5R ⁺	0.22 μ	±10, ±20	3.5	200	0.8±0.10	R/W
EMK107 BJ474□A-T				B X5R ⁺	0.47 μ	±10, ±20	3.5	200	0.8±0.10	R
EMK107 BJ105□A-T		B X5R ⁺		1 μ	±10, ±20	5	150	0.8±0.10	R	
EMK107 BJ225□A-T		B X5R		2.2 μ	±10, ±20	10	150	0.8±0.10	R	
EMK107ABJ475□A-T	EMK107 BJ475□A-TD	X5R		4.7 μ	±10, ±20	10	150	0.8±0.15/-0.05	R	
EMK107BBJ106MA-T		X5R		10 μ	±20	10	150	0.8±0.20/-0	R	
LMK107 BJ224□A-T		10		B X5R ⁺	0.22 μ	±10, ±20	3.5	200	0.8±0.10	R/W
LMK107 BJ474□A-T				B X5R ⁺	0.47 μ	±10, ±20	3.5	200	0.8±0.10	R
LMK107 BJ105□A-T				B X5R ⁺	1 μ	±10, ±20	5	200	0.8±0.10	R
LMK107 BJ225□A-T				B X5R	2.2 μ	±10, ±20	10	150	0.8±0.10	R
LMK107 BJ475□A-T			X5R	4.7 μ	±10, ±20	10	150	0.8±0.10	R	
LMK107BBJ106□ALTD	LMK107 BJ106□ALTD		X5R	10 μ	±10, ±20	10	150	0.8±0.20/-0	R	
LMK107BBJ226MA-T		6.3	X5R	22 μ	±20	10	150	0.8±0.20/-0	R	
JMK107 BJ225□A-T			B X5R	2.2 μ	±10, ±20	10	150	0.8±0.10	R	
JMK107 BJ475□A-T			X5R	4.7 μ	±10, ±20	10	150	0.8±0.10	R	
JMK107ABJ106□A-T	JMK107 BJ106□A-T		X5R	10 μ	±10, ±20	10	150	0.8±0.15/-0.05	R	
JMK107BBJ226MA-T			X5R	22 μ	±20	10	150	0.8±0.20/-0	R	
AMK107 BJ106MA-T			4	X5R	10 μ	±20	10	150	0.8±0.10	R
AMK107BBJ226MA-T	AMK107 BJ226MA-T	X5R		22 μ	±20	10	150	0.8±0.20/-0	R	

【Temperature Characteristic BJ : B/X5R】 0.45mm thickness (K)

Part number 1	Part number 2	Rated voltage [V]	Temperature characteristics	Capacitance [F]	Capacitance tolerance [%]	tan δ [%]	HTLT		Thickness*3 [mm]	Soldering R/Reflow W/Wave
							Rated voltage x %			
TMK107 BJ105□K-T		25	X5R	1 μ	±10, ±20	10	150	0.45±0.05	R	
EMK107 BJ105□K-T		16	X5R	1 μ	±10, ±20	10	150	0.45±0.05	R	
EMK107BBJ225□K-T			X5R	2.2 μ	±10, ±20	10	150	0.45±0.05	R	
LMK107 BJ105□K-T		10	B X5R	1 μ	±10, ±20	10	150	0.45±0.05	R	
LMK107 BJ225□K-T			X5R	2.2 μ	±10, ±20	10	150	0.45±0.05	R	
LMK107BBJ475MKLT	LMK107 BJ475MKLTD		X5R	4.7 μ	±20	10	150	0.45±0.05	R	
JMK107 BJ105□K-T		6.3	B X5R	1 μ	±10, ±20	10	150	0.45±0.05	R	
JMK107 BJ225□K-T			X5R	2.2 μ	±10, ±20	10	150	0.45±0.05	R	
JMK107 BJ475MK-T			X5R	4.7 μ	±20	10	150	0.45±0.05	R	
JMK107BBJ106MK-TT			X5R	10 μ	±20	10	150	0.45±0.05	R	
AMK107BBJ106MK-T*2		4	X5R	10 μ	±20	10	150	0.45±0.05	R	

▶ This catalog contains the typical specification only due to the limitation of space. When you consider the purchase of our products, please check our product specification sheets. For details of each product (characteristics graph, reliability information, precautions for use, and so on), see our website (<http://www.ty-top.com/>).

(Temperature Characteristic C6 : X6S) 0.8mm thickness (A)

Part number 1	Part number 2	Rated voltage [V]	Temperature characteristics		Capacitance [F]	Capacitance tolerance [%]	tan δ [%]	HTLT	Thickness ^{*3} [mm]	Soldering R:Reflow W:Wave
								Rated voltage x %		
TMK107BC6225□A-T		25		X6S	2.2 μ	±10, ±20	10	150	0.8+0.20/-0	R
EMK107 C6105□A-T								150		
EMK107BC6225□A-T		16		X6S	2.2 μ	±10, ±20	10	150	0.8+0.20/-0	R
EMK107BC6475□A-T								150		
EMK107BC6106MA-T								150		
EMK107BC6106MA-T								150		
LMK107 C6105□A-T		10		X6S	1 μ	±10, ±20	5	150	0.8±0.10	R
LMK107AC6475□A-T								150		
LMK107BC6106MA-T		6.3		X6S	4.7 μ	±10, ±20	10	150	0.8+0.15/-0.05	R
JMK107 C6105□A-T								150		
JMK107 C6475□A-T								150		
JMK107BC6106MA-T								150		
JMK107BC6226MA-T		4		X6S	10 μ	±20	10	150	0.8+0.15/-0.05	R
AMK107AC6106MA-T								150		
AMK107BC6226MA-T				X6S	22 μ	±20	10	150	0.8+0.20/-0	R

(Temperature Characteristic B7 : X7R) 0.8mm thickness (A)

Part number 1	Part number 2	Rated voltage [V]	Temperature characteristics		Capacitance [F]	Capacitance tolerance [%]	tan δ [%]	HTLT	Thickness ^{*3} [mm]	Soldering R:Reflow W:Wave
								Rated voltage x %		
UMK107 B7224□A-TR		50		X7R	0.22 μ	±10, ±20	10	150	0.8±0.10	R
UMK107 B7474□A-TR								150		
UMK107AB7105□A-T								150		
TMK107 B7474□A-TR		25		X7R	0.47 μ	±10, ±20	10	150	0.8±0.10	R
TMK107 B7105□A-T								150		
EMK107 B7224□A-T		16		X7R	0.22 μ	±10, ±20	3.5	150	0.8±0.10	R/W
EMK107 B7474□A-T								150		
EMK107 B7105□A-T								150		
EMK107BB7225□A-T								150		
LMK107 B7224□A-T		10		X7R	0.22 μ	±10, ±20	3.5	200	0.8±0.10	R/W
LMK107 B7474□A-T								200		
LMK107 B7105□A-T								150		
LMK107 B7225□A-TR		6.3		X7R	2.2 μ	±10, ±20	10	150	0.8±0.10	R
JMK107 B7224□A-T								200		
JMK107 B7474□A-T								200		
JMK107 B7105□A-T								150		
JMK107 B7225□A-TR				X7R	2.2 μ	±10, ±20	10	200	0.8±0.10	R
JMK107BB7475□A-T								150		

● 212TYPE

(Temperature Characteristic BJ : B/X5R) 1.25mm thickness (G)

Part number 1	Part number 2	Rated voltage [V]	Temperature characteristics		Capacitance [F]	Capacitance tolerance [%]	tan δ [%]	HTLT	Thickness ^{*3} [mm]	Soldering R:Reflow W:Wave
								Rated voltage x %		
UMK212 BJ104□G-T		50		B	X5R ^{*1}	0.1 μ	±10, ±20	3.5	1.25±0.10	R/W
UMK212 BJ224□G-T								200		
UMK212 BJ474□G-T								150		
UMK212 BJ105□G-T								150		
UMK212ABJ225□G-T								150		
UMK212BBJ475□G-T								150		
GMK212BBJ106□G-T		35		X5R	10 μ	±10, ±20	10	150	1.25+0.20/-0	R
TMK212 BJ225□G-T								150		
TMK212ABJ475□G-T	TMK212 BJ475□G-T	25		X5R	4.7 μ	±10, ±20	10	150	1.25+0.15/-0.05	R
TMK212BBJ106MG-T								150		
TMK212BBJ226MG-TT		16		X5R	2.2 μ	±10, ±20	5	200	1.25±0.10	R
EMK212 BJ225□G-T								150		
EMK212ABJ475□G-T	EMK212 BJ475□G-T							150		
EMK212ABJ106□G-T	EMK212 BJ106□G-T							150		
EMK212BBJ226MG-T		10		X5R	22 μ	±20	10	150	1.25+0.20/-0	R
LMK212 BJ225□G-T								200		
LMK212ABJ475□G-T	LMK212 BJ475□G-T			B	X5R ^{*1}	4.7 μ	±10, ±20	5	1.25+0.15/-0.05	R
LMK212ABJ106□G-T	LMK212 BJ106□G-T							200		
LMK212BBJ226MG-T	LMK212 BJ226MG-T	6.3		X5R	10 μ	±10, ±20	10	200	1.25+0.15/-0.05	R
LMK212BBJ476MG-T								150		
JMK212ABJ475□G-T	JMK212 BJ475□G-T			B	X5R	4.7 μ	±10, ±20	5	1.25+0.15/-0.05	R
JMK212ABJ106□G-T	JMK212 BJ106□G-T							200		
JMK212ABJ226MG-T	JMK212 BJ226MG-T			X5R	22 μ	±20	10	150	1.25+0.15/-0.05	R
JMK212BBJ476MG-T	JMK212 BJ476MG-T							150		
PMK212BBJ107MG-T		2.5		X5R	100 μ	±20	10	150	1.25+0.20/-0	R

▶ This catalog contains the typical specification only due to the limitation of space. When you consider the purchase of our products, please check our product specification sheets. For details of each product (characteristics graph, reliability information, precautions for use, and so on), see our website (<http://www.ty-top.com/>).

316TYPE

[Temperature Characteristic BJ : B/X5R] 1.6mm thickness(L)

Table with 11 columns: Part number 1, Part number 2, Rated voltage [V], Temperature characteristics, Capacitance [F], Capacitance tolerance [%], tan δ [%], HTLT Rated voltage x %, Thickness*3 [mm], Soldering R:Reflow W:Wave. Includes parts like UMK316 BJ105□L-T, UMK316 BJ225□L-T, etc.

[Temperature Characteristic BJ : B/X5R] 0.85mm thickness(D)

Table with 11 columns: Part number 1, Part number 2, Rated voltage [V], Temperature characteristics, Capacitance [F], Capacitance tolerance [%], tan δ [%], HTLT Rated voltage x %, Thickness*3 [mm], Soldering R:Reflow W:Wave. Includes parts like UMK316 BJ105□D-T, UMK316 BJ225□D-T, etc.

[Temperature Characteristic C6 : X6S] 1.6mm thickness(L)

Table with 11 columns: Part number 1, Part number 2, Rated voltage [V], Temperature characteristics, Capacitance [F], Capacitance tolerance [%], tan δ [%], HTLT Rated voltage x %, Thickness*3 [mm], Soldering R:Reflow W:Wave. Includes parts like EMK316BC6226ML-T, JMK316AC6476ML-T, etc.

[Temperature Characteristic C7 : X7S] 1.6mm thickness(L)

Table with 11 columns: Part number 1, Part number 2, Rated voltage [V], Temperature characteristics, Capacitance [F], Capacitance tolerance [%], tan δ [%], HTLT Rated voltage x %, Thickness*3 [mm], Soldering R:Reflow W:Wave. Includes part AMK316AC7476ML-T.

[Temperature Characteristic B7 : X7R] 1.6mm thickness(L)

Table with 11 columns: Part number 1, Part number 2, Rated voltage [V], Temperature characteristics, Capacitance [F], Capacitance tolerance [%], tan δ [%], HTLT Rated voltage x %, Thickness*3 [mm], Soldering R:Reflow W:Wave. Includes parts like UMK316 B7224□L-T, UMK316 B7474□L-T, etc.

► This catalog contains the typical specification only due to the limitation of space. When you consider the purchase of our products, please check our product specification sheets. For details of each product (characteristics graph, reliability information, precautions for use, and so on), see our website (<http://www.ty-top.com/>) .

CERAMIC CAPACITORS

■ PARTS NUMBER

[Temperature Characteristic B7 : X7R] 0.85mm thickness (D)

Part number 1	Part number 2	Rated voltage [V]	Temperature characteristics		Capacitance [F]	Capacitance tolerance [%]	tan δ [%]	HTLT	Thickness*3 [mm]	Soldering R:Reflow W:Wave
								Rated voltage x %		
UMK316 B7225[D-T]		50		X7R	2.2 μ	±10, ±20	10	150	0.85±0.10	R
TMK316AB7475[D-T]		25		X7R	4.7 μ	±10, ±20	10	150	0.85±0.10	R
LMK316AB7106MD-T		10		X7R	10 μ	±20	10	150	0.85±0.10	R

● 325TYPE

[Temperature Characteristic BJ : B/X5R] 2.5mm thickness (M)

Part number 1	Part number 2	Rated voltage [V]	Temperature characteristics		Capacitance [F]	Capacitance tolerance [%]	tan δ [%]	HTLT	Thickness*3 [mm]	Soldering R:Reflow W:Wave
								Rated voltage x %		
UMK325 BJ475[M-P]		50		X5R	4.7 μ	±10, ±20	5	150	2.5±0.20	R
UMK325 BJ106[M-P]				X5R	10 μ	±10, ±20	5	150	2.5±0.20	R
GMK325 BJ226MM-P		35		X5R	22 μ	±20	5	150	2.5±0.20	R
TMK325 BJ106[M-P]			B	X5R*1	10 μ	±10, ±20	3.5	150	2.5±0.20	R
TMK325 BJ226[M-P]		25		X5R	22 μ	±10, ±20	5	150	2.5±0.20	R
TMK325ABJ476MM-P				X5R	47 μ	±20	10	150	2.5±0.30	R
EMK325 BJ226[M-P]		16	B	X5R	22 μ	±10, ±20	5	150	2.5±0.20	R
EMK325 BJ476MM-P				X5R	47 μ	±20	10	150	2.5±0.20	R
EMK325ABJ107MM-P		10		X5R	100 μ	±20	10	150	2.5±0.30	R
LMK325 BJ226[M-P]			B	X5R	22 μ	±10, ±20	5	200	2.5±0.20	R
LMK325 BJ476MM-P		10		X5R	47 μ	±20	10	150	2.5±0.20	R
LMK325ABJ107MM-P	LMK325 BJ107MM-P			X5R	100 μ	±20	10	150	2.5±0.30	R
LMK325ABJ227MM-PE		6.3		X5R	220 μ	±20	10	150	2.5±0.30	R
JMK325 BJ476MM-P				X5R	47 μ	±20	10	150	2.5±0.20	R
JMK325ABJ107MM-P		6.3		X5R	100 μ	±20	10	150	2.5±0.30	R
JMK325ABJ157MM-P				X5R	150 μ	±20	10	150	2.5±0.30	R
JMK325ABJ227MM-P		4		X5R	220 μ	±20	10	150	2.5±0.30	R
JMK325ABJ337MM-P				X5R	330 μ	±20	10	150	2.5±0.30	R
AMK325ABJ157MM-P		4		X5R	150 μ	±20	10	150	2.5±0.30	R
AMK325ABJ227MM-P				X5R	220 μ	±20	10	150	2.5±0.30	R
AMK325ABJ337MM-P			X5R	330 μ	±20	10	150	2.5±0.30	R	

[Temperature Characteristic BJ : B/X5R] 1.9mm thickness (Y,N)

Part number 1	Part number 2	Rated voltage [V]	Temperature characteristics		Capacitance [F]	Capacitance tolerance [%]	tan δ [%]	HTLT	Thickness*3 [mm]	Soldering R:Reflow W:Wave
								Rated voltage x %		
UMK325 BJ475[N-T]		50		X5R	4.7 μ	±10, ±20	10	150	1.9±0.20	R
GMK325 BJ225[N-T]			B	X5R	2.2 μ	±10, ±20	3.5	200	1.9±0.20	R
GMK325 BJ475[N-T]		35		X5R	4.7 μ	±10, ±20	10	150	1.9±0.20	R
GMK325 BJ106[N-T]			B	X5R	10 μ	±10, ±20	5	150	1.9±0.20	R
TMK325 BJ335MN-T		25	B	X5R*1	3.3 μ	±20	3.5	200	1.9±0.20	R
TMK325 BJ475[N-T]			B	X5R*1	4.7 μ	±10, ±20	3.5	200	1.9±0.20	R
TMK325 BJ106[N-T]		16	B	X5R	10 μ	±10, ±20	5	200	1.9±0.20	R
EMK325 BJ475[N-T]			B	X5R*1	4.7 μ	±10, ±20	3.5	200	1.9±0.20	R
EMK325 BJ106[N-T]		10		X5R	10 μ	±10, ±20	3.5	200	1.9±0.20	R
EMK325 BJ476MY-T				X5R	47 μ	±20	10	150	1.9+0.1/-0.2	R
LMK325 BJ226MY-T		10	B	X5R	22 μ	±20	5	150	1.9+0.1/-0.2	R
LMK325 BJ106[N-T]			B	X5R	10 μ	±10, ±20	3.5	200	1.9±0.20	R
JMK325 BJ226MY-T		6.3	B	X5R	22 μ	±20	5	200	1.9+0.1/-0.2	R
JMK325 BJ107MY-T				X5R	100 μ	±20	10	150	1.9+0.1/-0.2	R
JMK325 BJ476MN-T			X5R	47 μ	±20	10	150	1.9±0.20	R	

[Temperature Characteristic BJ : B/X5R] 0.85mm thickness (D)

Part number 1	Part number 2	Rated voltage [V]	Temperature characteristics		Capacitance [F]	Capacitance tolerance [%]	tan δ [%]	HTLT	Thickness*3 [mm]	Soldering R:Reflow W:Wave
								Rated voltage x %		
TMK325 BJ106[D-T]		25	B	X5R	10 μ	±10, ±20	5	150	0.85±0.10	R
EMK325 BJ106[D-T]			B	X5R	10 μ	±10, ±20	5	150	0.85±0.10	R
EMK325 BJ226MD-T		16	B	X5R	22 μ	±20	10	150	0.85±0.10	R
LMK325 BJ335[D-T]			B	X5R	3.3 μ	±10, ±20	3.5	200	0.85±0.10	R
LMK325 BJ475[D-T]		10	B	X5R	4.7 μ	±10, ±20	5	200	0.85±0.10	R
LMK325 BJ106[D-T]			B	X5R	10 μ	±10, ±20	5	150	0.85±0.10	R

[Temperature Characteristic C6 : X6S] 2.5mm thickness (M)

Part number 1	Part number 2	Rated voltage [V]	Temperature characteristics		Capacitance [F]	Capacitance tolerance [%]	tan δ [%]	HTLT	Thickness*3 [mm]	Soldering R:Reflow W:Wave
								Rated voltage x %		
EMK325AC6476MM-P		16		X6S	47 μ	±20	10	150	2.5±0.30	R
LMK325AC6107MM-P		10		X6S	100 μ	±20	10	150	2.5±0.30	R
JMK325AC6227MM-PE		6.3		X6S	220 μ	±20	10	150	2.5±0.30	R
JMK325AC6107MM-P				X6S	100 μ	±20	10	150	2.5±0.30	R
AMK325AC6157MM-P		4		X6S	150 μ	±20	10	150	2.5±0.30	R
AMK325AC6227MM-P				X6S	220 μ	±20	10	150	2.5±0.30	R
AMK325AC6337MM-P		2.5		X6S	330 μ	±20	10	150	2.5±0.30	R
PMK325AC6337MM-P				X6S	330 μ	±20	10	150	2.5±0.30	R

[Temperature Characteristic C7 : X7S] 2.5mm thickness (M)

Part number 1	Part number 2	Rated voltage [V]	Temperature characteristics		Capacitance [F]	Capacitance tolerance [%]	tan δ [%]	HTLT	Thickness*3 [mm]	Soldering R:Reflow W:Wave
								Rated voltage x %		
JMK325AC7107MM-P		6.3		X7S	100 μ	±20	10	150	2.5±0.30	R

▶ This catalog contains the typical specification only due to the limitation of space. When you consider the purchase of our products, please check our product specification sheets. For details of each product (characteristics graph, reliability information, precautions for use, and so on), see our website (<http://www.ty-top.com/>).

【Temperature Characteristic B7 : X7R】 2.5mm thickness (M)

Part number 1	Part number 2	Rated voltage [V]	Temperature characteristics	Capacitance [F]	Capacitance tolerance [%]	tan δ [%]	HTLT		Soldering R:Reflow W:Wave
							Rated voltage x %	Thickness ^{*3} [mm]	
UMK325 B7335□M-P		50	X7R	3.3 μ	±10, ±20	3.5	200	2.5±0.20	R
UMK325 B7475□M-P			X7R	4.7 μ	±10, ±20	5	150	2.5±0.20	R
UMK325AB7106□M-P			X7R	10 μ	±10, ±20	10	150	2.5±0.30	R
TMK325AB7106□M-P		25	X7R	10 μ	±10, ±20	10	200	2.5±0.30	R
TMK325 B7226□M-PR			X7R	22 μ	±10, ±20	10	150	2.5±0.20	R
EMK325 B7226□M-PR		16	X7R	22 μ	±10, ±20	10	150	2.5±0.20	R
LMK325 B7476□M-PR		10	X7R	47 μ	±10, ±20	10	150	2.5±0.20	R
JMK325 B7476□M-PR		6.3	X7R	47 μ	±10, ±20	10	200	2.5±0.20	R

【Temperature Characteristic B7 : X7R】 1.9mm thickness (N)

Part number 1	Part number 2	Rated voltage [V]	Temperature characteristics	Capacitance [F]	Capacitance tolerance [%]	tan δ [%]	HTLT		Soldering R:Reflow W:Wave
							Rated voltage x %	Thickness ^{*3} [mm]	
UMK325 B7475□N-TR		50	X7R	4.7 μ	±10, ±20	10	150	1.9±0.20	R
TMK325 B7335□N-T			X7R	3.3 μ	±10, ±20	3.5	200	1.9±0.20	R
TMK325 B7475□N-T		25	X7R	4.7 μ	±10, ±20	3.5	150	1.9±0.20	R
TMK325 B7106□N-TR			X7R	10 μ	±10, ±20	10	150	1.9±0.20	R
EMK325 B7475□N-T		16	X7R	4.7 μ	±10, ±20	3.5	200	1.9±0.20	R
EMK325 B7106□N-T			X7R	10 μ	±10, ±20	3.5	150	1.9±0.20	R
LMK325 B7106□N-T		10	X7R	10 μ	±10, ±20	3.5	200	1.9±0.20	R

● 432TYPE

【Temperature Characteristic BJ : X5R】 2.5mm thickness (M)

Part number 1	Part number 2	Rated voltage [V]	Temperature characteristics	Capacitance [F]	Capacitance tolerance [%]	tan δ [%]	HTLT		Soldering R:Reflow W:Wave
							Rated voltage x %	Thickness ^{*3} [mm]	
AMK432 BJ477MM-T		4	X5R	470 μ	±20	10	150	2.5±0.20	R

【Temperature Characteristic C6 : X6S】 2.5mm thickness (M)

Part number 1	Part number 2	Rated voltage [V]	Temperature characteristics	Capacitance [F]	Capacitance tolerance [%]	tan δ [%]	HTLT		Soldering R:Reflow W:Wave
							Rated voltage x %	Thickness ^{*3} [mm]	
PMK432 C6477MM-T		2.5	X6S	470 μ	±20	10	150	2.5±0.20	R

▶ This catalog contains the typical specification only due to the limitation of space. When you consider the purchase of our products, please check our product specification sheets. For details of each product (characteristics graph, reliability information, precautions for use, and so on), see our website (<http://www.ty-top.com/>).

Multilayer Ceramic Capacitors

PACKAGING

① Minimum Quantity

● Taped package

Type(EIA)	Thickness		Standard quantity [pcs]	
	mm	code	Paper tape	Embossed tape
<input type="checkbox"/> MK021(008004)	0.125	K	—	50000
<input type="checkbox"/> VS021(008004)				
<input type="checkbox"/> MK042(01005)	0.2	C, D	—	40000
<input type="checkbox"/> VS042(01005)	0.2	C		
<input type="checkbox"/> MK063(0201)	0.3	P, T	15000	—
<input type="checkbox"/> WK105(0204) ※	0.3	P	10000	—
<input type="checkbox"/> MK105(0402) <input type="checkbox"/> MF105(0402)	0.13	H	—	20000
	0.18	E	—	15000
	0.2	C	20000	—
	0.3	P	15000	—
	0.5	V	10000	—
<input type="checkbox"/> VK105(0402)	0.5	W	10000	—
<input type="checkbox"/> MK107(0603)	0.45	K	4000	—
<input type="checkbox"/> WK107(0306) ※	0.5	V	—	4000
<input type="checkbox"/> MF107(0603)	0.8	A	4000	—
<input type="checkbox"/> VS107(0603)	0.7	C	4000	—
<input type="checkbox"/> MJ107(0603)	0.8	A	3000	3000
<input type="checkbox"/> MK212(0805)	0.45	K	4000	—
<input type="checkbox"/> WK212(0508) ※	0.85	D		
<input type="checkbox"/> MF212(0805)	1.25	G	—	3000
<input type="checkbox"/> VS212(0805)	0.85	D	4000	—
<input type="checkbox"/> MJ212(0805)	0.85	D	4000	—
	1.25	G	—	2000
<input type="checkbox"/> MK316(1206) <input type="checkbox"/> MF316(1206)	0.85	D	4000	—
	1.15	F	—	3000
	1.6	L	—	2000
<input type="checkbox"/> MJ316(1206)	1.15	F	—	3000
	1.6	L	—	2000
<input type="checkbox"/> MK325(1210) <input type="checkbox"/> MF325(1210)	0.85	D	—	2000
	1.15	F		
	1.9	N		
	2.0max.	Y		
<input type="checkbox"/> MJ325(1210)	2.5	M	—	1000
	1.9	N	—	2000
<input type="checkbox"/> MK432(1812)	2.5	M	—	500(T), 1000(P)
	2.5	M	—	500

Note : ※ LW Reverse type.

② Taping material

※No bottom tape for pressed carrier tape

● Card board carrier tape

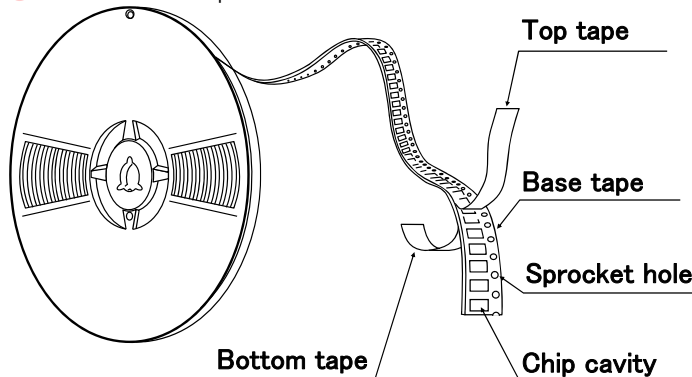

● Embossed tape

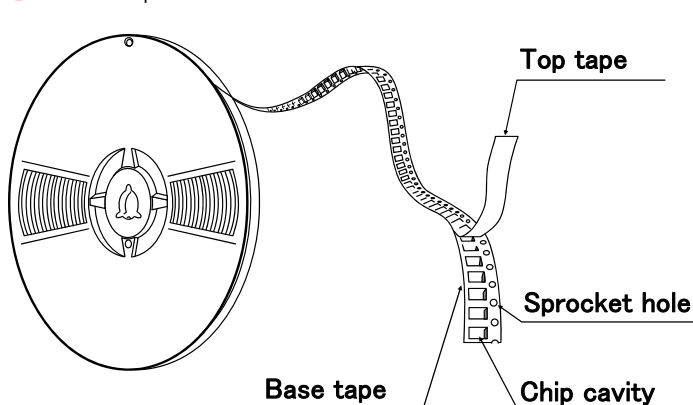

▶ This catalog contains the typical specification only due to the limitation of space. When you consider the purchase of our products, please check our specification. For details of each product (characteristics graph, reliability information, precautions for use, and so on), see our Web site (<http://www.ty-top.com/>).

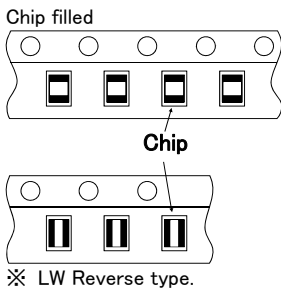

③ Representative taping dimensions

● Paper Tape (8mm wide)

● Pressed carrier tape (2mm pitch)

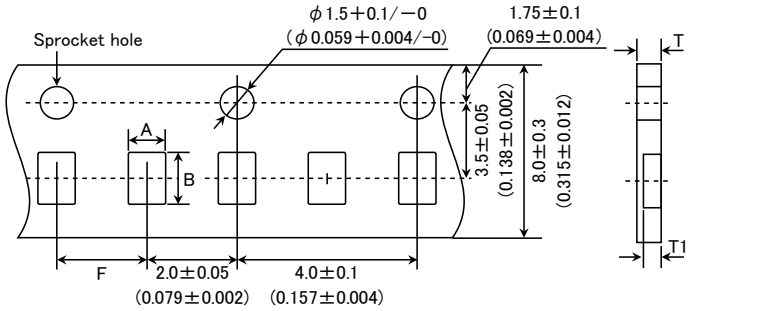

Type(EIA)	Chip Cavity		Insertion Pitch F	Tape Thickness	
	A	B		T	T1
□MK063(0201)	0.37	0.67	2.0±0.05	0.45max.	0.42max.
□WK105(0204) ※	0.65	1.15		0.4max.	0.3max.
□MK105(0402) (*1 C)				0.45max.	0.42max.
□MK105(0402) (*1 P)					

Note *1 Thickness, C:0.2mm ,P:0.3mm. ※ LW Reverse type.

Unit : mm

● Punched carrier tape (2mm pitch)

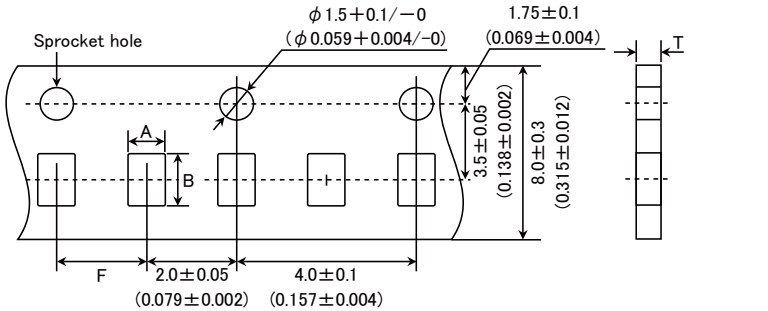

Type(EIA)	Chip Cavity		Insertion Pitch F	Tape Thickness
	A	B		T
□MK105 (0402)	0.65	1.15	2.0±0.05	0.8max.
□MF105 (0402)				
□VK105 (0402)				

Unit : mm

● Punched carrier tape (4mm pitch)

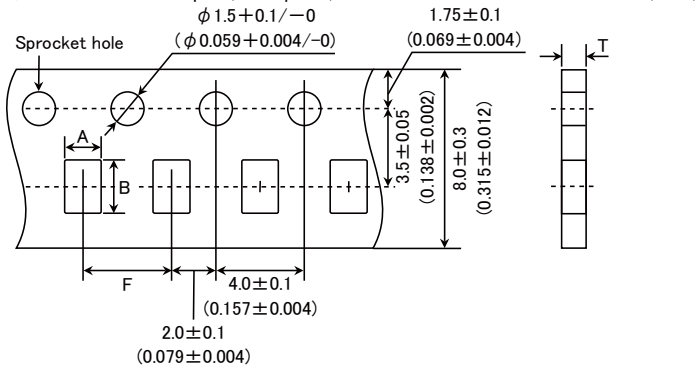

Type(EIA)	Chip Cavity		Insertion Pitch	Tape Thickness	
	A	B		F	T
□MK107(0603) □WK107(0306) ※ □MF107(0603)	1.0	1.8	4.0±0.1	1.1max.	
□MK212(0805) □WK212(0508) ※ □MK316(1206)				1.65	2.4
	2.0	3.6			

Note: Taping size might be different depending on the size of the product. ※ LW Reverse type.

Unit: mm

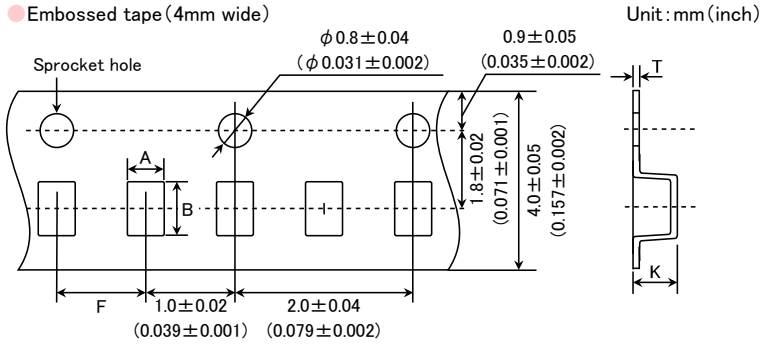

Type(EIA)	Chip Cavity		Insertion Pitch	Tape Thickness	
	A	B		F	K
□MK021(008004) □VS021(008004)	0.135	0.27	1.0±0.02	0.5max.	0.25max.
□MK042(01005) □VS042(01005)					

Unit: mm

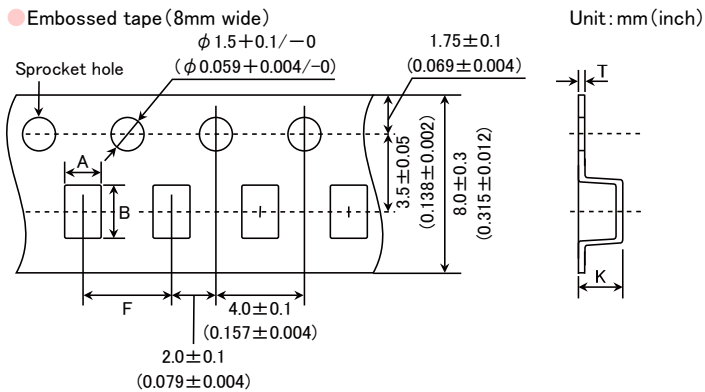

Type(EIA)	Chip Cavity		Insertion Pitch	Tape Thickness	
	A	B		F	K
□MK105(0402) □WK107(0306) ※ □MK212(0805) □MF212(0805)	0.6	1.1	2.0±0.1	0.6max.	0.2±0.1
□MK316(1206) □MF316(1206)	2.0	3.6	4.0±0.1	3.4max.	0.6max.
□MK325(1210) □MF325(1210)	2.8	3.6			

Note: ※ LW Reverse type.

Unit: mm

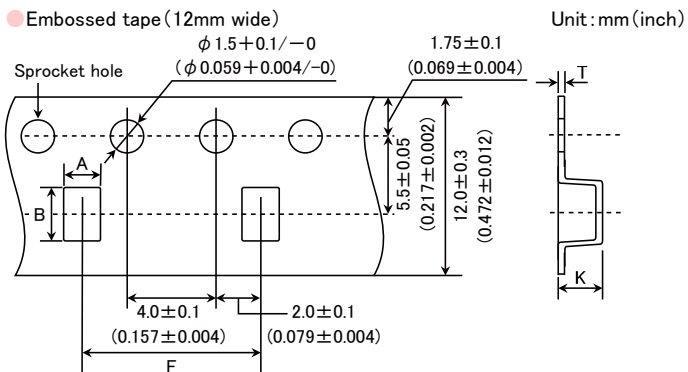

Type(EIA)	Chip Cavity		Insertion Pitch F	Tape Thickness	
	A	B		K	T
□MK325(1210)	3.1	4.0	8.0±0.1	4.0max.	0.6max.
□MK432(1812)	3.7	4.9	8.0±0.1	4.0max.	0.6max.

Unit: mm

④Trailer and Leader

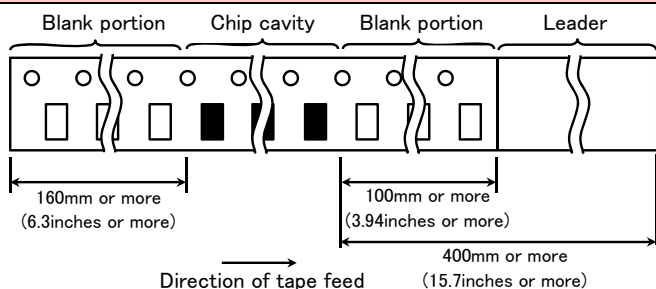

⑤Reel size

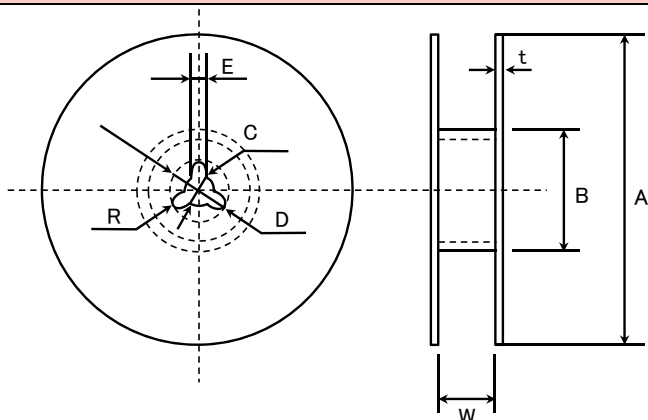

A	B	C	D	E	R
$\phi 178 \pm 2.0$	$\phi 50 \text{ min.}$	$\phi 13.0 \pm 0.2$	$\phi 21.0 \pm 0.8$	2.0 ± 0.5	1.0

	T	W
4mm wide tape	1.5max.	5 ± 1.0
8mm wide tape	2.5max.	10 ± 1.5
12mm wide tape	2.5max.	14 ± 1.5

Unit: mm

⑥Top Tape Strength

The top tape requires a peel-off force of 0.1 to 0.7N in the direction of the arrow as illustrated below.

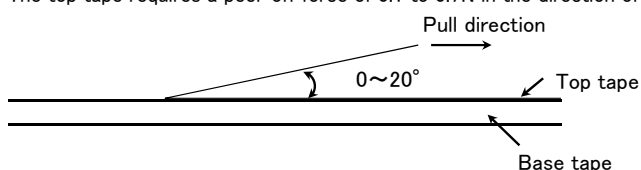

▶ This catalog contains the typical specification only due to the limitation of space. When you consider the purchase of our products, please check our specification. For details of each product (characteristics graph, reliability information, precautions for use, and so on), see our Web site (<http://www.ty-top.com/>).

Multilayer Ceramic Capacitors

RELIABILITY DATA

1. Operating Temperature Range

Specified Value	Temperature Compensating (Class1)	Standard	-55 to +125°C	
		High Frequency Type		
Specified Value	High Permittivity (Class2)		Specification	Temperature Range
		BJ	B	-25 to +85°C
			X5R	-55 to +85°C
		B7	X7R	-55 to +125°C
		C6	X6S	-55 to +105°C
		C7	X7S	-55 to +125°C
		LD(※)	X5R	-55 to +85°C
Note: ※LD Low distortion high value multilayer ceramic capacitor				

2. Storage Conditions

Specified Value	Temperature Compensating (Class1)	Standard	-55 to +125°C	
		High Frequency Type		
Specified Value	High Permittivity (Class2)		Specification	Temperature Range
		BJ	B	-25 to +85°C
			X5R	-55 to +85°C
		B7	X7R	-55 to +125°C
		C6	X6S	-55 to +105°C
		C7	X7S	-55 to +125°C
		LD(※)	X5R	-55 to +85°C
Note: ※LD Low distortion high value multilayer ceramic capacitor				

3. Rated Voltage

Specified Value	Temperature Compensating (Class1)	Standard	50VDC, 25VDC, 16VDC
		High Frequency Type	50VDC, 25VDC, 16VDC
	High Permittivity (Class2)		50VDC, 35VDC, 25VDC, 16VDC, 10VDC, 6.3VDC, 4VDC, 2.5VDC

4. Withstanding Voltage (Between terminals)

Specified Value	Temperature Compensating (Class1)	Standard	No breakdown or damage
		High Frequency Type	
Test Methods and Remarks	High Permittivity (Class2)		
		Class 1	Class 2
	Applied voltage	Rated voltage × 3	Rated voltage × 2.5
	Duration	1 to 5 sec.	
	Charge/discharge current	50mA max.	

5. Insulation Resistance

Specified Value	Temperature Compensating (Class1)	Standard	10000 MΩ min.
		High Frequency Type	
	High Permittivity (Class2) Note 1		C ≤ 0.047 μF : 10000 MΩ min. C > 0.047 μF : 500MΩ · μF
Test Methods and Remarks	Applied voltage	: Rated voltage	
	Duration	: 60 ± 5 sec.	
	Charge/discharge current	: 50mA max.	

▶ This catalog contains the typical specification only due to the limitation of space. When you consider the purchase of our products, please check our specification. For details of each product (characteristics graph, reliability information, precautions for use, and so on), see our Web site (<http://www.ty-top.com/>).

6. Capacitance (Tolerance)

Specified Value	Temperature Compensating(Class1)	Standard	C□	0.2pF ≤ C ≤ 5pF	: ±0.25pF
			U□	0.2pF ≤ C ≤ 10pF	: ±0.5pF
	SL	C > 10pF	: ±5% or ±10%		
		High Frequency Type	CG	0.2pF ≤ C ≤ 2pF	: ±0.1pF
				C > 2pF	: ±5%
	High Permittivity (Class2)		±10% or ±20%		

Test Methods and Remarks		Class 1		Class 2	
		Standard	High Frequency Type	C ≤ 10 μF	C > 10 μF
	Preconditioning	None		Thermal treatment (at 150°C for 1hr) Note 2	
	Measuring frequency	1MHz ± 10%		1kHz ± 10%	120 ± 10Hz
	Measuring voltage Nte	0.5 to 5Vrms		1 ± 0.2Vrms	0.5 ± 0.1Vrms
Bias application	None				

7. Q or Dissipation Factor

Specified Value	Temperature Compensating(Class1)	Standard	C < 30pF : Q ≥ 400 + 20C C ≥ 30pF : Q ≥ 1000 (C: Nominal capacitance)
		High Frequency Type	Refer to detailed specification
	High Permittivity (Class2) Note 1		BJ, B7, C6, C7: 2.5% max.

Test Methods and Remarks		Class 1		Class 2	
		Standard	High Frequency Type	C ≤ 10 μF	C > 10 μF
	Preconditioning	None		Thermal treatment (at 150°C for 1hr) Note 2	
	Measuring frequency	1MHz ± 10%	1GHz	1kHz ± 10%	120 ± 10Hz
	Measuring voltage Note 1	0.5 to 5Vrms		1 ± 0.2Vrms	0.5 ± 0.1Vrms
Bias application	None				
	High Frequency Type Measuring equipment : HP4291A Measuring jig : HP16192A				

8. Temperature Characteristic (Without voltage application)

Specified Value	Temperature Compensating(Class1)	Standard	Temperature Characteristic [ppm/°C]		Tolerance [ppm/°C]			
			C□ : 0	CG	G : ±30			
			U□ : -750	UJ, UK	J : ±120 K : ±250			
			SL : +350 to -1000					
		High Frequency Type	Temperature Characteristic [ppm/°C]		Tolerance [ppm/°C]			
			C□ : 0	CG	G : ±30			
Test Methods and Remarks	High Permittivity (Class2)		Specification	Capacitance change	Reference temperature	Temperature Range		
		BJ	B	±10%	20°C	-25 to +85°C		
			X5R	±15%	25°C	-55 to +85°C		
		B7	X7R	±15%	25°C	-55 to +125°C		
		C6	XS	±22%	25°C	-55 to +105°C		
		C7	X7S	±22%	25°C	-55 to +125°C		
		LD(※)	X5R	±15%	25°C	-55 to +85°C		
		Note : ※LD Low distortion high value multilayer ceramic capacitor						
		Class 1 Capacitance at 20°C and 85°C shall be measured in thermal equilibrium, and the temperature characteristic shall be calculated from the following equation.						
		$\frac{(C_{85} - C_{20})}{C_{20} \times \Delta T} \times 10^6 (\text{ppm}/^\circ\text{C}) \quad \Delta T = 65$						
Class 2 Capacitance at each step shall be measured in thermal equilibrium, and the temperature characteristic shall be calculated from the following equation.								
	Step	B	X5R, X7R, X6S, X7S					
	1	Minimum operating temperature						
	2	20°C	25°C					
	3	Maximum operating temperature						
	$\frac{(C - C_2)}{C_2} \times 100 (\%)$		C : Capacitance in Step 1 or Step 3 C ₂ : Capacitance in Step 2					

▶ This catalog contains the typical specification only due to the limitation of space. When you consider the purchase of our products, please check our specification. For details of each product (characteristics graph, reliability information, precautions for use, and so on), see our Web site (<http://www.ty-top.com/>).

9. Deflection

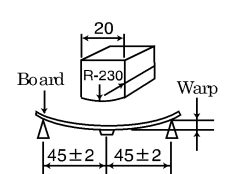
Specified Value	Temperature Compensating(Class1)	Standard	Appearance : No abnormality Capacitance change : Within $\pm 5\%$ or ± 0.5 pF, whichever is larger.																		
		High Frequency Type	Appearance : No abnormality Capacitance change : Within ± 0.5 pF																		
	High Permittivity (Class2)		Appearance : No abnormality Capacitance change : Within $\pm 12.5\%$																		
Test Methods and Remarks	<table border="1" style="width: 100%; border-collapse: collapse;"> <tr> <td></td> <td colspan="2" style="text-align: center;">Multilayer Ceramic Capacitors</td> </tr> <tr> <td></td> <td style="text-align: center;">021, 042, 063, *105 Type</td> <td style="text-align: center;">The other types</td> </tr> <tr> <td style="text-align: center;">Board</td> <td colspan="2" style="text-align: center;">Glass epoxy-resin substrate</td> </tr> <tr> <td style="text-align: center;">Thickness</td> <td style="text-align: center;">0.8mm</td> <td style="text-align: center;">1.6mm</td> </tr> <tr> <td style="text-align: center;">Warp</td> <td colspan="2" style="text-align: center;">1mm</td> </tr> <tr> <td style="text-align: center;">Duration</td> <td colspan="2" style="text-align: center;">10 sec.</td> </tr> </table> <p style="text-align: center; font-size: small;">*105 Type thickness, C: 0.2mm ,P: 0.3mm.</p>			Multilayer Ceramic Capacitors			021, 042, 063, *105 Type	The other types	Board	Glass epoxy-resin substrate		Thickness	0.8mm	1.6mm	Warp	1mm		Duration	10 sec.		 <p style="text-align: center; font-size: x-small;">(Unit: mm)</p> <p style="text-align: center;">Capacitance measurement shall be conducted with the board bent</p>
		Multilayer Ceramic Capacitors																			
	021, 042, 063, *105 Type	The other types																			
Board	Glass epoxy-resin substrate																				
Thickness	0.8mm	1.6mm																			
Warp	1mm																				
Duration	10 sec.																				

10. Body Strength

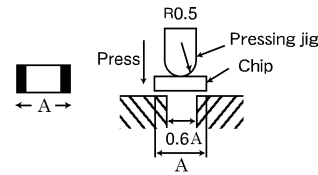
Specified Value	Temperature Compensating(Class1)	Standard	-
		High Frequency Type	No mechanical damage.
	High Permittivity (Class2)		-
Test Methods and Remarks	High Frequency 105Type Applied force : 5N Duration : 10 sec.		

11. Adhesive Strength of Terminal Electrodes

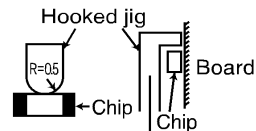
Specified Value	Temperature Compensating(Class1)	Standard	No terminal separation or its indication.												
		High Frequency Type													
	High Permittivity (Class2)														
Test Methods and Remarks	<table border="1" style="width: 100%; border-collapse: collapse;"> <tr> <td></td> <td colspan="2" style="text-align: center;">Multilayer Ceramic Capacitors</td> </tr> <tr> <td></td> <td style="text-align: center;">021, 042, 063 Type</td> <td style="text-align: center;">105 Type or more</td> </tr> <tr> <td style="text-align: center;">Applied force</td> <td style="text-align: center;">2N</td> <td style="text-align: center;">5N</td> </tr> <tr> <td style="text-align: center;">Duration</td> <td colspan="2" style="text-align: center;">30±5 sec.</td> </tr> </table>			Multilayer Ceramic Capacitors			021, 042, 063 Type	105 Type or more	Applied force	2N	5N	Duration	30±5 sec.		
		Multilayer Ceramic Capacitors													
		021, 042, 063 Type	105 Type or more												
Applied force	2N	5N													
Duration	30±5 sec.														

12. Solderability

Specified Value	Temperature Compensating(Class1)	Standard	At least 95% of terminal electrode is covered by new solder.
		High Frequency Type	
	High Permittivity (Class2)		
Test Methods and Remarks			
		Eutectic solder	Lead-free solder
	Solder type	H60A or H63A	Sn-3.0Ag-0.5Cu
	Solder temperature	230±5°C	245±3°C
	Duration	4±1 sec.	

▶ This catalog contains the typical specification only due to the limitation of space. When you consider the purchase of our products, please check our specification. For details of each product (characteristics graph, reliability information, precautions for use, and so on), see our Web site (<http://www.ty-top.com/>).

13. Resistance to Soldering

Specified Value	Temperature Compensating (Class1)	Standard	Appearance : No abnormality Capacitance change : Within $\pm 2.5\%$ or $\pm 0.25\text{pF}$, whichever is larger. Q : Initial value Insulation resistance : Initial value Withstanding voltage (between terminals) : No abnormality	
		High Frequency Type	Appearance : No abnormality Capacitance change : Within $\pm 2.5\%$ Q : Initial value Insulation resistance : Initial value Withstanding voltage (between terminals) : No abnormality	
	High Permittivity (Class2) Note 1		Appearance : No abnormality Capacitance change : Within $\pm 7.5\%$ Dissipation factor : Initial value Insulation resistance : Initial value Withstanding voltage (between terminals) : No abnormality	
Test Methods and Remarks	Class 1			
		021, 042, 063 Type	105 Type	
	Preconditioning	None		
	Preheating	150°C, 1 to 2 min.	80 to 100°C, 2 to 5 min. 150 to 200°C, 2 to 5 min.	
	Solder temp.	270 \pm 5°C		
	Duration	3 \pm 0.5 sec.		
	Recovery	6 to 24 hrs (Standard condition) Note 5		
	Class 2			
		021, 042, 063 Type	105, 107, 212 Type	316, 325, 432 Type
	Preconditioning	Thermal treatment (at 150°C for 1 hr) Note 2		
	Preheating	150°C, 1 to 2 min.	80 to 100°C, 2 to 5 min. 150 to 200°C, 2 to 5 min.	80 to 100°C, 5 to 10 min. 150 to 200°C, 5 to 10 min.
	Solder temp.	270 \pm 5°C		
	Duration	3 \pm 0.5 sec.		
	Recovery	24 \pm 2 hrs (Standard condition) Note 5		

14. Temperature Cycle (Thermal Shock)

Specified Value	Temperature Compensating (Class1)	Standard	Appearance : No abnormality Capacitance change : Within $\pm 2.5\%$ or $\pm 0.25\text{pF}$, whichever is larger. Q : Initial value Insulation resistance : Initial value Withstanding voltage (between terminals) : No abnormality															
		High Frequency Type	Appearance : No abnormality Capacitance change : Within $\pm 0.25\text{pF}$ Q : Initial value Insulation resistance : Initial value Withstanding voltage (between terminals) : No abnormality															
	High Permittivity (Class2) Note 1		Appearance : No abnormality Capacitance change : Within $\pm 7.5\%$ Dissipation factor : Initial value Insulation resistance : Initial value Withstanding voltage (between terminals) : No abnormality															
Test Methods and Remarks	Class 1		Class 2															
	Preconditioning	None	Thermal treatment (at 150°C for 1 hr) Note 2															
	1 cycle	<table border="1"> <thead> <tr> <th>Step</th> <th>Temperature (°C)</th> <th>Time (min.)</th> </tr> </thead> <tbody> <tr> <td>1</td> <td>Minimum operating temperature</td> <td>30\pm3</td> </tr> <tr> <td>2</td> <td>Normal temperature</td> <td>2 to 3</td> </tr> <tr> <td>3</td> <td>Maximum operating temperature</td> <td>30\pm3</td> </tr> <tr> <td>4</td> <td>Normal temperature</td> <td>2 to 3</td> </tr> </tbody> </table>		Step	Temperature (°C)	Time (min.)	1	Minimum operating temperature	30 \pm 3	2	Normal temperature	2 to 3	3	Maximum operating temperature	30 \pm 3	4	Normal temperature	2 to 3
		Step	Temperature (°C)	Time (min.)														
		1	Minimum operating temperature	30 \pm 3														
		2	Normal temperature	2 to 3														
3	Maximum operating temperature	30 \pm 3																
4	Normal temperature	2 to 3																
Number of cycles	5 times																	
Recovery	6 to 24 hrs (Standard condition) Note 5	24 \pm 2 hrs (Standard condition) Note 5																

▶ This catalog contains the typical specification only due to the limitation of space. When you consider the purchase of our products, please check our specification. For details of each product (characteristics graph, reliability information, precautions for use, and so on), see our Web site (<http://www.ty-top.com/>).

15. Humidity (Steady State)

Specified Value	Temperature Compensating (Class1)	Standard	Appearance : No abnormality Capacitance change : Within $\pm 5\%$ or $\pm 0.5\text{pF}$, whichever is larger. Q : $C < 10\text{pF} : Q \geq 200 + 10C$ $10 \leq C < 30\text{pF} : Q \geq 275 + 2.5C$ $C \geq 30\text{pF} : Q \geq 350 (C: \text{Nominal capacitance})$ Insulation resistance : 1000 M Ω min.	
		High Frequency Type	Appearance : No abnormality Capacitance change : Within $\pm 0.5\text{pF}$, Insulation resistance : 1000 M Ω min.	
	High Permittivity (Class2) Note 1		Appearance : No abnormality Capacitance change : Within $\pm 12.5\%$ Dissipation factor : 5.0% max. Insulation resistance : 50 M Ω μF or 1000 M Ω whichever is smaller.	
Test Methods and Remarks		Class 1		Class 2
		Standard	High Frequency Type	All items
	Preconditioning	None		Thermal treatment (at 150°C for 1 hr) Note 2
	Temperature	40 \pm 2°C	60 \pm 2°C	40 \pm 2°C
	Humidity	90 to 95%RH		90 to 95%RH
	Duration	500+24/-0 hrs		500+24/-0 hrs
	Recovery	6 to 24 hrs (Standard condition) Note 5		24 \pm 2 hrs (Standard condition) Note 5

16. Humidity Loading

Specified Value	Temperature Compensating (Class1)	Standard	Appearance : No abnormality Capacitance change : Within $\pm 7.5\%$ or $\pm 0.75\text{pF}$, whichever is larger. Q : $C < 30\text{pF} : Q \geq 100 + 10C/3$ $C \geq 30\text{pF} : Q \geq 200 (C: \text{Nominal capacitance})$ Insulation resistance : 500 M Ω min.	
		High Frequency Type	Appearance : No abnormality Capacitance change : $C \leq 2\text{pF} : \text{Within } \pm 0.4 \text{ pF}$ $C > 2\text{pF} : \text{Within } \pm 0.75 \text{ pF}$ (C:Nominal capacitance) Insulation resistance : 500 M Ω min.	
	High Permittivity (Class2) Note 1		Appearance : No abnormality Capacitance change : Within $\pm 12.5\%$ Dissipation factor : 5.0% max. Insulation resistance : 25 M Ω μF or 500 M Ω whichever is smaller.	
Test Methods and Remarks		Class 1		Class 2
		Standard	High Frequency Type	All items
	Preconditioning	None		Voltage treatment (Rated voltage are applied for 1 hour at 40°C) Note 3
	Temperature	40 \pm 2°C	60 \pm 2°C	40 \pm 2°C
	Humidity	90 to 95%RH		90 to 95%RH
	Duration	500+24/-0 hrs		500+24/-0 hrs
	Applied voltage	Rated voltage		Rated voltage
	Charge/discharge current	50mA max.		50mA max.
Recovery	6 to 24 hrs (Standard condition) Note 5		24 \pm 2 hrs (Standard condition) Note 5	

► This catalog contains the typical specification only due to the limitation of space. When you consider the purchase of our products, please check our specification.
For details of each product (characteristics graph, reliability information, precautions for use, and so on), see our Web site (<http://www.ty-top.com/>).

17. High Temperature Loading

Specified Value	Temperature Compensating (Class1)	Standard	Appearance : No abnormality Capacitance change : Within $\pm 3\%$ or $\pm 0.3\text{pF}$, whichever is larger. Q : $C < 10\text{pF}$: $Q \geq 200 + 10C$ $10 \leq C < 30\text{pF}$: $Q \geq 275 + 2.5C$ $C \geq 30\text{pF}$: $Q \geq 350$ (C: Nominal capacitance) Insulation resistance : 1000 M Ω min.			
		High Frequency Type	Appearance : No abnormality Capacitance change : Within $\pm 3\%$ or $\pm 0.3\text{pF}$, whichever is larger. Insulation resistance : 1000 M Ω min.			
	High Permittivity (Class2) Note 1		Appearance : No abnormality Capacitance change : Within $\pm 12.5\%$ Dissipation factor : 5.0% max. Insulation resistance : 50 M Ω μF or 1000 M Ω whichever is smaller.			
Test Methods and Remarks		Class 1		Class 2		
		Standard	High Frequency Type	BJ, LD(※)	C6	B7, C7
	Preconditioning	None		Voltage treatment (Twice the rated voltage shall be applied for 1 hour at 85°C, 105°C or 125°C) Note 3, 4		
	Temperature	Maximum operating temperature		Maximum operating temperature		
	Duration	1000 + 48 / - 0 hrs		1000 + 48 / - 0 hrs		
	Applied voltage	Rated voltage $\times 2$ Note 4		Rated voltage $\times 2$ Note 4		
	Charge/discharge current	50mA max.		50mA max.		
	Recovery	6 to 24hr (Standard condition) Note 5		24 \pm 2 hrs (Standard condition) Note 5		
Note: ※LD Low distortion high value multilayer ceramic capacitor						

Note 1 The figures indicate typical specifications. Please refer to individual specifications in detail.

Note 2 Thermal treatment : Initial value shall be measured after test sample is heat-treated at 150 + 0 / - 10°C for an hour and kept at room temperature for 24 \pm 2 hours.

Note 3 Voltage treatment : Initial value shall be measured after test sample is voltage-treated for an hour at both the temperature and voltage specified in the test conditions, and kept at room temperature for 24 \pm 2 hours.

Note 4 150% of rated voltage is applicable to some items. Please refer to their specifications for further information.

Note 5 Standard condition: Temperature: 5 to 35°C, Relative humidity: 45 to 85 % RH, Air pressure: 86 to 106kPa When there are questions concerning measurement results, in order to provide correlation data, the test shall be conducted under the following condition.
Temperature: 20 \pm 2°C, Relative humidity: 60 to 70 % RH, Air pressure: 86 to 106kPa Unless otherwise specified, all the tests are conducted under the "standard condition".

Precautions on the use of Multilayer Ceramic Capacitors

PRECAUTIONS

1. Circuit Design

- Precautions**
- ◆ Verification of operating environment, electrical rating and performance
 1. A malfunction of equipment in fields such as medical, aerospace, nuclear control, etc. may cause serious harm to human life or have severe social ramifications.
Therefore, any capacitors to be used in such equipment may require higher safety and reliability, and shall be clearly differentiated from them used in general purpose applications.
 - ◆ Operating Voltage (Verification of Rated voltage)
 1. The operating voltage for capacitors must always be their rated voltage or less.
If an AC voltage is loaded on a DC voltage, the sum of the two peak voltages shall be the rated voltage or less.
For a circuit where an AC or a pulse voltage may be used, the sum of their peak voltages shall also be the rated voltage or less.
 2. Even if an applied voltage is the rated voltage or less reliability of capacitors may be deteriorated in case that either a high frequency AC voltage or a pulse voltage having rapid rise time is used in a circuit.

2. PCB Design

- Precautions**
- ◆ Pattern configurations (Design of Land-patterns)
 1. When capacitors are mounted on PCBs, the amount of solder used (size of fillet) can directly affect the capacitor performance.
Therefore, the following items must be carefully considered in the design of land patterns:
 - (1) Excessive solder applied can cause mechanical stresses which lead to chip breaking or cracking. Therefore, please consider appropriate land-patterns for proper amount of solder.
 - (2) When more than one component are jointly soldered onto the same land, each component's soldering point shall be separated by solder-resist.
 - ◆ Pattern configurations (Capacitor layout on PCBs)

After capacitors are mounted on boards, they can be subjected to mechanical stresses in subsequent manufacturing processes (PCB cutting, board inspection, mounting of additional parts, assembly into the chassis, wave soldering of the boards, etc.). For this reason, land pattern configurations and positions of capacitors shall be carefully considered to minimize stresses.

- ◆ Pattern configurations (Design of Land-patterns)
The following diagrams and tables show some examples of recommended land patterns to prevent excessive solder amounts.

(1) Recommended land dimensions for typical chip capacitors

- Multilayer Ceramic Capacitors : Recommended land dimensions (unit: mm)

		Wave-soldering			
Type		107	212	316	325
Size	L	1.6	2.0	3.2	3.2
	W	0.8	1.25	1.6	2.5
A		0.8 to 1.0	1.0 to 1.4	1.8 to 2.5	1.8 to 2.5
B		0.5 to 0.8	0.8 to 1.5	0.8 to 1.7	0.8 to 1.7
C		0.6 to 0.8	0.9 to 1.2	1.2 to 1.6	1.8 to 2.5

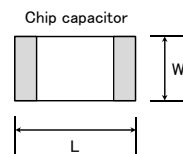
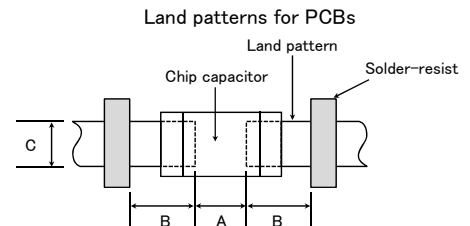

		Reflow-soldering								
Type		021	042	063	105	107	212	316	325	432
Size	L	0.25	0.4	0.6	1.0	1.6	2.0	3.2	3.2	4.5
	W	0.125	0.2	0.3	0.5	0.8	1.25	1.6	2.5	3.2
A		0.095~0.135	0.15~0.25	0.20~0.30	0.45~0.55	0.8~1.0	0.8~1.2	1.8~2.5	1.8~2.5	2.5~3.5
B		0.085~0.125	0.15~0.20	0.20~0.30	0.40~0.50	0.6~0.8	0.8~1.2	1.0~1.5	1.0~1.5	1.5~1.8
C		0.110~0.150	0.15~0.30	0.25~0.40	0.45~0.55	0.6~0.8	0.9~1.6	1.2~2.0	1.8~3.2	2.3~3.5

Note: Recommended land size might be different according to the allowance of the size of the product.

- LWDC: Recommended land dimensions for reflow-soldering (unit: mm)

Type		105	107	212
Size	L	0.52	0.8	1.25
	W	1.0	1.6	2.0
A		0.18~0.22	0.25~0.3	0.5~0.7
B		0.2~0.25	0.3~0.4	0.4~0.5
C		0.9~1.1	1.5~1.7	1.9~2.1



Technical considerations

(2) Examples of good and bad solder application

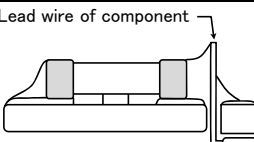
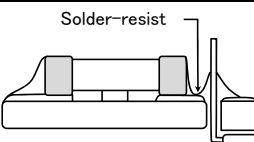
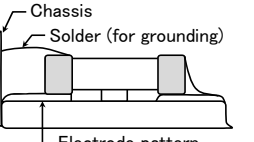
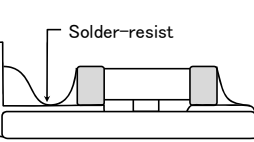
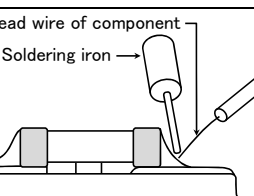
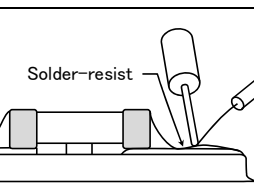
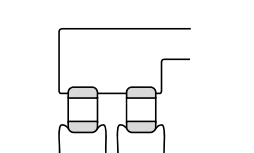
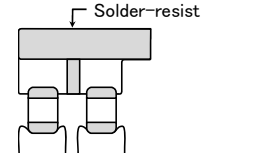
Item	Not recommended	Recommended
Mixed mounting of SMD and leaded components		
Component placement close to the chassis		
Hand-soldering of leaded components near mounted components		
Horizontal component placement		

◆ Pattern configurations (Capacitor layout on PCBs)

1-1. The following is examples of good and bad capacitor layouts ; capacitors shall be located to minimize any possible mechanical stresses from board warp or deflection.

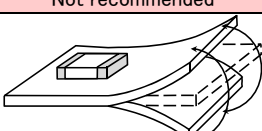
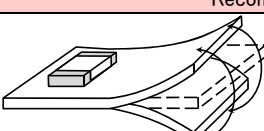
Items	Not recommended	Recommended
Deflection of board		

Place the product at a right angle to the direction of the anticipated mechanical stress.

1-2. The amount of mechanical stresses given will vary depending on capacitor layout. Please refer to diagram below.

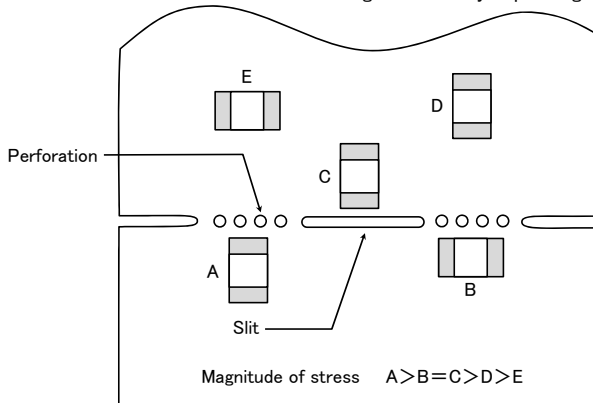

1-3. When PCB is split, the amount of mechanical stress on the capacitors can vary according to the method used. The following methods are listed in order from least stressful to most stressful: push-back, slit, V-grooving, and perforation. Thus, please consider the PCB, split methods as well as chip location.

3. Mounting

Precautions

◆ Adjustment of mounting machine

- When capacitors are mounted on PCB, excessive impact load shall not be imposed on them.
- Maintenance and inspection of mounting machines shall be conducted periodically.

◆ Selection of Adhesives

- When chips are attached on PCBs with adhesives prior to soldering, it may cause capacitor characteristics degradation unless the following factors are appropriately checked : size of land patterns, type of adhesive, amount applied, hardening temperature and hardening period. Therefore, please contact us for further information.

◆Adjustment of mounting machine

1. When the bottom dead center of a pick-up nozzle is too low, excessive force is imposed on capacitors and causes damages. To avoid this, the following points shall be considerable.

- (1) The bottom dead center of the pick-up nozzle shall be adjusted to the surface level of PCB without the board deflection.
- (2) The pressure of nozzle shall be adjusted between 1 and 3 N static loads.
- (3) To reduce the amount of deflection of the board caused by impact of the pick-up nozzle, supporting pins or back-up pins shall be used on the other side of the PCB. The following diagrams show some typical examples of good and bad pick-up nozzle placement:

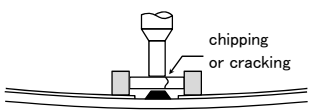
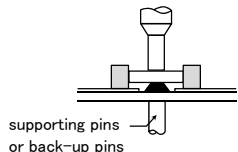
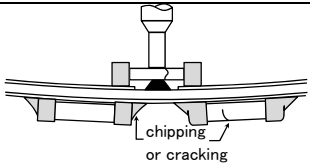
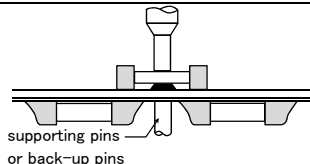
Item	Improper method	Proper method
Single-sided mounting		
Double-sided mounting		

Technical considerations

2. As the alignment pin is worn out, adjustment of the nozzle height can cause chipping or cracking of capacitors because of mechanical impact on the capacitors.

To avoid this, the monitoring of the width between the alignment pins in the stopped position, maintenance, check and replacement of the pin shall be conducted periodically.

◆Selection of Adhesives

Some adhesives may cause IR deterioration. The different shrinkage percentage of between the adhesive and the capacitors may result in stresses on the capacitors and lead to cracking. Moreover, too little or too much adhesive applied to the board may adversely affect components. Therefore, the following precautions shall be noted in the application of adhesives.

(1) Required adhesive characteristics

- a. The adhesive shall be strong enough to hold parts on the board during the mounting & solder process.
- b. The adhesive shall have sufficient strength at high temperatures.
- c. The adhesive shall have good coating and thickness consistency.
- d. The adhesive shall be used during its prescribed shelf life.
- e. The adhesive shall harden rapidly.
- f. The adhesive shall have corrosion resistance.
- g. The adhesive shall have excellent insulation characteristics.
- h. The adhesive shall have no emission of toxic gasses and no effect on the human body.

(2) The recommended amount of adhesives is as follows;

[Recommended condition]

Figure	212/316 case sizes as examples
a	0.3mm min
b	100 to 120 μm
c	Adhesives shall not contact land

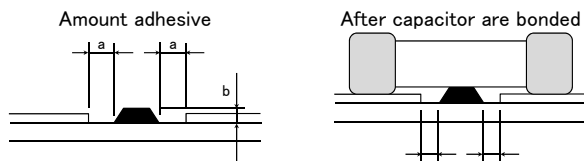

4. Soldering

◆Selection of Flux

Since flux may have a significant effect on the performance of capacitors, it is necessary to verify the following conditions prior to use;

- (1) Flux used shall be less than or equal to 0.1 wt% (in Cl equivalent) of halogenated content. Flux having a strong acidity content shall not be applied.
- (2) When shall capacitors are soldered on boards, the amount of flux applied shall be controlled at the optimum level.
- (3) When water-soluble flux is used, special care shall be taken to properly clean the boards.

Precautions

◆Soldering

Temperature, time, amount of solder, etc. shall be set in accordance with their recommended conditions.

Sn-Zn solder paste can adversely affect MLCC reliability.

Please contact us prior to usage of Sn-Zn solder.

Technical considerations

◆Selection of Flux

1-1. When too much halogenated substance (Chlorine, etc.) content is used to activate flux, or highly acidic flux is used, it may lead to corrosion of terminal electrodes or degradation of insulation resistance on the surfaces of the capacitors.

1-2. Flux is used to increase solderability in wave soldering. However if too much flux is applied, a large amount of flux gas may be emitted and may adversely affect the solderability. To minimize the amount of flux applied, it is recommended to use a flux-bubbling system.

1-3. Since the residue of water-soluble flux is easily dissolved in moisture in the air, the residues on the surfaces of capacitors in high humidity conditions may cause a degradation of insulation resistance and reliability of the capacitors. Therefore, the cleaning methods and the capability of the machines used shall also be considered carefully when water-soluble flux is used.

▶ This catalog contains the typical specification only due to the limitation of space. When you consider the purchase of our products, please check our specification. For details of each product (characteristics graph, reliability information, precautions for use, and so on), see our Web site (<http://www.ty-top.com/>).

◆Soldering

- Ceramic chip capacitors are susceptible to thermal shock when exposed to rapid or concentrated heating or rapid cooling.
- Therefore, the soldering must be conducted with great care so as to prevent malfunction of the components due to excessive thermal shock.
- Preheating : Capacitors shall be preheated sufficiently, and the temperature difference between the capacitors and solder shall be within 130°C.
- Cooling : The temperature difference between the capacitors and cleaning process shall not be greater than 100°C.

[Reflow soldering]

【Recommended conditions for eutectic soldering】

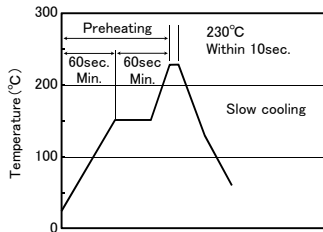

【Recommended condition for Pb-free soldering】

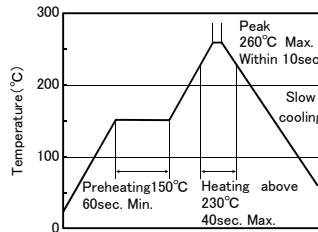

Caution

- ①The ideal condition is to have solder mass(fillet) controlled to 1/2 to 1/3 of the thickness of a capacitor.
- ②Because excessive dwell times can adversely affect solderability, soldering duration shall be kept as close to recommended times as possible. soldering for 2 times.

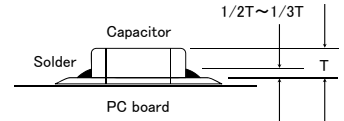

[Wave soldering]

【Recommended conditions for eutectic soldering】

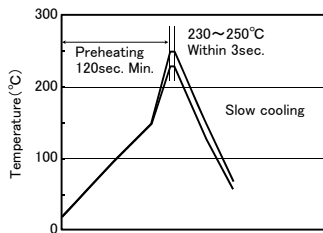

【Recommended condition for Pb-free soldering】

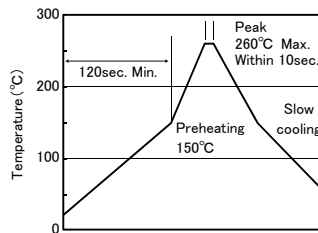

Caution

- ①Wave soldering must not be applied to capacitors designated as for reflow soldering only. soldering for 1 times.

[Hand soldering]

【Recommended conditions for eutectic soldering】

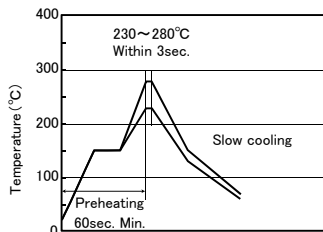

【Recommended condition for Pb-free soldering】

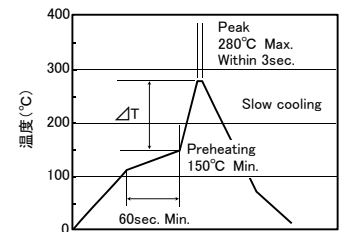
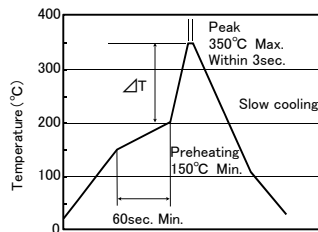

	ΔT
316type or less	$\Delta T \leq 150^{\circ}\text{C}$

	ΔT
325type or more	$\Delta T \leq 130^{\circ}\text{C}$

Caution

- ①Use a 50W soldering iron with a maximum tip diameter of 1.0 mm.
- ②The soldering iron shall not directly touch capacitors. soldering for 1 times.

5. Cleaning	
Precautions	<p>◆Cleaning conditions</p> <ol style="list-style-type: none"> When PCBs are cleaned after capacitors mounting, please select the appropriate cleaning solution in accordance with the intended use of the cleaning. (e.g. to remove soldering flux or other materials from the production process.) Cleaning condition shall be determined after it is verified by using actual cleaning machine that the cleaning process does not affect capacitor's characteristics.
Technical considerations	<ol style="list-style-type: none"> The use of inappropriate cleaning solutions can cause foreign substances such as flux residue to adhere to capacitors or deteriorate their outer coating, resulting in a degradation of the capacitor's electrical properties (especially insulation resistance). Inappropriate cleaning conditions (insufficient or excessive cleaning) may adversely affect the performance of the capacitors. In the case of ultrasonic cleaning, too much power output can cause excessive vibration of PCBs which may lead to the cracking of capacitors or the soldered portion, or decrease the terminal electrodes' strength. Therefore, the following conditions shall be carefully checked: Ultrasonic output : 20 W/ℓ or less Ultrasonic frequency : 40 kHz or less Ultrasonic washing period : 5 min. or less
6. Resin coating and mold	
Precautions	<ol style="list-style-type: none"> With some type of resins, decomposition gas or chemical reaction vapor may remain inside the resin during the hardening period or while left under normal storage conditions resulting in the deterioration of the capacitor's performance. When a resin's hardening temperature is higher than capacitor's operating temperature, the stresses generated by the excessive heat may lead to damage or destruction of capacitors. The use of such resins, molding materials etc. is not recommended.
7. Handling	
Precautions	<p>◆Splitting of PCB</p> <ol style="list-style-type: none"> When PCBs are split after components mounting, care shall be taken so as not to give any stresses of deflection or twisting to the board. Board separation shall not be done manually, but by using the appropriate devices. <p>◆Mechanical considerations</p> <p>Be careful not to subject capacitors to excessive mechanical shocks.</p> <ol style="list-style-type: none"> If ceramic capacitors are dropped onto a floor or a hard surface, they shall not be used. Please be careful that the mounted components do not come in contact with or bump against other boards or components.
8. Storage conditions	
Precautions	<p>◆Storage</p> <ol style="list-style-type: none"> To maintain the solderability of terminal electrodes and to keep packaging materials in good condition, care must be taken to control temperature and humidity in the storage area. Humidity should especially be kept as low as possible. <ul style="list-style-type: none"> Recommended conditions Ambient temperature : Below 30°C Humidity : Below 70% RH The ambient temperature must be kept below 40°C. Even under ideal storage conditions, solderability of capacitor is deteriorated as time passes, so capacitors shall be used within 6 months from the time of delivery. <ul style="list-style-type: none"> Ceramic chip capacitors shall be kept where no chlorine or sulfur exists in the air. The capacitance values of high dielectric constant capacitors will gradually decrease with the passage of time, so care shall be taken to design circuits. Even if capacitance value decreases as time passes, it will get back to the initial value by a heat treatment at 150°C for 1hour.
Technical considerations	<p>If capacitors are stored in a high temperature and humidity environment, it might rapidly cause poor solderability due to terminal oxidation and quality loss of taping/packaging materials. For this reason, capacitors shall be used within 6 months from the time of delivery. If exceeding the above period, please check solderability before using the capacitors.</p>

※RCR-2335B (Safety Application Guide for fixed ceramic capacitors for use in electronic equipment) is published by JEITA.

Please check the guide regarding precautions for deflection test, soldering by spot heat, and so on.

X-ON Electronics

Largest Supplier of Electrical and Electronic Components

Click to view similar products for [Multilayer Ceramic Capacitors MLCC - SMD/SMT](#) category:

Click to view products by [Taiyo Yuden](#) manufacturer:

Other Similar products are found below :

[M39014/01-1467](#) [M39014/02-1218V](#) [M39014/02-1225V](#) [M39014/02-1262V](#) [M39014/22-0631](#) [1210J5000102JCT](#) [1210J2K00102KXT](#)
[1210J5000103KXT](#) [1210J5000223KXT](#) [D55342E07B379BR-TR](#) [D55342E07B523DR-T/R](#) [1812J1K00103KXT](#) [1812J1K00473KXT](#)
[1812J2K00680JCT](#) [1812J4K00102MXT](#) [1812J5000102JCT](#) [1812J5000103JCT](#) [1812J5000682JCT](#) [NIN-FB391JTRF](#) [NIN-FC2R7JTRF](#)
[NPIS27H102MTRF](#) [C1206C101J1GAC](#) [C1608C0G1E472JT000N](#) [C2012C0G2A472J](#) [2220J2K00101JCT](#) [KHC201E225M76N0T00](#)
[1812J1K00222JCT](#) [1812J2K00102KXT](#) [1812J2K00222KXT](#) [1812J2K00472KXT](#) [2-1622820-7-CUT-TAPE](#) [2220J3K00102KXT](#)
[2225J2500824KXT](#) [CCR07CG103KM](#) [CGA2B2C0G1H010C](#) [CGA2B2C0G1H040C](#) [CGA2B2C0G1H050C](#) [CGA2B2C0G1H060D](#)
[CGA2B2C0G1H070D](#) [CGA2B2C0G1H151J](#) [CGA2B2C0G1H1R5C](#) [CGA2B2C0G1H2R2C](#) [CGA2B2C0G1H3R3C](#) [CGA2B2C0G1H680J](#)
[CGA2B2C0G1H6R8D](#) [CGA2B2X8R1H221K](#) [CGA2B2X8R1H472K](#) [CGA3E1X7R1C474K](#) [CGA3E2C0G1H561JT0Y0N](#)
[CGA4J2X7R2A104K](#)