

STYLE	"A"	"B"
-X1	.120 [3.05]	.020 [.51]
-X3	.075 [1.91]	.016 [.41]

DO NOT SCALE FROM THIS PRINT

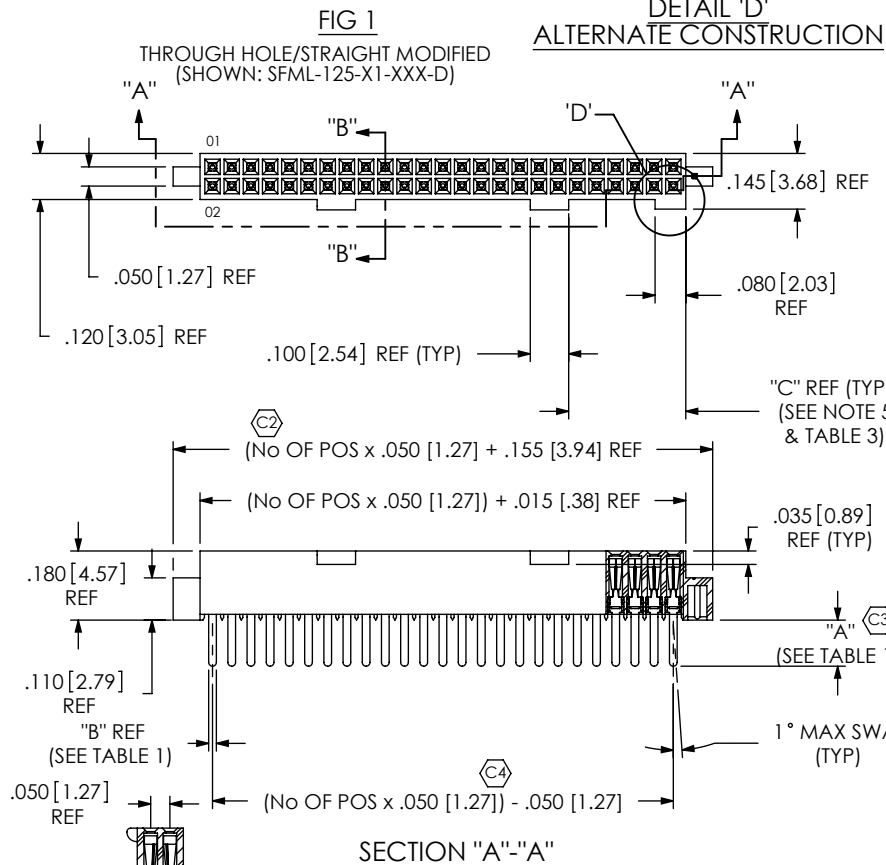

NO OF POS.	"C"
-05, -07	.080 [2.03]
-10 THRU -50	.305 [7.75]

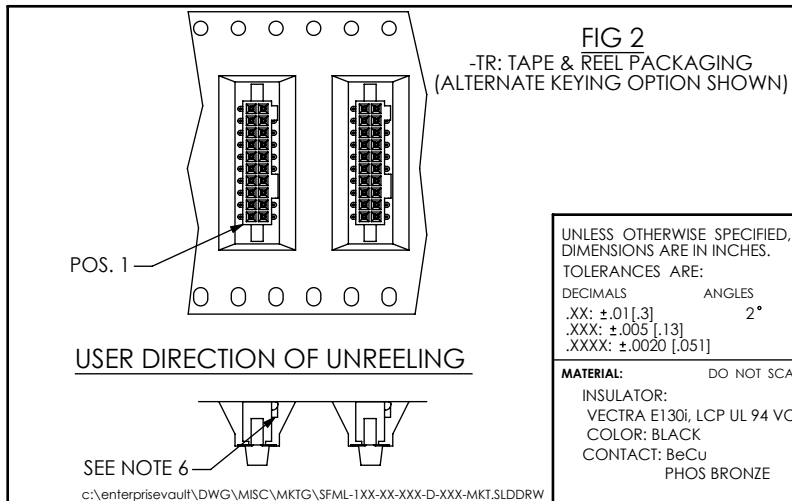
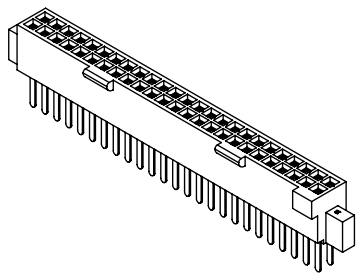

SFML-1XX-XX-XXX-D-XXX

AE NO OF POSITIONS
-05, -07, -08, -10 THRU -50
(PER ROW)

- LEAD STYLE**
- 01: THROUGH HOLE (USE C-44-01-XXX, SEE FIG 1, SHT 1)
 - 02: SURFACE MOUNT (USE C-44-02-XXX, SEE FIG 3, SHT 2)
 - 03: STRAIGHT MODIFIED (USE C-44-03-XXX, SEE FIG 1, SHT 1)
 - L1: THROUGH HOLE (LOW INSERTION) (USE C-61-01-XXX, SEE FIG 1, SHT 1)
 - L2: SURFACE MOUNT (LOW INSERTION) (USE C-61-02-XXX, SEE FIG 3, SHT 2)
 - L3: STRAIGHT MODIFIED (LOW INSERTION) (USE C-61-03-XXX, SEE FIG 1, SHT 1)
 - T1: THROUGH HOLE (PHOS BRONZE) (USE C-119-01-XXX, SEE FIG 1, SHT 1)
 - T2: SURFACE MOUNT (PHOS BRONZE) (USE C-119-02-XXX, SEE FIG 3, SHT 2)

- OPTIONS**
(LEAVE BLANK FOR STANDARD AND USE SFML-XX-D)
- A: ALIGNMENT PIN (USE SFML-XX-D-A) (SEE FIG 5, SHT 3)
 - LC: LOCKING CLIP (SEE FIG 7, SHT 3) (USE (2) LC-05-TM & SFML-XX-D) (SEE NOTE 9)
 - P: PICK & PLACE PAD (SEE FIG 6, SHT 3) (USE PPP-02) (NOT AVAILABLE IN 5 POS)
 - TR: TAPE & REEL PACKAGING (N/A with -X1 AND -X3 LEAD STYLE, SEE FIG 2, SHT 1)
 - K: POLYIMIDE FILM PAD (USE K-500-300) (SEE FIG. 4, SHT. 2)
 - SN: SOLDER NAIL (USE SFML-XX-D-SN & WT-27-01-T) (SEE FIG 8, SHT 4) (AVAILABLE ON -X2 LEAD STYLES ONLY)
 - SN2: SOLDER NAIL FOR .093 BOARD (USE SFML-XX-D-SN & WT-27-02-T) (SEE FIG 8, SHT 4) (ONLY AVAILABLE WITH -02, L2, AND T2 LEAD STYLE. NOT AVAILABLE WITH -A, -LC OPTIONS)
- ROW SPECIFICATION**
- D: DOUBLE ROW (USE SFML-XX-D-X)

- AE**
- PLATING SPECIFICATION**
- S: 30μ" SELECTIVE GOLD IN CONTACT AREA, MATTE TIN ON TAIL
 - F: 3μ" FLASH SELECTIVE GOLD IN CONTACT AREA, MATTE TIN ON TAIL
 - H: 30μ" HEAVY GOLD IN CONTACT AREA, 3μ" GOLD ON TAIL
 - L: 10μ" LIGHT SELECTIVE GOLD IN CONTACT AREA, MATTE TIN ON TAIL
 - STL: 30μ" SELECTIVE GOLD IN CONTACT AREA, TIN/LEAD (90/10+/-5%) TAIL (ONLY AVAILABLE ON -02 AND -L2 LEADSTYLES)
 - SM: 30μ" SELECTIVE GOLD IN CONTACT AREA, MATTE TIN ON TAIL
 - LM: 10μ" LIGHT SELECTIVE GOLD IN CONTACT AREA, MATTE TIN ON TAIL
 - FM: 3μ" FLASH SELECTIVE GOLD IN CONTACT AREA, MATTE TIN ON TAIL

NOTES:

1. **C** REPRESENTS A CRITICAL DIMENSION.
2. COPLANARITY: .004 [.10] FOR POS. 10 THRU 26
.006 [.15] FOR POS. 27 THRU 50
3. MINIMUM PUSHOUT FORCE: .5 LB.
4. MAXIMUM ALLOWABLE BOW: .002 INCH/INCH [MM/MM] AFTER ASSEMBLY.
5. POSITIONS -05 AND -07 WILL HAVE ONLY ONE CLIP AT DIMENSION SHOWN AND WILL NOT HAVE POLARIZATION NOTCH;
POSITIONS -10 THROUGH -24 WILL HAVE ONLY ONE CLIP AT DIMENSION SHOWN;
POSITIONS -25 THROUGH -34 WILL HAVE TWO CLIPS AT DIMENSION SHOWN;
POSITIONS -35 THROUGH -50 WILL HAVE THREE CLIPS: TWO AT DIMENSION SHOWN & ONE CENTERED ON INSULATOR.
6. SEE NOTCH FOR PROPER ORIENTATION.
7. PINS CAN BE ORIENTED IN ANY DIRECTION; BOTH ROWS MUST FACW SAME WAY.
8. MAXIMUM PIN HEIGHT VARIATION BETWEEN ANY TWO ROWS: .003[.08].
9. DUE TO THE HIGH AMOUNT OF INSERTION FORCE NEEDED, THE -LC OPTION IS NOT COMPATIBLE WITH AUTO PLACEMENT. SAMTEC RECOMMENDS MANUAL PLACEMENT FOR ALL ASSEMBLIES WITH THE -LC OPTION.
10. TUBE PARTS WITH NOTCH TOWARD ARROW.

UNLESS OTHERWISE SPECIFIED, DIMENSIONS ARE IN INCHES. TOLERANCES ARE:
DECIMALS ANGLES
.XX: ±.01 [.3] 2°
.XXX: ±.005 [.13]
.XXXX: ±.0020 [.051]

PROPRIETARY NOTE
THIS DOCUMENT CONTAINS INFORMATION CONFIDENTIAL AND PROPRIETARY TO SAMTEC, INC. AND SHALL NOT BE REPRODUCED OR TRANSFERRED TO OTHER DOCUMENTS OR DISCLOSED TO OTHERS OR USED FOR ANY PURPOSE OTHER THAN THAT WHICH IT WAS OBTAINED WITHOUT THE EXPRESSED WRITTEN CONSENT OF SAMTEC, INC.

520 PARK EAST BLVD, NEW ALBANY, IN 47150
PHONE: 812-944-6733 FAX: 812-948-5047
e-Mail: info@SAMTEC.com code: 53322

MATERIAL: INSULATOR: VECTRA E130i, LCP UL 94 VO COLOR: BLACK CONTACT: BeCu PHOS BRONZE	DO NOT SCALE DRAWING SHEET SCALE: 2:1	DESCRIPTION: .050 [1.27] x .050 [1.27] LOCKING SOCKET ASSEMBLY
		DWG. NO. SFML-1XX-XX-XXX-D-XXX
BY: BRATCHER 4/19/99		SHEET 1 OF 4

FIG 3
 -X2: SURFACE MOUNT
 (SAME AS FIG 1, UNLESS OTHERWISE STATED)

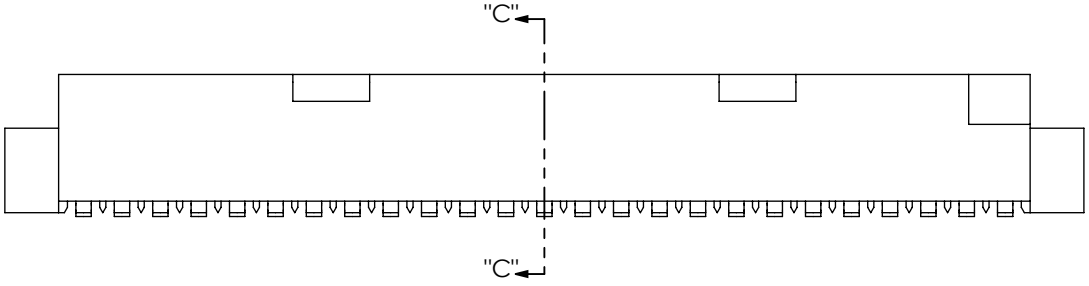
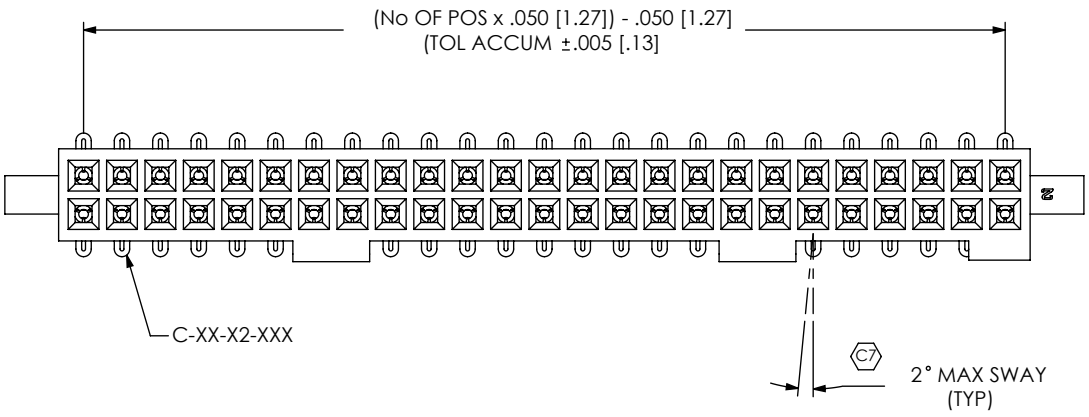
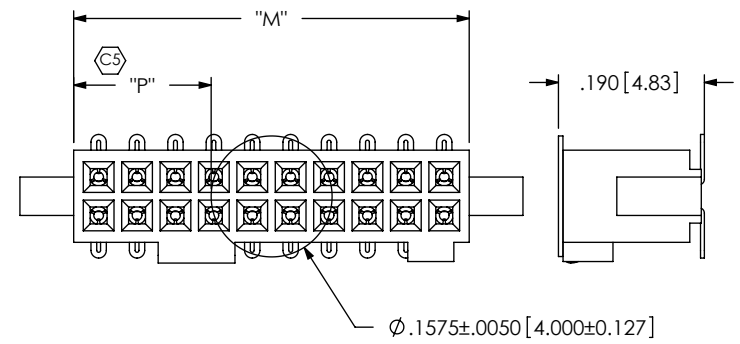
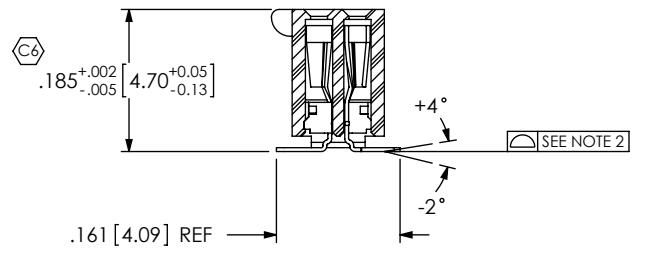

FIG 4
 -K: POLYIMIDE FILM PAD OPTION
 (SHOWN: SFML-110-X2-X-D-K)
 (ALTERNATE CONSTRUCTION SHOWN)



NOTE:
 "M" = USED MEASURED DIMENSION (REF)
 "P" = {"M" - .1575 [4.000]} / 2 ± .020 [.51]



SECTION "C"-"C"

c:\enterprisevault\DWG\MISC\MKTG\SFML-1XX-XX-XXX-D-XXX-MKT.SLDDRW

PROPRIETARY NOTE
 THIS DOCUMENT CONTAINS INFORMATION
 CONFIDENTIAL AND PROPRIETARY TO
 SAMTEC, INC. AND SHALL NOT BE REPRODUCED
 OR TRANSFERRED TO OTHER DOCUMENTS OR
 DISCLOSED TO OTHERS OR USED FOR ANY
 PURPOSE OTHER THAN THAT WHICH IT WAS
 OBTAINED WITHOUT THE EXPRESSED WRITTEN
 CONSENT OF SAMTEC, INC.

DO NOT SCALE DRAWING
 SHEET SCALE: 4:1



520 PARK EAST BLVD, NEW ALBANY, IN 47150
 PHONE: 812-944-6733 FAX: 812-948-5047
 e-Mail: info@SAMTEC.com code: 55322

DESCRIPTION:
 .050 [1.27] x .050 [1.27] LOCKING SOCKET ASSEMBLY

DWG. NO.
SFML-1XX-XX-XXX-D-XXX

BY: BRATCHER 4/19/99 SHEET 2 OF 4

FIG 5

-A: ALIGNMENT PIN OPTION
(SAME AS FIG 1, UNLESS OTHERWISE STATED)
(ALTERNATE CONSTRUCTION SHOWN)

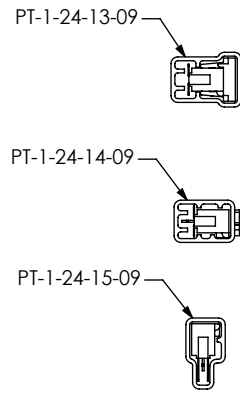
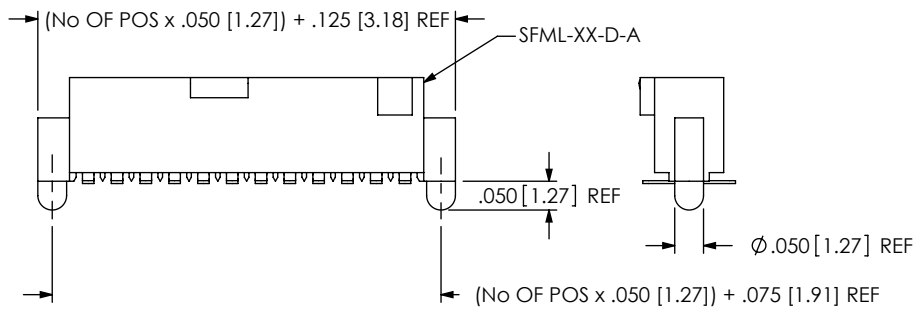

PACKAGE PARTS IN TUBES AS SHOWN
(SEE NOTE TO)

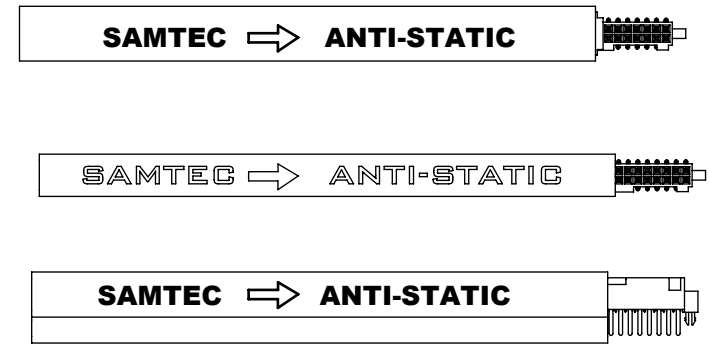
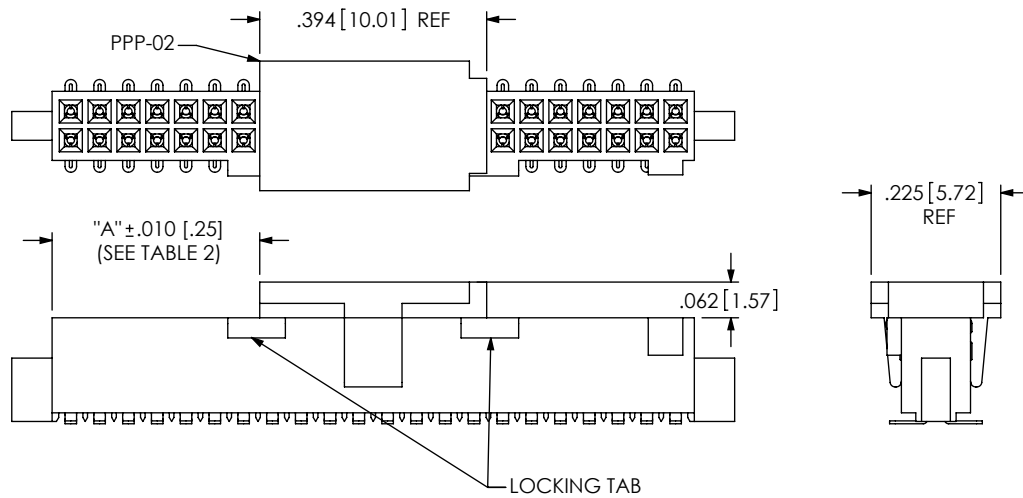

FIG 6

-P: PICK & PLACE PAD OPTION
(SAME AS FIG 1, UNLESS OTHERWISE STATED)
(ALTERNATE CONSTRUCTION SHOWN)



POS.	"A"
-35 AND ABOVE (ODD)	{(No OF POS x .050 [1.27]) / 2} -.2895 [7.353]
EVEN ABOVE -34	{(No OF POS x .050 [1.27]) / 2} -.3145 [7.989]
ODD ABOVE -19	{(No OF POS x .050 [1.27]) / 2} -.1895 [4.813]
EVEN ABOVE -18	{(No OF POS x .050 [1.27]) / 2} -.2145 [5.448]
-07	.065 [1.65] OVERHANG
-10	.086 [2.18]
-11	.136 [3.45]
-12	.186 [4.72]
-13	.236 [5.99]
-14	.286 [7.26]
-15	.086 [2.18]
-16	.136 [3.45]
-17	.186 [4.72]
-18	.236 [5.99]
-19	.286 [7.26]

LEAD STYLE	PACKAGING TUBE	PLUG
-X1-X, -X3-X (NO PAD)	PT-1-24-15-09	TP-24-02
-X1-X-P (W/ P&P PAD)	PT-1-24-01-09	TP-24
-X2-X (NO P&P PAD)	PT-1-24-14-09	TP-24-02
-X2-X-P, -X3-X-P (W/ P&P PAD)	PT-1-24-13-09	TP-24
-X1-K	PT-1-24-13-09	TP-24
-X2-K	PT-1-24-14-09	TP-24-02

FIG 7

-LC: LOCKING CLIP OPTION
(SAME AS FIG 1, UNLESS OTHERWISE STATED)
(ALTERNATE CONSTRUCTION SHOWN)

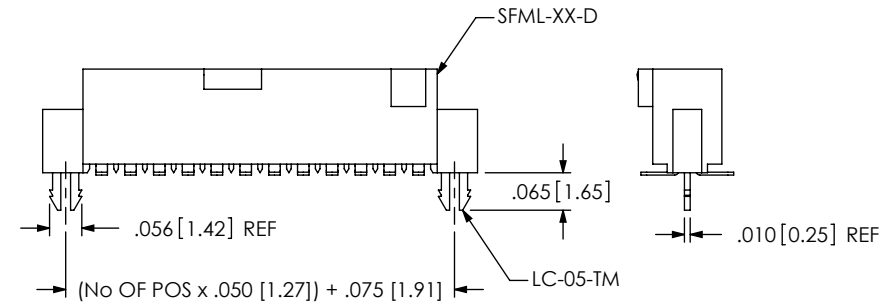

c:\enterprisevault\DWG\MISC\MKTG\SFML-1XX-XX-XXX-D-XXX-MKT.SLDDRW

PROPRIETARY NOTE
THIS DOCUMENT CONTAINS INFORMATION CONFIDENTIAL AND PROPRIETARY TO SAMTEC, INC. AND SHALL NOT BE REPRODUCED OR TRANSFERRED TO OTHER DOCUMENTS OR DISCLOSED TO OTHERS OR USED FOR ANY PURPOSE OTHER THAN THAT WHICH IT WAS OBTAINED WITHOUT THE EXPRESSED WRITTEN CONSENT OF SAMTEC, INC.

DO NOT SCALE DRAWING

SHEET SCALE: 3:1



520 PARK EAST BLVD. NEW ALBANY, IN 47150
PHONE: 812-944-6733 FAX: 812-948-5047
e-Mail: info@SAMTEC.com code: 55322

DESCRIPTION:
.050 [1.27] x .050 [1.27] LOCKING SOCKET ASSEMBLY

DWG. NO.
SFML-1XX-XX-XXX-D-XXX

BY: BRATCHER 4/19/99 SHEET 3 OF 4

FIG 8
 -SNX: SOLDER NAIL OPTION
 (SHOWN: SFML-125-02-XXX-D-SN
 (SAME AS FIG 1, UNLESS OTHERWISE STATED)
 (ONLY AVAILABLE ON -X2 LEAD STYLES)

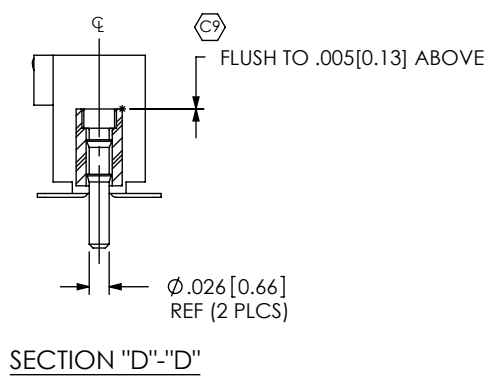
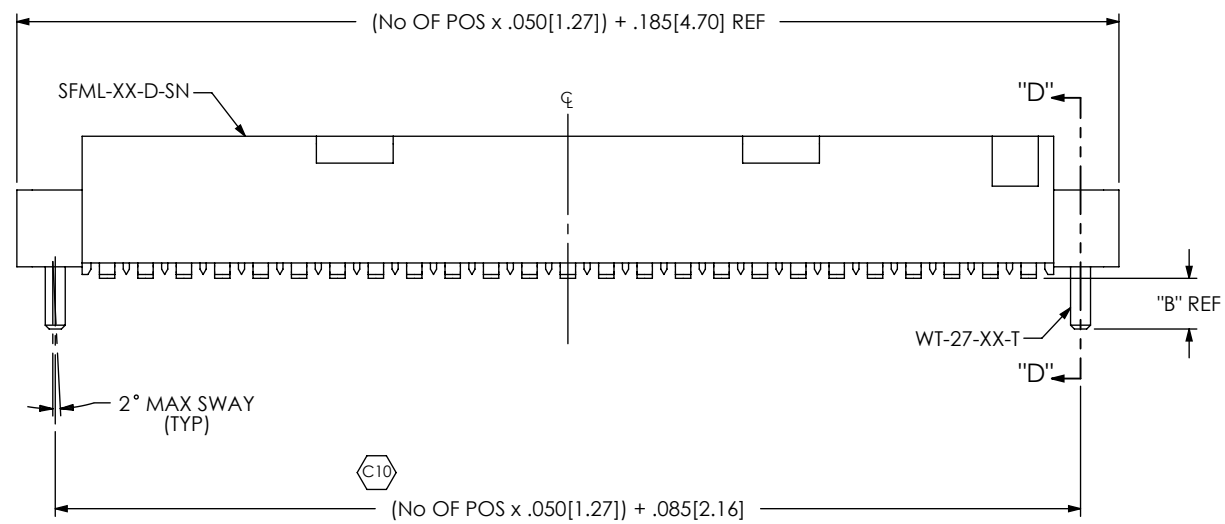



TABLE 3

OPTION	"B"
-SN	.066[1.68]
SN2	.101[1.80]

<p>PROPRIETARY NOTE THIS DOCUMENT CONTAINS INFORMATION CONFIDENTIAL AND PROPRIETARY TO SAMTEC, INC. AND SHALL NOT BE REPRODUCED OR TRANSFERRED TO OTHER DOCUMENTS OR DISCLOSED TO OTHERS OR USED FOR ANY PURPOSE OTHER THAN THAT WHICH IT WAS OBTAINED WITHOUT THE EXPRESSED WRITTEN CONSENT OF SAMTEC, INC.</p> <p>DO NOT SCALE DRAWING</p> <p>SHEET SCALE: 4:1</p>		
	<p>520 PARK EAST BLVD., NEW ALBANY, IN 47150 PHONE: 812-944-6733 FAX: 812-948-5047 e-Mail: info@SAMTEC.com code: 55322</p>	
	<p>DESCRIPTION: .050 [1.27] x .050 [1.27] LOCKING SOCKET ASSEMBLY</p>	
	<p>DWG. NO. SFML-1XX-XX-XXX-D-XXX</p>	
<p>BY: BRATCHER 4/19/99</p>	<p>SHEET 4 OF 4</p>	

X-ON Electronics

Largest Supplier of Electrical and Electronic Components

Click to view similar products for [Headers & Wire Housings](#) category:

Click to view products by [Samtec](#) manufacturer:

Other Similar products are found below :

[95000-104TRLF](#) [10135584-644402LF](#) [DF62W-EP2022PCA](#) [95000-106TRLF](#) [DF62W-2022SCA](#) [DF62W-EP2022PC](#) [2203348](#) [DF62W-2022SC](#) [1084018](#) [1029039](#) [1084017](#) [802-10-012-10-002000](#) [1112640](#) [1112639](#) [000-34000](#) [0009482033](#) [0009507031](#) [57102-S06-03LF](#) [57202-S52-04LF](#) [PCN6-15S-2.5E](#) [0039019024](#) [58102-G61-06LF](#) [582553-1](#) [0009485154](#) [0009508121](#) [0022285053](#) [0050291907](#) [018731A](#) [LY20-4P-DT1-P1E-BR](#) [02.125.8002.8](#) [60101931](#) [60598-1 \(Cut Strip\)](#) [M1625-3R/100](#) [61062-3](#) [61082-181009](#) [636-1427](#) [638009-1](#) [641938-9](#) [641991-4](#) [644168-1](#) [647662-1](#) [65039-019ELF](#) [65817-002LF](#) [65817-015LF](#) [65863-015LF](#) [66207-023LF](#) [67016-026LF](#) [67046-001LF](#) [67095-007LF](#) [67230-005LF](#)