

# SMT Gate Drive Transformers

>1500VDC Basic and Functional Insulation

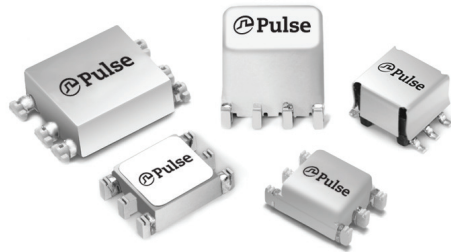

- >1500V<sub>DC</sub> isolation (380V<sub>rms</sub> continuous)
- Basic insulation (1.4mm creepage/clearance) and functional available
- Operating frequency: 50kHz and up

## Electrical Specifications @ 25°C - Operating Temperature -40°C to +130°C<sup>5</sup>

Part <sup>3,4</sup> Number	Turns Ratio	Pri-Sec Isolation	MAX <sup>1</sup> V* $\mu$ sec	Primary Inductance ( $\mu$ H MIN)	Leakage <sup>2</sup> Inductance ( $\mu$ H MAX)	DCR Primary ( $\Omega$ MAX)	DCR Secondary ( $\Omega$ MAX)	Package Size (L x W x H) (mm MAX)
<b>Functional Insulation</b>								
PE-68386NL	1:1	1500 Vdc	9.7	785	0.46	0.60	0.60	8.6 x 6.7 x 2.5
PO926NL	1:1:1	1500 Vdc	23.8	300	0.50	2.00	2.00	8.0 x 6.6 x 5.3
PO544NL	1:1:1	1500 Vdc	45.1	3300	0.80	1.25	1.25	9.0 x 8.6 x 7.6
PA0264NL	1:1:1	1000 Vrms	12.7	1140	0.65	0.75	0.75	8.6 x 6.7 x 3.6
PA1323NL	1:1	1500 Vrms	21.7	600	2.0	1.25	1.25	9.5 x 7.1 x 5.3
<b>Basic Insulation (1.4mm creepage and clearance between Primary and Secondary)</b>								
PA0173NL	1:1:1	1500 Vrms	17.2	980	0.75	0.62	0.88	11.8 x 8.8 x 4.0
PA0185NL	1:1	1500 Vrms	17.2	980	0.75	0.88	0.62	11.8 x 8.8 x 4.0
PA0184NL	1:1	1500 Vrms	27.2	1200	0.50	0.91	0.91	9.0 x 8.6 x 7.6
PA0297NL	2:1:1	1500 Vrms	27.2	1200	0.60	0.91	0.46	9.0 x 8.6 x 7.6
PA2777NL	1:1	1500 Vrms	9.3	335.2	0.36	0.70	0.70	7.1 x 6.1 x 5.5
PA0510NL	2.5:1:1	1500 Vrms	27.2	1200	0.68	0.91	0.380	9.0 x 8.6 x 7.6
PA3493NL	1.25:1	1650 Vrms	23	656	1.3	1.03	0.85	10.9 x 9.7 x 2.7

### Notes:

1. The Maximum volt- $\mu$ sec rating limits the peak flux density to 2200 Gauss when used in a unipolar drive application. For bi-polar drive applications, a maximum volt-sec of two times this rating is acceptable (ie: 2\* (volt\* $\mu$ sec rating) = (voltage applied to the primary) \* dutycycle / Frequency = V \* alpha / Freq\_Hz = V \*  $\mu$ sec
2. Leakage inductance is measured at primary terminals with all secondaries shorted.
3. Optional Tape & Reel packaging can be ordered by adding a "T" suffix to the part number (i.e. P0544NL becomes P0544NLT). Pulse complies to industry standard tape and reel specification EIA481.
4. The "NL" suffix indicates an RoHS-compliant part number.
5. The temperature of the component (ambient plus temperature rise) must be within the stated operating temperature range.
6. Continuous isolation voltage confirmed by 125°C/1000hrs accelerated aging with the bias voltage applied between primary and secondary windings

# SMT Gate Drive Transformers

>1500VDC Basic and Functional Insulation



## Mechanicals

## Schematics

### PE-68386NL

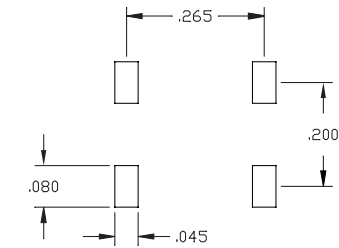
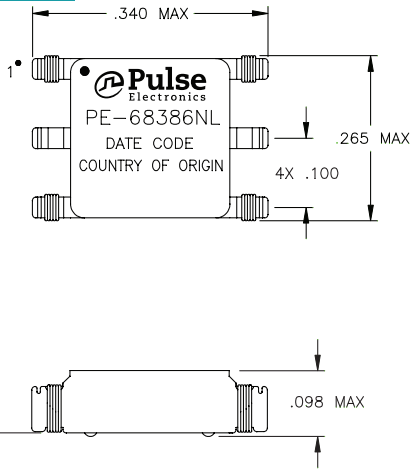

**SUGGESTED PAD LAYOUT**

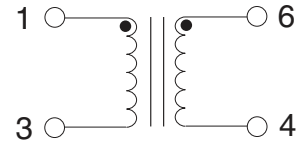

**Weight** .....0.28 grams  
**Tape & Reel** .....1500/reel  
**Tube** .....60/tube

**Dimension:**  $\frac{\text{Inches}}{\text{mm}}$   
 Unless otherwise specified, all tolerances are  $\pm \frac{.010}{0,25}$

### PA0264NL

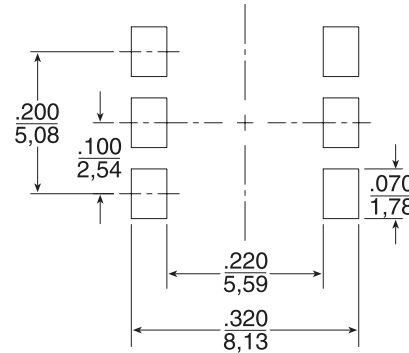
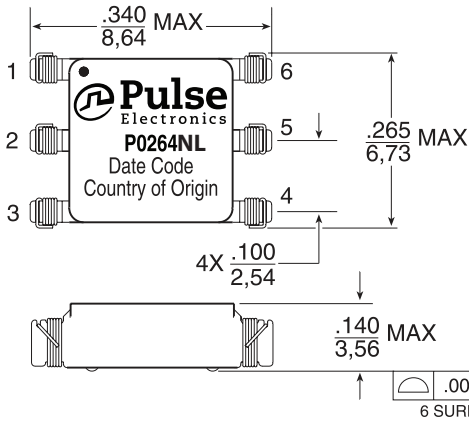

**SUGGESTED PAD LAYOUT**

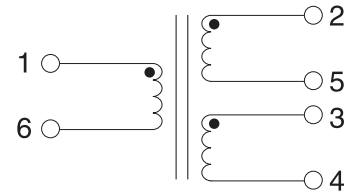

**Weight** .....0.28 grams  
**Tape & Reel** .....1500/reel  
**Tube** .....60/tube

**Dimension:**  $\frac{\text{Inches}}{\text{mm}}$   
 Unless otherwise specified, all tolerances are  $\pm \frac{.010}{0,25}$

### P0926NL

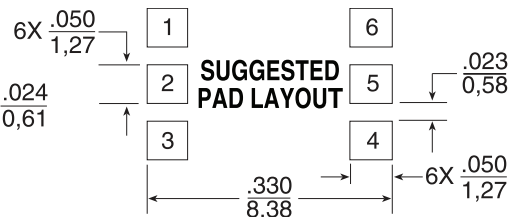
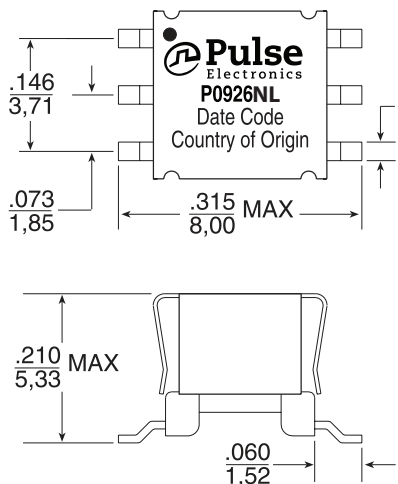

**SUGGESTED PAD LAYOUT**

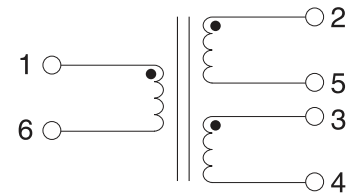

**Weight** .....0.48 grams  
**Tape & Reel** .....1000/reel  
**Tube** .....80/tube

**Dimension:**  $\frac{\text{Inches}}{\text{mm}}$   
 Unless otherwise specified, all tolerances are  $\pm \frac{.010}{0,25}$

# SMT Gate Drive Transformers

>1500VDC Basic and Functional Insulation

## Mechanicals (continued)

## Schematics

**P0544NL, PA0297, PA0510, PA0184NL**

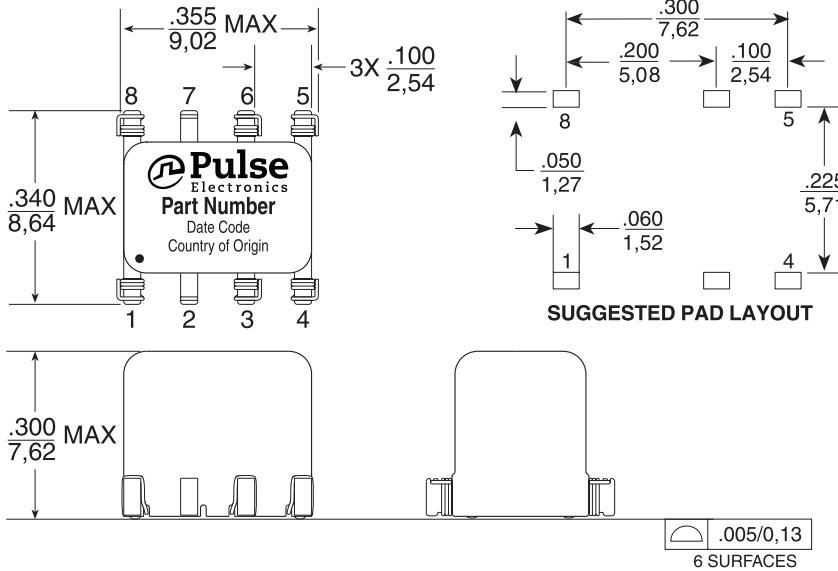

**P0544 / PA0297 / PA0510**

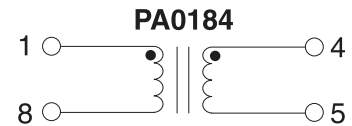
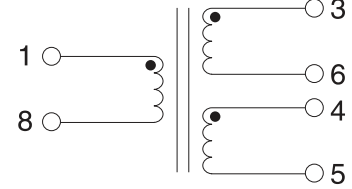

**Weight** .....0.60 grams  
**Tape & Reel** .....40/reel  
**Tube** .....50/tube

**Dimension:** Inches  
 mm

Unless otherwise specified, all tolerances are  $\pm \frac{.010}{0,25}$

\*for PA0184 the pads for pins 3 and 6 in the suggested pad layout should not be used in the layout

**PA0173, PA0185**

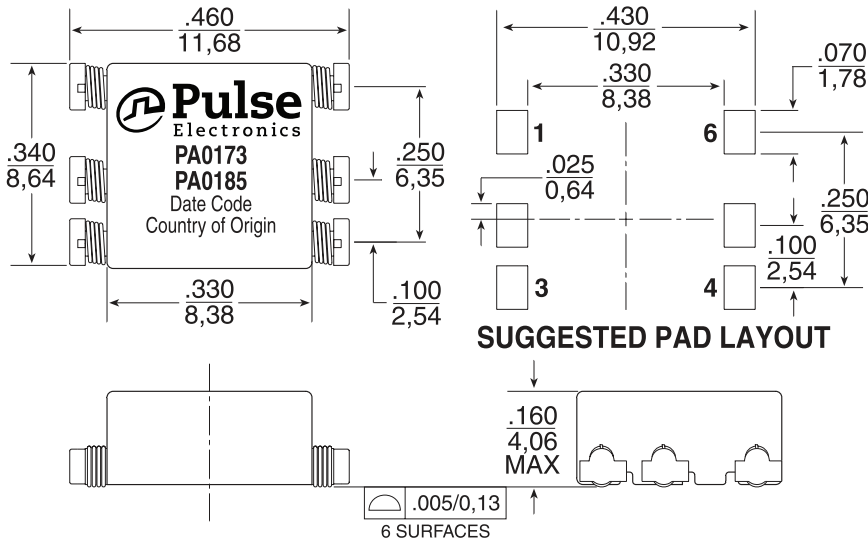

**PA0173**

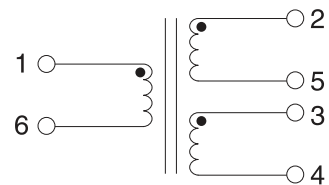

**PA0185**

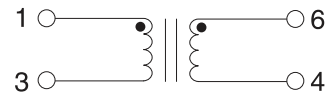

**Weight** .....0.48 grams  
**Tape & Reel** .....900/reel  
**Tube** .....60/tube

**Dimension:** Inches  
 mm

Unless otherwise specified, all tolerances are  $\pm \frac{.010}{0,25}$

# SMT Gate Drive Transformers

>1500VDC Basic and Functional Insulation

## Mechanicals (continued)

## Schematics

### PA3493NL

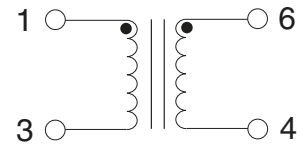
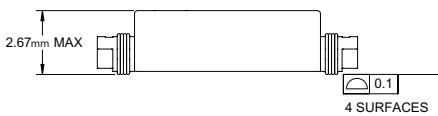
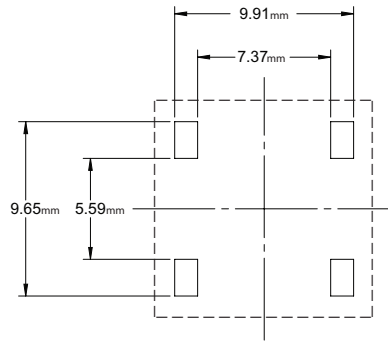
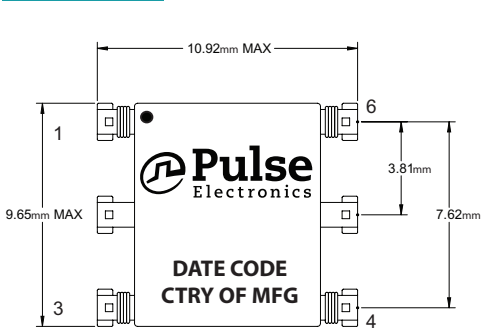

Weight .....0.31 grams  
 Tape & Reel .....1250/reel  
 Tube .....50/tube

Dimension: mm

Unless otherwise specified, all tolerances are  $\pm 0,25$

### PA2777NL

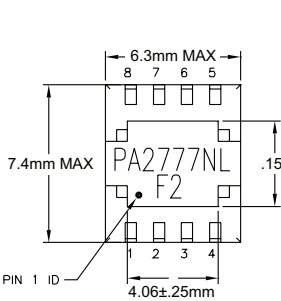

TOP VIEW

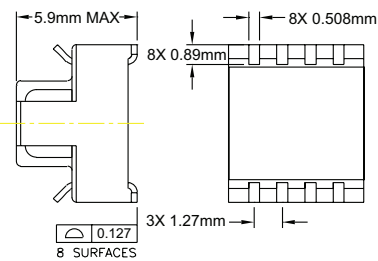

BOTTOM VIEW

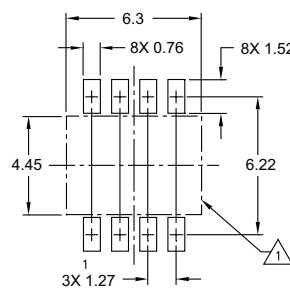

SUGGESTED LAND PATTERN

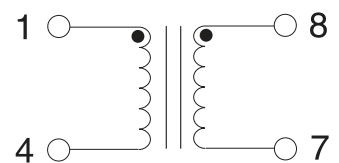

Weight .....0.32 grams  
 Tape & Reel .....850/reel  
 Tube .....120/tube

Dimension: mm

Unless otherwise specified, all tolerances are  $\pm 0,25$

# SMT Gate Drive Transformers

>1500VDC Basic and Functional Insulation

## Mechanicals (continued)

## Schematics

PA1323NL

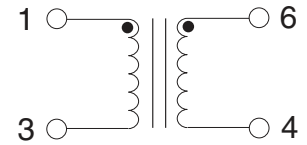
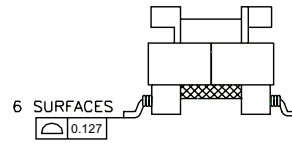
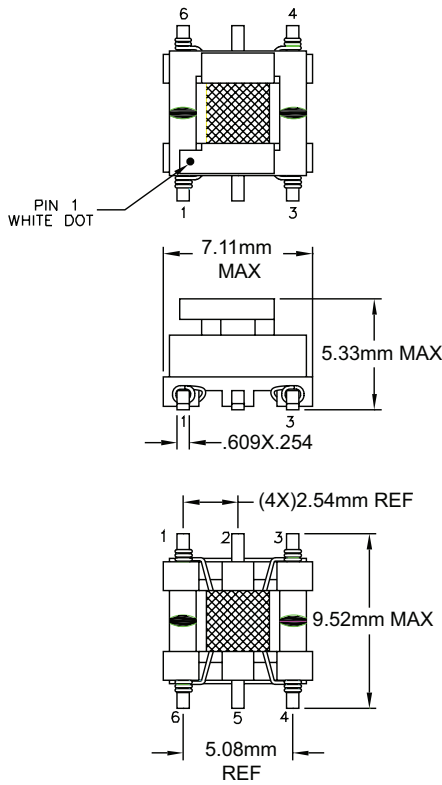

Weight .....0.4 grams  
 Tape & Reel .....700/reel  
 Tube .....225/tube

**Dimension:** mm

Unless otherwise specified, all tolerances are  $\pm 0,25$

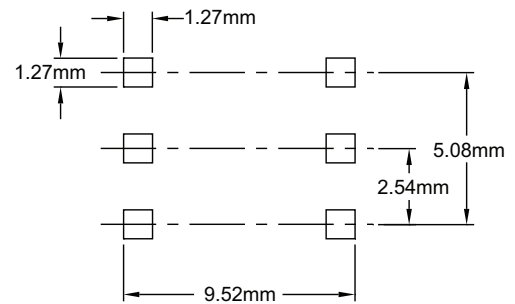

SUGGESTED PCB LAYOUT

## X-ON Electronics

Largest Supplier of Electrical and Electronic Components

*Click to view similar products for [Audio Transformers](#) / [Signal Transformers](#) category:*

*Click to view products by [Pulse manufacturer](#):*

Other Similar products are found below :

[749023020](#) [CU4S0506AT-2655-H1](#) [MET-58](#) [PE-64961](#) [H5008FNL](#) [H5020FNLT](#) [H5079NLT](#) [1879479-1](#) [1879564-1](#) [PA1277NLT](#)  
[PA1528ANL](#) [PA2007NLT](#) [FL1066](#) [T1137NLT](#) [T3012NL](#) [PE-65812FNL](#) [TTC-100](#) [TTC-143-H](#) [TTC-5032-1](#) [HX1234NLT](#) [HX5008FNLT](#)  
[100B-1001XNL](#) [PA1282NLT](#) [HX5084FNL](#) [T1108NLT](#) [2-1879391-5](#) [TTC-266-2](#) [3-1879385-4](#) [PA1032NL](#) [H2009FNLT](#) [PA0801NLT](#)  
[TTC-266](#) [X-1619](#) [SM51295PEL](#) [T5008NLT](#) [PE-68517T](#) [HX1294NLT](#) [HX5084FNLT](#) [H5015FNLT](#) [H6080NLT](#) [CX2024NL](#) [HX1294FNLT](#)  
[TX1473NLT](#) [PE-69011NLT](#) [CX2047LNLT](#) [CX2043LNLT](#) [DCT20EFD-U32S003](#) [H5120NLT](#) [H7137FNLT](#) [H1259NLT](#)