

## GaAs MMIC VOLTAGE - VARIABLE ATTENUATOR, 10 - 40 GHz

### Typical Applications

The HMC985ALP4KE is ideal for:

- Point-to-Point Radio
- VSAT Radio
- Test Instrumentation
- Microwave Sensors
- Military, ECM & Radar

### Features

- Wide Bandwidth: 10 - 40 GHz
- Excellent Linearity: +32 dB Input IP3
- Wide Attenuation Range: 35 dB
- No External Matching
- 24 Lead 4x4 mm SMT Package: 16 mm<sup>2</sup>

### Functional Diagram

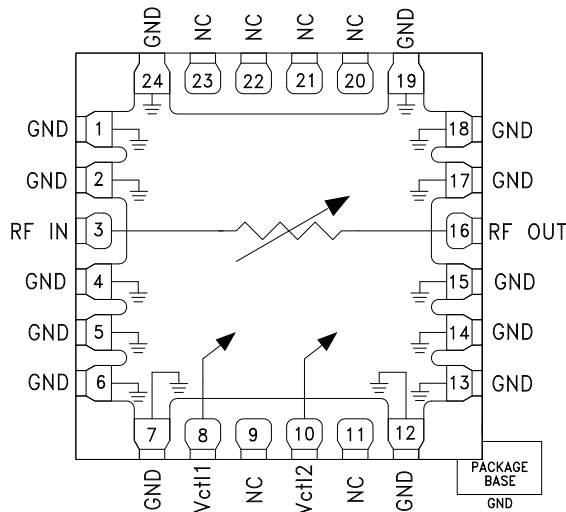

### General Description

The HMC985ALP4KE is an absorptive Voltage Variable Attenuator (VVA) which operates from 10 - 40 GHz and is ideal in designs where an analog DC control signal must be used to control RF signal levels over a 35 dB dynamic range. It features two shunt-type attenuators which are controlled by two analog voltages, Vctl1 and Vctl2. Optimum linearity performance of the attenuator is achieved by first varying Vctl1 of the first attenuation stage from -5V to 0V with Vctl2 fixed at -5V. The control voltage of the second attenuation stage, Vctl2, should then be varied from -5V to 0V with Vctl1 fixed at 0V.

If the Vctl1 and Vctl2 pins are connected together it is possible to achieve the full analog attenuation range with only a small degradation in input IP3 performance. Applications include AGC circuits and temperature compensation of multiple gain stages in microwave point-to-point and VSAT radios.

### Electrical Specifications, $T_A = +25^\circ\text{C}$ , Test Condition $V_{ctl1} = V_{ctl2}$

Parameter	Frequency	Min.	Typ.	Max.	Units
Insertion Loss [1]	10 - 20 GHz		3.1	3.9	dB
	20 - 30 GHz		2.1	3.5	dB
	30 - 40 GHz		2.9	4.0	dB
Attenuation Range	10 - 20 GHz	25	30		dB
	20 - 30 GHz	30	39		dB
	30 - 40 GHz	35	42		dB
Input Return Loss	10 - 40 GHz		13		dB
Output Return Loss	10 - 40 GHz		13		dB
Input Third Order Intercept (two-tone input Power = 10 dBm Each Tone) [2]			32		dBm

[1] Vctl1 = Vctl2 = -4V

[2] Vctl1 = Vctl2 = -3.4V worst case

**GaAs MMIC VOLTAGE - VARIABLE ATTENUATOR, 10 - 40 GHz**

**Attenuation vs. Frequency over Vctl1 = Variable, Vctl2 = -5V**

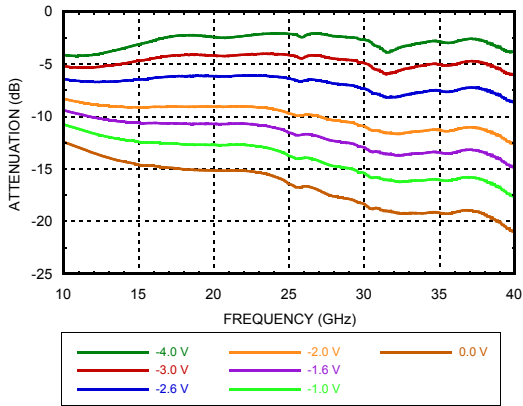

**Attenuation vs. Frequency over Vctl1 = 0V, Vctl2 = Variable**

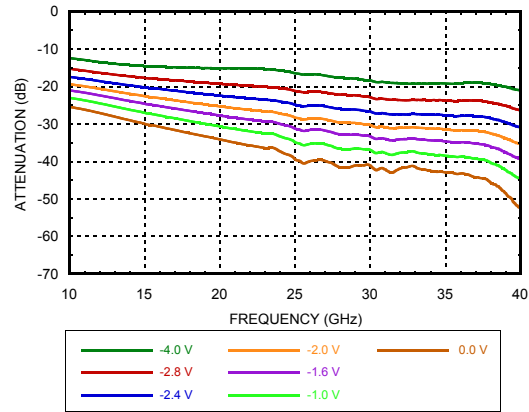

**Attenuation vs. Vctl1 Over Temperature @ 25 GHz, Vctl2 = -5V**

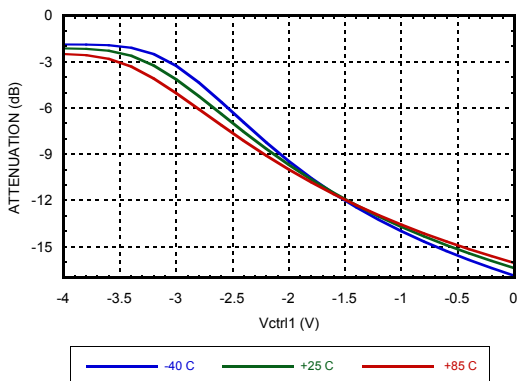

**Attenuation vs. Vctl2 Over Temperature @ 30 GHz, Vctl1 = 0V**

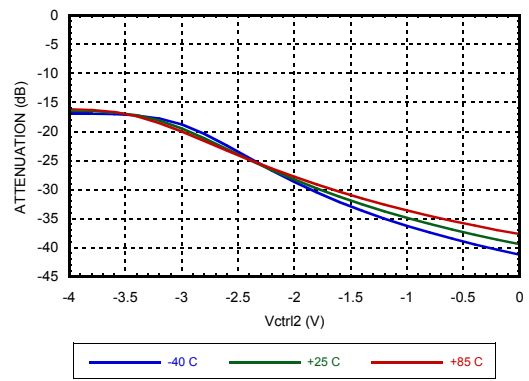

**Attenuation vs. Pin @ 20 GHz over Vctl1 Variable, Vctl2 = -3V**

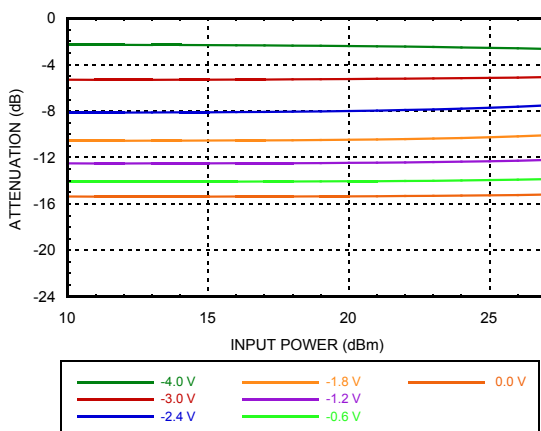

**Attenuation vs. Pin @ 20 GHz over Vctl2 Variable, Vctl1 = 0V**

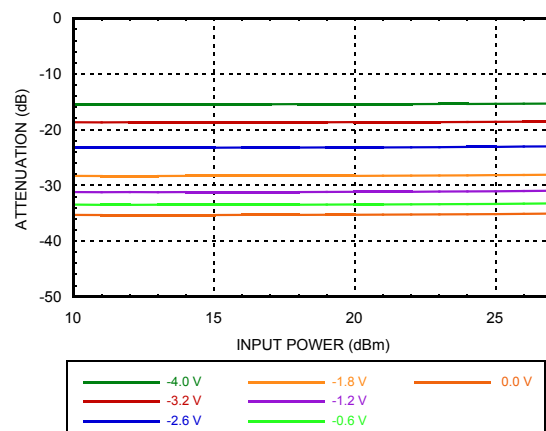

**GaAs MMIC VOLTAGE - VARIABLE ATTENUATOR, 10 - 40 GHz**

ATTENUATORS - ANALOG - SMT

**Input Return Loss**  
Vctl1 = Variable, Vctl2 = -5V

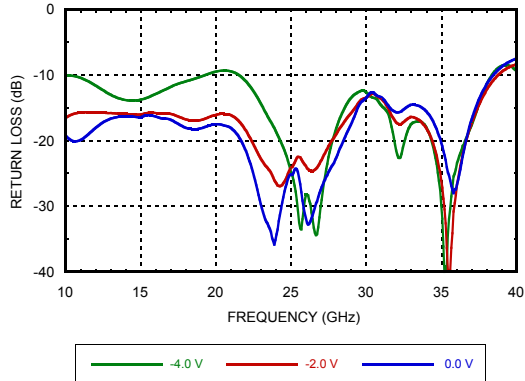

**Input Return Loss**  
Vctl1 = 0V, Vctl2 = Variable

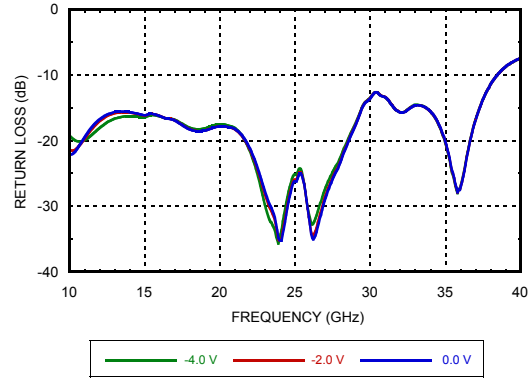

**Output Return Loss**  
Vctl1 = Variable, Vctl2 = -5V

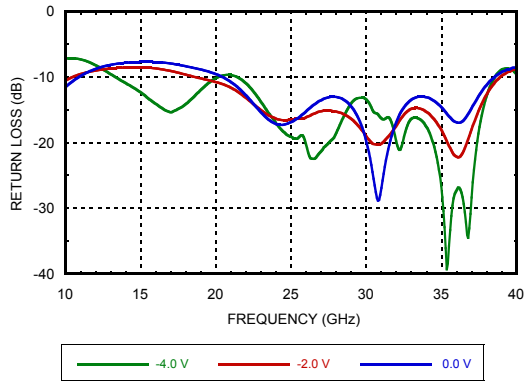

**Output Return Loss**  
Vctl1 = 0V, Vctl2 = Variable

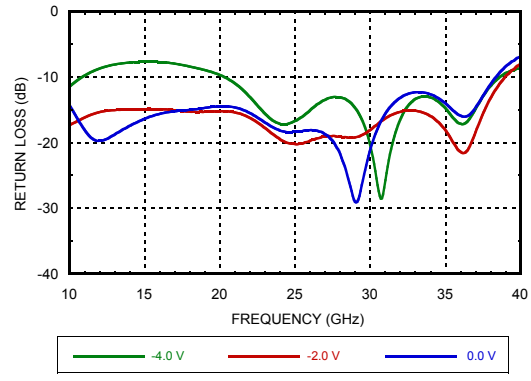

**Input IP3 vs. Input Power @ 20 GHz**  
Vctl1 = Variable, Vctl2 = -5V

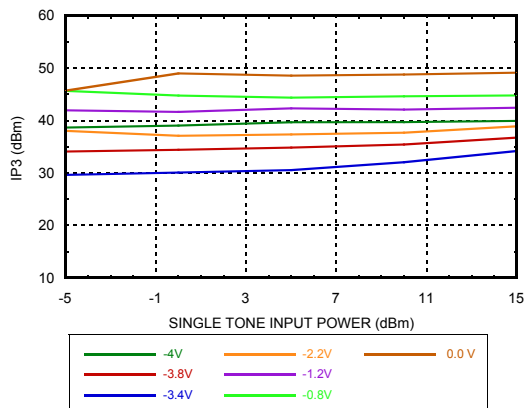

**Input IP3 vs. Input Power Over Frequency**  
Vctl1 = -3.2V, Vctl2 = -5V [1]

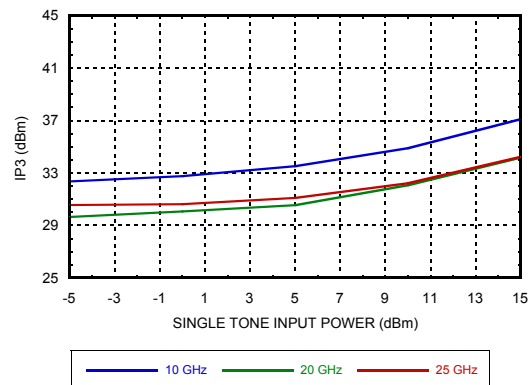

[1] Worst Case IP3

**GaAs MMIC VOLTAGE - VARIABLE  
ATTENUATOR, 10 - 40 GHz**

**Input IP3 vs. Input Power Over Temperature  
@ 20 GHz, Vctl1 = -3.4V, Vctl2 = -5V [1]**

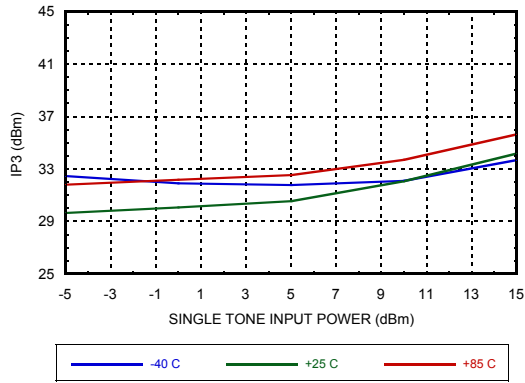

**Input IP3 vs. Input Power @ 20 GHz  
Vctl2 = Variable, Vctl1 = 0V**

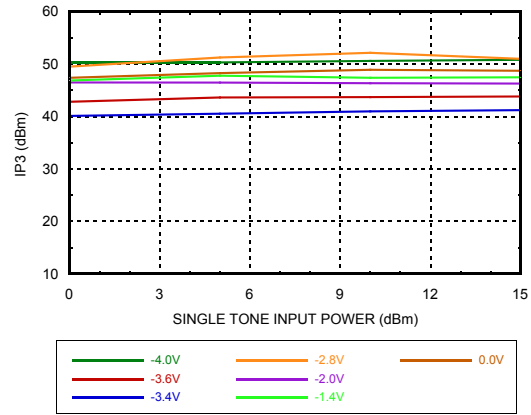

**Input IP3 vs. Input Power Over Frequency  
Vctl2 = -3.4V, Vctl1 = 0V [1]**

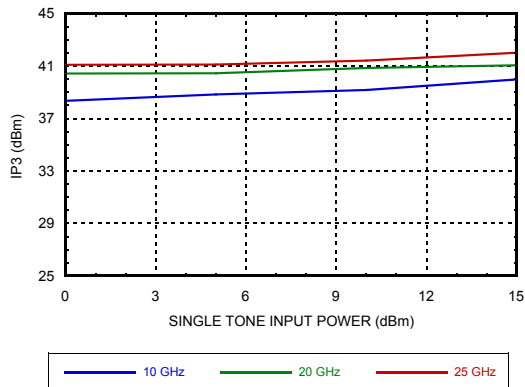

**Input IP3 vs Input Power over Tempera-  
ture @ 20 GHz, Vctl2 = -3.4V, Vctl1 = 0V [1]**

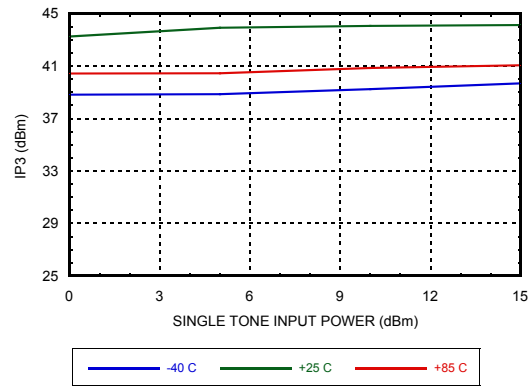

[1] Worst Case IP3

**GaAs MMIC VOLTAGE - VARIABLE ATTENUATOR, 10 - 40 GHz**

**Attenuation vs Frequency Over Vctrl**  
Vctrl1 = Vctrl2

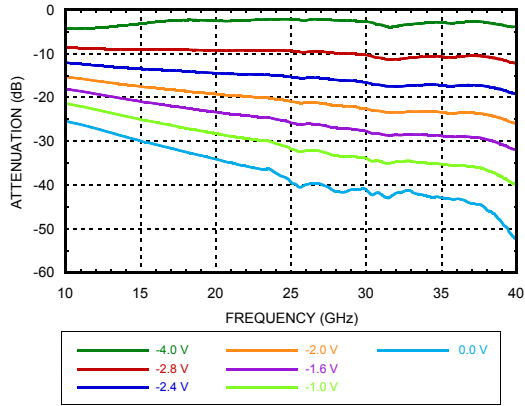

**Attenuation vs. Vctrl Over Temperature**  
@ 20 GHz, Vctrl1 = Vctrl2

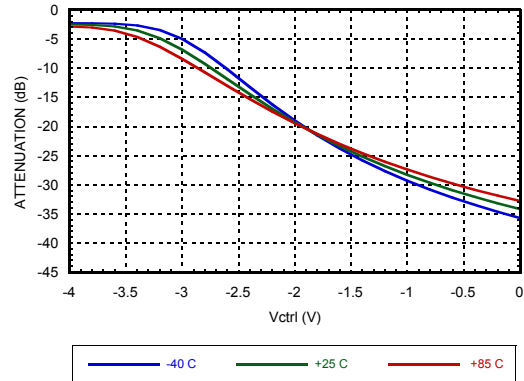

**Attenuation vs. Pin @ 20 GHz Over Vctrl**  
Vctrl1 = Vctrl2

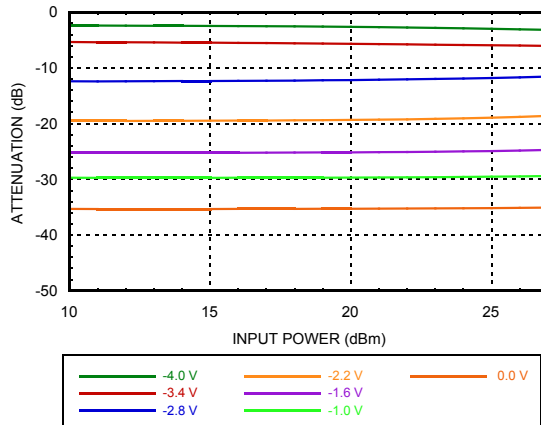

**Input Return Loss, Vctrl1 = Vctrl2**

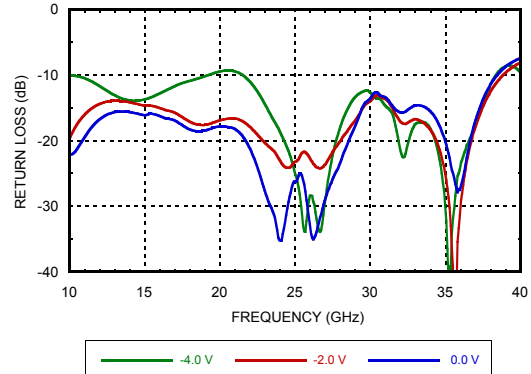

**Output Return Loss, Vctrl1 = Vctrl2**

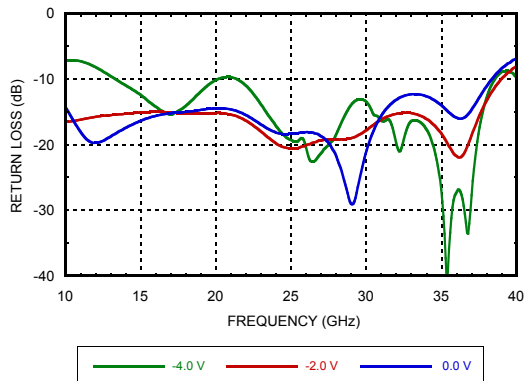

**Input IP3 vs. Input Power Over Vctrl @ 20 GHz, Vctrl1 = Vctrl2**

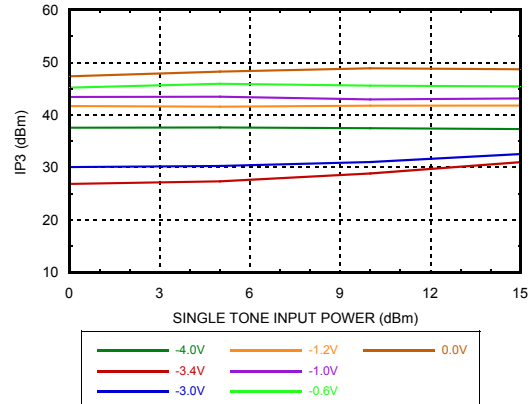

**GaAs MMIC VOLTAGE - VARIABLE  
ATTENUATOR, 10 - 40 GHz**

**Input IP3 vs. Input Power Over Frequency**  
Vctl1 = Vctl2

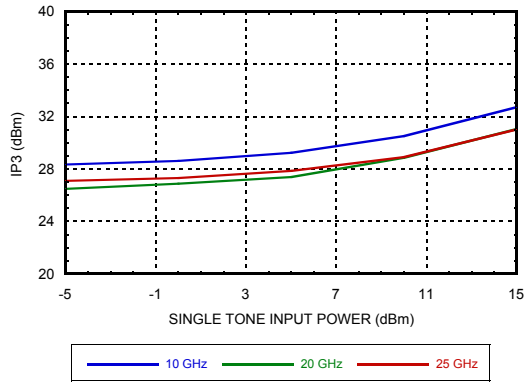

**Input IP3 vs. Input Power Over Temperature @ 20 GHz**  
Vctl1 = Vctl2

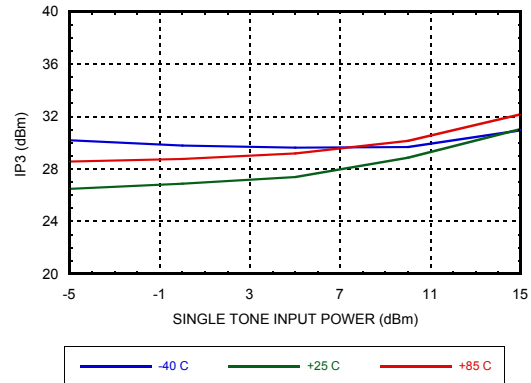



## GaAs MMIC VOLTAGE - VARIABLE ATTENUATOR, 10 - 40 GHz

### Pin Descriptions

Pin Number	Function	Description	Pin Schematic
1, 2, 4-7, 12-15, 17-19, 24	GND	These pins and package bottom must be connected to RF/DC ground externally.	
3	RFIN	This pad is DC coupled and matched to 50 Ohms.	
8	Vctl1	Control Voltage 1.	
9, 11, 20-23	NC	These pins are not connected internally, however all data shown herein was measured with these pins connected to RF/DC ground externally.	
10	Vctl2	Control Voltage 2.	
16	RFOUT	This pad is DC coupled and matched to 50 Ohms.	

### Assembly Diagram

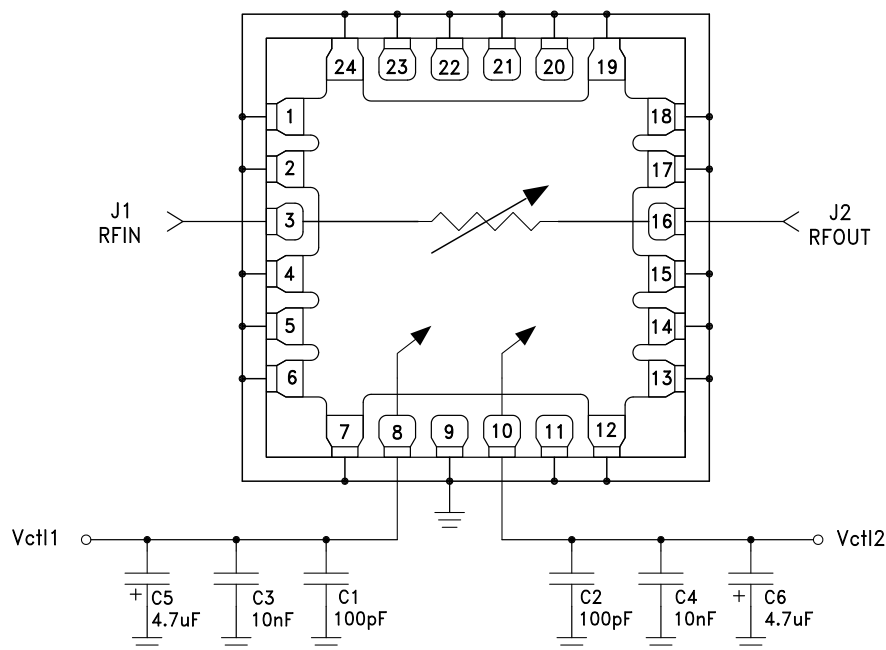



**GaAs MMIC VOLTAGE - VARIABLE  
ATTENUATOR, 10 - 40 GHz**

**Evaluation PCB**

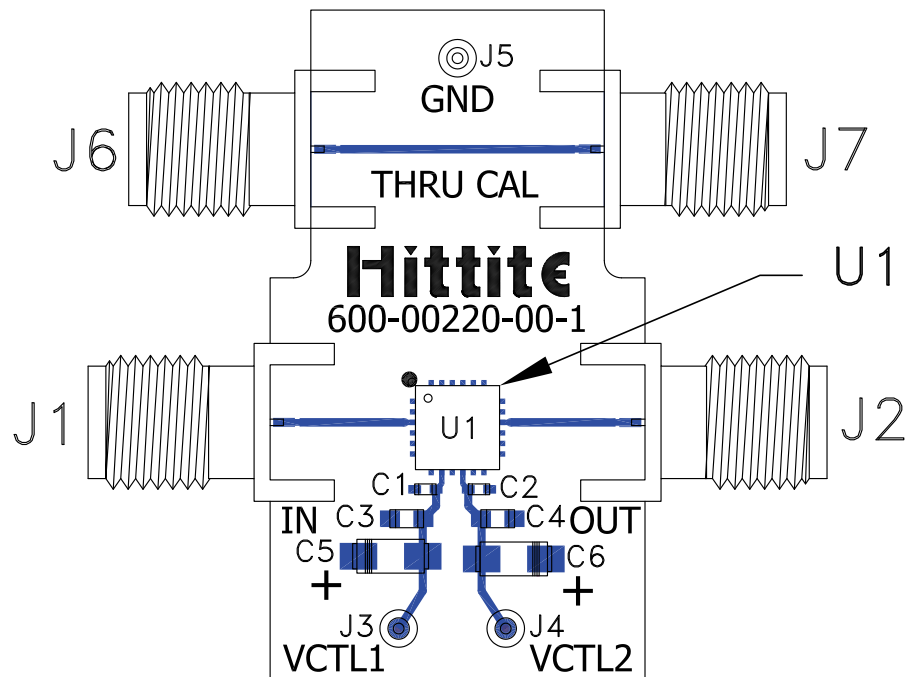

**List of Materials for Evaluation PCB EV1HMC985ALP4K [1]**

Item	Description
J1-J2, J6-J7	K Connectors.
J3-J5	DC Pins.
C1-C2	100pF Capacitors, 0402 Pkg.
C3-C4	0.01 $\mu$ F Capacitor, 0603 Pkg.
C5-C6	4.7 $\mu$ F Case A, Tantalum.
U1	HMC985ALP4KE VVA.
PCB	600-00220-00 Evaluation PCB.

[1] Reference this number when ordering complete evaluation PCB

The circuit board used in the final application should use RF circuit design techniques. Signal lines should have 50 Ohm impedance while the package ground leads and exposed paddle should be connected directly to the ground plane similar to that shown. A sufficient number of via holes should be used to connect the top and bottom ground planes. The evaluation circuit board shown is available from Analog Devices upon request.

**GaAs MMIC VOLTAGE - VARIABLE  
ATTENUATOR, 10 - 40 GHz****Notes:**

## X-ON Electronics

Largest Supplier of Electrical and Electronic Components

*Click to view similar products for [Attenuators](#) category:*

*Click to view products by [Analog Devices](#) manufacturer:*

Other Similar products are found below :

[MAATCC0010](#) [HMC305SLP4ETR](#) [MAAD-009195-000100](#) [MAADSS0012TR](#) [TGL4201-02](#) [ATN3590-15](#) [20-50TPC](#) [D10AA5Z4](#)  
[HMC346LP3TR](#) [18AH-01](#) [18AH-03](#) [18AH-08](#) [ATN3590-09](#) [20-50RP](#) [MASW-008322-000000](#) [MAAVSS0004](#) [PCAF-10](#) [EXB-](#)  
[24AT9AR5X](#) [ATN3580-06](#) [HMC539ALP3ETR](#) [HMC291SETR](#) [HMC941A-SX](#) [HMC1119LP4METR](#) [F1977NBGI8](#) [HMC802ALP3ETR](#)  
[HMC-VVD106-SX](#) [WA04P006XCTL](#) [SKY12408-321LF](#) [TGL2226](#) [WA04P005XBTL](#) [EXB-14AT3AR3X](#) [HMC-VVD104-SX](#) [SKY12236-](#)  
[11](#) [MAATSS0018TR-3000](#) [HMC656-SX](#) [WA04P001XBTL](#) [MAAV-007941-TR3000](#) [WA04P004XBTL](#) [HMC425ALP3ETR](#)  
[WA04P002XBTL](#) [MAT10010](#) [MAT10040](#) [EXB-24N182JX](#) [EXB-24N181JX](#) [EXB-24N183JX](#) [20-50TPR](#) [HMC941A](#) [PAT0816-C-0DB-T5](#)  
[PAT0816-C-8DB-T5](#) [PAT0816-C-3DB-T5](#)