

# Keysight Technologies

HMMC-5021, HMMC-5022,  
HMMC-5026, and QMMC-5002

GaAs MMIC Traveling Wave Amplifier

Data Sheet

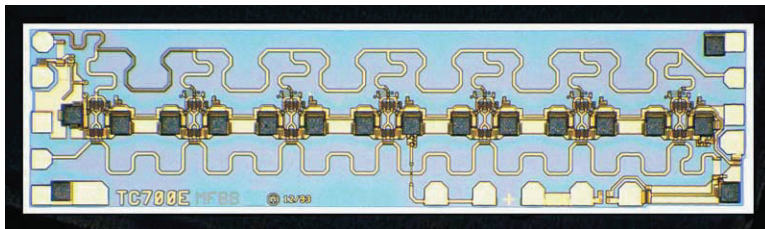

## Features

- Wide-frequency range:  
2 to 26.5 GHz
- High gain: 9.5 dB
- Gain flatness:  $\pm 0.75$  dB
- Return loss:  
Input: -14 dB, Output: -13 dB
- Low-frequency operation capability:  
< 2 GHz
- Gain control: 35 dB dynamic range
- Moderate power:  
20 GHz:  
 $P_{-1\text{ dB}}$  : 18 dBm  
 $P_{\text{sat}}$  : 20 dBm  
26.5 GHz:  
 $P_{-1\text{ dB}}$  : 15 dBm  
 $P_{\text{sat}}$  : 17 dBm

## Description

The HMMC-5021/22/26/QMMC-5002 is a broadband GaAs MMIC traveling wave amplifier designed for high gain and moderate output power over the full 2 to 26.5 GHz frequency range. Seven MES-FET cascode stages provide a flat gain response, making the HMMC-5021/22/26/QMMC-5002 an ideal wideband gain block. Optical lithography is used to produce gate lengths of  $\approx 0.4 \mu\text{m}$ . The HMMC-5021/22/26/QMMC-5002 incorporates advanced MBE technology, Ti-Pt-Au gate metallization, silicon nitride passivation, and polyimide for scratch protection.

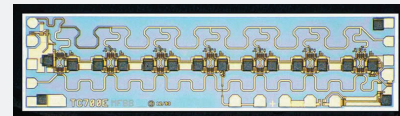

Chip size:  
 $2980 \times 770 \mu\text{m}$  (117.3  $\times$  30.3 mils)  
 Chip size tolerance:  
 $\pm 10 \mu\text{m}$  ( $\pm 0.4$  mils)  
 Chip thickness:  
 $127 \pm 15 \mu\text{m}$  ( $5 \pm 0.6$  mils)  
 Pad dimensions:  
 $75 \times 75 \mu\text{m}$  (2.95  $\times$  2.95 mils),  
 or larger

## Absolute Maximum Ratings<sup>1</sup>

Symbol	Parameters/conditions	Minimum	Maximum	Units
$V_{DD}$	Positive drain voltage		8.0	Volts
$I_{DD}$	Total drain current		250	mA
$V_{G1}$	First gate voltage	-5	0	Volts
$I_{G1}$	First gate current	-9	+5	mA
$V_{G2}$ <sup>2</sup>	Second gate voltage	-2.5	+3.5	Volts
$I_{G2}$	Second gate current	-7		mA
$P_{DC}$	DC power dissipation		2.0	Watts
$P_{in}$	CW input power		23	dB
$T_{ch}$	Operating channel temp.		+150	°C
$T_{case}$	Operating case temp.	-55		°C
$T_{stg}$	Storage temperature	-65	+165	°C
$T_{max}$	Maximum assembly temp. (for 60 seconds maximum)		300	°C

- Operation in excess of any one of these conditions may result in permanent damage to this device.  
 $T_A = 25 \text{ }^\circ\text{C}$  except for  $T_{ch}$ ,  $T_{stg}$ , and  $T_{max}$ .
- Minimum voltage on  $V_{G2}$  must not violate the following:  $V_{G2}(\text{min}) > V_{DD} - 9$  volts.

1GG7-8000, 1GG7-8006, 1GG7-8007

## DC Specifications/Physical Properties<sup>1</sup> (Applies to All Part Numbers)

Symbol	Parameters/conditions	Min.	Typ.	Max	Units
$I_{DSS}$	Saturated drain current ( $V_{DD} = 7.0$ V, $V_{G1} = 0.0$ V, $V_{G2} =$ open circuit)	115	180	250	mA
$V_p$	First gate pinch-off voltage ( $V_{DD} = 7.0$ V, $I_{DD} = 16$ mA, $V_{G2} =$ open circuit)	-3.5	-1.5	-0.5	volts
$V_{G2}$	Second gate self-bias voltage ( $V_{DD} = 7.0$ V, $V_{G1} = 0.0$ V)		2.1		volts
$I_{DSOFF}(V_{G1})$	First gate pinch-off current ( $V_{DD} = 7.0$ V, $V_{G1} = -3.5$ V, $V_{G2} =$ open circuit)		4		mA
$I_{DSOFF}(V_{G2})$	Second gate pinch-off current ( $V_{DD} = 5.0$ V, $V_{G1} = 0.0$ V, $V_{G2} = -3.5$ V)		8		mA
$\theta_{ch-bs}$	Thermal resistance ( $T_{backside} = 25$ °C)		36		°C/W

1. Measured in wafer form with  $T_{chuck} = 25$  °C. (except  $\theta_{ch-bs}$ ).

## RF Specifications

( $V_{DD} = 7.0$  V,  $I_{DD}(Q) = 150$  mA,  $Z_{in} = Z_o = 50$   $\Omega$ )<sup>1</sup>

Symbol	Parameters/conditions	5021		5022		5026			QMMC-5002		Units		
		2.0 to 22.0 GHz		2.0 to 22.0 GHz		2.0 to 26.5 GHz			2.0 to 22.0 GHz				
		Typ	Min	Max	Min	Max	Typ.	Min	Max	Min	Max		
BW	Guaranteed bandwidth <sup>2</sup>		2	22	2	22		2	24	26.5	2	22	GHz
$S_{21}$	Small signal gain	10			8	12	9.5	7	12	10 <sup>3</sup>	14 <sup>3</sup>		dB
$\Delta S_{21}$	Small signal gain flatness	$\pm 0.5$				$\pm 1$	$\pm 0.75$		$\pm 1.5$		$\pm 0.5^3$		dB
$RL_{in(min)}$	Minimum input return loss	16			15		14	12		15			dB
$RL_{out(min)}$	Minimum output return loss	13			13		13	10		13			dB
Isolation	Minimum reverse isolation	32			23		30	23		23			dB
$P_{-1dB}$	Output power at 1 dB gain compression	18			15		15	12		15			dBm
$P_{sat}$	Saturated output power	20			17		17	14	18	17			dBm
$H_{2(max)}$	Max. second harm. ( $2 < f_o < 20$ ), [ $P_o(f_o) = 17$ dBm or $P_{-1dB}$ , whichever is less]	-25				-20	-25		-20		-20		dBc
$H_{3(max)}$	Max. third harm. ( $2 < f_o < 20$ ), [ $P_o(f_o) = 17$ dBm or $P_{-1dB}$ , whichever is less]	-34				-20	-34		-20		-20		dBc
NF	Noise figure	8					10						dB

- Small-signal data measured in wafer form with  $T_{chuck} = 25$  °C. Large-signal data measured on individual devices mounted in an Keysight 83040 Series Modular Microcircuit Package @  $T_A = 25$  °C.
- Performance may be extended to lower frequencies through the use of appropriate off-chip circuitry. Upper -3 dB corner frequency ~ 29.5 GHz.
- These specifications are applicable to 2.0 to 18 GHz only.

## Applications

The HMMC-5021/22/26/QMMC-5002 Series of traveling wave amplifiers are designed for use as general purpose wideband gain blocks in communication systems and microwave instrumentation. They are ideally suited for broadband applications requiring a flat gain response and excellent port matches over a 2 to 26.5 GHz frequency range. Dynamic gain control and low-frequency extension capabilities are designed into these devices.

It is characteristic of traveling wave amplifiers that  $S_{22}$  tends to 0 dB and greater out of band. This is the design trade-off for the broadband performance of TWAs. As a consequence, TWAs are not necessarily unconditionally stable out of band. This means that if a TWA is followed by a reflective low-pass filter, oscillations can occur. This phenomenon is exacerbated by low temperature where the gain is higher. More data will follow on individual devices.

## Biasing and Operation

These amplifiers are biased with a single positive drain supply ( $V_{DD}$ ) and a single negative gate supply ( $V_{G1}$ ). The recommended bias conditions for the HMMC-5021/22/26/QMMC-5002 are  $V_{DD} = 7.0$  V,  $I_{DD} = 150$  mA for best overall performance. To achieve this drain current level,  $V_{G1}$  is typically biased between  $-0.2$  V and  $-0.5$  V. No other bias supplies or connections to the device are required for 2 to 26.5 GHz operation. See Figure 3 for assembly information.

The auxiliary gate and drain contacts are used only for low-frequency performance extension below  $\approx 1.0$  GHz. When used, these contacts must be AC coupled only. (Do not attempt to apply bias to these pads.)

The second gate ( $V_{G2}$ ) can be used to obtain 35 dB (typical) dynamic gain control.

For normal operation, no external bias is required on this contact and its self-bias voltage is  $\approx +2.1$  V. Applying an external bias between its open-circuit voltage and  $-2.5$  volts will adjust the gain while maintaining a good input/output port match.

## Assembly Techniques

Solder die-attach using a flux-less AuSu solder preform is the recommended assembly method. Gold thermosonic wedge bonding with 0.7 mil diameter Au wire is recommended for all bonds. Tool force should be  $22 \pm 1$  gram, stage temperature should be  $150 \pm 2$  °C, and ultrasonic power and duration should be  $64 \pm 1$  dB and  $76 \pm 8$  msec, respectively. The bonding pad and chip backside metallization is gold.

GaAs MMICs are ESD sensitive. ESD preventive measures must be employed in all aspects of storage, handling, and assembly.

MMIC ESD precautions, handling considerations, die attach and bonding methods are critical factors in successful GaAs MMIC performance and reliability.

Keysight application note, *GaAs MMIC ESD, Die Attach and Bonding Guidelines* (5991-3484EN) provides basic information on these subjects.

## Additional References

*2–26.5 GHz Variable Gain Amplifier Using TC700 and TC701 GaAs MMIC Components*, Technical Overview (5991-3543EN)

*TC700/702 Traveling Wave Amplifier Environmental Data*, Technical Overview (5991-3553EN)

*TC700 S-Parameters Performance as a Function of Bonding Configuration*, Technical Overview (5991-3552EN)

*GaAs MMIC TWA*, Users Guide (5991-3545EN)

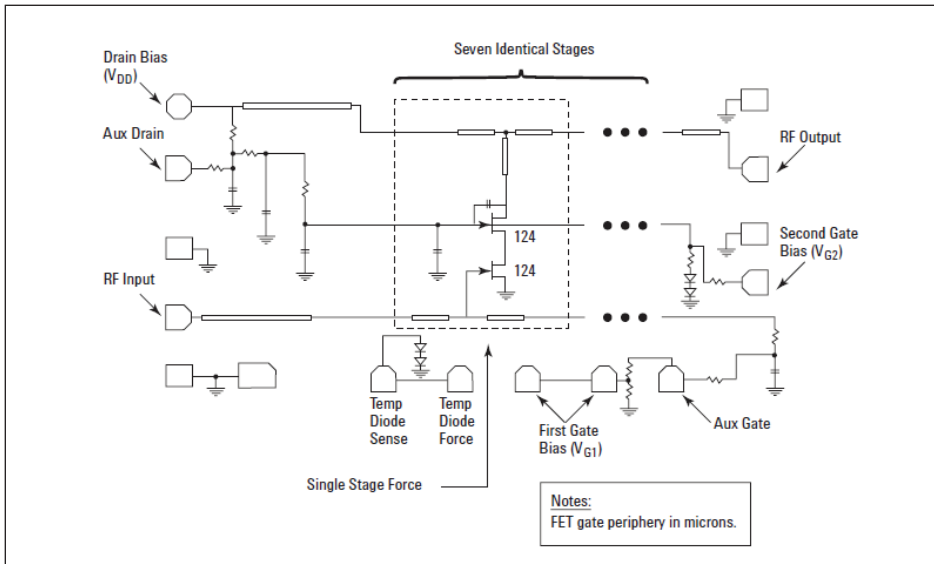

Figure 1. Schematic

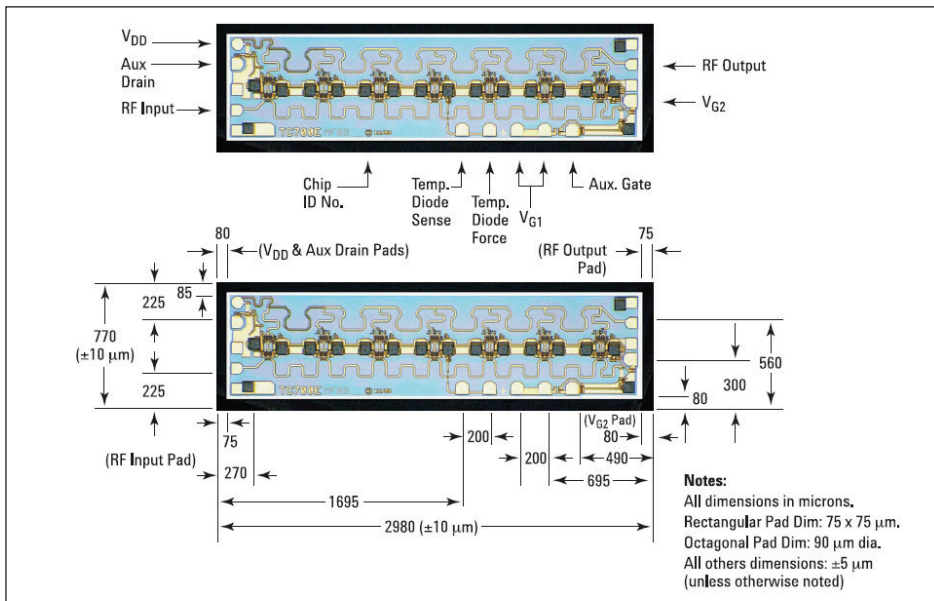

Figure 2. Bonding pad locations

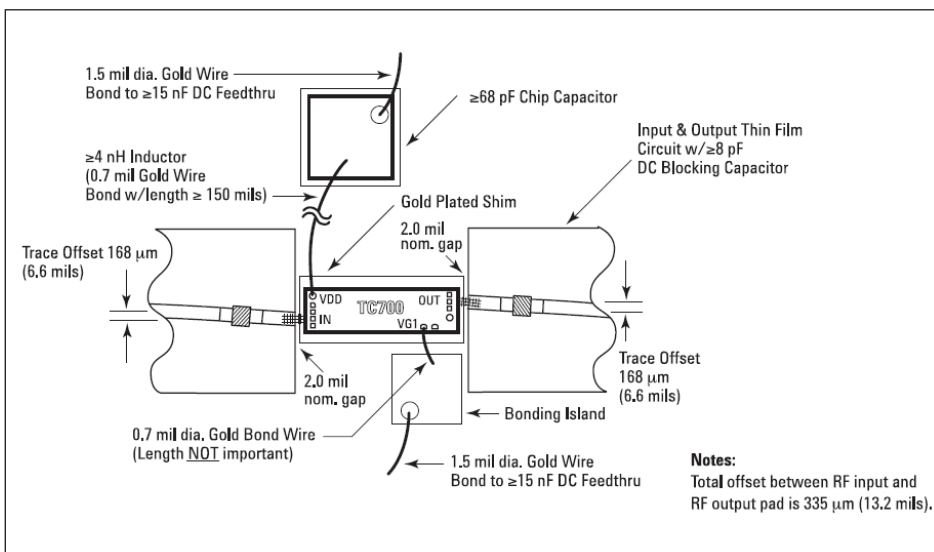

Figure 3. Assembly diagram (For 2.0 - 26.5 GHz operation)

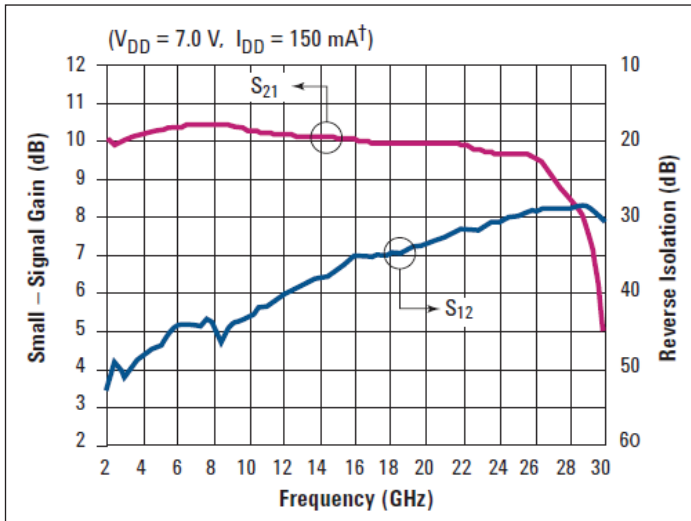

Figure 4. Typical gain and reverse isolation vs. frequency

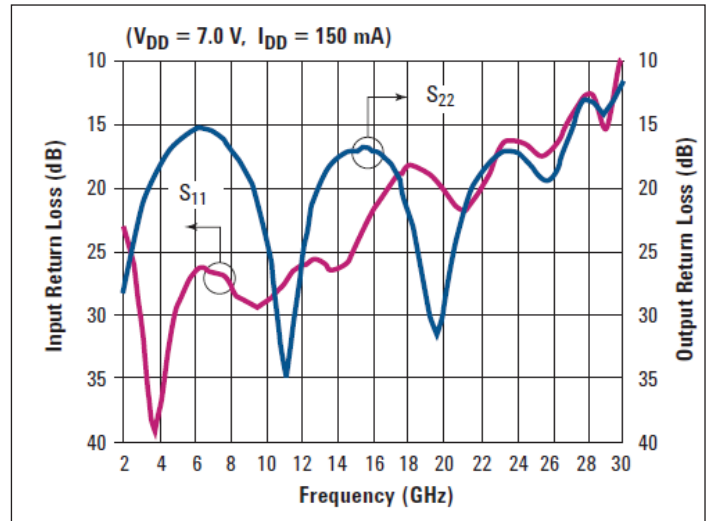

Figure 5. Typical input and out return loss vs. frequency

### Typical S-Parameters<sup>1</sup>

( $T_{\text{chuck}} = 25^\circ \text{C}$ ,  $V_{\text{DD}} = 7.0 \text{ V}$ ,  $I_{\text{DD}} = 150 \text{ mA}$ ,  $Z_{\text{in}} = Z_{\text{out}} = 50 \Omega$ )

Freq. (GHz)	$S_{11}$			$S_{12}$			$S_{21}$			$S_{22}$		
	dB	Mag	Ang	dB	Mag	Ang	dB	Mag	Ang	dB	Mag	Ang
2.0	-22.6	0.074	-174.1	-53.1	0.0022	167.3	-10.1	3.183	123.6	-28.9	0.036	77.3
3.0	-30.6	0.030	130.4	-51.0	0.0028	120.1	-10.0	3.173	102.1	-21.6	0.083	64.1
4.0	-37.8	0.013	-19.8	-48.0	0.0040	95.0	-10.2	3.225	78.2	-18.2	0.124	45.4
5.0	-29.4	0.034	-79.9	-46.8	0.0046	67.1	-10.3	3.275	53.5	-16.3	0.153	23.4
6.0	-26.6	0.047	-113.8	-44.4	0.0060	36.0	-10.4	3.303	28.1	-15.4	0.170	2.5
7.0	-26.6	0.047	-137.0	-44.1	0.0062	1.0	-10.3	3.330	2.3	-15.7	0.165	-19.5
8.0	-27.7	0.041	-152.6	-43.4	0.0067	-27.5	-10.5	3.331	-23.8	-17.0	0.141	-40.7
9.0	-29.0	0.035	-149.8	-44.3	0.0061	-31.8	-10.4	3.312	-50.2	-19.2	0.110	-59.7
10.0	-29.0	0.036	-140.8	-43.0	0.0071	-53.6	-10.3	3.282	-76.4	-24.3	0.061	-76.8
11.0	-27.3	0.043	-138.1	-41.6	0.0083	-74.8	-10.2	3.253	-102.5	-35.1	0.018	-32.6
12.0	-26.2	0.049	-141.9	-40.0	0.0100	-96.9	-10.2	3.227	-128.8	-24.6	0.059	21.0
13.0	-25.8	0.052	-148.5	-38.9	0.0113	-120.9	-10.2	3.218	-155.4	-19.7	0.103	2.8
14.0	-26.4	0.048	-143.0	-38.1	0.0125	-145.6	-10.1	3.204	177.8	-17.6	0.132	-21.2
15.0	-24.6	0.059	-131.7	-36.6	0.0148	-169.9	-10.1	3.197	150.4	-17.0	0.141	-44.8
16.0	-21.6	0.083	-133.7	-35.3	0.0172	160.9	-10.0	3.177	122.5	-17.1	0.140	-67.4
17.0	-19.4	0.107	-143.5	-35.0	0.0177	130.6	-10.0	3.149	94.4	-18.5	0.119	-91.8
18.0	-18.3	0.121	-158.7	-34.7	0.0184	105.0	-9.9	3.138	65.9	-21.8	0.081	-116.0
19.0	-18.7	0.116	-172.6	-33.9	0.0201	80.2	-9.9	3.140	36.8	-28.9	0.036	-121.7
20.0	-20.3	0.097	-179.5	-33.3	0.0217	50.7	-10.0	3.151	6.6	-28.5	0.038	-57.0
21.0	-21.8	0.082	-168.3	-32.7	0.0233	22.5	-10.0	3.150	-24.9	-21.7	0.082	-59.1
22.0	-19.9	0.101	-155.3	-31.7	0.0259	-8.4	-9.9	3.126	-57.5	-18.6	0.117	-81.5
23.0	-17.3	0.137	-158.8	-31.4	0.0268	-39.5	-9.8	3.076	-91.0	-17.3	0.137	-103.3
24.0	-16.3	0.153	-169.9	-30.7	0.0291	-71.5	-9.7	3.045	-125.5	-17.3	0.137	-123.8
25.0	-17.1	0.139	-175.4	-30.0	0.0317	-106.2	-9.7	3.045	-162.2	-18.5	0.118	-135.3
26.0	-17.0	0.141	-165.0	-29.2	0.0345	-145.5	-9.6	3.027	157.2	-19.4	0.107	-122.5
26.5	-15.7	0.163	-161.1	-29.0	0.0356	-166.7	-9.5	2.970	135.4	-17.6	0.132	-114.2
27.0	-14.3	0.192	-162.7	-28.9	0.0357	171.7	-9.2	2.876	112.9	-15.3	0.173	-116.0
28.0	-13.2	0.220	-175.7	-28.8	0.0362	126.3	-8.5	2.648	65.8	-12.6	0.233	-138.1
29.0	-14.1	0.197	-176.9	-28.6	0.0371	73.0	-7.7	2.433	10.3	-15.4	0.170	-144.7
30.0	-14.1	0.266	-171.6	-30.8	0.0287	4.8	-4.6	1.689	-61.1	-8.7	0.369	-123.6

1. Data obtained from on-wafer measurements.

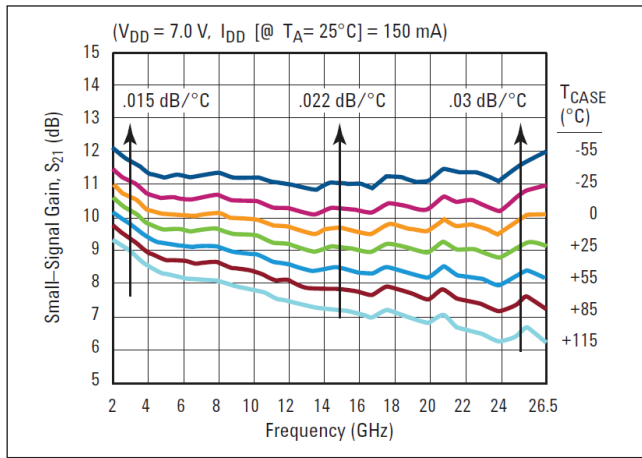

Figure 6. Typical small-signal gain vs. temperature

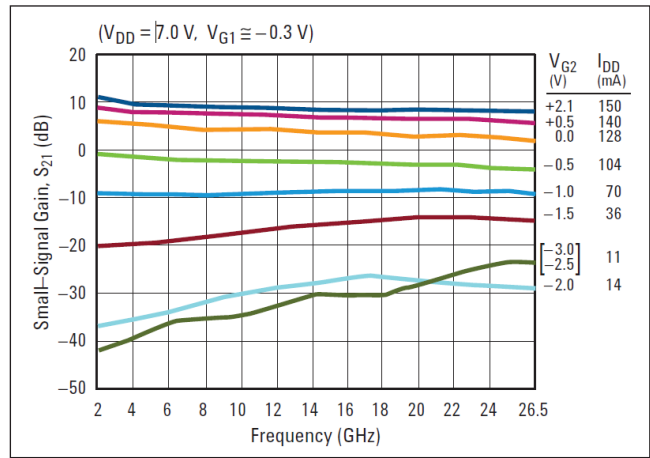

Figure 7. Typical gain vs. second gate control voltage

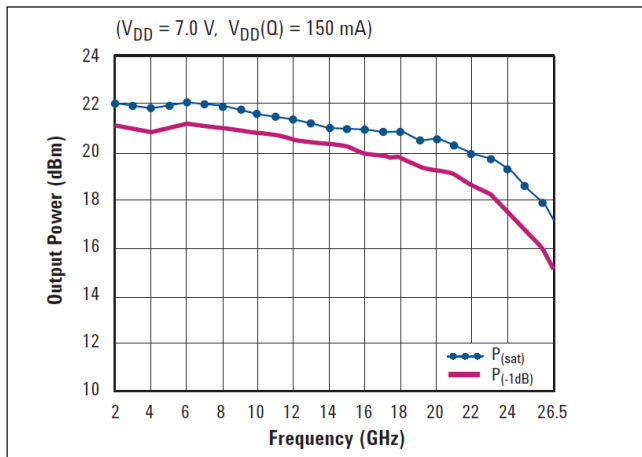

Figure 8. Typical 1 dB gain compression and saturated output power

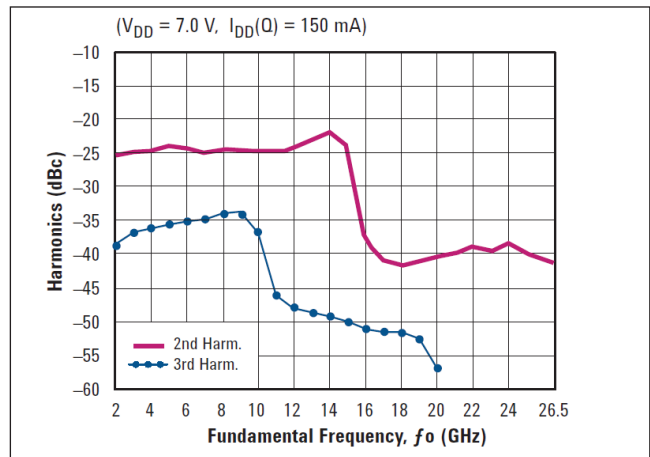

Figure 9. Typical second and third harmonics vs. fundamental frequency at P<sub>out</sub> = +17 dBm

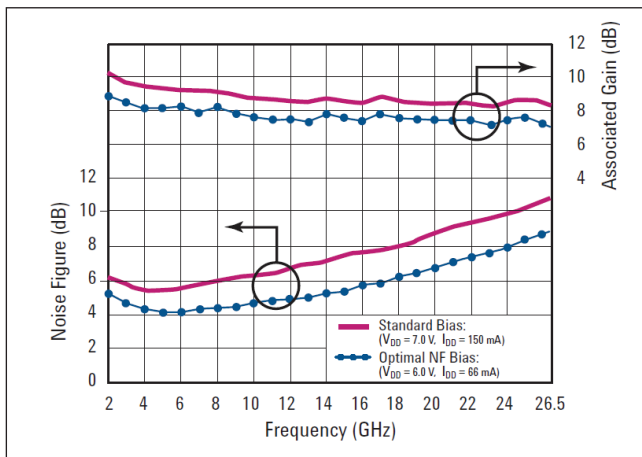

Figure 10. Typical noise figure performance

## Notes

All data measured on individual devices mounted in an Keysight 83040 Series Modular Microcircuit Package @ T<sub>A</sub> = 25 °C (except where noted).

This data sheet contains a variety of typical and guaranteed performance data. The information supplied should not be interpreted as a complete list of circuit specifications. Customers considering the use of this, or other TCA GaAs ICs, for their design should obtain the current production specifications from Keysight. In this data sheet the term typical refers to the 50th percentile performance. For additional information and support email: mmic\_help@keysight.com.

**myKeysight**

myKeysight

[www.keysight.com/find/mykeysight](http://www.keysight.com/find/mykeysight)

A personalized view into the information most relevant to you.

**Three-Year Warranty**

[www.keysight.com/find/ThreeYearWarranty](http://www.keysight.com/find/ThreeYearWarranty)

Keysight's commitment to superior product quality and lower total cost of ownership. The only test and measurement company with three-year warranty standard on all instruments, worldwide.



**Keysight Assurance Plans**

[www.keysight.com/find/AssurancePlans](http://www.keysight.com/find/AssurancePlans)

Up to five years of protection and no budgetary surprises to ensure your instruments are operating to specification so you can rely on accurate measurements.



[www.keysight.com/quality](http://www.keysight.com/quality)

Keysight Technologies, Inc.  
DEKRA Certified ISO 9001:2008  
Quality Management System



**Keysight Channel Partners**

[www.keysight.com/find/channelpartners](http://www.keysight.com/find/channelpartners)

Get the best of both worlds: Keysight's measurement expertise and product breadth, combined with channel partner convenience.

[www.keysight.com/find/mmic](http://www.keysight.com/find/mmic)

For more information on Keysight Technologies' products, applications or services, please contact your local Keysight office. The complete list is available at: [www.keysight.com/find/contactus](http://www.keysight.com/find/contactus)

**Americas**

Canada	(877) 894 4414
Brazil	55 11 3351 7010
Mexico	001 800 254 2440
United States	(800) 829 4444

**Asia Pacific**

Australia	1 800 629 485
China	800 810 0189
Hong Kong	800 938 693
India	1 800 112 929
Japan	0120 (421) 345
Korea	080 769 0800
Malaysia	1 800 888 848
Singapore	1 800 375 8100
Taiwan	0800 047 866
Other AP Countries	(65) 6375 8100

**Europe & Middle East**

Austria	0800 001122
Belgium	0800 58580
Finland	0800 523252
France	0805 980333
Germany	0800 6270999
Ireland	1800 832700
Israel	1 809 343051
Italy	800 599100
Luxembourg	+32 800 58580
Netherlands	0800 0233200
Russia	8800 5009286
Spain	0800 000154
Sweden	0200 882255
Switzerland	0800 805353
	Opt. 1 (DE)
	Opt. 2 (FR)
	Opt. 3 (IT)
United Kingdom	0800 0260637

For other unlisted countries:  
[www.keysight.com/find/contactus](http://www.keysight.com/find/contactus)  
(BP-07-10-14)



## X-ON Electronics

Largest Supplier of Electrical and Electronic Components

*Click to view similar products for [keysight](#) manufacturer:*

Other Similar products are found below :

[34904A](#) [34465A](#) [U5404A](#) [U3606B](#) [U1461A](#) [U1281A](#) [U1251B](#) [U1194A](#) [U1185A](#) [E3644A](#) [E3640A](#) [E3634A](#) [DSOX3014T](#) [10833F](#)  
[U1117A](#) [U1232A](#) [U1452A](#) [82350C](#) [34460A](#) [N6745B](#) [N2782B](#) [N6773A](#) [10074D](#) [E3634A/0E3/902](#) [DAQA194A](#) [33511B/903](#) [N2820A](#)  
[N6734B](#) [U1780A/903](#) [U8001A/0EM/903](#) [DAQM905A](#) [E3640A/0EM/903](#) [DAQM903A](#) [N6743B](#) [E3634A/0EM/903](#) [E3633A/0EM/903](#)  
[N4837A](#) [N2891A](#) [E3648A/0E3/902](#) [E3642A/0EM/903](#) [U2781A](#) [33522B](#) [U1115A](#) [U1594A](#) [E36313A](#) [E363GPBU](#) [N1294A-001](#) [U2941A-](#)  
[107](#) [DSOX1204A+D1200BW2A](#) [E36232A/903](#)