

799-015
Low Profile EMI Backshell
for 790-024 and 790-025 Cable Connectors
How To Order







799-015 Low Profile EMI Backshell
FOR 790-024 AND 790-025 CABLE CONNECTORS

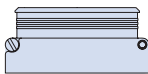

Attach cable braid to connector with 799-015 adapters. These adapters fit securely into a groove on 790-024 and 790-025 cable connectors. Terminate shields with **BAND-IT**[®] stainless steel straps. Elliptical cable entry provides room for large wire bundles. Machined T6061 aluminum adapters consist of two interlocking housings, two fillister head screws and two lockwashers. These lightweight, space-saving adapters are compatible with captive screws on connector flange. This adapter is non environmental. Fill with potting compound to prevent water intrusion.

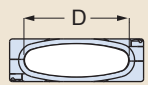
How To Order

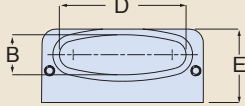
How To Order									
Sample Part Number									
799-015T	M	B	02	N	02				
Part Number	Shell Finish	Shell Size	Cable Entry Size	Band Option	Optional Height Code*				
 799-015T Top Entry  799-015S Side Entry	<p>M Electroless Nickel <i>general purpose applications</i></p> <p>MT Nickel-PTFE <i>1000 Hour Grey™ maximum corrosion protection and durability (non-reflective grey)</i></p> <p>ZNU Zinc-Nickel with Black Chromate <i>tactical applications (non-reflective black)</i></p> <p>Additional shell finishes are listed on page C-9.</p>	<p>A</p> <p>B</p> <p>C</p> <p>D</p> <p>E</p> <p>F</p> <p>G</p> <p>H</p> <p>J</p> <p>K</p> <p>L</p> <p>M</p>	 Cable Entry Code D Shell Size In. mm.	<p>N No Band Supplied</p> <p>M BAND-IT[™] Micro-Band Included. .125 (3.18) Wide.</p> 	 Height Code E In. mm.				
			01		.140	3.56	A-M	01	.810 20.6
			02		.290	7.37	B-M	02	.940 23.9
			03		.440	11.18	C-M	03	1.060 26.9
			04		.540	13.72	D-M	04	1.190 30.2
			05		.690	17.53	E-M	05	1.310 33.3
			06		.810	20.57	F-M	06	1.440 36.6
			07		1.000	25.40	H-M	07	1.560 39.6
			08		1.190	30.23	H-M	08	1.690 42.9
			09		1.305	33.15	K-M	09	1.810 46.0
			10		1.420	36.07	K-M	10	1.940 49.3
			11		1.600	40.64	K	Omit	.690 17.5
12	1.500	38.10	K and M						

* For Top Entry Style T, shortest height code of E = .69" is limited to shell & entry size combinations A01, B02, C03, D04, E05, F06, G06, H08, J08, K11, L10 & M12 to ensure adequate wire clearance. Contact factory for other combinations. For Side Entry Style S, shortest height code E is acceptable for all shell & entry size combinations except consideration for 12AWG wire bend radius.

Dimensions in Inches (millimeters) are subject to change without notice.



799-015
Low Profile EMI Backshell
for 790-024 and 790-025 Cable Connectors
How To Order

799-015 Low Profile EMI Backshell

STYLE T - TOP ENTRY

STYLE S - SIDE ENTRY

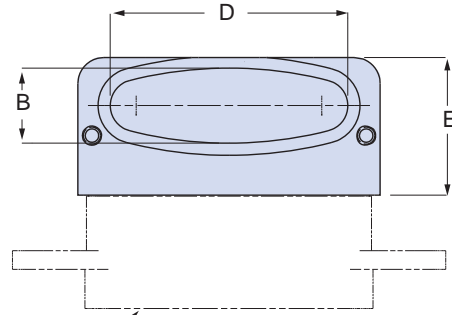
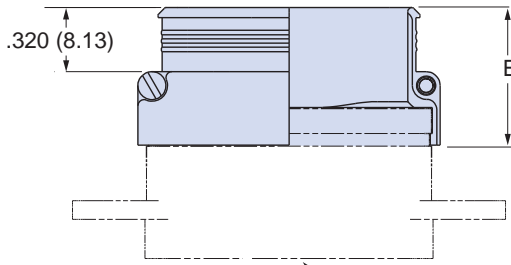
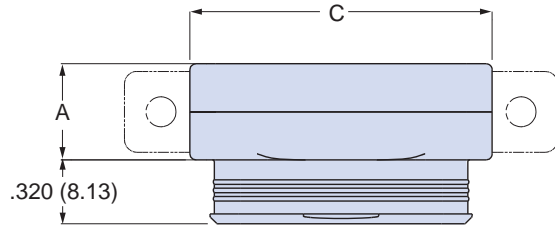
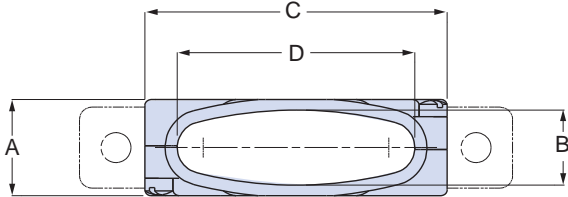

CONNECTOR SHOWN FOR REFERENCE - NOT SUPPLIED

799-015 DIMENSIONS

Shell Size	A Max.		B		C Max.		Available Entries
	In.	mm.	In.	mm.	In.	mm.	
A	.385	9.78	.270	6.86	.485	12.32	01
B	.385	9.78	.270	6.86	.635	16.13	01 thru 02
C	.385	9.78	.270	6.86	.785	19.94	01 thru 03
D	.385	9.78	.270	6.86	.885	22.48	01 thru 04
E	.385	9.78	.270	6.86	1.035	26.29	01 thru 05
F	.385	9.78	.270	6.86	1.185	30.10	01 thru 06
G	.465	11.81	.350	8.89	1.145	29.08	01 thru 06
H	.495	12.57	.380	9.65	1.525	38.74	01 thru 08
J	.385	9.78	.270	6.86	1.545	39.24	01 thru 08
K	.385	9.78	.270	6.86	1.945	49.40	01 thru 11
L	.495	12.57	.380	9.65	1.765	44.83	01 thru 10
M	.555		.440		1.830		01 thru 10, 12

ENTRY SIZE

Entry Size	D		Available Sizes
	In.	mm.	
01	.140	3.56	A Thru L
02	.290	7.37	B thru L
03	.440	11.18	C thru L
04	.540	13.72	D thru L
05	.690	17.53	E thru L
06	.810	20.57	F, H, J, K, L
07	1.000	25.40	H thru L
08	1.190	30.23	H Thru L
09	1.305	33.15	K, L
10	1.420	36.07	K, L
11	1.600	40.64	K
12	1.500	38.10	K and M

HEIGHT CODE

CODE	E	
	In.	mm.
01	.810	20.6
02	.940	23.9
03	1.060	26.9
04	1.190	30.2
05	1.310	33.3
06	1.440	36.6
07	1.560	39.6
08	1.690	42.9
09	1.810	46.0
10	1.940	49.3
11	1.600	40.6
12	1.500	38.1

Component	Material	Finish
Backshell	Aluminum Alloy	See table below
Hardware	Stainless Steel	Passivated

Dimensions in Inches (millimeters) are subject to change without notice.

X-ON Electronics

Largest Supplier of Electrical and Electronic Components

Click to view similar products for [D-Sub Backshells](#) category:

Click to view products by [Glenair](#) manufacturer:

Other Similar products are found below :

[173114-0084](#) [173112-1658](#) [600X51137X](#) [600X54009X](#) [66241-12A](#) [M85049/48-1-2](#) [M85049/48-3-5F](#) [M85049/6-38N](#) [M85049/86-12N03](#)
[70.350.0636.4](#) [70.350.2435.1](#) [72.350.1035.2](#) [72.352.2435.1](#) [73.359.4035.3](#) [799-015TMH07M](#) [799-015TMH08N](#) [FKH1RE](#) [829472-1](#) [F-](#)
[PHG-1E](#) [F-PHG-3E](#) [F-PHG-4E](#) [F-PHR-4E](#) [PCS-E20W](#) [8655MHRA0901KLF](#) [8655MHRA2501KLF](#) [958-009-010R011](#) [970-015-040R011](#)
[970-025-030R121](#) [970-025-040R011](#) [971-009-030R121](#) [971-009-040R011](#) [971-015-040R011](#) [971-025-040R011](#) [GS85049/38-25M](#) [975T009-](#)
[020R121](#) [975T015-020R121](#) [1-21986-2](#) [1-21986-5](#) [DB-20962](#) [DE-C8-J9-F4-1R](#) [DE-C8-J9-F5-1R](#) [DPH-B-003](#) [1437013-9](#) [1484402-8](#)
[MS3057-10A](#) [156-3025-EX](#) [MS3417-16C](#) [16-500800](#) [165X02659X](#) [165X03329A](#)