

Description: Bluetooth, WiFi Antenna

Series: The Blue Dot

PART NUMBER: W3092



Features:

- Chip Antenna
- Frequency:
2400MHz ~ 2483MHz
- Low profile
2.0mm(Length) x 1.2mm(Width)
x 0.55mm(Thickness)

Applications:

- WLAN
- 802.11b/g
- Bluetooth
- Zigbee, ISM 2.4GHz

All dimensions are in mm / inches

Issue: 1639

In the effort to improve our products, we reserve the right to make changes judged to be necessary.

CONFIDENTIAL AND PROPRIETARY INFORMATION

This document contains confidential and proprietary information of Pulse Electronics, Inc. (Pulse) and is protected by copyright, trade secret and other state and federal laws. Its receipt or possession does not convey any rights to reproduce, disclose its contents, or to manufacture, use or sell anything it may describe. Reproduction, disclosure or use without specific written authorization of Pulse is strictly forbidden.

For more information:

Pulse Worldwide Headquarters
12220 World Trade Drive
San Diego, CA 92128
USA
Tel: 1-858-674-8100

Pulse/Larsen Antennas
18110 SE 34th St Bldg 2 Suite 250
Vancouver, WA 98683
USA
Tel: 1-360-944-7551

Europe Headquarters
Pulse GmbH & Do, KG
Zeppelinstrasse 15
Herrenberg, Germany
Tel: 49 7032 7806 0

Pulse (Suzhou) Wireless Products Co, Inc.
99 Huo Ju Road(#29 Bldg, 4th Phase
Suzhou New District
Jiangsu Province, Suzhou 215009 PR China
Tel: 86 512 6807 9998



Description: Bluetooth, WiFi Antenna**Series:** The Blue Dot**PART NUMBER:** W3092**ELECTRICAL SPECIFICATIONS**

Frequency	2400-2483	MHz
Nominal Impedance	50	Ω
VSWR	3	max
Gain (Typ.)	0.89	dBi
Efficiency(Typ.)	50	%
Polarization	Linear	

Issue: 1639

In the effort to improve our products, we reserve the right to make changes judged to be necessary.

CONFIDENTIAL AND PROPRIETARY INFORMATION

This document contains confidential and proprietary information of Pulse Electronics, Inc. (Pulse) and is protected by copyright, trade secret and other state and federal laws. Its receipt or possession does not convey any rights to reproduce, disclose its contents, or to manufacture, use or sell anything it may describe. Reproduction, disclosure or use without specific written authorization of Pulse is strictly forbidden.

Description: Bluetooth, WiFi Antenna**Series:** The Blue Dot**PART NUMBER:** W3092**MECHANICAL SPECIFICATIONS**

Weight	0.005 g
Size	2.0x1.2x0.55 mm

ENVIRONMENTAL SPECIFICATIONS

Operating temperature	-40/+105 ° C
High temperature resistance	150 ° C, 1000 hours
Low temperature resistance	-40 ° C, 1000 hours
Humidity	85%R.H. 85±5 ° C, 1000 cycles
Soldering heat resistance	260 ° C 10s
Thermal shock	-40/+105 ° C
Storage condition	
At warehouse	0-30 ° C, <60%R.H.,shoule be used<1 year
On board	-40 ~85 ° C, <85%R.H

Issue: 1639

In the effort to improve our products, we reserve the right to make changes judged to be necessary.

CONFIDENTIAL AND PROPRIETARY INFORMATION

This document contains confidential and proprietary information of Pulse Electronics, Inc. (Pulse) and is protected by copyright, trade secret and other state and federal laws. Its receipt or possession does not convey any rights to reproduce, disclose its contents, or to manufacture, use or sell anything it may describe. Reproduction, disclosure or use without specific written authorization of Pulse is strictly forbidden.

Description: Bluetooth, WiFi Antenna

Series: The Blue Dot

PART NUMBER: W3092

MECHANICAL DRAWING

Pad for SMT process

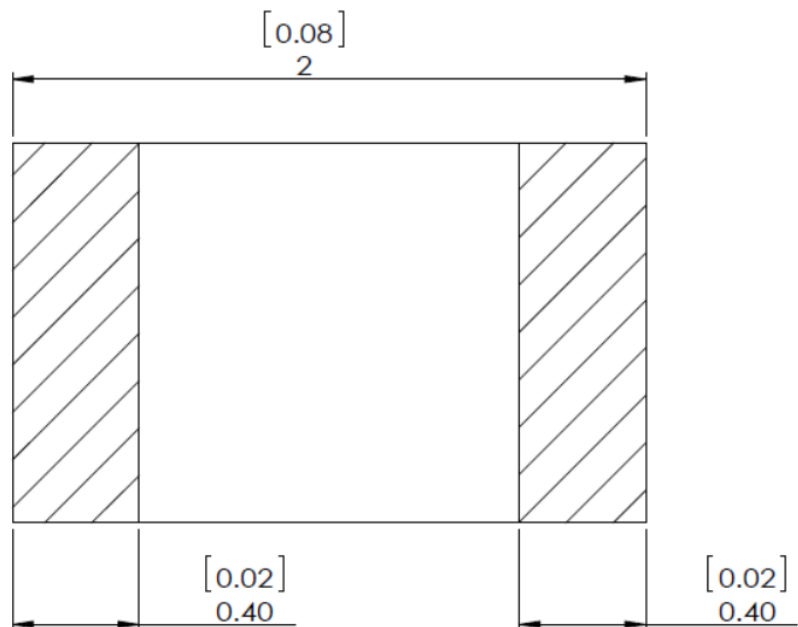
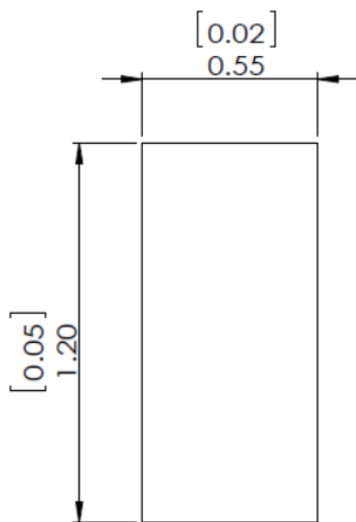
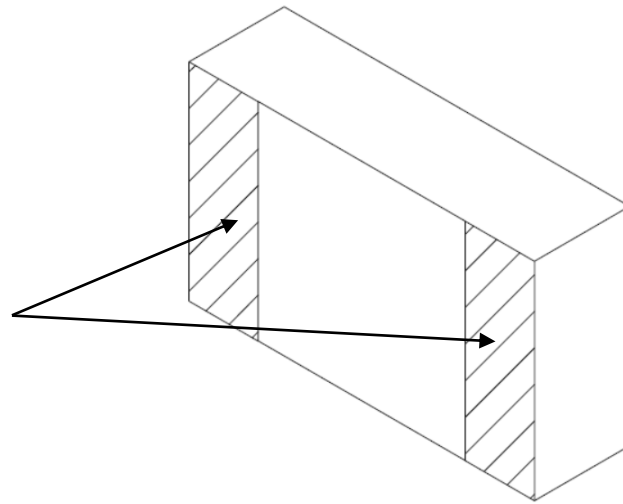

Issue: 1639

In the effort to improve our products, we reserve the right to make changes judged to be necessary.

CONFIDENTIAL AND PROPRIETARY INFORMATION

This document contains confidential and proprietary information of Pulse Electronics, Inc. (Pulse) and is protected by copyright, trade secret and other state and federal laws. Its receipt or possession does not convey any rights to reproduce, disclose its contents, or to manufacture, use or sell anything it may describe. Reproduction, disclosure or use without specific written authorization of Pulse is strictly forbidden.

Description: Bluetooth, WiFi Antenna

Series: The Blue Dot

PART NUMBER: W3092

OTHER SPECIFICATIONS

Recommended PCB layout(Unit:mm)

PCB size(L X W X T): 110 X 55 X 1mm

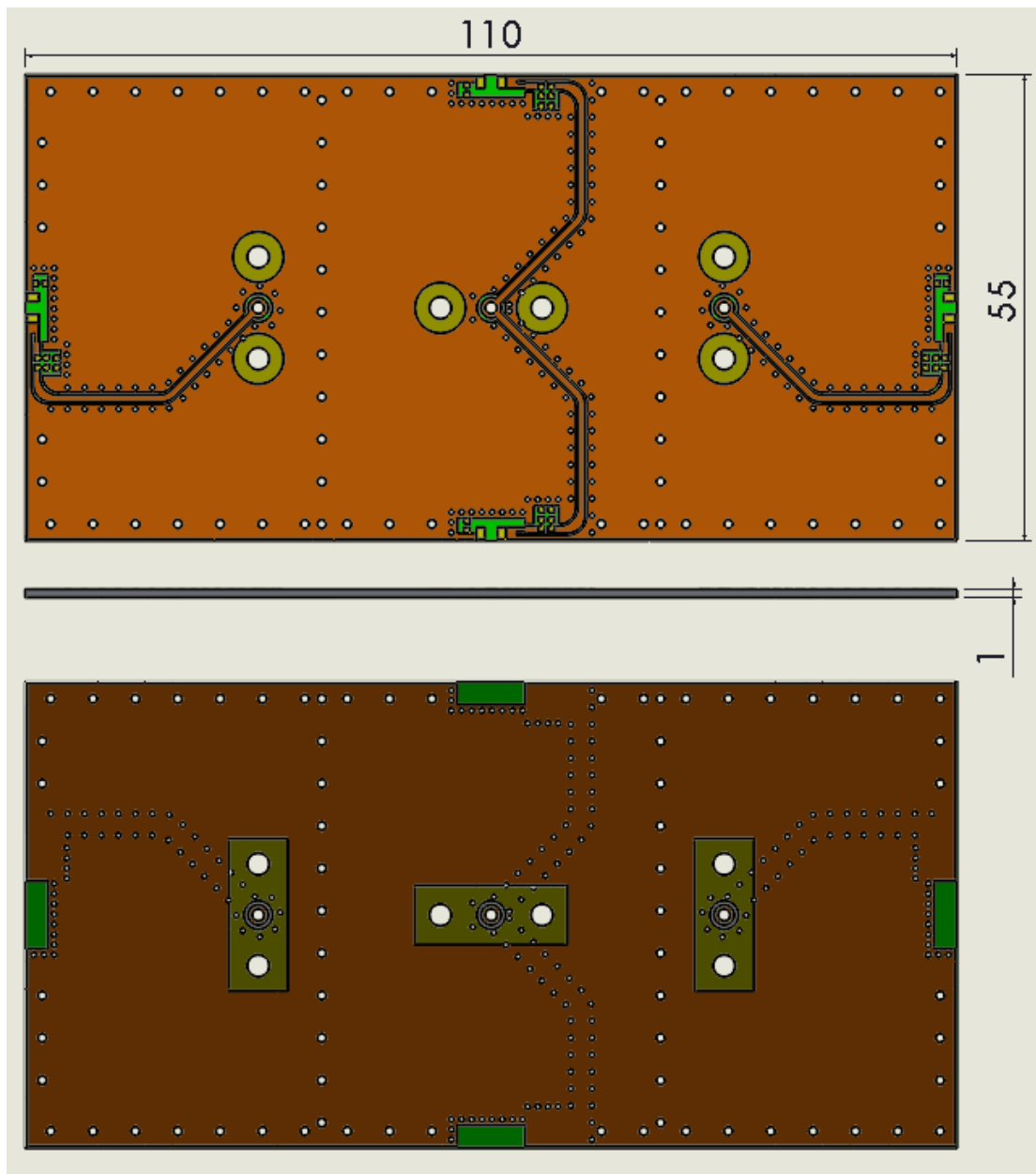

Issue: 1639

In the effort to improve our products, we reserve the right to make changes judged to be necessary.

CONFIDENTIAL AND PROPRIETARY INFORMATION

This document contains confidential and proprietary information of Pulse Electronics, Inc. (Pulse) and is protected by copyright, trade secret and other state and federal laws. Its receipt or possession does not convey any rights to reproduce, disclose its contents, or to manufacture, use or sell anything it may describe. Reproduction, disclosure or use without specific written authorization of Pulse is strictly forbidden.

Description: Bluetooth, WiFi Antenna

Series: The Blue Dot

PART NUMBER: W3092

OTHER SPECIFICATIONS

PCB top side layout

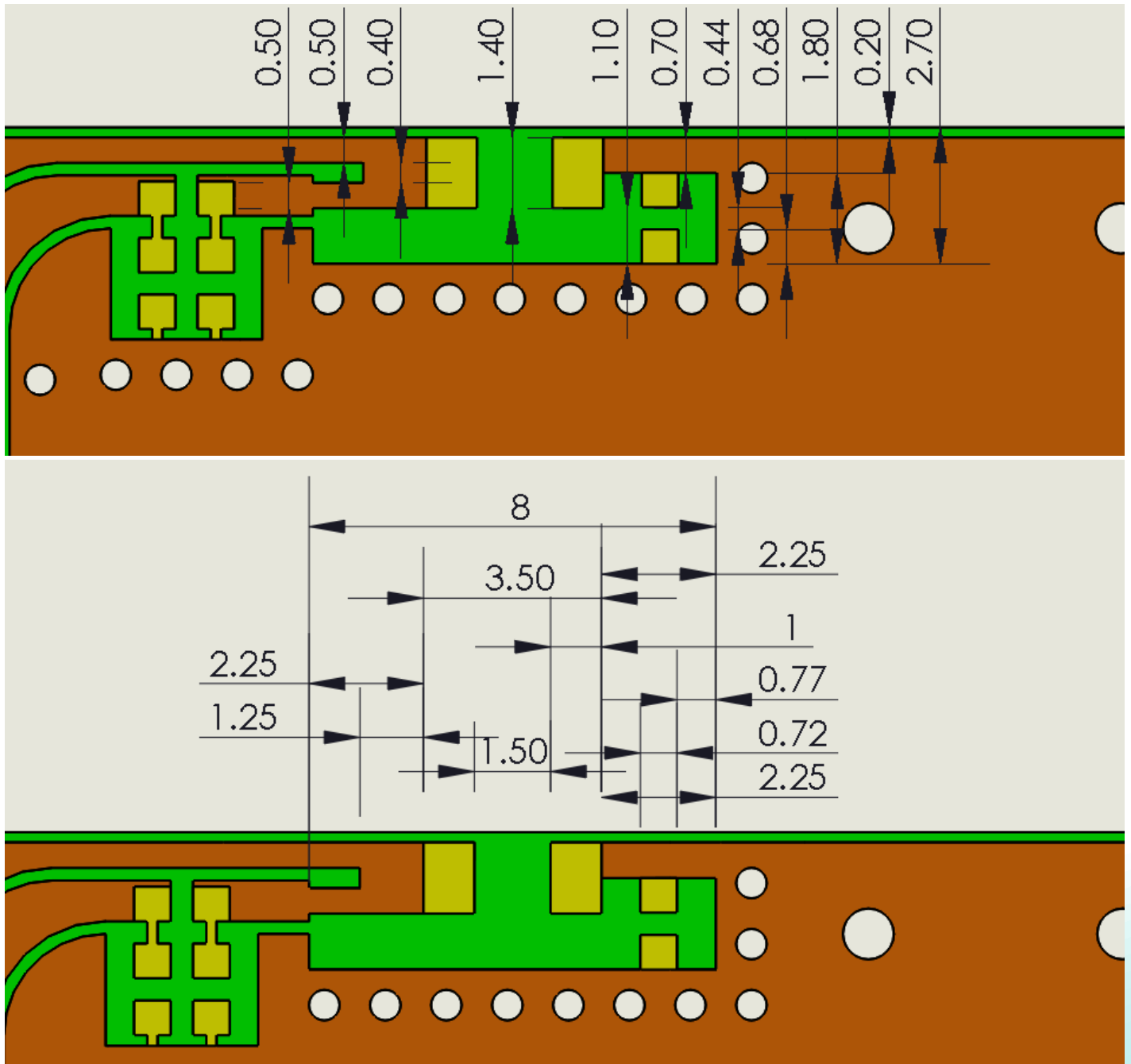

Issue: 1639

In the effort to improve our products, we reserve the right to make changes judged to be necessary.

CONFIDENTIAL AND PROPRIETARY INFORMATION

This document contains confidential and proprietary information of Pulse Electronics, Inc. (Pulse) and is protected by copyright, trade secret and other state and federal laws. Its receipt or possession does not convey any rights to reproduce, disclose its contents, or to manufacture, use or sell anything it may describe. Reproduction, disclosure or use without specific written authorization of Pulse is strictly forbidden.

Description: Bluetooth, WiFi Antenna

Series: The Blue Dot

PART NUMBER: W3092

OTHER SPECIFICATIONS

PCB bottom side layout

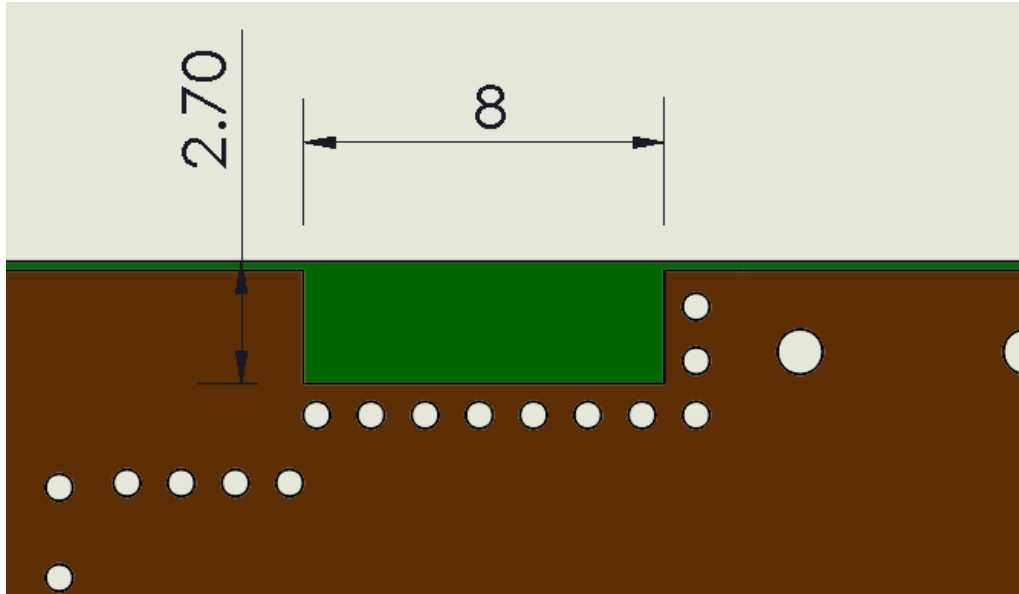

*Clearance 8mm x 2.7mm : All metallization should be removed from all PCB layers.

Recommended matching circuit

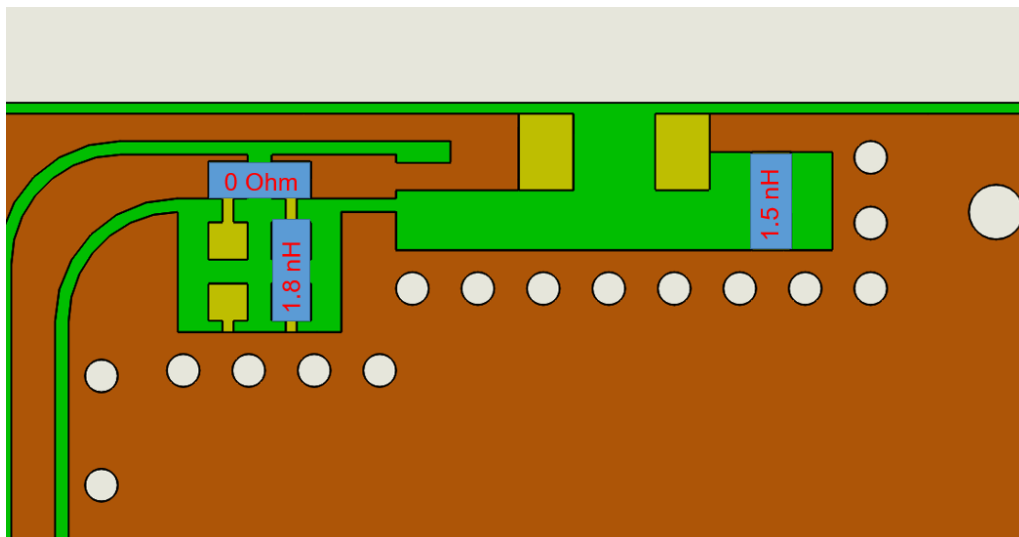

Issue: 1639

In the effort to improve our products, we reserve the right to make changes judged to be necessary.

CONFIDENTIAL AND PROPRIETARY INFORMATION

This document contains confidential and proprietary information of Pulse Electronics, Inc. (Pulse) and is protected by copyright, trade secret and other state and federal laws. Its receipt or possession does not convey any rights to reproduce, disclose its contents, or to manufacture, use or sell anything it may describe. Reproduction, disclosure or use without specific written authorization of Pulse is strictly forbidden.

Description: Bluetooth, WiFi Antenna

Series: The Blue Dot

PART NUMBER: W3092

OTHER SPECIFICATIONS

Recommended reflow soldering

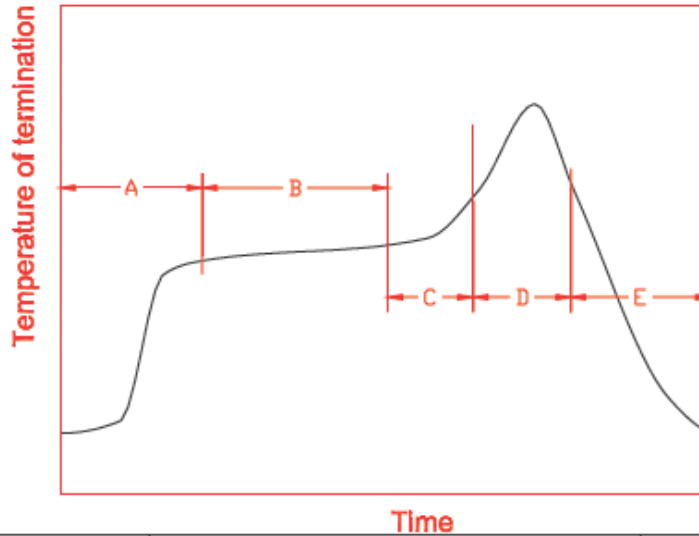

Time			
A	1 st rising temperature	The normal to Preheating temperature	30s to 60s
B	Preheating	140°C to 160°C	60s to 120s
C	2 nd rising temperature	Preheating to 200°C	20s to 40s
D	Main heating	if 220°C	50s~60s
		if 230°C	40s~50s
		if 240°C	30s~40s
		if 250°C	20s~40s
		if 260°C	20s~40s
E	Regular cooling	200°C to 100°C	1°C/s ~ 4°C/s

*reference: J-STD-020C

(1) Soldering gun procedure

Note the follows, in case of using solder gun for replacement.

(a) The tip temperature must be less than 350°C for the period within 3 seconds by using soldering gun under 30 W.

(b) The soldering gun tip shall not touch this product directly.

(2) Soldering volume

Note that excess of soldering volume will easily get crack the body of this product.

Issue: 1639

In the effort to improve our products, we reserve the right to make changes judged to be necessary.

CONFIDENTIAL AND PROPRIETARY INFORMATION

This document contains confidential and proprietary information of Pulse Electronics, Inc. (Pulse) and is protected by copyright, trade secret and other state and federal laws. Its receipt or possession does not convey any rights to reproduce, disclose its contents, or to manufacture, use or sell anything it may describe. Reproduction, disclosure or use without specific written authorization of Pulse is strictly forbidden.

Description: Bluetooth, WiFi Antenna

Series: The Blue Dot

PART NUMBER: W3092

CHARTS

VSWR

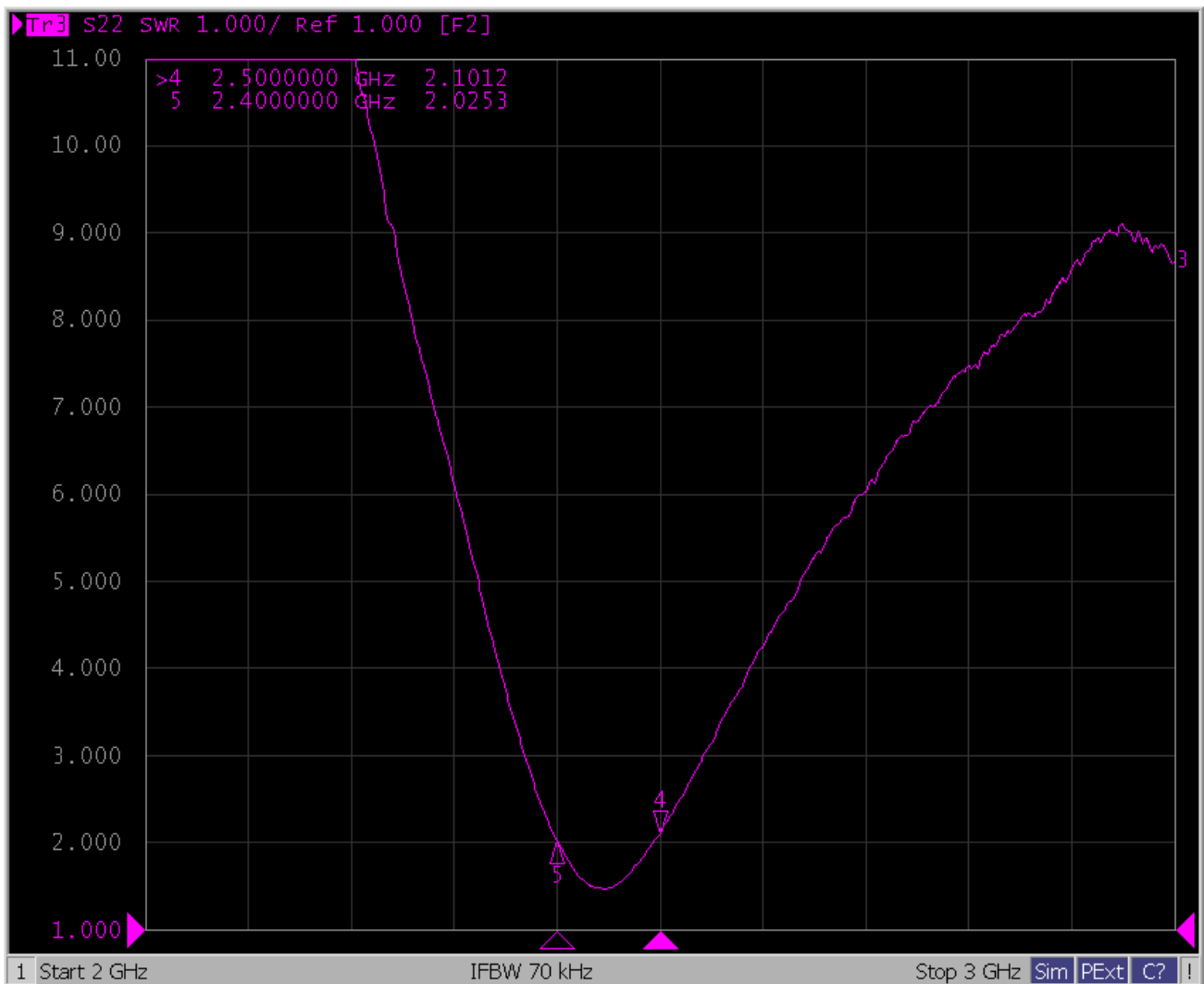

Issue: 1639

In the effort to improve our products, we reserve the right to make changes judged to be necessary.

CONFIDENTIAL AND PROPRIETARY INFORMATION

This document contains confidential and proprietary information of Pulse Electronics, Inc. (Pulse) and is protected by copyright, trade secret and other state and federal laws. Its receipt or possession does not convey any rights to reproduce, disclose its contents, or to manufacture, use or sell anything it may describe. Reproduction, disclosure or use without specific written authorization of Pulse is strictly forbidden.

Description: Bluetooth, WiFi Antenna

Series: The Blue Dot

PART NUMBER: W3092

CHARTS

Efficiency

Efficiency vs Frequency measured with demo board

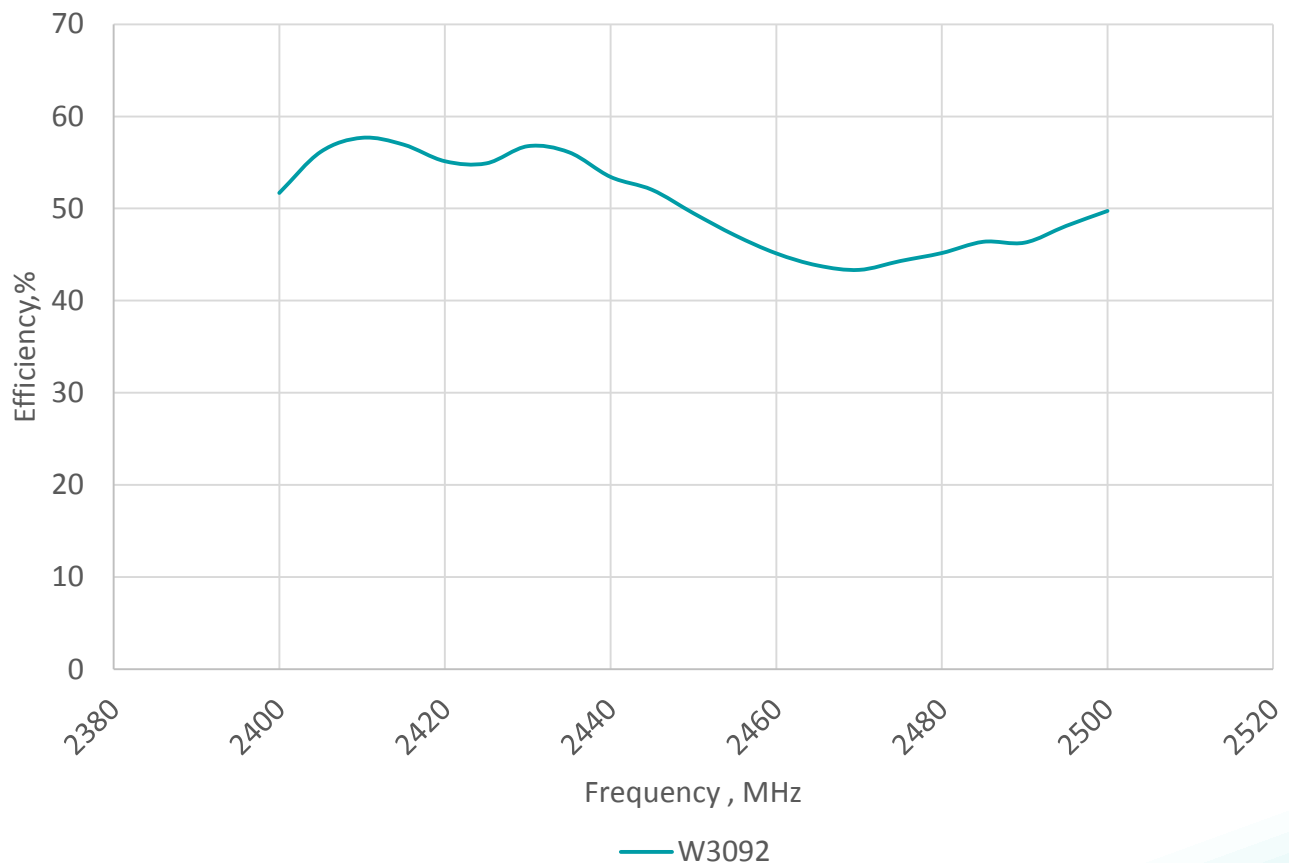

Issue: 1639

In the effort to improve our products, we reserve the right to make changes judged to be necessary.

CONFIDENTIAL AND PROPRIETARY INFORMATION

This document contains confidential and proprietary information of Pulse Electronics, Inc. (Pulse) and is protected by copyright, trade secret and other state and federal laws. Its receipt or possession does not convey any rights to reproduce, disclose its contents, or to manufacture, use or sell anything it may describe. Reproduction, disclosure or use without specific written authorization of Pulse is strictly forbidden.



Description: Bluetooth, WiFi Antenna

Series: The Blue Dot

PART NUMBER: W3092

CHARTS

Peak Gain

Peak Gain vs Frequency measured with demo board

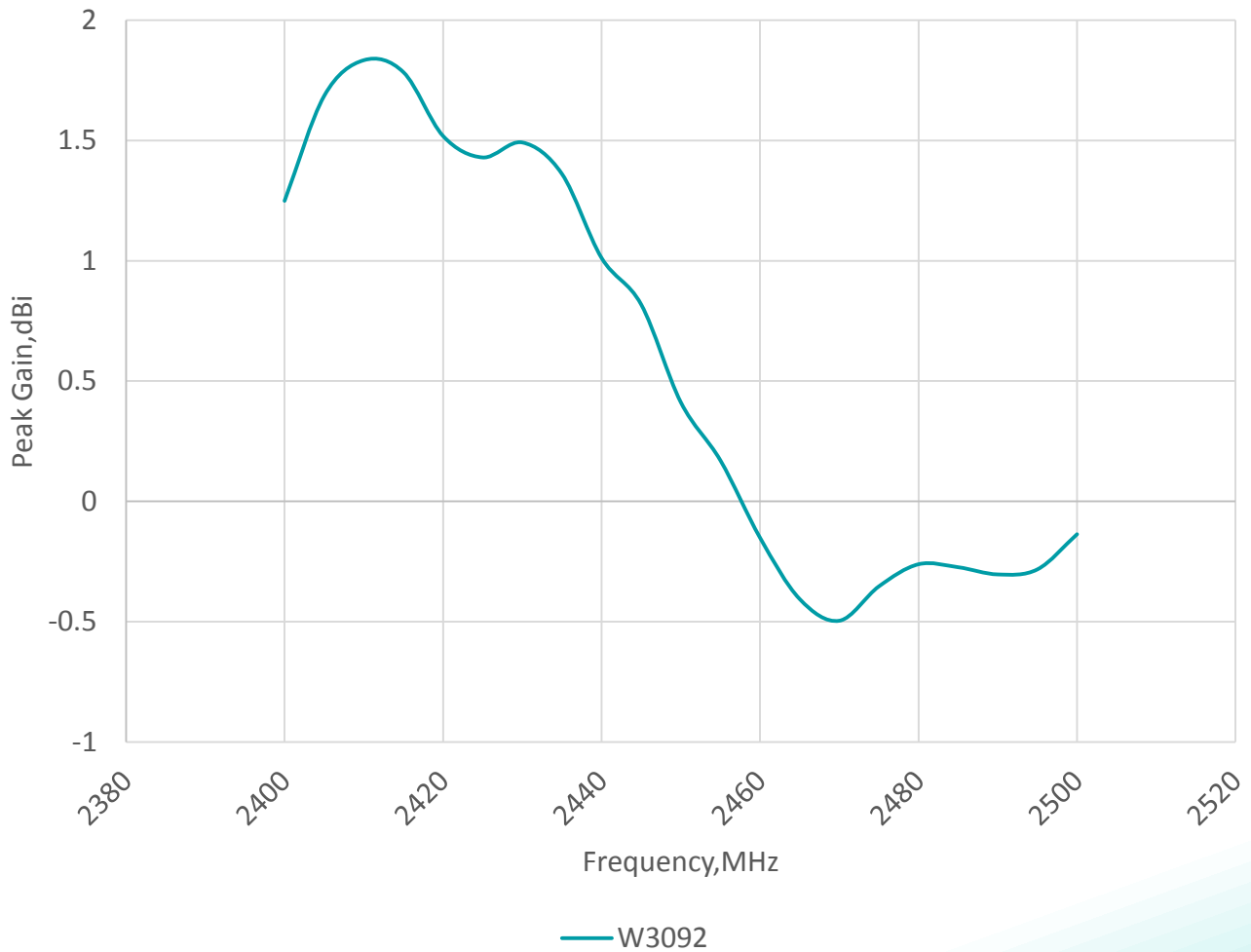

Issue: 1639

In the effort to improve our products, we reserve the right to make changes judged to be necessary.

CONFIDENTIAL AND PROPRIETARY INFORMATION

This document contains confidential and proprietary information of Pulse Electronics, Inc. (Pulse) and is protected by copyright, trade secret and other state and federal laws. Its receipt or possession does not convey any rights to reproduce, disclose its contents, or to manufacture, use or sell anything it may describe. Reproduction, disclosure or use without specific written authorization of Pulse is strictly forbidden.

Description: Bluetooth, WiFi Antenna

Series: The Blue Dot

PART NUMBER: W3092

CHARTS

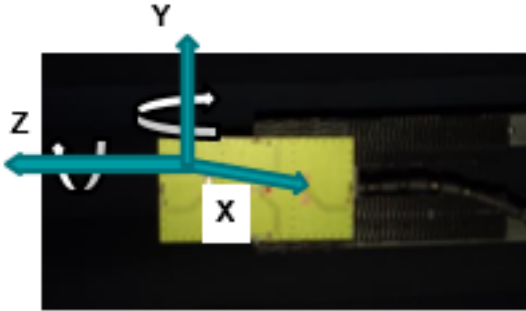

Radiation pattern

XY Plane

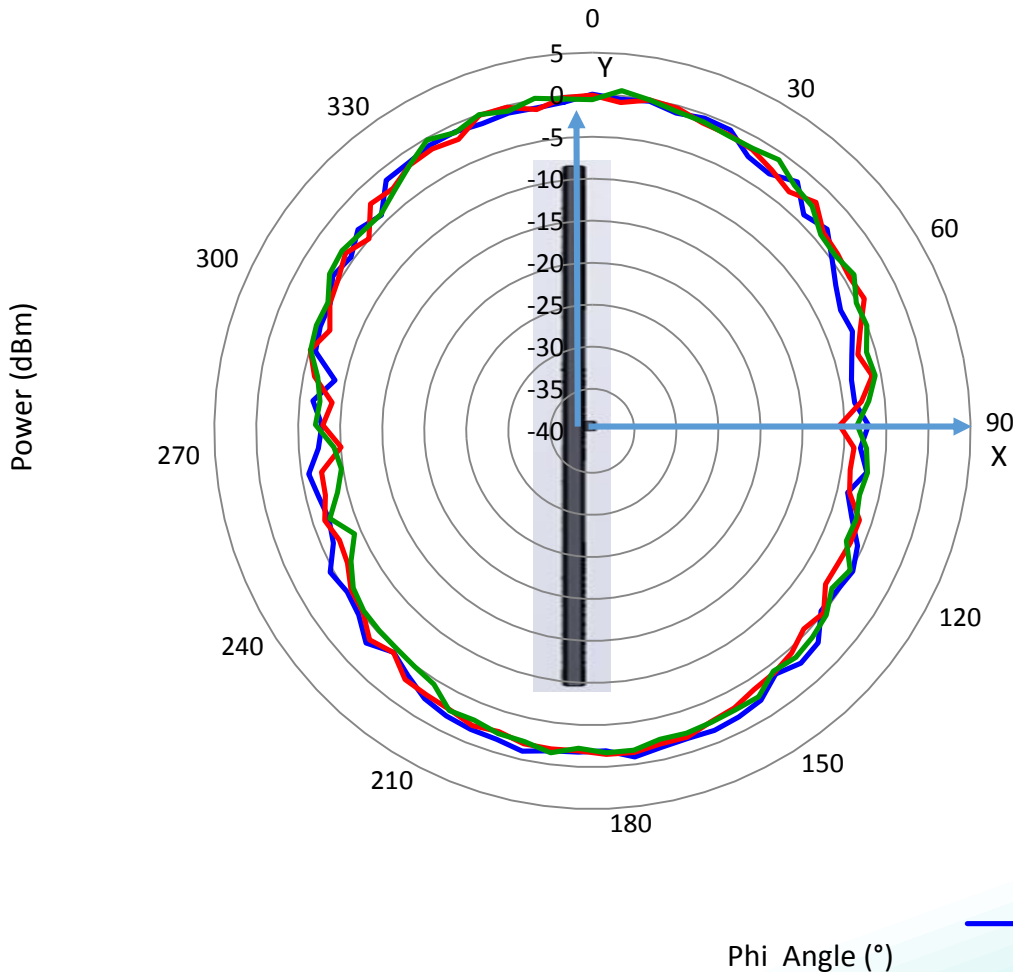

2400MHz
Avg (dBi) = -4.07
Peak (dBi) = -2.05
Avg -3 (deg) = 285
2450MHz
Avg (dBi) = -3.89
Peak (dBi) = -1.39
Avg -3 (deg) = 265
2480MHz
Avg (dBi) = -3.32
Peak (dBi) = -1.32
Avg -3 (deg) = 265

— 2400MHz — 2450MHz — 2500MHz

Phi Angle (°)

Issue: 1639

In the effort to improve our products, we reserve the right to make changes judged to be necessary.

CONFIDENTIAL AND PROPRIETARY INFORMATION

This document contains confidential and proprietary information of Pulse Electronics, Inc. (Pulse) and is protected by copyright, trade secret and other state and federal laws. Its receipt or possession does not convey any rights to reproduce, disclose its contents, or to manufacture, use or sell anything it may describe. Reproduction, disclosure or use without specific written authorization of Pulse is strictly forbidden.

Description: Bluetooth, WiFi Antenna

Series: The Blue Dot

PART NUMBER: W3092

CHARTS

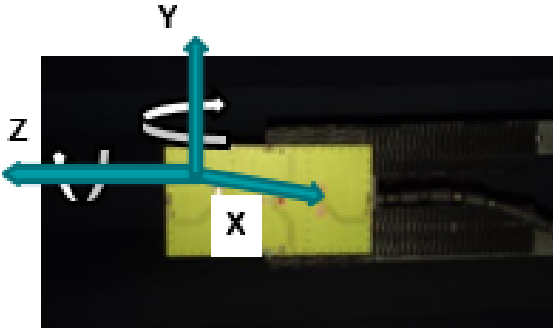

Radiation pattern

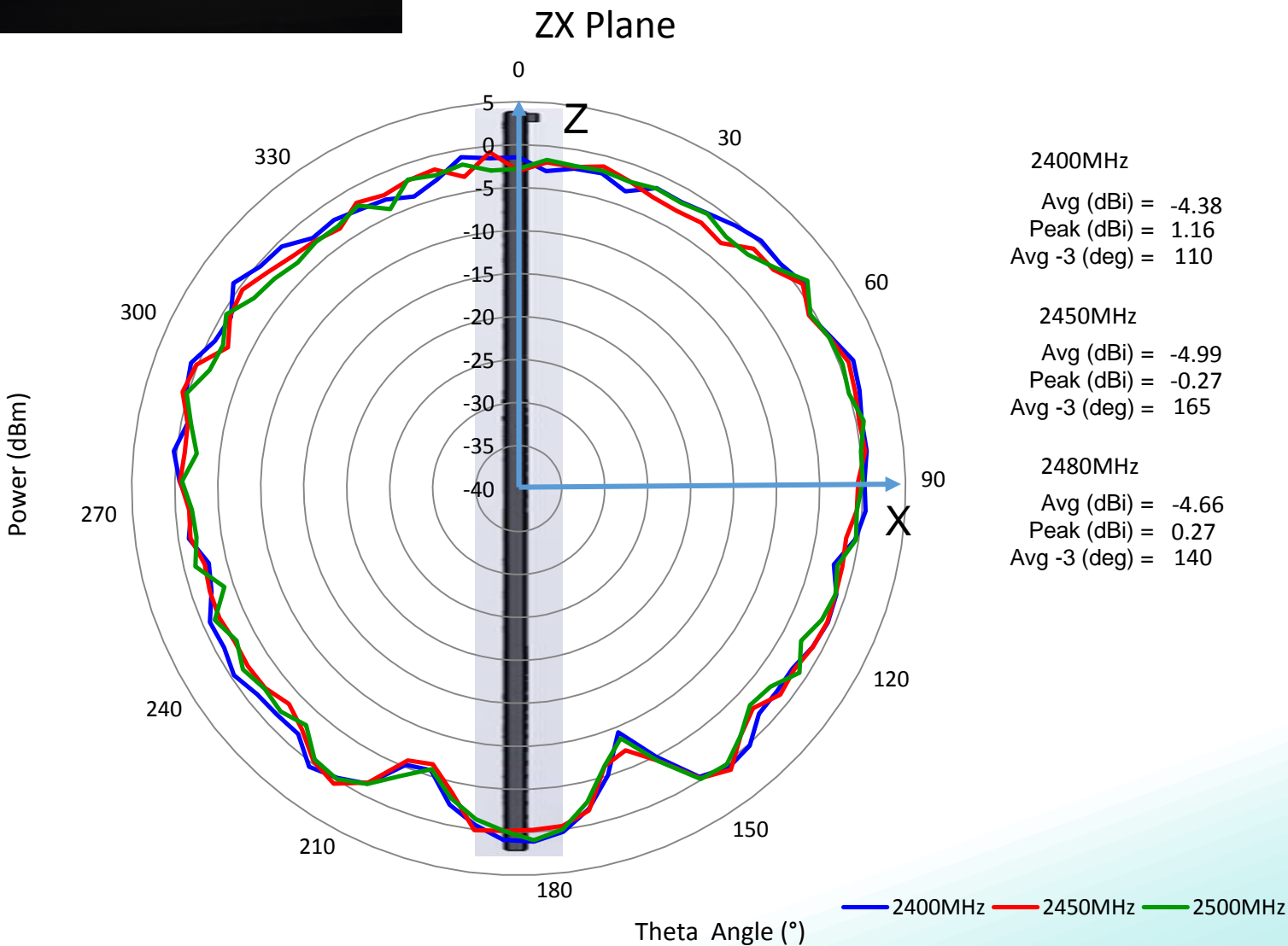

Issue: 1639

In the effort to improve our products, we reserve the right to make changes judged to be necessary.

CONFIDENTIAL AND PROPRIETARY INFORMATION

This document contains confidential and proprietary information of Pulse Electronics, Inc. (Pulse) and is protected by copyright, trade secret and other state and federal laws. Its receipt or possession does not convey any rights to reproduce, disclose its contents, or to manufacture, use or sell anything it may describe. Reproduction, disclosure or use without specific written authorization of Pulse is strictly forbidden.

Description: Bluetooth, WiFi Antenna

Series: The Blue Dot

PART NUMBER: W3092

CHARTS

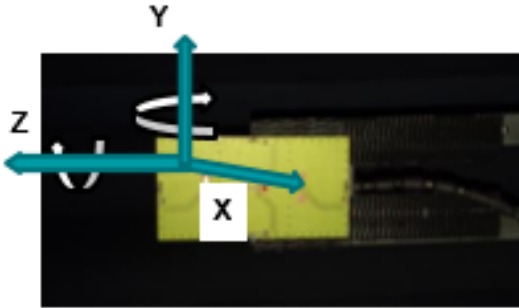

Radiation pattern

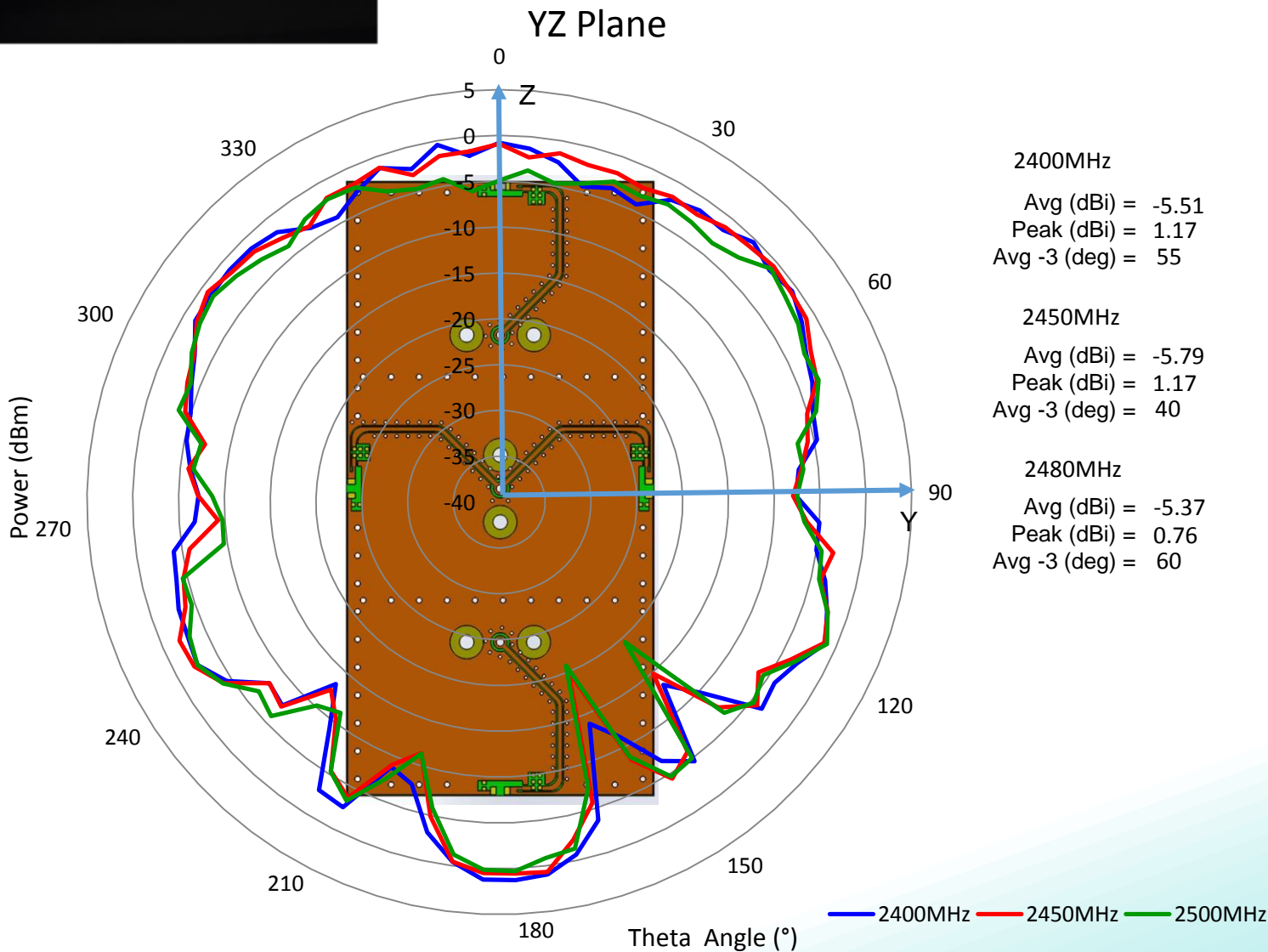

Issue: 1639

In the effort to improve our products, we reserve the right to make changes judged to be necessary.

CONFIDENTIAL AND PROPRIETARY INFORMATION

This document contains confidential and proprietary information of Pulse Electronics, Inc. (Pulse) and is protected by copyright, trade secret and other state and federal laws. Its receipt or possession does not convey any rights to reproduce, disclose its contents, or to manufacture, use or sell anything it may describe. Reproduction, disclosure or use without specific written authorization of Pulse is strictly forbidden.

Description: Bluetooth, WiFi Antenna

Series: The Blue Dot

PART NUMBER: W3092

PACKAGING

Taping Package and Label Marking: (unit: mm)

- (1) Quantity/Reel: 5000pcs/Reel
- (2) Carrier tape dimensions

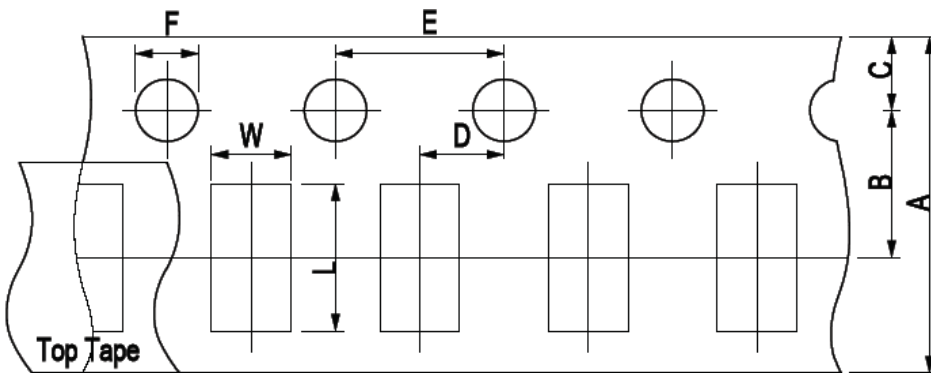

Type	A	B	C	D	E	F	L	W
ACA2012	8.00±0.30	3.50±0.05	1.75±0.10	2.00±0.05	4.00±0.10	1.50±0.10	2.30±0.10	1.55±0.10

(3) Taping reel dimensions

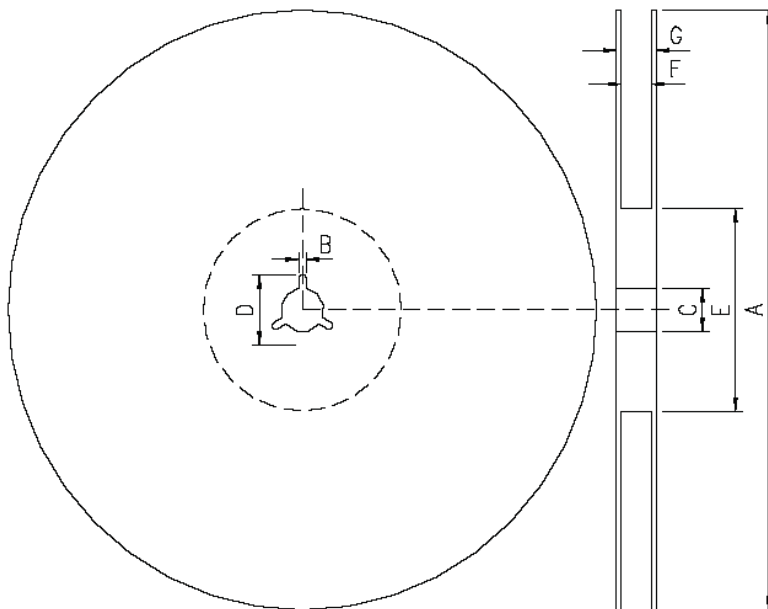

A	178.0±2.0
B	2.0±0.5
C	13.0±0.5
D	21.0±0.8
E	62.0±1.5
F	9.0±0.5
G	13.0±1.0

Issue: 1639

In the effort to improve our products, we reserve the right to make changes judged to be necessary.

CONFIDENTIAL AND PROPRIETARY INFORMATION

This document contains confidential and proprietary information of Pulse Electronics, Inc. (Pulse) and is protected by copyright, trade secret and other state and federal laws. Its receipt or possession does not convey any rights to reproduce, disclose its contents, or to manufacture, use or sell anything it may describe. Reproduction, disclosure or use without specific written authorization of Pulse is strictly forbidden.

X-ON Electronics

Largest Supplier of Electrical and Electronic Components

Click to view similar products for [Antennas](#) category:

Click to view products by [Pulse](#) manufacturer:

Other Similar products are found below :

[CCT FM1](#) [ABFT](#) [AD-NM-SMAF 001-0021](#) [CTC110](#) [MAF94149](#) [EXE902SF](#) [MMCX-SMA-100](#) [PDQ24496-91NF](#) [GAN30084EU](#) [930-033-R](#) [A08-HABUF-P5I](#) [AAF95035](#) [DG-ANT-20DP-BG-B](#) [APAMPGJ-141](#) [1513563-1](#) [OF86315-FNF](#) [OP24516DS-91NM](#) [A09-HASM-7](#) [EXE902MD](#) [EXE902SM](#) [SPDA17806/2170LAR](#) [APAMPG-117](#) [GPS1575SP26-004](#) [GPS15MGSMA](#) [CMD69273P-30NF](#) [CMQ69273-30NF](#) [RD2458-5-OTDR-NM](#) [RD2458-5-RSMA](#) [TRAB24/49003](#) [W4120ER5000](#) [W6102B0100](#) [YE572113-30RSMM](#) [108-00014-50](#) [SPDA17RP918](#) [OP24516SX-91NM](#) [OP24516SX-91RSMM](#) [CMQ69273P-30NF](#) [CMS69273-30NF](#) [CMS69273P-30NF](#) [TRAB24003N](#) [TRAB24003NP](#) [TRAB8213NP](#) [TRAB8903](#) [A09-Y8NF](#) [A09-Y11NF](#) [A09-HSM-7](#) [A09-F8NF-M](#) [A09-F5NF-M](#)