

FASTON Tabs

312 and 250 Series (High Temperature 700° F / 371° C Max.)

TE offers a variety of FASTON tabs in an assortment of configurations. The product line includes various weld type tabs, stud mounted tabs and wire crimp tabs. Also included in the product offering are high temperature tabs and test tabs.

The TE high-temperature tab is designed to crimp to heating element wire. The tab end protrudes through a ceramic/high-temperature housing for mating with either a standard 250 or 312 FASTON receptacle.

Stock Thickness — .032 [0.81]

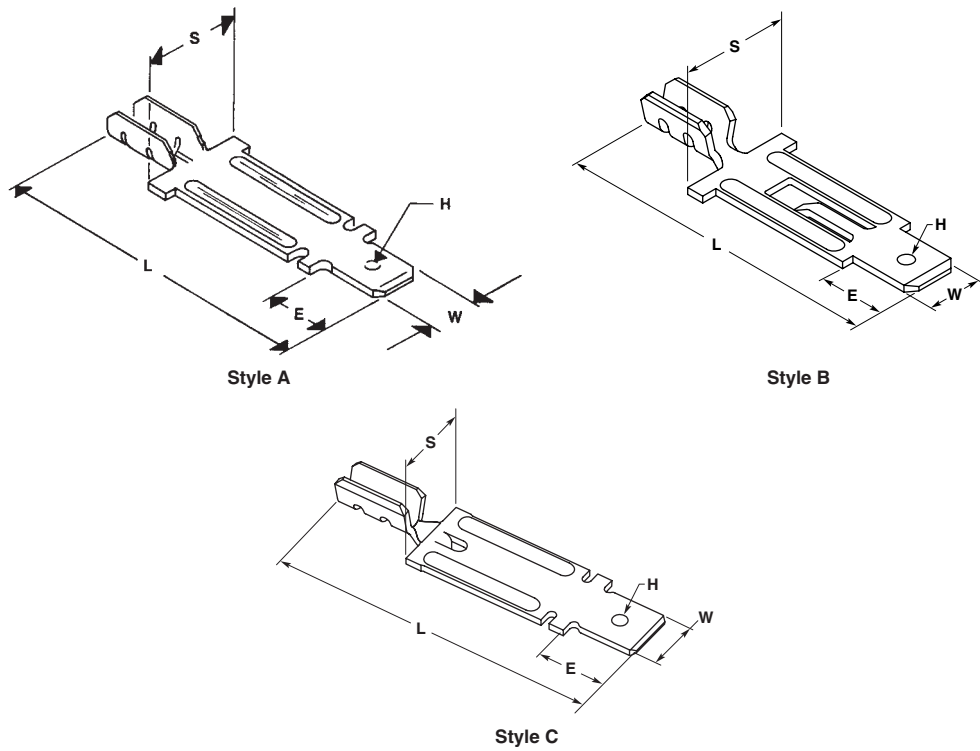

| Series | Solid Wire Range AWG | Style | Tab Thickness | Dimensions | | | | | Material and Finish | Terminal Part No. ¹ |
|--------|----------------------|-------|---------------|----------------|--------------|--------------|---------------|---------------------|---------------------|--------------------------------|
| | | | | L | W | E | S | H | | |
| 312 | 22-15 | A | .032 0.81 | 1.570 39.88 | .312 7.92 | .387 9.83 | .500 12.70 | Hole | Nickel Plated Steel | 63300-1 |
| | | C | .032 0.81 | 1.570 39.88 | .312 7.92 | .375 9.53 | Hole | Nickel Plated Steel | 63390-1 | |
| 250 | 22-15 | A | .032 0.81 | 1.500 38.10 | .250 6.35 | .312 7.92 | .500 12.70 | Dimple | Nickel Plated Steel | 63301-1 |
| | | A | .032 0.81 | 1.500 38.10 | .250 6.35 | .312 7.92 | .500 12.70 | Hole | Nickel Plated Steel | 63522-1 |
| 250 | 20-15 | B | .032 0.81 | 1.500 38.10 | .250 6.35 | .312 7.92 | .500 12.70 | Dimple | Nickel Plated Steel | 63104-1 |
| | | C | .032 0.81 | 1.500 38.10 | .250 6.35 | .312 7.92 | .370 9.40 | Dimple | Nickel Plated Steel | 1217006-1 |

¹ Contact technical support for tooling application.

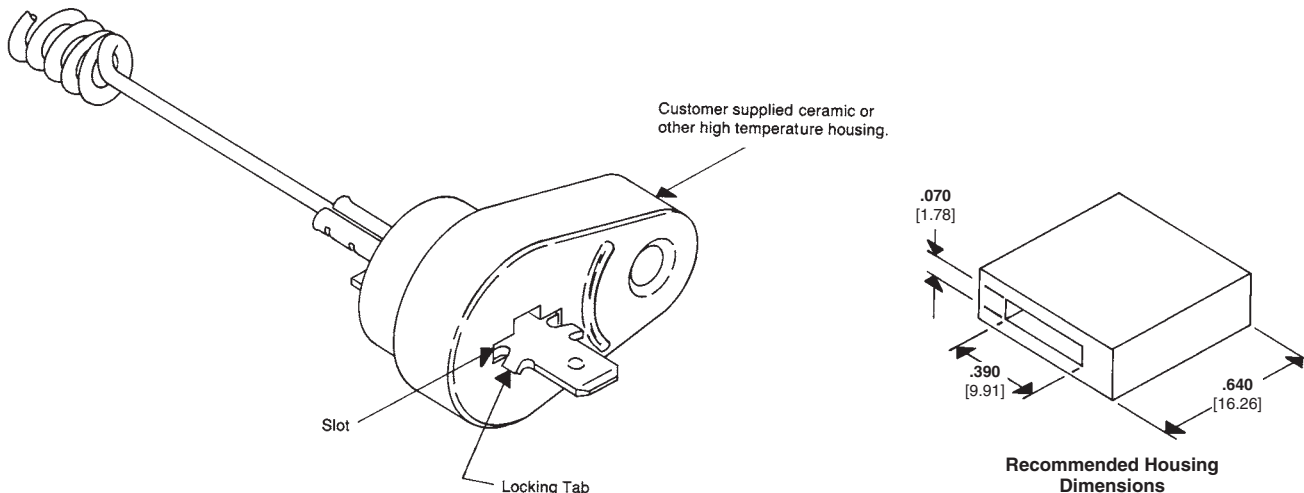

Note: All part numbers are RoHS compliant.

FASTON Tabs (Continued)

250 Series Wire Crimp Tabs

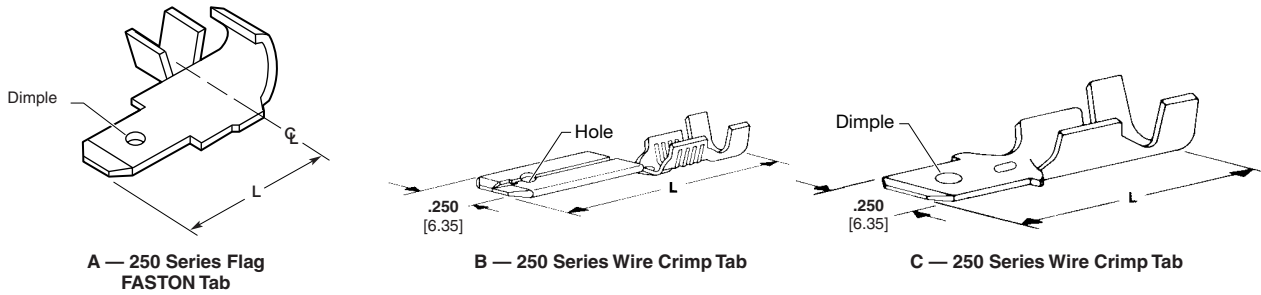

| Wire Range AWG | Style | Tab Thickness | Insulation Diameter | Material and Finish | Stock Thickness | L (Overall Length) | UL | RU | SR | Terminal Part No. |
|-------------------|-------|------------------|------------------------|-------------------------|----------------------|-----------------------|---------------|----|----|----------------------|
| 22-18 | B | .032 0.81 | .080-.120 2.03-3.05 | Brass | .015 0.38 | .815 20.70 | — | X | X | 42475-3 |
| | | .032 0.81 | .080-.120 2.03-3.05 | Brass, Tin Plated | .015 0.38 | .815 20.70 | — | X | X | 42475-4 |
| 18-14 | A | .032 0.81 | .080-.125 2.03-3.18 | Brass, Tin Plated | .032 0.81 | .500 12.70 | X | — | X | 42770-2 |
| | B | .032 0.81 | .110-.150 2.79-3.81 | Brass | .015 0.38 | .810 20.57 | — | X | X | 42474-3 |
| | | .032 0.81 | .110-.150 2.79-3.81 | Brass, Tin Plated | .015 0.38 | .810 20.57 | — | X | X | 42474-4 |
| | C | .032 0.81 | .120-.170 3.05-4.32 | Brass | .032 0.81 | .775 19.69 | X | — | X | 41411 |
| | | .032 0.81 | .120-.170 3.05-4.32 | Brass, Tin Plated | .032 0.81 | .775 19.69 | X | — | X | 41412 |
| | 14-12 | B | .032 0.81 | .110-.170 2.79-4.32 | Brass, Tin Plated | .015 0.38 | .810 20.57 | — | X | X |
| .032 0.81 | | | .110-.170 2.79-4.32 | Brass, Silver Plated | .015 0.38 | .810 20.57 | — | X | X | 61362-2 |

¹ Hole.

205 Series Wire Crimp Tabs

Stock Thickness — .020 [0.51]

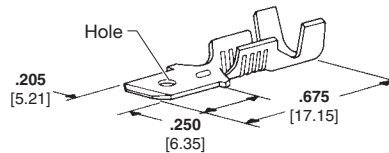

A — 205 Series Wire Crimp Tab

| Wire Range AWG | Style | Tab Thickness | Insulation Diameter | Material and Finish | UL | RU | SR | Terminal Part No. |
|-------------------|-------|------------------|------------------------|------------------------|----|----|----|----------------------|
| 18-14 | A | .020 0.51 | .120-.150 3.05-3.81 | Brass, Tin Plated | X | — | X | 62531-1 |
| | | .020 0.51 | .120-.150 3.05-3.81 | Brass, Tin Plated | X | — | X | 63223-1 ¹ |

¹ No hole.

Note: All part numbers are RoHS compliant.

FASTON Tabs (Continued)

187 Series Wire Crimp Tabs

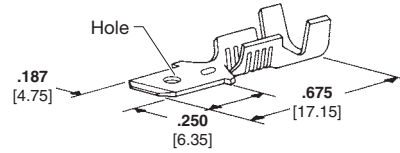

A — 187 Series Wire Crimp Tab

| Wire Range AWG | Style | Tab Thickness | Insulation Diameter | Material and Finish | Stock Thickness | UL | RU | SR | Terminal Part No. |
|-------------------|-------|------------------|------------------------|------------------------|--------------------|----|----|----|----------------------|
| 22-18 | A | .020 0.51 | .080-.120 2.03-3.05 | Brass, Tin Plated | .020 0.51 | X | — | X | 42490-3 |
| | | .020 0.51 | .080-.120 2.03-3.05 | Brass | .020 0.51 | X | — | X | 42490-4 |
| 18-14 | A | .020 0.51 | .120-.150 3.05-3.81 | Brass | .020 0.51 | X | — | X | 60850-1 |
| | | .020 0.51 | .120-.150 3.05-3.81 | Brass, Tin Plated | .020 0.51 | X | — | X | 60850-2 |
| | | .032 0.81 | .120-.150 3.05-3.81 | Brass, Tin Plated | .032 0.81 | X | — | X | 61687-2 ¹ |

¹ Premilled dual stock thickness, tab .032 [0.81], body .020 [0.51].

110 Series Wire Crimp Tabs

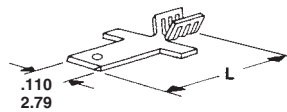

A — 110 Series Wire Crimp Tab

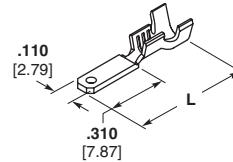

B — 110 Series Wire Crimp Tab with Insulation Support

| Wire Range AWG | Style | Tab Thickness | Insulation Diameter | Material and Finish | Stock Thickness | L (Overall Length) | UL | RU | SR | Terminal Part No. |
|-------------------|-------|------------------|------------------------|----------------------------------|--------------------|-----------------------|----|----|----|------------------------|
| 26-22 | A | .020 0.51 | — | Brass, Tin Plated | .020 0.51 | .490 12.45 | X | — | X | 62887-1 |
| | | .020 0.51 | — | Brass, Tin Plated over Copper | .020 0.51 | .490 12.45 | X | — | X | 62887-2 |
| 22-18 | B | .032 0.81 | — | Brass, Tin Plated | .020 0.51 | .490 12.45 | X | — | X | 63932-1 ² |
| | | .020 0.51 | — | Brass, Pre-Tin Plated | .020 0.51 | .485 12.32 | X | — | X | 62122-1 |
| | A | .020 0.51 | — | Brass, Pre-Tin Plated | .020 0.51 | .570 14.48 | X | — | X | 62384-1 |
| | | .032 0.81 | .070-.130 1.78-3.30 | Brass, Tin Plated | .032 0.81 | .625 15.88 | X | — | X | 63138-1 |
| 20-16 | A | .020 0.51 | — | Brass, Pre-Tin Plated | .020 0.51 | .570 14.48 | — | — | — | 1217118-1 ¹ |

¹ .052 [1.32] dia. hole.
² No insulation support.

.060 Series Wire Crimp Tabs

Stock Thickness — .032 [0.81]

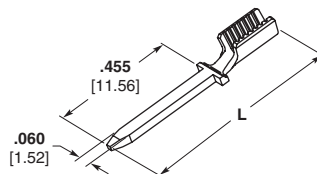

A - .060 Series Wire Crimp Tab

| Wire Range AWG | Style | Tab Thickness | Insulation Diameter | Material and Finish | L (Overall Length) | UL | RU | SR | Terminal Part No. |
|-------------------|-------|------------------|------------------------|------------------------|-----------------------|----|----|----|----------------------|
| 23-19 | A | .032 0.81 | — | Brass, Tin Plated | .740 18.80 | X | — | X | 63497-1 ¹ |
| 22-16 | A | .032 0.81 | — | Brass, Tin Plated | .740 18.80 | X | — | X | 63893-1 |

¹ AMPLIVAR connector type serrations for magnet wire.

Note: All part numbers are RoHS compliant.

FASTON Tabs (Continued)

AMPLIVAR Tabs
(For Use with Magnet Wire)

187 Series FASTON Tabs

Board Thickness —
A = .062-.072 [1.57-1.83]

Stock Thickness —
A = .020 [0.51]
B = .032 [0.81]



| Style | Wire Range | | Material | Dim. L | UL | SP | Part Number |
|-------|------------|-----------------|------------------|----------------|----|----|-------------|
| | AWG | mm ² | | | | | |
| A | 22-16 | 0.3-1.4 | Tin Plated Brass | 1.015 25.78 | — | — | 62447-1 |
| | 15-12 | 1.6-3.0 | Tin Plated Brass | 1.015 25.78 | — | — | 62445-1 |

250 Series FASTON Tabs

Stock Thickness — .032 [0.81]



| Style | Wire Range | | Material | UL | SP | Part Number |
|-------|------------|------------------|----------|----|----------------------|-------------|
| | AWG | mm ² | | | | |
| 18-14 | 1.0-1.7 | Tin Plated Brass | — | — | 63349-1 ¹ | |
| 16-12 | 1.3-3.0 | Tin Plated Brass | — | — | 62922-1 ¹ | |

¹ Varnish resistant coating.



| Style | Wire Range | | | Material | Dimensions | | | UL | SP | Part Number |
|-------|------------|---------|-----------------|------------------|---------------|--------------|-----|----|----|-------------|
| | CMA | AWG | mm ² | | L | E | T | | | |
| A | 200-566 | 27.5-23 | — | Tin Plated Brass | .580 14.73 | .342 8.69 | 45° | — | — | 63136-1 |

Note: All part numbers are RoHS compliant.

FASTON Tabs (Continued)

250, 205 and 187 Series FASTON Tabs

(Mates with all 250, 205 and 187 Series FASTON Receptacles)

250 and 187 Series Weld Type Tabs

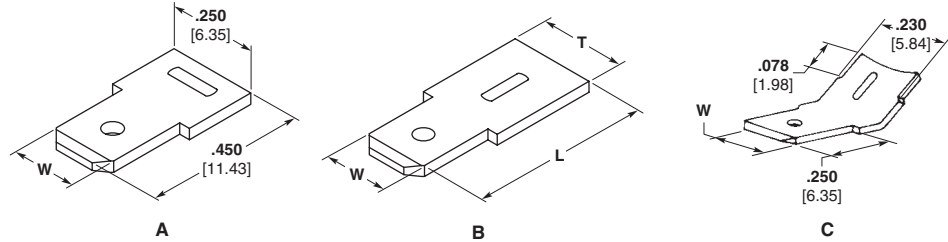

| Style | Dimensions | | | Stock Thickness | Material and Finish | Terminal Part No. | UL | SP |
|-------|--------------|---------------|--------------|-----------------|---------------------|----------------------|----|----|
| | W | L | T | | | | | |
| A | .250 6.35 | .635 16.13 | .295 7.49 | .032 0.81 | Nickel Plated Steel | 42559-1 ¹ | X | X |
| | .187 4.75 | .450 11.43 | .250 6.35 | .032 0.81 | Nickel Plated Steel | 63771-1 | — | — |
| B | .250 6.35 | .825 20.96 | .375 9.53 | .032 0.81 | Nickel Plated Steel | 1217002-1 | — | — |
| C | .187 4.75 | .250 6.35 | .230 5.84 | .020 0.51 | Nickel Plated Steel | 61960-1 | X | X |

¹ No weld rib.

250 Series Stud Mount Type Tabs

Stock Thickness — .032 [0.81]
Dimple (Both Sides)

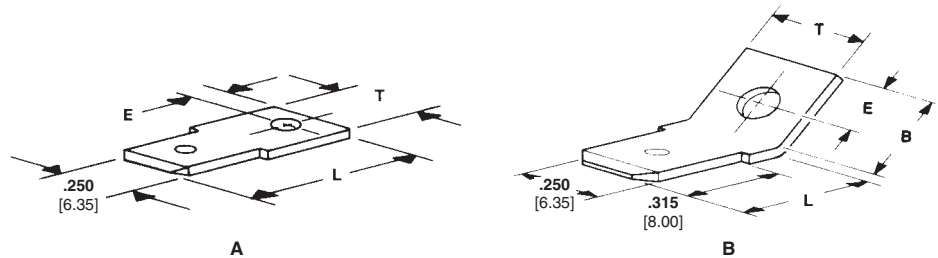

| Style | Stud Diameter | Dimensions | | | | Material and Finish | Terminal Part No. | UL | SP |
|-------|---------------|--------------|---------------|--------------|--------------|---------------------|-------------------|----|----|
| | | B | L | E | T | | | | |
| A | .177 4.50 | — | .715 18.16 | .170 4.32 | .295 7.49 | Brass | 63038-2 | X | — |
| | | | .715 18.16 | .170 4.32 | .295 7.49 | Tin Plated Brass | 63038-1 | X | X |
| | .171 4.34 | — | .940 23.88 | .125 3.18 | .280 7.11 | Brass | 1217558-1 | — | — |
| | | | .940 23.88 | .125 3.18 | .280 7.11 | Tin Plated Brass | 1217558-2 | — | — |
| B | .130 3.30 | .300 7.62 | .400 10.16 | .170 4.32 | .295 7.49 | Tin Plated Brass | 42822-2 | X | X |
| | .145 3.68 | .300 7.62 | .400 10.16 | .170 4.32 | .295 7.49 | Tin Plated Brass | 42822-4 | X | X |
| | .171 4.34 | .330 8.38 | .375 9.53 | .170 4.32 | .295 7.49 | Brass | 60465-1 | X | X |
| | | | | | | Tin Plated Brass | 60465-2 | X | X |
| | .203 5.16 | .330 8.38 | .375 9.53 | .170 4.32 | .295 7.49 | Tin Plated Brass | 61365-1 | X | X |
| | .197 5.00 | .330 8.38 | .375 9.53 | .170 4.32 | .295 7.49 | Tin Plated Brass | 61499-1 | X | X |

Note: All part numbers are RoHS compliant.

FASTON Tabs (Continued)

**250 Series
Stud Mount Type Tabs**

(Continued)

Stock Thickness — .032 [0.81]

Dimple (Both Sides)

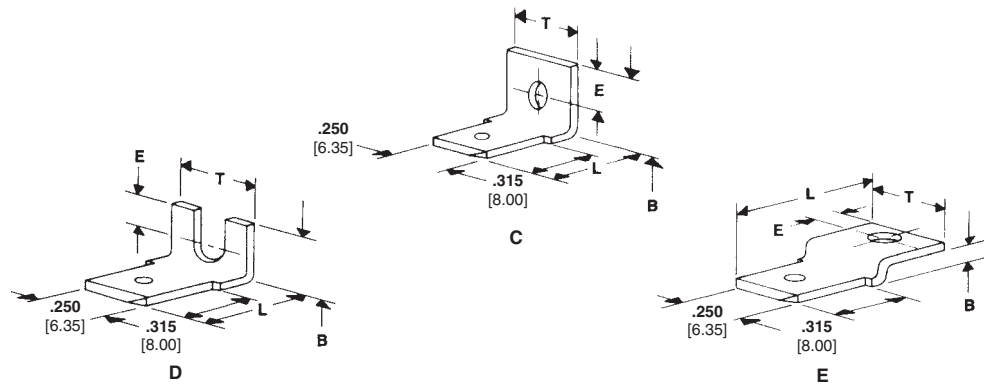

| Style | Stud Diameter | Dimensions | | | | Material and Finish | Terminal Part No. | UL | SP |
|-------|---------------|--------------|---------------|---------------|--------------|---------------------|-------------------|---------|----|
| | | B | L | E | T | | | | |
| C | .097 2.46 | .250 6.35 | .440 11.18 | .093 2.36 | .295 7.49 | Brass | 41339 | X | X |
| | .130 3.30 | .330 8.38 | .440 11.18 | .170 4.32 | .295 7.49 | Tin Plated Brass | 42095-1 | X | X |
| | | .270 6.86 | .440 11.18 | .110 2.79 | .295 7.49 | Tin Plated Brass | 42117-2 | X | X |
| | .171 4.34 | .330 8.38 | .440 11.18 | .170 4.32 | .295 7.49 | Brass | 42214-1 | X | X |
| | | .313 7.95 | .656 16.67 | .125 3.18 | .250 6.35 | Tin Plated Brass | 42214-2 | X | X |
| | | | .472 11.99 | .394 10.00 | — | .295 7.49 | Tin Brass | 62314-2 | X |
| D | .125 3.18 | .235 5.97 | .440 11.18 | .125 3.18 | .295 7.49 | Brass | 41398 | X | X |
| | .171 4.34 | .330 8.38 | .440 11.18 | .120 3.05 | .205 5.20 | Brass | 62166-1 | X | X |
| | | .130 3.30 | .068 1.73 | .615 15.62 | .093 2.36 | .295 7.49 | Tin Plated Brass | 42506-2 | X |

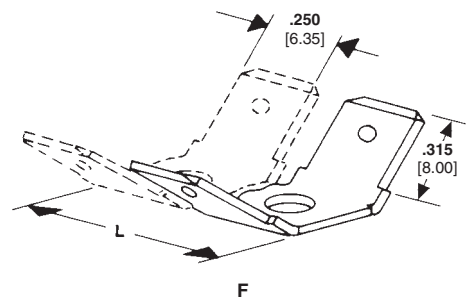

| Style | Pairs | Stud Diameter | Dim. L | Material and Finish | Terminal Part No. | UL | SP |
|-------|-------|---------------|----------------|---------------------|-------------------|----|----|
| F | 2 | .130 3.30 | .690 17.53 | Tin Plated Brass | 41478 | X | X |
| | | .171 4.34 | .690 17.53 | Brass | 41617 | X | X |
| | 4 | .130 3.30 | 1.455 36.96 | Tin Plated Brass | 41484 | X | X |

Note: All part numbers are RoHS compliant.

FASTON Tabs (Continued)

250 Series Stud Mount Type Tabs

(Continued)

Stock Thickness — .032 [0.81]

Dimple (Both Sides)

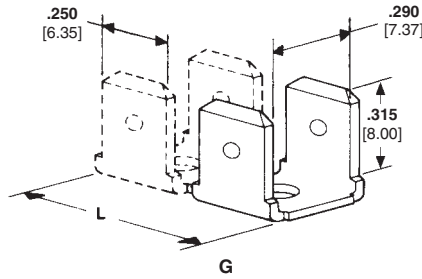

| Style | Pairs | Stud Diameter | Dim. L | Material and Finish | Terminal Part No. | | |
|-------|-------|---------------|----------------|---------------------|----------------------|-------|---|
| G | 1 | .130 3.30 | .315 8.00 | Brass | 41290 | X | X |
| | 2 | .130 3.30 | .690 17.53 | Brass | 41291 | X | X |
| | 3 | .130 3.30 | 1.065 27.05 | Brass | 41292 | X | X |
| | 4 | .130 3.30 | 1.440 36.58 | Brass | 41370 | X | X |
| | 1 | .130 3.30 | .315 8.00 | Tin Plated Brass | 41480 | X | X |
| | 2 | .130 3.30 | .690 17.53 | Tin Plated Brass | 41481 | X | X |
| | 3 | .130 3.30 | 1.065 27.05 | Tin Plated Brass | 41482 | X | X |
| | — | .130 3.30 | — | Tin Plated Brass | 42115-4 ¹ | X | X |
| | | | | Brass | 42115-6 ¹ | X | X |
| | 1 | | .171 4.34 | .315 8.00 | Brass | 41619 | X |
| | | .097 2.46 | .315 8.00 | Tin Plated Brass | 42802-1 | X | X |
| | | | | Tin Plated Brass | 60080-2 | X | X |

¹ In continuous strip-form.

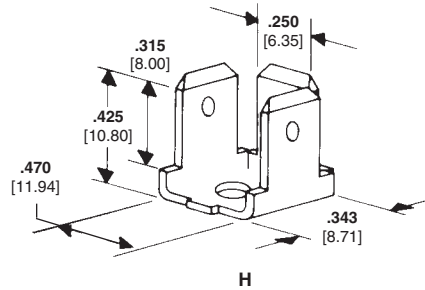

| Style | Stud Diameter | Material and Finish | Terminal Part No. | | |
|-------|---------------|---------------------|-------------------|---|---|
| H | .130 3.30 | Brass | 62261-1 | X | X |

205 Series Stud Mount Type Tabs

Tab Thickness — .032 [0.81]

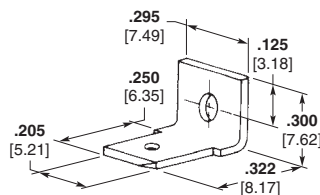

| Stud Diameter | Material and Finish | Terminal Part No. | | |
|---------------|---------------------|-------------------|---|---|
| .145 3.68 | Brass | 62168-1 | X | X |
| .130 3.30 | Brass | 61836-1 | X | X |

Note: All part numbers are RoHS compliant.

FASTON Tabs (Continued)

**187 Series
Stud Mount Type Tabs —
Hole in Tab**

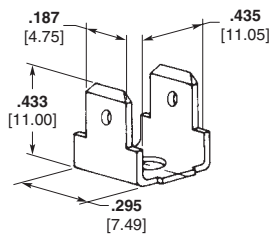

A

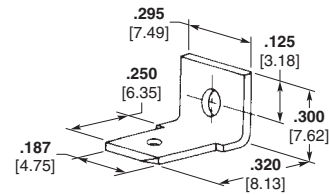

B

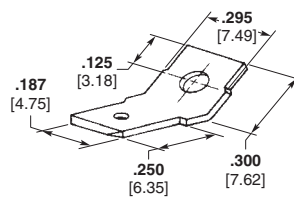

C

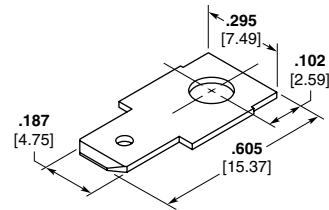

D

| Style | Stud Diameter | Stock Thickness | Material and Finish | Terminal Part No. | UL | CS® |
|-------|---------------|-----------------|---------------------|----------------------|----|-----|
| A | .130 3.30 | .020 0.51 | Tin Plated Brass | 61951-1 | X | X |
| | .197 5.00 | .020 0.51 | Tin Plated Brass | 61914-1 | X | X |
| B | .145 3.68 | .020 0.51 | Tin Plated Brass | 61407-3 | X | X |
| C | .130 3.30 | .020 0.51 | Tin Plated Brass | 61761-2 ² | X | X |
| | .145 3.68 | .020 0.51 | Brass | 62576-1 ² | X | X |
| D | .171 4.34 | .020 0.51 | Tin Plated Brass | 61664-1 ² | X | X |
| | .130 3.30 | .020 0.51 | Tin Plated Brass | 63946-1 | — | — |
| | .145 3.68 | .020 0.51 | Tin Plated Brass | 1742041-1 | — | — |

¹ Weld tab.
² Bent 45°.

Note: All part numbers are RoHS compliant.

FASTON Tabs (Continued)

250 Series Test Tabs
(Mate with all "250" Series FASTON Receptacles)

The mechanical tab is mounted onto TE gauge 100505 for testing of receptacle insertion/extraction requirements. Double-ended test tabs are also available for electrical and temperature rise testing. TE has readily available a variety of UL 310 constructed tabs for mechanical testing of FASTON, Ultra-Fast FASTON and Positive Lock receptacles. These tabs are designed for electrical test setups as outlined in UL 310 (See instruction sheet 408-7432 for recommended procedure mechanical test).

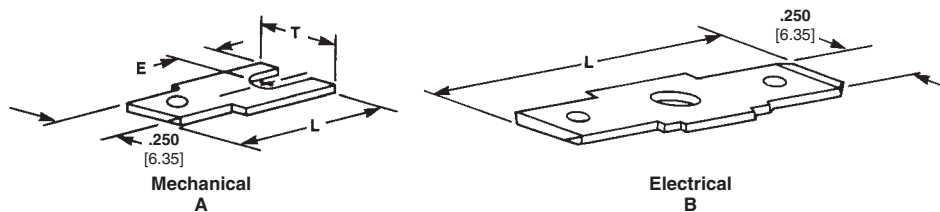

| Style | Stud Diameter | Stock Thickness | Dimensions | | | Material and Finish | UL | CS | Terminal Part No. |
|-------|---------------|-----------------|----------------|--------------|--------------|---------------------|----|----|------------------------|
| | | | L | E | T | | | | |
| A | .125 3.18 | .032 0.81 | .625 15.88 | .125 3.18 | .295 7.49 | Brass | X | X | 60447-1 ^{1,3} |
| | | .020 0.51 | .635 16.13 | .125 3.18 | .295 7.49 | Brass | — | — | 63633-1 ² |
| | | .032 0.81 | .625 15.88 | .125 3.18 | .295 7.49 | Brass | — | — | 63274-1 ² |
| B | .145 3.68 | .032 0.81 | 1.010 25.65 | — | — | Tin Plated Steel | — | — | 62627-1 ³ |
| | | | | | | Brass | — | — | 62627-2 ³ |
| | | | | | | Brass | — | — | 62627-3 ² |

¹ Mechanical test tab for use with TE gauge number 100505.

² Test tab with hole for Positive Lock.

³ Dimple.

FASTON Tabs

205 Series Test Tabs

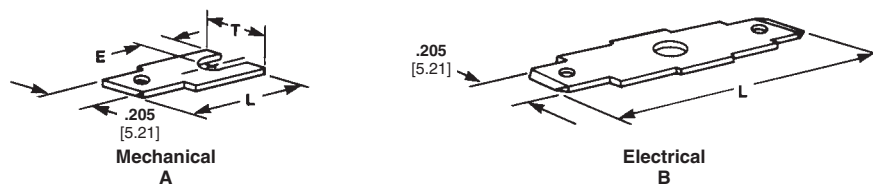

| Style | Hole Diameter | Stock Thickness | Dimensions | | | Material and Finish | UL | CS | Terminal Part No. | |
|-------|---------------|-----------------|------------|----------------|--------------|---------------------|------------------|----|-------------------|----------------------|
| | | | B | L | E | | | | | T |
| A | .125 3.18 | .020 0.51 | — | .605 15.37 | .090 2.29 | .295 7.49 | Brass | X | X | 60613-1 ¹ |
| | | .032 0.81 | — | .605 15.37 | .090 2.29 | .295 7.49 | Brass | X | X | 60613-2 ¹ |
| B | .145 3.68 | .020 0.51 | — | 1.276 32.41 | — | — | Tin Plated Steel | — | — | 60921-4 |
| | | .032 0.81 | — | 1.276 32.41 | — | — | Brass | — | — | 60922-1 |
| | | .020 0.51 | — | 1.276 32.41 | — | — | Brass | — | — | 60921-1 |
| | | .032 0.81 | — | 1.276 32.41 | — | — | Tin Plated Steel | — | — | 60922-5 |

¹ Mechanical test tab for use with TE gauge number 100505.

Note: All part numbers are RoHS compliant.

FASTON Tabs (Continued)

187 Series Test Tabs
(Mates with all "187" Series Receptacles)

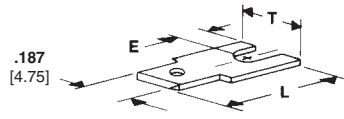

Mechanical
A

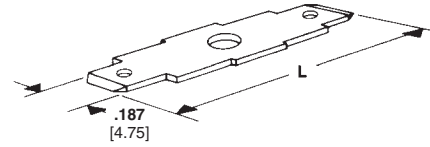

Electrical
B

| Style | Pairs | Stud Diameter | Stock Thickness | Dimensions | | | Material and Finish | UL | SP | Terminal Part No. | |
|-------|-------|---------------|-----------------|------------|-------|------|---------------------|------------------|----|----------------------|----------------------|
| | | | | L | E | T | | | | | |
| A | — | .125 3.18 | .020 | .605 | .090 | .295 | Brass | X | X | 60443-1 ¹ | |
| | | | 0.51 | 15.37 | 2.29 | 7.49 | Tin Plated Brass | — | — | 60443-5 ¹ | |
| | | | .032 | 0.81 | 15.37 | 2.29 | 7.49 | Brass | — | — | 63248-1 ¹ |
| | | | | | | | | Brass | X | X | 60443-2 ¹ |
| | | | | | | | | Tin Plated Brass | X | X | 60443-6 |
| | | | | | | | | Brass | — | — | 63248-2 |
| B | 1 | .145 3.68 | .020 | 1.276 | — | — | Tin Plated Steel | X | X | 60920-4 | |
| | | | 0.51 | 32.41 | — | — | Tin Plated Brass | — | — | 60920-5 | |
| | | | .032 | 0.81 | 32.41 | — | — | Brass | X | X | 62298-1 |
| | | | | | | | | Tin Plated Steel | X | X | 62298-2 |

¹ Test tab with hole.

125 Series Test Tabs
(Mates with all "125" Series Receptacles)

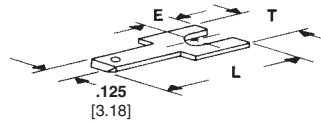

Mechanical
A

| Style | Pairs | Stud Diameter | Stock Thickness | Dimensions | | | Material and Finish | UL | SP | Terminal Part No. |
|-------|-------|---------------|-----------------|---------------|--------------|--------------|---------------------|----|----|-------------------|
| | | | | L | E | T | | | | |
| A | — | .125 3.18 | .020 0.51 | .570 14.48 | .090 2.29 | .295 7.49 | Brass | — | — | 63747-1 |

110 Series Test Tabs
(Mates with all "110" Series Receptacles)

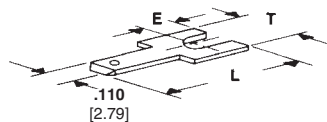

Mechanical
A

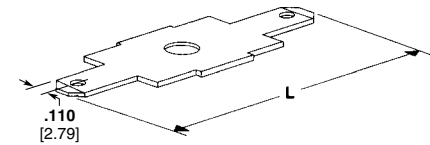

Electrical
B

| Style | Stud Diameter | Stock Thickness | Dimensions | | | Material and Finish | UL | SP | Terminal Part No. | | |
|-------|---------------|-----------------|--------------|-------|-------|---------------------|------------------|-------|-------------------|---------|---------|
| | | | L | E | T | | | | | | |
| A | .125 3.18 | .020 | .570 | .090 | .295 | Brass | X | X | 62061-1 | | |
| | | 0.51 | 14.48 | 2.29 | 7.49 | Brass | — | — | 62061-2 | | |
| | | .032 | .570 | .090 | .295 | | | | | | |
| | | 0.81 | 14.48 | 2.29 | 7.49 | | | | | | |
| | | B | .145 3.68 | .016 | .570 | .090 | .295 | Brass | — | — | 62061-3 |
| | | | | 0.41 | 14.48 | 2.29 | 7.49 | | | | |
| .020 | 0.51 | | | 29.24 | — | — | Tin Plated Steel | X | X | 62628-1 | |
| | | | | | | | .020 | 0.51 | 29.24 | — | — |

Note: All part numbers are RoHS compliant.

FASTON Tab Adapters

250 Series

Fits Tab — .032 [0.81]

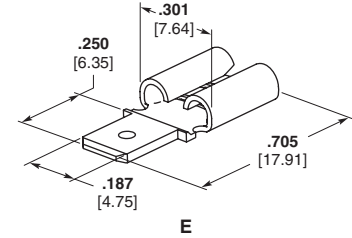
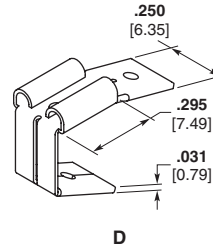
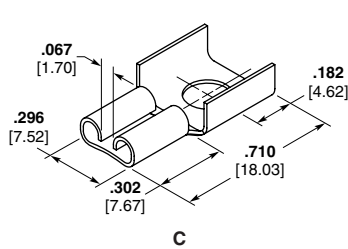
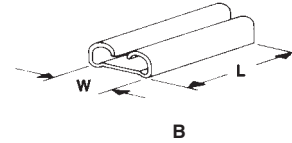
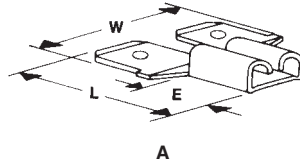

| Style | Stock Thickness | Dimensions | | | Material and Finish | UL | SP | Terminal Part No. |
|-------|---------------------|---------------|---------------|--------------|---------------------|----|----|------------------------|
| | | W | L | E | | | | |
| A | .018 0.46 Recpt. | .650 16.51 | .770 19.56 | .305 7.75 | Brass | X | X | 61765-1 |
| | .032 0.81 Tabs | | | | Tin Plated Brass | X | X | 61765-2 ¹ |
| B | .018 0.46 | .300 7.62 | .700 11.78 | — | Tin Plated Brass | X | X | 61810-2 |
| | | | | | | X | X | 63918-1 ² |
| C | .016 0.41 | — | — | — | Nickel Plated Steel | — | — | 151302-2 |
| | .016 0.41 | — | — | — | Brass (90°) | — | — | 152422-1 |
| D | .016 Recpt. 0.41 | — | — | — | Brass | — | — | 726308-1 |
| | .032 Tabs 0.81 | | | | | | | |
| E | .018 Recpt. 0.46 | .301 7.65 | .705 17.91 | .305 7.75 | Brass | X | X | 1742597-1 ³ |
| | .032 Tabs 0.81 | | | | | | | |

¹ No tab stop on receptacle.

² Fits .025 [0.64] thick tab.

³ .187 [4.75] tab — .250 [6.35] receptacle.

187 Series

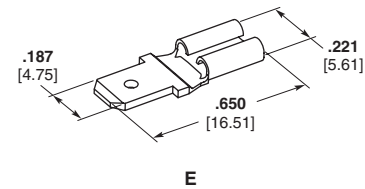
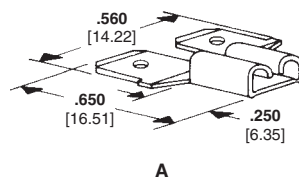

| Style | Stock Thickness | Receptacle Fits Tab | Material and Finish | UL | SP | Terminal Part No. |
|-------|---------------------|---------------------|---------------------|----|----|-------------------|
| A | .013 Recpt. 0.33 | .020 0.51 | Tin Plated Brass | X | X | 61045-2 |
| | .020 Tabs 0.51 | | | | | |
| | .013 Recpt. 0.33 | .032 0.81 | Tin Plated Brass | X | X | 63699-1 |
| | .032 Tabs 0.81 | | | | | |
| E | .013 Recpt. 0.33 | .032 0.81 | Tin Plated Brass | X | X | 1217933-1 |
| | .032 Tabs 0.81 | | | | | |

Note: All part numbers are RoHS compliant.