

C&K Lumotast® 75 Series Illuminated Momentary & Latching Pushbutton Switches



Models Available

Features/Benefits

- Momentary and latching styles
- Illuminated
- Position visibly indicated
- IP40 Degree of protection

Typical Applications

- Machine process control
- Banking equipment
- Medical equipment



Pushbutton

How To Order

To order, select switch/housing, lens, illumination and diffuser part numbers. Accessories, filament lamps and LEDs available separately, see catalog section L. Other functions, contact arrangements, lens colors, flush models and sealed versions available, consult Customer Service Center.

Specifications

CONTACT RATING: 4 AMPS @ 12 - 250 V AC. 0.2 AMPS @ 12 - 220 V DC.
 CONTACT SYSTEM: Snap-action bridge contact.
 CONTACT ARRANGEMENT: 2 NO + 2 NC (μ contact: cannot be used for main voltage).
 CONTACT RESISTANCE: ≤ 200 milliohms after operating life.
 BOUNCE TIME: < 10 ms.
 ILLUMINATION: Filament lamp T 4.5 or LED.
 FIXING: With threaded ring.
 OPERATING LIFE: 60,000 cycles min. @ 4 AMPS @ 250 V AC.
 SWITCHING TRAVEL: NO on: 1.6 mm. NC on: 0.9 mm.
 OPERATING FORCE: 3 to 6.5 N max.
 OPERATING TEMPERATURE: Without lamp/LED: - 25° C to + 70° C; - 13° F to + 158° F. With lamp/LED: - 25° C to + 55° C; - 13° F to + 131° F.

FULL TRAVEL: 2.7 mm.
 DEGREE OF PROTECTION: IP40; > 1mm ø, voltage protection against contact with wires. (IP65; Dust-proof, water splash and dew condensation, also available, consult Customer Service Center).
 APPROVALS: UL/CSA/VDE and others, consult Customer Service Center).

Materials

SWITCH HOUSING WITH COLLAR: PA 6, black.
 CONTACT HOUSING: Thermosetting plastic.
 LENS: PC.
 CONTACT MATERIAL: Ag (Au available, consult factory).
 TERMINALS: Solder terminals, tin-plated.
 FLAMMABILITY OF PLASTIC MATERIALS: UL 94 V0.

16.2 mm Mounting Hole Diameter Round Models with Protruding Lens

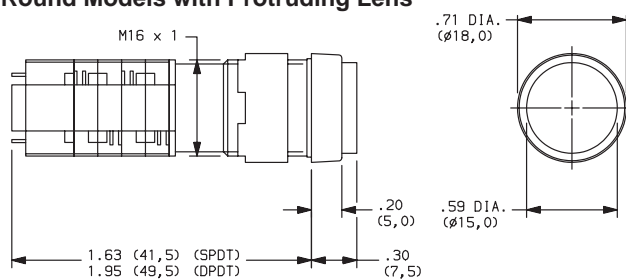

PANEL MOUNTING

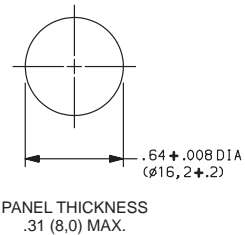

1.15108.4510000
 5.49257.0111002
 5.72050.0000202
 1.90100.0210000
1 N.C. + 1 N.O.

SWITCH & HOUSING			TRANSPARENT LENS		WHITE DIFFUSER		ILLUMINATION	
PART NUMBER	FUNCTION	SCHEMATIC	PART NUMBER	COLOR	PART NUMBER	STYLE	PART NUMBER	FILAMENT LAMP
1.15108.4510000	1 NC + 1 NO Momentary		5.49257.0111002 5.49257.0111303 5.49257.0111402 5.49257.0111502 5.49257.0111601	Colorless Red Yellow Green Blue	5.72050.0000202	Round	1.90100.0210000 1.90100.0220000 1.90100.0230000	6 V 12 V 24 V
1.15108.5510000	1 NC + 1 NO Latching							
1.15108.4520000	2 NC + 2 NO Momentary							
1.15108.5520000	2 NC + 2 NO Latching							

NOTE: Schematics shown represent momentary models only.



Cannon

C&K Lumotast[®] 75 Series Illuminated Momentary & Latching Pushbutton Switches

16.2 mm Mounting Hole Diameter
Square Models with Flush Lens



Pushbutton



1.15108.2510000
5.49275.0361002
5.73013.0000202
1.90100.0210000
1 N.C. + 1 N.O.

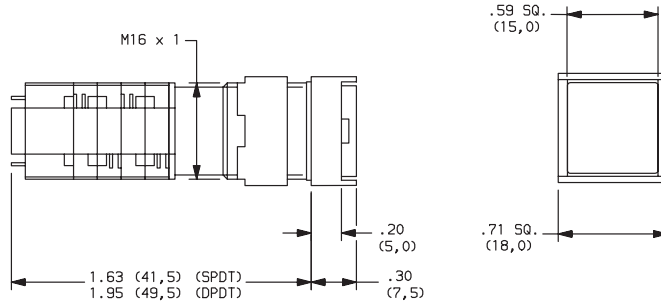

PANEL MOUNTING

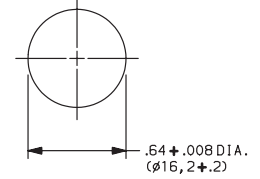

PANEL THICKNESS
.31 (8,0) MAX.

SWITCH & HOUSING			TRANSPARENT LENS		WHITE DIFFUSER		ILLUMINATION	
PART NUMBER	FUNCTION	SCHEMATIC	PART NUMBER	COLOR	PART NUMBER	STYLE	PART NUMBER	FILAMENT LAMP
1.15108.2510000	1 NC + 1 NO Momentary		5.49275.0361002 5.49275.0361303 5.49275.0361402 5.49275.0361502 5.49275.0361601	Colorless Red Yellow Green Blue	5.73013.0000202	Square	1.90100.0210000 1.90100.0220000 1.90100.0230000	6 V 12 V 24 V
1.15108.3510000	1 NC + 1 NO Latching							
1.15108.2520000	2 NC + 2 NO Momentary							
1.15108.3520000	2 NC + 2 NO Latching							

NOTE: Schematics shown represent momentary models only.

16.2 mm Mounting Hole Diameter
Square Models with Protruding Lens



1.15108.2500000
5.49275.0361002
5.73013.0000202
1.90100.0210000
1 N.C. + 1 N.O.

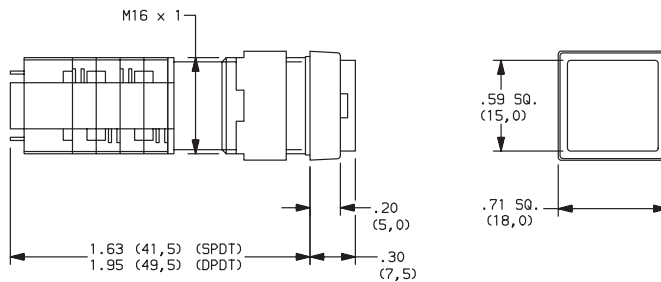

PANEL MOUNTING

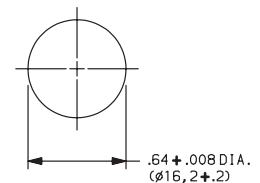

PANEL THICKNESS
.31 (8,0) MAX.

SWITCH & HOUSING			TRANSPARENT LENS		WHITE DIFFUSER		ILLUMINATION	
PART NUMBER	FUNCTION	SCHEMATIC	PART NUMBER	COLOR	PART NUMBER	STYLE	PART NUMBER	FILAMENT LAMP
1.15108.2560000	1 NC + 1 NO Momentary		5.49275.0361002 5.49275.0361303 5.49275.0361402 5.49275.0361502 5.49275.0361601	Colorless Red Yellow Green Blue	5.73013.0000202	Square	1.90100.0210000 1.90100.0220000 1.90100.0230000	6 V 12 V 24 V
1.15108.3560000	1 NC + 1 NO Latching							
1.15108.2570000	2 NC + 2 NO Momentary							
1.15108.3570000	2 NC + 2 NO Latching							

NOTE: Schematics shown represent momentary models only.

C&K Lumotast® 75 Series Illuminated Momentary & Latching Pushbutton Switches

16.2 mm Mounting Hole Diameter
Rectangular Models with Flush Lens

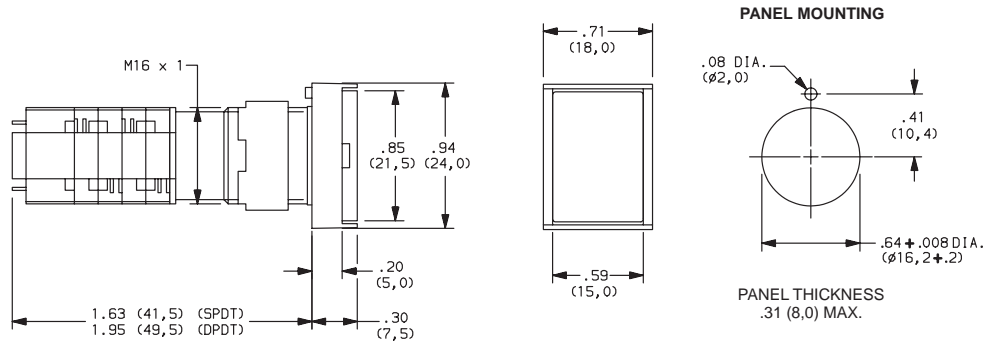

1.15108.0510000
 5.49275.0321002
 5.73012.0000202
 1.90100.0210000
1 N.C. + 1 N.O.

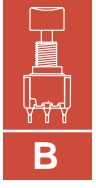

SWITCH & HOUSING			TRANSPARENT LENS		WHITE DIFFUSER		ILLUMINATION	
PART NUMBER	FUNCTION	SCHEMATIC	PART NUMBER	COLOR	PART NUMBER	STYLE	PART NUMBER	FILAMENT LAMP
1.15108.0510000	1 NC + 1 NO Momentary		5.49275.0321002 5.49275.0321303 5.49275.0321402 5.49275.0321502 5.49275.0321601	Colorless Red Yellow Green Blue	5.73012.0000202	Rectangular	1.90100.0210000 1.90100.0220000 1.90100.0230000	6 V 12 V 24 V
1.15108.1510000	1 NC + 1 NO Latching							
1.15108.0520000	2 NC + 2 NO Momentary							
1.15108.1520000	2 NC + 2 NO Latching							

NOTE: Schematics shown represent momentary models only.

Pushbutton

X-ON Electronics

Largest Supplier of Electrical and Electronic Components

Click to view similar products for [Pushbutton Switches](#) category:

Click to view products by [C&K](#) manufacturer:

Other Similar products are found below :

[LW1L-M1C10V-A](#) [LW2L-A1C20M-GD](#) [LW2L-M1C20M-A](#) [60324L](#) [M7E-HRN2](#) [67021K512](#) [67081K512X](#) [701PB580](#) [719-5504-000](#)
[MDPSSGLFS](#) [810KSV30B](#) [FLT 2U EE 01A](#) [MML21KA3ABK](#) [MML23KA3AC05K-001](#) [MML23KW3AA01W](#) [8418K2](#) [8646AB6X718UL](#)
[8646ABUL](#) [FSDWH](#) [9001KXRK](#) [9001T8BK](#) [9533CD4+U574+U4922](#) [1203MRA](#) [A22EM01S](#) [A595](#) [1202A6](#) [12037A2ULCSA](#) [1203A2UL](#)
[ABD122N-B](#) [1211390004](#) [ABN111-Y](#) [ABN400-R](#) [1211500044](#) [1211580012](#) [1212MRA](#) [1232A6NF](#) [RA3CSH6A](#) [1241.1183.7047](#)
[1241.2511](#) [1241.3428](#) [1223A2ULCSA](#) [1223MRA](#) [1232AX2119](#) [1241.1183.8000](#) [1241.1183.8029](#) [1241.2506](#) [1241.2606](#) [12MA6](#)
[1301940184](#) [RELBARF6X10\(PLASTIC\)](#)