

R13-508

Screw Type

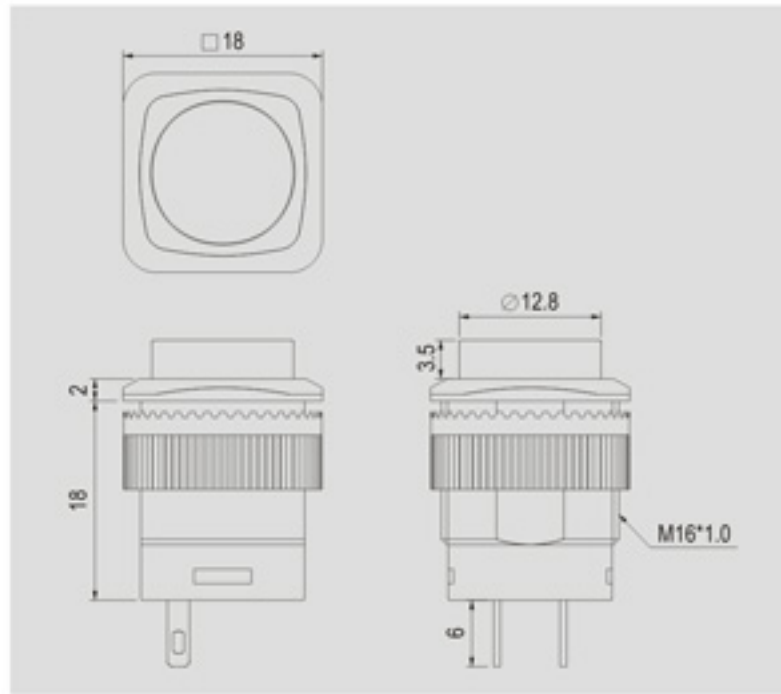

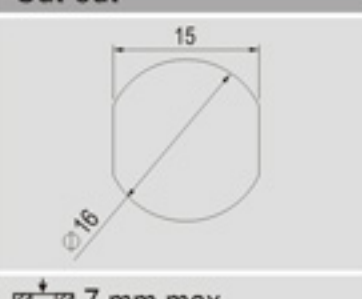



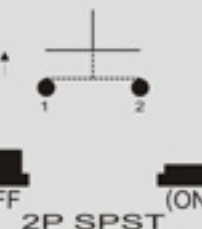

Rating	3A 125V AC 1.5A 250V AC
Contact resistance	50mΩ Max
Insulation resistance	DC 500V 100MΩ Min
Dielectric strength	AC 1500V 1 minute
Cut-out	

FEATURES

- * MATERIAL: Frames are nylon with glass fiber (UL flame: 94V-2). Terminals are silver plated brass.
- * Illuminated actuator are molded in PC, available with red, amber and green colors.
- * Mounted by nut.

R13-508 -

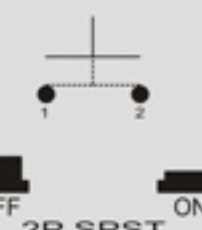
FUNCTION	BUTTON	TERMINAL
A  OFF 2P SPST (ON)	 W/O LED  With LED (3VDC)	 0  5  SO
B  OFF 2P SPST ON		

* () =momentary

X-ON Electronics

Largest Supplier of Electrical and Electronic Components

Click to view similar products for [Pushbutton Switches](#) category:

Click to view products by [SCI manufacturer](#):

Other Similar products are found below :

[LW1L-M1C10V-A](#) [LW2L-A1C20M-GD](#) [LW2L-M1C20M-A](#) [60324L](#) [M7E-HRN2](#) [67021K512](#) [67081K512X](#) [701PB580](#) [719-5504-000](#)
[MDPSSGLFS](#) [810KSV30B](#) [MML21KA3ABK](#) [MML23KA3AC05K-001](#) [MML23KW3AA01W](#) [8418K2](#) [8646AB6X718UL](#) [8646ABUL](#)
[FSDWH](#) [9001KXRK](#) [9001T8BK](#) [9533CD4+U574+U4922](#) [1203MRA](#) [A22EM01S](#) [A595](#) [1202A6](#) [12037A2ULCSA](#) [1203A2UL](#) [ABD122N-](#)
[B](#) [1211390004](#) [ABN111-Y](#) [ABN400-R](#) [1211500044](#) [1211580012](#) [1212MRA](#) [1232A6NF](#) [RA3CSH6A](#) [1241.1183.7047](#) [1241.2511](#)
[1241.3428](#) [1223A2ULCSA](#) [1223MRA](#) [1232AX2119](#) [1241.1183.8000](#) [1241.1183.8029](#) [1241.2506](#) [1241.2606](#) [12MA6](#) [1301940184](#)
[RELBARF6X10\(PLASTIC\)](#) [13435AG](#)