

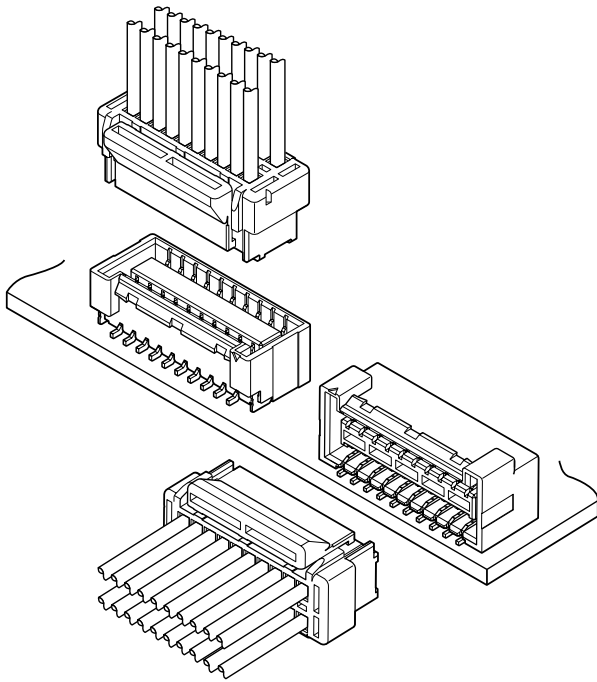

# ZPD CONNECTOR

1.5mm pitch/Disconnectable Crimp style connectors



**In order to correspond to the high-density PC board designing, this ZPD connector is designed as 1.5mm pitch double row type connector with secure locking device. Low insertion force is realized and good mating feeling is also prepared, and these provide the certain mating operation.**

- **Secure locking structure**
- **Low insertion force**
- **Suction area for picking up**
- **Improvement of engagement with prying**

## Specifications

- Current rating: 10 to 30 circuits/ 2 A AC, DC (AWG #24)  
32 to 40 circuits/ 1.5 A AC, DC (AWG #24)
- Voltage rating: 100 V AC, DC
- Temperature range: -25°C to +85°C  
(including temperature rise in applying electrical current)
- Contact resistance: Initial value/ 30 mΩ max.  
After environmental tests/ 60 mΩ max.
- Insulation resistance: 500 MΩ min.
- Withstanding voltage: 500 VAC/minute
- Applicable wire: Conductor size/ AWG #28 to #24  
Insulation O.D./ 0.76 to 1.2 mm

- \* Refer to "General Instruction and Notice when using Terminals and Connectors" at the end of this catalog.
- \* Contact JST for details.
- \* Compliant with RoHS.

## Standards

Recognized E60389

Certified LR20812

## PC board layout and Assembly layout

### Top entry type

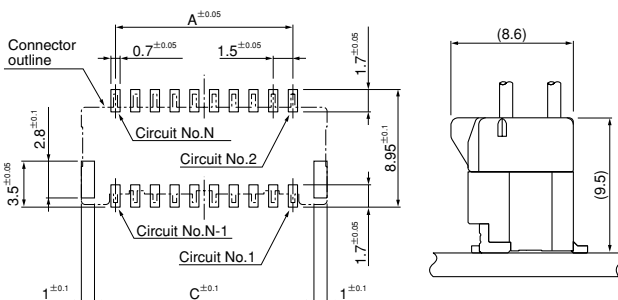

### Side entry type

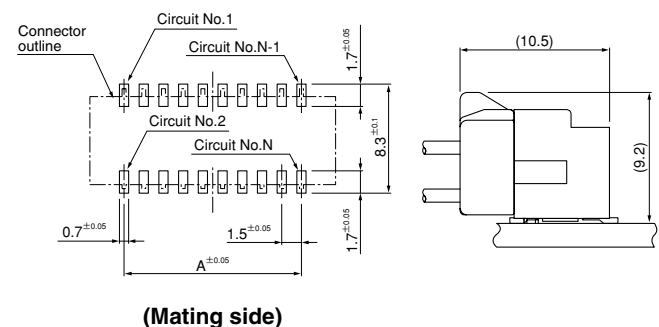

- Note: 1. The above figure is the figure viewed from the connector mounting side.  
2. Tolerances are non-cumulative:  $\pm 0.05$  mm for all centers.  
3. The dimensions above should serve as a guideline. Contact JST for details.

# ZPD CONNECTOR

## Contact

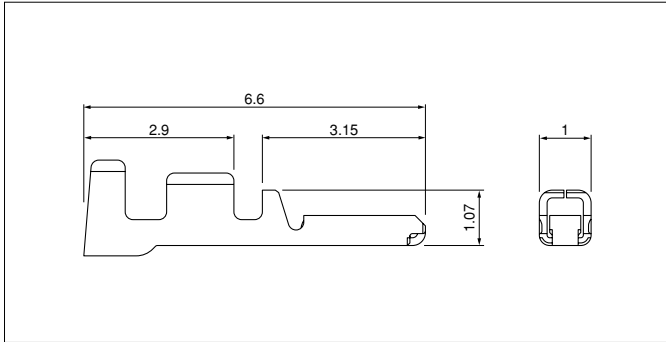

Model No.	Applicable wire		Insulation O.D. (mm)	Q'ty/ reel
	mm <sup>2</sup>	AWG#		
<b>SZPD-002T-P0.3</b>	0.08~0.21	28~24	0.76~1.2	16,000

### Material and Finish

Copper alloy, tin-plated (reflow treatment)

### RoHS compliance

Contact	Crimping machine	Applicator		
		Crimp applicator	Dies	Crimp applicator with dies
<b>SZPD-002T-P0.3</b>	AP-K2N	MKS-L	MK/SZE-002-03	APLMK SZE002-03

## Housing

### <10 circuits>

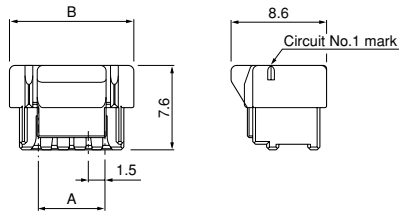

### <12 to 24 circuits>

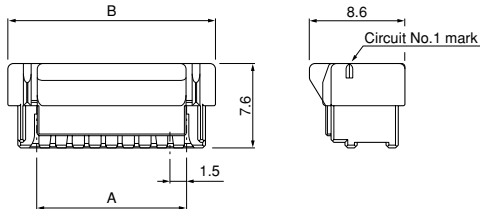

### <26 to 30 circuits>

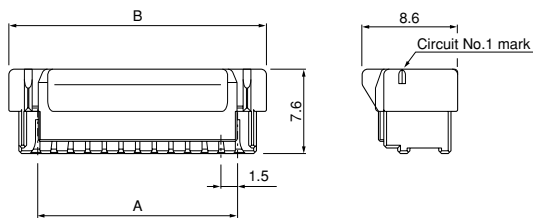

### <32 to 40 circuits>

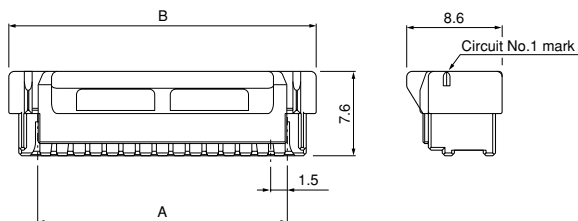

Circuits	Model No.	Dimensions (mm)		Q'ty/ bag
		A	B	
10	<b>ZPDR-10V-S</b>	6.0	11.2	1,000
12	<b>ZPDR-12V-S</b>	7.5	12.7	1,000
14	<b>ZPDR-14V-S</b>	9.0	14.2	1,000
16	<b>ZPDR-16V-S</b>	10.5	15.7	1,000
18	<b>ZPDR-18V-S</b>	12.0	17.2	1,000
20	<b>ZPDR-20V-S</b>	13.5	18.7	1,000
22	<b>ZPDR-22V-S</b>	15.0	20.2	1,000
24	<b>ZPDR-24V-S</b>	16.5	21.7	1,000
26	<b>ZPDR-26V-S</b>	18.0	23.2	1,000
28	<b>ZPDR-28V-S</b>	19.5	24.7	500
30	<b>ZPDR-30V-S</b>	21.0	26.2	500
32	<b>ZPDR-32V-1-Z</b>	22.5	27.7	500
34	<b>ZPDR-34V-1-Z</b>	24.0	29.2	500
36	<b>ZPDR-36V-1-Z</b>	25.5	30.7	500
38	<b>ZPDR-38V-1-Z</b>	27.0	32.2	500
40	<b>ZPDR-40V-1-Z</b>	28.5	33.7	500

### Material

PBT, UL94V-0, natural (10 to 30 circuits), ivory (32 to 40 circuits)

### RoHS compliance

<For reference> As the color identification, the following alphabet shall be put in the underlined part. For availability, delivery and minimum order quantity, contact JST.

ex. **ZPDR-10V-S**

10 to 30 circuits S...natural Z...ivory MG...moss green  
 TR...tomato red DPK...dark pink E...blue  
 32 to 40 circuits Z...ivory K...black

# ZPD CONNECTOR

## Shrouded header

### Top entry type

<10 circuits>

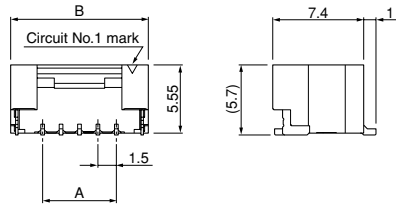

<12 to 30 circuits>

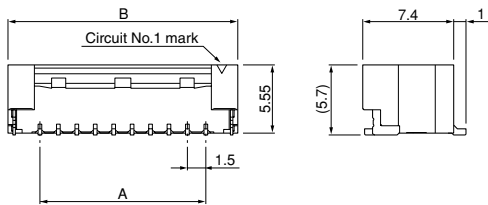

<32 to 40 circuits>

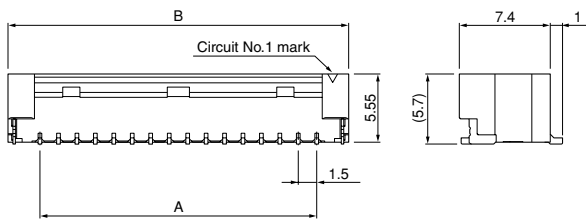

### Side entry type

<10 circuits>

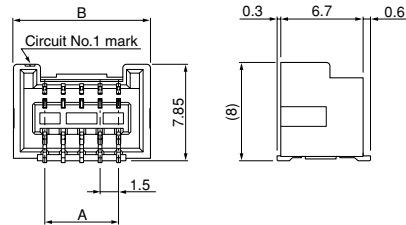

<12 to 30 circuits>

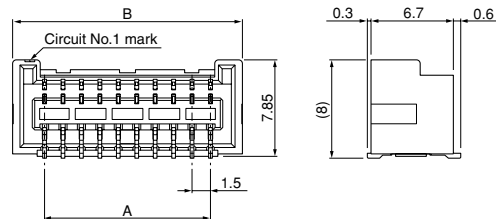

<32 to 40 circuits>

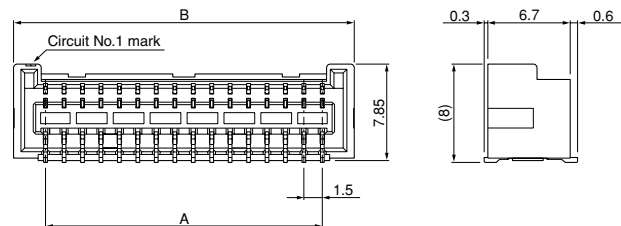

### Top entry type

Circuits	Model No.	Dimensions (mm)			Q'ty/ reel
		A	B	C	
10	BM10B-ZPDSS-TF	6.0	11.2	9.2	1,000
12	BM12B-ZPDSS-TF	7.5	12.7	10.7	1,000
14	BM14B-ZPDSS-TF	9.0	14.2	12.2	1,000
16	BM16B-ZPDSS-TF	10.5	15.7	13.7	1,000
18	BM18B-ZPDSS-TF	12.0	17.2	15.2	1,000
20	BM20B-ZPDSS-TF	13.5	18.7	16.7	1,000
22	BM22B-ZPDSS-TF	15.0	20.2	18.2	1,000
24	BM24B-ZPDSS-TF	16.5	21.7	19.7	1,000
26	BM26B-ZPDSS-TF	18.0	23.2	21.2	1,000
28	BM28B-ZPDSS-TF	19.5	24.7	22.7	1,000
30	BM30B-ZPDZS-TF	21.0	26.2	24.2	1,000
32	BM32B-ZPDZS-TF	22.5	27.7	25.7	1,000
34	BM34B-ZPDZS-TF	24.0	29.2	27.2	1,000
36	BM36B-ZPDZS-TF	25.5	30.7	28.7	1,000
38	BM38B-ZPDZS-TF	27.0	32.2	30.2	1,000
40	BM40B-ZPDZS-TF	28.5	33.7	31.7	1,000

#### Material and Finish

Contact: Copper alloy, copper-undercoated, tin-plated (reflow treatment)  
 Wafer: Polyamide, UL94V-0, natural (10 to 30 circuits)  
 LCP, UL94V-0, ivory (32 to 40 circuits)  
 Reinforcing tab: Copper alloy, copper-undercoated, tin-plated (reflow treatment)

### Side entry type

Circuits	Model No.	Dimensions (mm)		Q'ty/ reel
		A	B	
10	SM10B-ZPDSS-TF	6.0	11.2	700
12	SM12B-ZPDSS-TF	7.5	12.7	700
14	SM14B-ZPDSS-TF	9.0	14.2	700
16	SM16B-ZPDSS-TF	10.5	15.7	700
18	SM18B-ZPDSS-TF	12.0	17.2	700
20	SM20B-ZPDSS-TF	13.5	18.7	700
22	SM22B-ZPDSS-TF	15.0	20.2	700
24	SM24B-ZPDSS-TF	16.5	21.7	700
26	SM26B-ZPDSS-TF	18.0	23.2	700
28	SM28B-ZPDSS-TF	19.5	24.7	700
30	SM30B-ZPDSS-TF	21.0	26.2	700
32	SM32B-ZPDZS-TF	22.5	27.7	700
34	SM34B-ZPDZS-TF	24.0	29.2	700
36	SM36B-ZPDZS-TF	25.5	30.7	700
38	SM38B-ZPDZS-TF	27.0	32.2	700
40	SM40B-ZPDZS-TF	28.5	33.7	700

#### Material and Finish

Contact: Copper alloy, copper-undercoated, tin-plated (reflow treatment)  
 Wafer: Polyamide, UL94V-0, natural (10 to 30 circuits)  
 LCP, UL94V-0, ivory (32 to 40 circuits)

**RoHS compliance** This product displays (LF)(SN) on a label.  
 Note: The products listed above are supplied on embossed-tape.

**RoHS compliance** This product displays (LF)(SN) on a label.  
 Note: The products listed above are supplied on embossed-tape.

<For reference> As the color identification, the following alphabet shall be put in the underlined part.  
 For availability, delivery and minimum order quantity, contact JST.

ex. **BM10B-ZPDSS-TF** **SM10B-ZPDSS-TF**

10 to 30 circuits S...natural Z...ivory MG...moss green TR...tomato red DPK...dark pink E...blue  
 32 to 40 circuits Z...ivory K...black

## X-ON Electronics

Largest Supplier of Electrical and Electronic Components

*Click to view similar products for [Headers & Wire Housings](#) category:*

*Click to view products by [JST](#) manufacturer:*

Other Similar products are found below :

[95000-104TRLF](#) [10135584-644402LF](#) [DF62W-EP2022PCA](#) [95000-106TRLF](#) [DF62W-2022SCA](#) [DF62W-EP2022PC](#) [2203348](#) [DF62W-2022SC](#) [1084018](#) [1029039](#) [1084017](#) [802-10-012-10-002000](#) [1112640](#) [1112639](#) [000-34000](#) [0009482033](#) [0009507031](#) [57102-S06-03LF](#) [57202-S52-04LF](#) [PCN6-15S-2.5E](#) [0039019024](#) [58102-G61-06LF](#) [582553-1](#) [0009485154](#) [0009508121](#) [0022285053](#) [0050291907](#) [018731A](#) [LY20-4P-DT1-P1E-BR](#) [02.125.8002.8](#) [60101931](#) [60598-1 \(Cut Strip\)](#) [M1625-3R/100](#) [61062-3](#) [61082-181009](#) [636-1427](#) [638009-1](#) [641938-9](#) [641991-4](#) [644168-1](#) [647662-1](#) [65039-019ELF](#) [65817-002LF](#) [65817-015LF](#) [65863-015LF](#) [66207-023LF](#) [67016-026LF](#) [67046-001LF](#) [67095-007LF](#) [67230-005LF](#)