

Low cost, high reliability

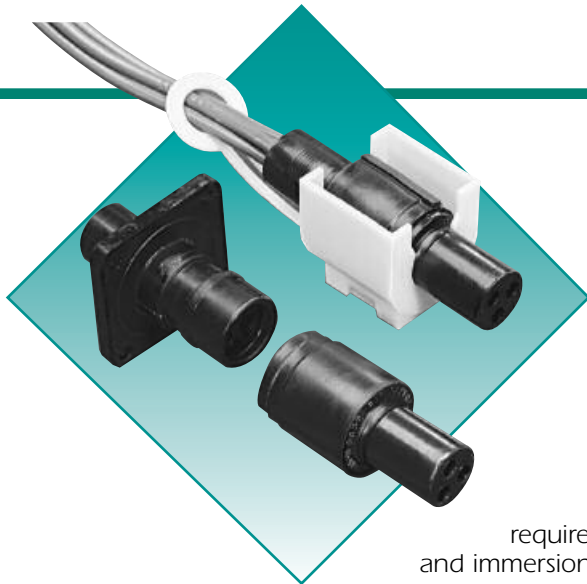

A one-piece resilient body and rugged multiple moisture seals make Sure-Seal® connectors a natural for applications where outside contaminants must be excluded. Sure-Seal® is reliable and uncomplicated. Only two parts are required to complete a connector: the connector body, and the contacts. Sure-Seal® was developed to address Department of Transportation safety regulations for connectors used in automobiles. Since then, Sure-Seal® has been successfully used in a broad range of environmental applications where a small, low cost connector is needed. These sealed connectors meet or exceed DOT requirements for shock, vibration, temperature cycling, salt water spray and immersion, petroleum derivatives, industrial gas, all the while insuring low milli-volt drop and low contact resistance. Existing applications include motorcycles, automobiles, boats, and a wide range of demanding off-road vehicle uses. Sure-Seal® will operate in temperatures from -40°F to +221°F under conditions of high humidity, severe vibration, ice and mud. Sealing integrity is maintained with exposure to brake fluid, gasoline, diesel fuel, anti-freeze, ultraviolet, ozone, and steam.

Applications

Wet, humid, or dirty environments requiring a low cost, small and reliable sealed connector

- Automotive
- Marine
- Appliances
- Trucks and Buses
- Off-road Vehicles
- Industrial Machinery

Features

Low Installed Cost

One piece molded bodies and crimp contacts provide a low cost solution. In addition, these connectors can be easily terminated by the user.

Water Submersible

Not just splash-proof, but truly submersible for short periods of time. Sure-Seal® will seal to the requirements of IP67 and DIN 400 50.

Resistant to Automotive/Industrial Environments

Sure-Seal® will operate in temperatures from -40°F to +221°F under conditions of high humidity, severe vibration, ice and mud. Sealing integrity is maintained with exposure to brake fluid, gasoline, diesel fuel, antifreeze, ultraviolet, ozone, and steam.

Wide Range of Wire Gauges and Current Carrying Capability

Up to 85 amps with wire gauges from size 20 up to size 4 AWG wire.

One-Piece Connector

Sure-Seal® has a simple one-piece molded body. No other parts (other than contacts)

are required. Bodies mate using multiple resilient seals and will remain mated even under severe vibration and shock.

Field Serviceable

The use of removable crimp contacts allows Sure-Seal® connections to be changed or modified in the field if necessary.

Polarized Against Mis-mates

Connector halves use both pin and socket contacts. The plug and receptacle must be properly oriented for the connectors to mate. Raised indexing ribs in conjunction with a stepped plane allow blind mating of the connector halves even in dark or cramped spaces.

Three Sure-Seal® Versions

Sure-Seal® is available in three versions. The basic Sure-Seal® line is the broadest and ideal for most applications. Mini-Sure-Seal® provides a slightly smaller connector in a limited range of configurations. Power Sure-Seal® is for single circuit, high power applications.



NEW! Visit us at: www.suresealconnections.com

Technical Specifications

(Complete test data available on [page 26](#).)



MATERIALS & FINISHES

Body	Elastomeric material (PVC Nitrile standard. Also available in silicone & EPDM)
Contacts	Copper alloy
Plating	Tin standard; gold plating optional

ELECTRICAL DATA

Operating Voltage	400 Vac maximum
Dielectric Withstanding Voltage	1,200 Vac at sea level
Current rating	15 Amps (Sure-Seal®) 8 Amps (Mini Sure-Seal®) 85 Amps (Power Sure-Seal®) Insulator
Wire Range Sizes	14 - 18 AWG (Sure-Seal®) 18 - 20 AWG (Mini Sure-Seal®) 4 - 10 AWG (Power Sure-Seal®)
Contact Resistance	10 Milliohms maximum
Insulation Resistance	100 Megohms (minimum)

MECHANICAL

Operating Temperature	-40°F to +221°F (-40°C to +105°C)
Sealing	≈IP67, DIN 400 50, 3 foot depth in 5% salt solution 24 hours min. ≈NEMA 6 p
Wire Sealing Range	See column 8 on contact chart, page 17
Insulation Strip Lengths	See column 7 on contact chart, page 16
Mating Life	50 cycles minimum (stamped & formed) 100 cycles (machined)
Salt Spray	To MIL-STD-202D Method 101D
Heat	+221°F (+105°C) for 1000 hours (See test data page 26)
Weather, Ozone, & Ultraviolet	In accordance with ASTM D-1149 (100pphm) & ASTM D-1171 (outdoor exposure)
Vibration	5 to 55 Hz .06" DA 1 hour; radial & longitudinal axes
Shock	50g 11ms, 30 cycles; radial & longitudinal axes
Contact Type	Crimp: using hand or semi-automatic tooling
Number of Circuits	1 to 10
Contact Insertion	From rear with simple hand tool or simultaneous insertion of multiple contacts with semi-automatic insertion machine. Removable, 5 cycles minimum
Contact Retention	7.5 lbs. (35N) minimum
Polarization	Stepped plane positive polarization, indexing ribs, and visual polarization all permanently molded into body
Agency Listing	UL (E176866) & CSA (LR109871-1)
Color	Black (alternate colors optional)



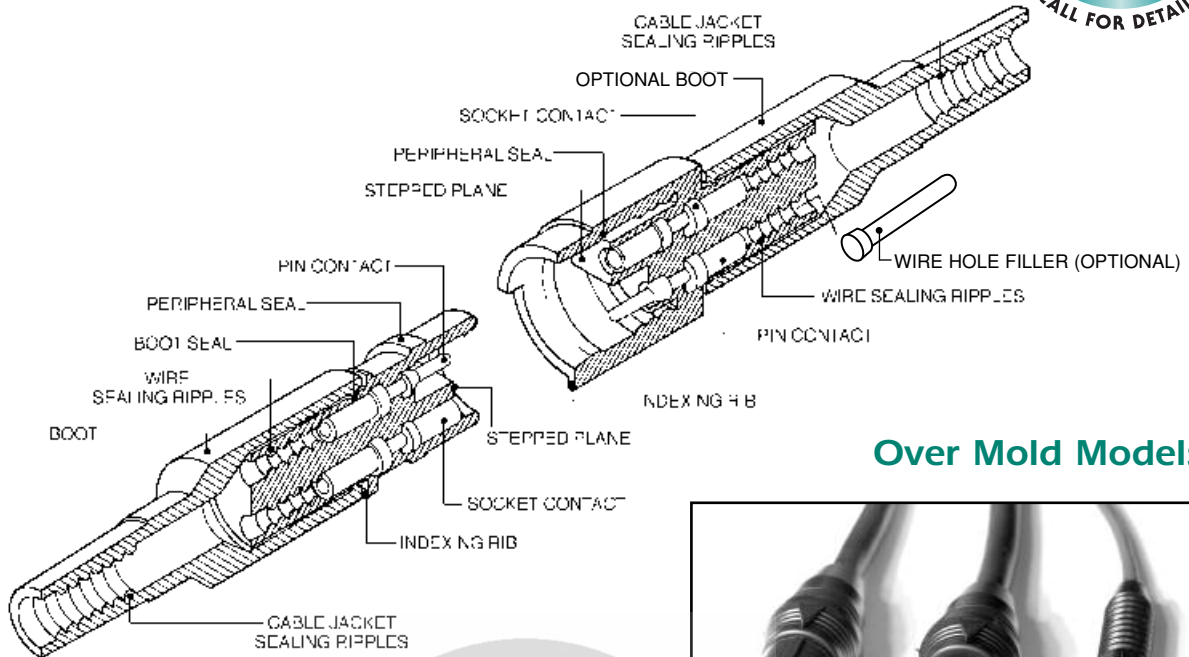

Over Mold Models



How to Select Sure-Seal® Connectors & Accessories

1. Choose series:
(Sure-Seal®, Mini Sure-Seal®, or Power Sure-Seal®).
2. Determine number of circuits required per connector:
 - 1 to 10 in Sure-Seal®
 - 2 to 4 in MINI Sure-Seal®
 - 1 in POWER Sure-Seal®
3. Select connector with appropriate number of circuits.
4. Select Sure-Seal® body style (straight or flanged plug and receptacle).
5. Select connector accessories:
(Boots, Mounting Ring, Mounting Plates, Mounting Clip, Wire Hole Filler, Holding Blocks).

How to Select Sure-Seal® Contacts & Tooling

1. Determine current carrying and wire gauge requirements for application.
2. Select appropriate contacts from contact selection chart on [page 16](#).
3. Choose appropriate crimp, insertion, and extraction tooling on [page 17](#).

Layouts

Notice that all multi-pin Sure-Seal® connectors use a combination of pin and socket contacts in each connector.

View from mating face of receptacle

● pin ○ socket

NEW!

Machined PC Pin Contact. Please Call.

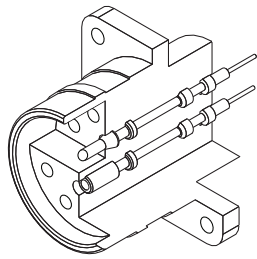

Number of Circuits

AWG Wire Sizes

Connectors



Plug



Flanged Plug



Receptacle

SURE-SEAL®

1	14-18 AWG	120-1832-000	-**	120-1833-000
2	14-18 AWG	120-1807-000	120-8552-200	120-1804-000
3 First-Make/Last-Break Version	14-18 AWG	120-1808-000 120-1808-200	120-8552-201	120-1805-000 120-1805-200
4	14-18 AWG	120-1809-000	120-8552-202	120-1806-000
5	14-18 AWG	120-1841-000	- **	120-1839-000
6	14-18 AWG	120-1842-000	-**	120-1840-000
7  *	14-18 AWG	120-1873-000	-**	120-1874-000
8	14-18 AWG	120-1865-000	120-8552-305	120-1866-000
9	14-18 AWG	120-1867-000	120-8552-306	120-1868-000
10	14-18 AWG	120-1869-000	120-8552-307	120-1870-000

MINI SURE-SEAL®

2	18-20 AWG	120-8552-100	-	120-8551-100
3	18-20 AWG	120-8552-101	-	120-8551-101
4	18-20 AWG	120-8552-102	-	120-8551-102

POWER SURE-SEAL®

1	4-6 AWG	120-1905-000 order socket contacts	-	120-1903-000 order pin contacts
1	8-10 AWG	120-1906-000 order socket contacts	-	120-1904-000 order pin contacts

*  See [page 22](#) for special rectangular version

** Use Mounting Rings  [page 20](#)

(1) Boot

Fits over the rear of the connector and seals the jacket of the cable. It also provides additional strain relief and abrasion resistance. See dimensions on [page 20](#) for choosing 3 or 4 circuit boot.

(2) Mounting Ring

A Mounting Ring snaps into an appropriate sized hole in a panel or bracket and allows a non-flanged plug or receptacle to be panel mounted.

(3) Mounting Plate

Metal mounting plates reinforce the molded flanges when attaching flanged connectors to a panel.

Sure-Seal®



Accessories

Boot(1)	Mounting Ring(2)	Mounting Plate(3)	Posi-Lok Mounting Clip(4)	Wire Hole Filler(5)	Holding Block(6)
-	-	-	026-0452-000	225-0093-000	317-1408-002
317-1398-000	351-1640-000	066-8516-000	029-0263-000	225-0093-000	317-1408-001
317-1397-000# 317-1399-000#	351-1641-000	066-8516-000	029-0262-000	225-0093-000	317-1408-000
317-1397-000# 317-1399-000#	351-1641-000	066-8516-000	029-0262-000	225-0093-000	317-1408-000
317-8657-000	351-1633-000	-	026-0450-000	225-0093-000	317-1408-003
317-8657-000	351-1633-000	-	026-0450-000	225-0093-000	317-1408-003
317-8657-000	351-1633-000	-	026-0450-000	225-0093-000	317-1408-003
317-8657-002	351-1634-000	066-8516-002	026-0451-000	225-0093-000	317-1408-004
317-8657-002	351-1634-000	066-8516-002	026-0451-000	225-0093-000	317-1408-004
317-8657-002	351-1634-000	066-8516-002	026-0451-000	225-0093-000	317-1408-004
-	-	-	026-0452-000	225-1012-000	195-8508-013 plug 195-8508-014 receptacles
-	-	-	026-0452-000	225-1012-000	195-8508-015 plug 195-8508-016 receptacles
-	-	-	026-0452-000	225-1012-000	195-8508-017 plug 195-8508-018 receptacles
-	-	-	†	-	-
-	-	-	†	-	-

See [page 20](#) for Cable O.D. accommodations.

† Please call for availability

(4) Mounting Clip



Mounting clips can be used free-hanging as a positive lock to provide a secondary means of securing the connector halves. Mated connector pairs can be snapped into the clip for fixed mounting using a screw or cable tie. The wires of one of the connectors can be passed through an integral retention ring which captivates one of the connector halves to the clip.

(5) Wire Hole Fillers

Wire Hole fillers are inserted into unused cavities in place of a contact. Hole fillers are required to retain the watertight sealing if less than a full compliment of contacts are to be used.



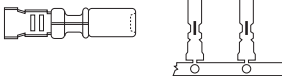
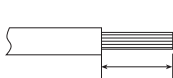
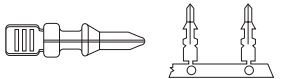

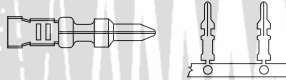
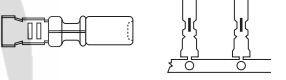
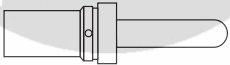
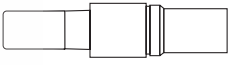

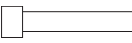
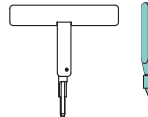

(6) Holding Block

A holding block makes insertion of contacts into the molded body faster and avoids personal injury or damage to the connector. It is highly recommended that the appropriate block be used when inserting contacts. (See Assembly Instructions, [page 25](#))

Index	Contacts ⁽¹⁾					Wire
COLUMN 1	COLUMN 2	COLUMN 3	COLUMN 4	COLUMN 5	COLUMN 6	COLUMN 7
Contact Style	A.W.G. Wire Size	Loose Pins	5K Reel Pins ⁽¹⁾	Loose Sockets	5K Reel Sockets ⁽¹⁾	Strip Length Inches (MM)
Sure-Seal® Insulation Support						
						
Tin Plated (Standard)†	14-18	030-2196-001	110238-0195	031-1267-001	110238-0194	.155 - .185
Gold Plated*†	14-18	030-2196-006	110238-0409	031-1267-005	110238-0408	(3.94 - 4.70)
Sure-Seal® Non-Insulation Support						
						
Tin Plated (Standard)	14-18	030-2196-000	110238-0040	031-1267-000	110238-0085	.185 - .220
Gold Plated*	14-18	030-2196-008	110238-0440	031-1267-007	110238-0442	(4.70 - 5.59)
Mini Sure-Seal® Insulation Support						
						
	18-20	330-8672-100	121348-0100	031-8703-100	121347-0100	.118 - .130 (3.00 - 3.30)
Power Sure-Seal® (VE)**						
						
	4	030-2245-002	-	031-1295-001	-	Note: 6 AWG & 10 AWG socket contacts have unique strip lengths .515 - .535 (13.1 - 13.6)
	6	030-2245-001	-	031-1294-001	-	
	8	030-2244-001	-	031-1299-001	-	
	10	030-2244-002	-	031-1298-001	-	
New Machined First-Make Last-Break/Pre-Earth Contacts for 120-1808-200 & 120-1805-200 for Cavity 1 Only						
Silver Plated	16-20	for 120-1808-200 use SSFMLB16-16S		for 120-1805-200 use SSFMLB16-16P		.245 (6.2)
Gold Plated	16-20	for 120-1808-200 use SSFMLB16-16SG		for 120-1805-200 use SSFMLB16-16PG		.245 (6.2)

* Silver available 50K minimum, please call.
 ** VE can be used with ITT CANNON VE connectors and Deutsch HD connectors.
 NOTE: Sure-Seal® and Mini Sure-Seal® contacts are available in machined contact versions. Call for information.
 Power Sure-Seal® contacts are machined contacts.

- (1) Loose Piece or 5K Reel**
 Contacts are available loose piece or on continuous reels of 5,000 pieces for use with semi-automated crimping systems.
- (2) Wire Hole Fillers**
 These fillers are inserted into unused cavities in place of a contact. Wire hole fillers are required to retain the watertight sealing if less than a full compliment of contacts are to be used.
- (3) Insertion Tool**
 An insertion tool is required to insert contacts into the connector. These tools are heavy duty production hand tools. A holding block should also be used during the insertion process. An extraction tool is not required. See assembly instructions. A semi-automatic insertion tool is available. See [page 25](#).

Range		Tooling					
COLUMN 8	COLUMN 9	COLUMN 10	COLUMN 11	COLUMN 12	COLUMN 13		
Wire Insulation Diameter	Wire Hole Fillers(2)	Insertion Tool (3)	Hand Crimp Tool(4)	Extraction Tool	Power/Automatic Tools(5)		
 .100 - .147 (2.54 - 3.73)	 225-0093-000 225-0093-000	 Replacement Tip 317-1153-017	 Replacement Locator 1181-92001	 DRK 152 DRK 152	 Mini Applicator (See below and pages 23-24 for more details)		
		SSI-T-Tool or 070306-0000	SSI-CS10				
.100 - .147 (2.54 - 3.73)	225-0093-000 225-0093-000	Replacement Tip 317-1153-015	Replacement Locator 1181-92001	DRK 152 DRK 152	 CBIT-SS-150 (see page 25 for more detail)		
		SS-T-Tool or 070235-0001	SS-CS10				
.055 - .071 (1.40 - 1.80)	225-1012-000	Replacement Tip MSS2000-TIP	Replacement Locator 1181-89005	DRK 32	 M3000 Crimping Press (see page 24 for more detail)		
		MSS-T-Tool or MSS-2000	MSS-CS10				
						Crimp Tool	Crimp Kit
.274 - .380 (6.96 - 9.65)	-	CIT-VE4-6	-	—	 400BHD	 Kit contains: Crimp die, Locator(s), and Go No-Go Gauge. Provide sample of wire when ordering. (Call for more information.)	
	-	CIT-VE4-6	-				
	.159 - .245 (4.04 - 6.22)	-	CIT-VE8-10				-
-		CIT-VE8-10	-				
.100 - .147 (2.54-3.73)	—	076303-0000	AF8 with TH452	DRK 152	WA27F	TH452	

▲ IMPORTANT: Use holding blocks on [page 15](#).
 Power insertion tool available, see [page 25](#).

(4) Hand Crimp Tools

These are heavy duty tools with a ratchet mechanism that will only release the contact when the crimp is completed. These tools produce consistent, high quality crimps. They are the only hand crimping tools recommended for Sure-Seal® contacts.

(5) Semi-Automatic Crimp Tools

For high volume applications, several types of semi-automatic crimping tools are available for all Sure-Seal® contacts. See [pages 23](#) and [24](#).

Mini Applicator for insulation support

For Sure-Seal® stamped contacts

Mini applicator modules are used in industry standard crimp presses. This allows for fast changeover for crimping different contacts and by using the same crimp press, saves valuable factory floor space versus having to use multiple presses.

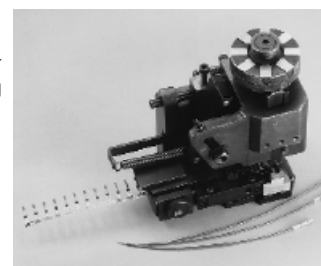

Sure Seal Plugs & Receptacles

1 Circuit

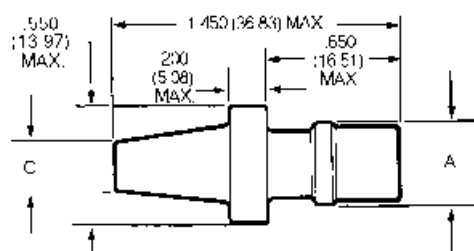

Plug P/N 120-1832-000

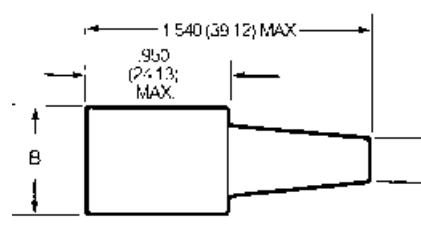

Receptacle P/N 120-1833-000

2 – 4 Circuit

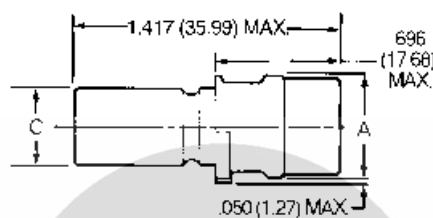

Plug

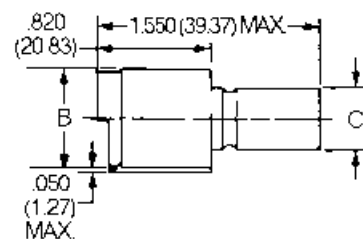

Receptacle

Body Identifier	Plug Number (P)	Receptacle No. (R)	A Dia. Max.	B Dia. Max.	C. Max.
SS-1 P/R	120-1832-000	120-1833-000	.380 (9.65)	.550 (13.97)	.230 (5.84)
SS-2 P/R*	120-1807-000	120-1804-000	.550 (13.97)	.710 (18.03)	.430 (10.92)
SS-3 P/R*	120-1808-000	120-1805-000	.600 (15.24)	.760 (19.30)	.500 (12.70)
SS-4 P/R*	120-1809-000	120-1806-000	.600 (15.24)	.760 (19.30)	.500 (12.70)

*Can use heat shrink boot: LSB1 for cable range .40 - .12

5 – 10 Circuit

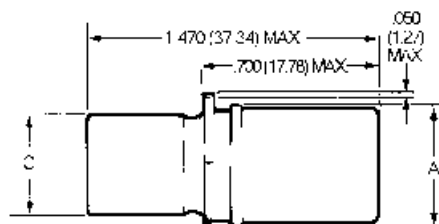

Plug

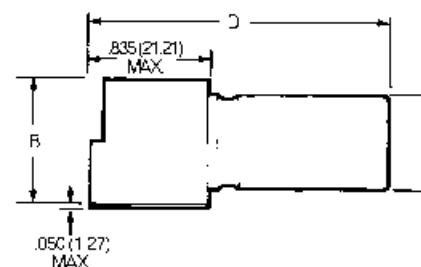

Receptacle

Body Identifier	Plug Number	Receptacle No.	A Dia. Max.	B Dia. Max.	C Max.	D Max.
SS-5 P/R*	120-1841-000	120-1839-000	1.010 (25.65)	1.160 (29.46)	.810 (20.57)	1.610 (40.89)
SS-6 P/R*	120-1842-000	120-1840-000	1.010 (25.65)	1.160 (29.46)	.810 (20.57)	1.610 (40.89)
SS-7 P/R*	120-1873-000	120-1874-000	1.010 (25.65)	1.160 (29.46)	.810 (20.57)	1.610 (40.89)
SS-8 P/R*	120-1865-000	120-1866-000	1.135 (28.83)	1.285 (32.64)	.935 (23.75)	1.610 (40.89)
SS-9 P/R*	120-1867-000	120-1868-000	1.135 (28.83)	1.285 (32.64)	.935 (23.75)	1.610 (40.89)
SS-10 P/R*	120-1869-000	120-1870-000	1.135 (28.83)	1.285 (32.64)	.935 (23.75)	1.610 (40.89)

*Can use heat shrink boot:SB2 for cable range 1.01 - 2.90

Dimensions



Sure Seal Flanged Plugs

2 – 4 Circuit

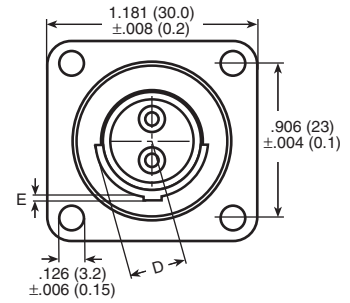
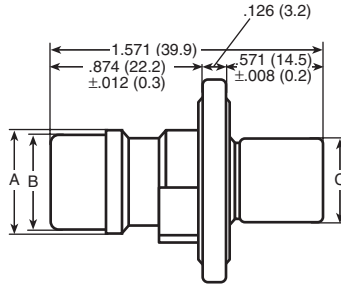

Use with Mounting Plate #066-8516-000

Body Identifier	Part Number	A Dia. +.12 (0.3)	B Dia. +.008 (0.2)	C Dia. +.012 (0.3)	D Dia. +.012 (0.3)	E +.008 (0.2)
SSF-2P	120-8552-200	.547 (13.9)	.524 (13.3)	.425 (10.8)	.307 (7.8)	.039 (1.0)
SSF-3P	120-8552-201	.598 (15.2)	.583 (14.8)	.484 (12.3)	.315 (8.0)	.020 (0.5)
SSF-4P	120-8552-202	.598 (15.2)	.583 (14.8)	.484 (12.3)	.354 (9.0)	.039 (1.0)

8 – 10 Circuit

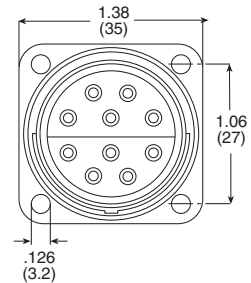
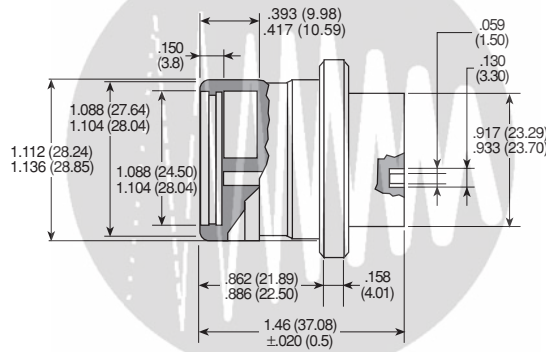

Use with Mounting Plate #066-8516-002 or #066-8516-003

Body Identifier	Plug Number
SSF-8P	120-8552-305
SSF-9P	120-8552-306
SSF-10P	120-8552-307

Mini-Sure-Seal Plugs & Receptacles

2 – 4 Circuit

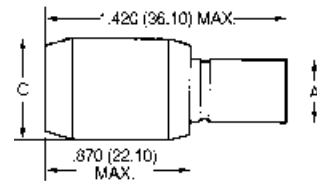
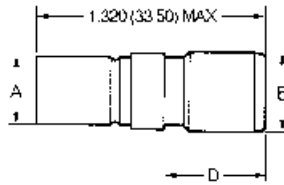

Plug

Receptacle

Body Identifier	Plug (P) Part Number	Receptacle (R) Part Number	A Dia. Max.	B Dia. Max.	C Dia. Max.	D Max.
MSS-2 P/R*	120-8552-100	120-8551-100	.340 (8.64)	.390 (9.91)	.540 (13.72)	.550 (13.97)
MSS-3 P/R*	120-8552-101	120-8551-101	.360 (9.15)	.420 (10.67)	.580 (14.74)	.550 (13.97)
MSS-4 P/R*	120-8552-102	120-8551-102	.360 (9.15)	.450 (11.43)	.610 (15.50)	.550 (13.97)

*Can use heat shrink boot: LSB1 for cable range .40 - .12

Dimensions



Power Sure-Seal®

Plug



Body Identifier	Part Number	AWG Size
SS-1P-4	120-1905-000	#4 or #6
SS-1P-8	120-1906-000	#8 or #10

Order Socket Contacts

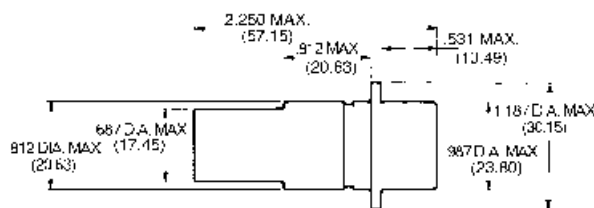

Plug

Receptacle



Body Identifier	Part Number	AWG Size
SS-1R-4	120-1903-000	#4 or #6
SS-1R-8	120-1904-000	#8 or #10

Order Pin Contacts

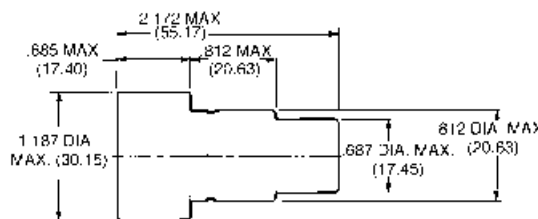

Receptacle

Accessories

Boot



Fits over the rear of the connector and seals the jacket of a multi-conductor cable. Also provides additional strain relief and abrasion resistance.

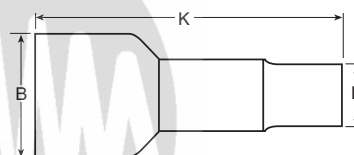

NEW!

Call for new overmolded options

Body Identifier	Part Number	B Dia. Max.	Cable O.D.	K Ref.	D Dia. Max.
SS-2 Boot	317-1398-000	.650 (16.51)	.208-.228 (5.28-5.79)	2.050 (52.07)	.380 (9.65)
SS-3 Boot+	317-1397-000	.610 (15.50)	.220-.240 (5.59-6.10)	2.050 (52.07)	.380 (9.65)
SS-4 Boot+	317-1399-000	.750 (19.05)	.345-.380 (8.76-9.65)	2.050 (52.07)	.500 (12.70)
SS-5-7 Boot	317-8657-000	1.063 (27.00)	.283-.331 (7.20-8.40)	2.441 (62.00)	.492 (12.50)
SS-8-10 Boot	317-8657-002	1.220 (31.00)	.394-.488 (10.00-12.40)	2.480 (63.00)	.732 (18.60)

Note: In addition to boot, remember to use 225-0093-000 Wire Hole Fillers to fill any unused contact cavities.

+ May be used to cover industry standard BNC crimp style plugs. Call for more information.

Shrink boots available. 120-2G & SB2. Call for details.

➔ See [page 14](#) for matching plugs and receptacles chart.

Mounting Ring



A Mounting Ring snaps into an appropriate sized hole in a panel or bracket and allows a non-flanged plug or receptacle to be panel mounted.

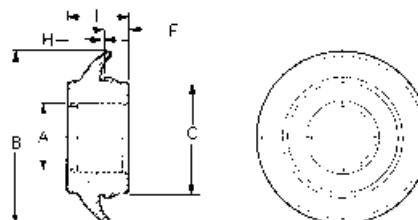

Part Number	A Dia. Max.	B Dia. Max.	C Dia. Max.	F Max.	H Ref.	L Max.	Hole Diameter	Panel Thickness
351-1640-000	.410 (10.41)	1.275 (32.39)	.790 (20.07)	.230 (5.84)	.055 (1.40)	.690 (17.53)	.781 (19.84)	.060 (1.52)
351-1641-000	.470 (12.06)	1.275 (32.39)	.790 (20.07)	.230 (5.84)	.055 (1.40)	.690 (17.53)	.781 (19.84)	
351-1633-000	.755 (19.05)	2.200 (56.64)	1.445 (36.70)	.330 (8.38)	.065 (1.65)	.830 (21.08)	1.50 (38.12)	
351-1634-000	.875 (22.23)	2.200 (56.64)	1.445 (36.70)	.330 (8.38)	.065 (1.65)	.830 (21.08)	1.50 (38.12)	

➔ See [page 14](#) for matching plugs and receptacles chart.



Mounting Plate

For 2 – 4 Circuit Plug



066-8516-000 for use with
120-8552-200
120-8552-201
120-8552-202

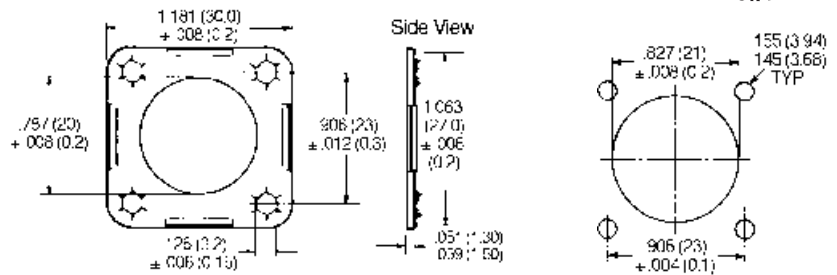

Mounting Dimensions



Use Nut plate part number M85528/2-14A.
Use Sealing Screws for mounting, see Accessories page 22.

For 8 – 10 Circuit Plug



066-8516-002 (Through-Hole) for use with
120-8552-305
120-8552-306
120-8552-307

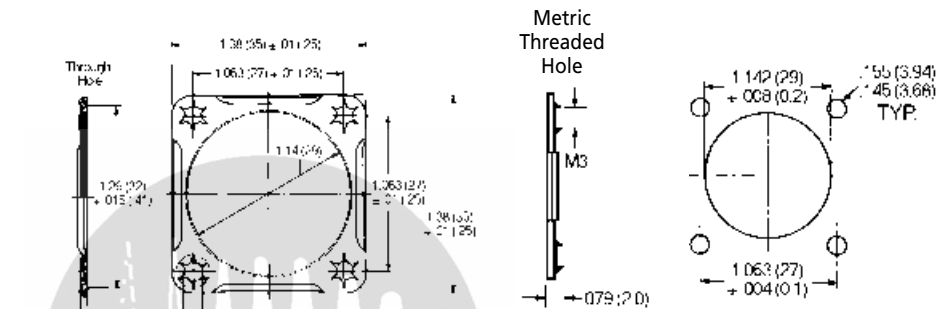

Mounting Dimensions



Use Nut plate part number M85528/2-18A.
Use Sealing Screws for mounting, see Accessories page 22.

Mounting Clip (Sure-Seal® only)

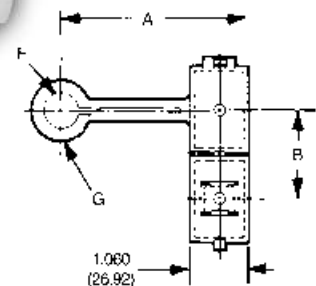
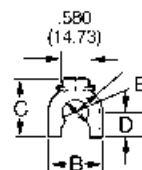
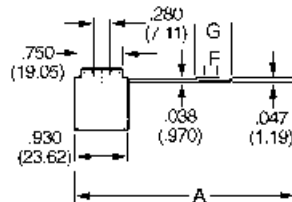
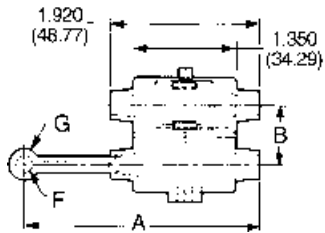
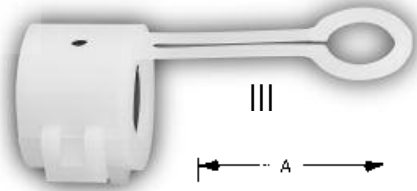
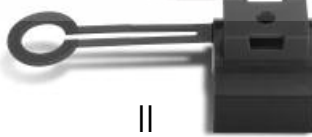

Style	Body Identifier	Part Number	Colors	A Max.	B +/- .01	C	D	E	F Max.	G Max.
I	SS-1C	026-0452-000	Black	3.185 (80.89)	.740 (18.80)	-	-	-	.210 (5.33)	.390 (9.91)
II	SS-2C	029-0263-000	Red	2.443 (62.04)	.886 (22.50)	1.000 (25.40)	.420 (10.67)	.420 (10.67)	.400 (10.16)	.650 (16.51)
II	SS-3-4C	029-0262-000	Yellow	2.443 (62.04)	.926 (23.52)	1.053 (26.74)	.450 (11.43)	.480 (12.19)	.400 (10.16)	.650 (16.51)
III	SS-5-7C	026-0450-000	Natural	3.045 (77.34)	1.395 (35.43)	-	-	-	.610 (15.49)	.910 (23.11)
III	SS-8-10C	026-0451-000	Black	3.045 (77.34)	1.520 (38.61)	-	-	-	.660 (16.76)	.960 (24.38)



Rectangular Sure-Seal® Connector



Part Number
120-1873-007

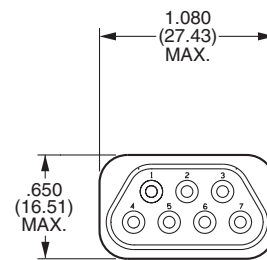
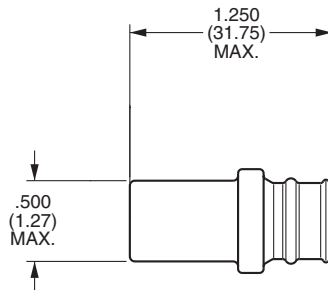
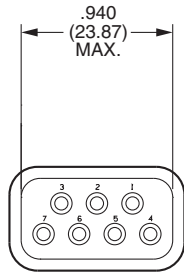

Part Number
120-1874-007

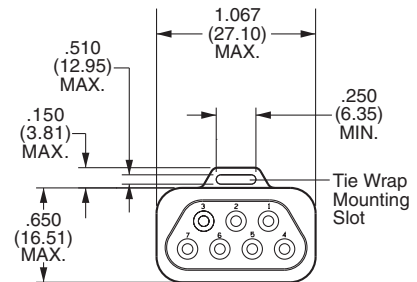
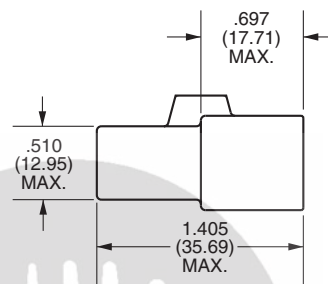
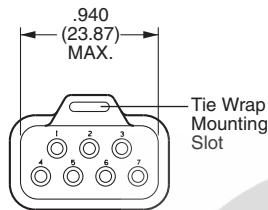

Accessories

Sealing Screws

Sealing screws are designed with a groove underneath the head to incorporate an O-ring. When tightened, the O-ring is compressed against the connector flange to form an air, water, and gas-tight seal. Sealing screws are used in conjunction with the nut plates below.

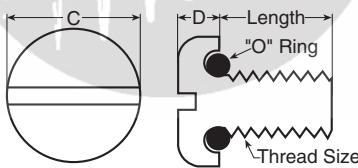

(S) Slotted Pan Head

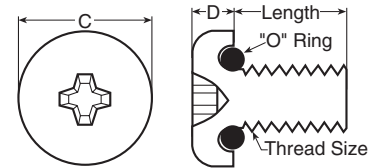

(R) Phillips Pan Head

Part Number	Thread	Length	C Max	D Max	Clear Hole	
					Min	Max
S440-1/2	4-40NC-2A	1/2"	.220"	.069"	.125"	.129"
R440-1/2	4-40NC-2A	1/2"	.238"	.080"	.125"	.129"

Nut Plates

Nut plates should be used in conjunction with mounting plates. Nut plates eliminate the need for loose nuts which are often difficult to negotiate in confined areas. As well, they effectively distribute the screw tension across the back of the panel. The bracket is aluminum alloy with Alodine plating, and the nuts are steel alloy plated cadmium. Nut plates mate with above sealing screws.

Nut Plate P/N (uses 4-40 screws)	For Sure-Seal P/Ns
M85528/2-14A	120-8552-200
	120-8552-201
	120-8552-202
M85528/2-18A	120-8552-305
	120-8552-306
	120-8552-307



Wire and Jacketed Cable Preparation

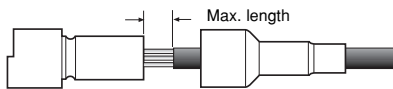

Strip wires to appropriate length (See contact chart on [page 16](#) for strip lengths). If using a boot, strip jacket so no more than listed dimension is exposed when contact is full inserted.

Note: Try stripping back jacket approximately **1.25 inches (32mm)** because strip lengths will vary depending on cable being used.

# Circuits	Max. exposed length Inches (mm)
2, 3, 4	.87 (22)
5, 6, 7	1.02 (26)
8, 9, 10	1.02 (26)

Sure Seal® Hand Crimp Tool Operation Instructions

The Sure Seal hand crimp tool has a full cycle ratchet controlled release and straight action crimp jaws. The flap locator makes it easy to load the terminal and the pre-positioner assures that the terminal is loaded for proper crimping. To open the tool, you must apply force to the handles to allow the tool to spring open.



1. Open hand crimper by squeezing handles until handles spring open.



2. Open flap locator. Insert contact up to stop. Make sure contact is inserted properly.



3. Close flap locator.



4. Press pre-positioner downward firmly for contact alignment. (crimp area should be facing upward).



5. Pre-close the handles



6. (Above, left) Insert stripped* wire into contact up to insulation stop.



7. (Above, right) Squeeze handles until they pop open. Remove contact from locator.

Hand Tool Part Number	Contact Type	For Contacts		Wire Strip Length
		Pin	Socket	
SSI-CS10	Insulation Support	030-2196-001	031-1267-001	.155-.185 (4.0-4.7)
		030-2196-006	031-1267-005	
SS-CS10	Non-Insulation Support	030-2196-000	031-1267-000	.185-.220 (4.7-5.6)
		030-2196-008	031-1267-007	
MSS-CS10	Mini	330-8672-100	031-8703-100	.118-.130 (3.0-3.3)

Tool Maintenance: Maintenance and inspection should be performed regularly. The tool should be wiped clean with special emphasis on crimping cavities. The tool may be cleaned by immersing in a suitable commercial solvent or cleaner that does not attack paints or plastic material. The tool should be re-lubricated after cleaning using a light film of a medium weight oil on bearing surfaces and pivot pins. When not in use, keep handles closed to prevent objects from becoming lodged in the crimping dies. Store in a clean dry area.

Power Sure-Seal® Machined Contact Crimp Tool

400BHD



The 400BHD is a pneumatically power heavy duty crimp tool designed for contacts that are too large to be crimped by hand tools. The 400BHD comes with a power unit and bench mounting bracket. The 400BHD is actuated with either the standard handle actuating switch or optional Pneumatic Foot Pedal (PFP). Crimp Die Kits are ordered separately (see [page 17](#)). It is highly recommended that you provide a sample of your wire when ordering these Crimp Die Kits. Your wire sample will be crimped and tested for proper crimp tensile strength.

Power Requirements: 90-125 PSI 1-2 CFM of dry, oil free, air

Operating Instructions: (Call for operating instructions)

Semi/Automatic Crimp Tooling

Mini Applicator

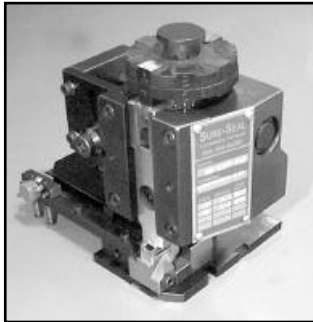

For lease or purchase

The Sure-Seal mini-applicator is designed for use in most common crimping presses and automatic wire processing systems. It utilizes a quick change mounting system, which allows the applicator to be installed or removed in two quick steps. This makes the change over from one applicator to another for crimping a variety of contacts utilizing the same press fast and easy. We offer this side-feed applicator for our most popular stamped and formed terminals (see below).

Applicator	Terminal
SSMA-SSI	110238-0195 & 110238-0194
SSMA-SS	110238-0040 & 110238-0085
MSSMA-SSI	121348-0100 & 121347-0100

M3000 Crimping Press



For lease or purchase

The M3000 crimping press is compatible with most side-feed mini-applicators for automated terminal crimping and is the most economical "state-of-the-art" crimping press on the market. The M3000 accommodates our mini-applicator listed above as well as most "left-to-right" and "rear" quick change "mini" style applicators. Other features include precision crimp height adjustment, electronically interlocking safety guard, jog cycle and 110V power supply.

Crimp monitors and counters are also available. Call for more information.

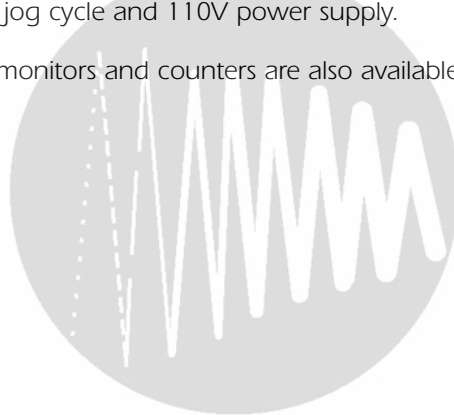

Crimp Inspection

Micro sections: Enlargement of micro section allows for final judgment of crimp quality. This test is recommended whenever new tools or new types of wire are used.

NOTE: For accurate pull test results when crimping insulation support contacts (030-2196-001 & 031-1267-001), strip wire back .3" so that the insulation support tine does not crimp onto insulation.

- 1 insulation
- 2 strands
- 3 contact
- 4 wire inspection hole
- 5 shoulder

For machined power contacts

Correct Crimp

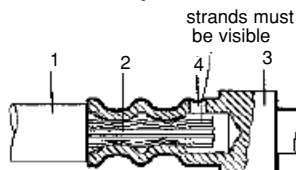

Incorrect Crimp

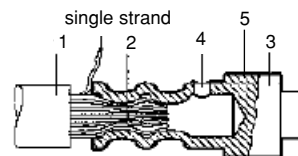

For stamped contacts

Correct Crimp

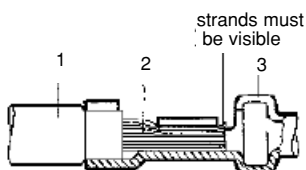

Incorrect Crimp

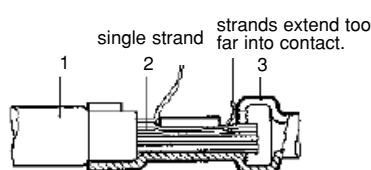

Incorrect Crimp

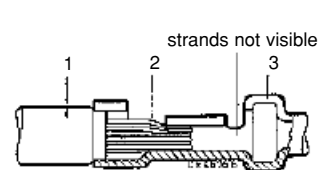

Manual Insertion of Contacts

1. Affix proper connector holding block to stable surface (i.e. vice or table). See Connector Selection table, [▶ page 15](#), for proper holding block.
2. If a jacket wire sealing boot is to be used, it must be slid up the cable (isopropyl alcohol will help in doing this).
3. Dip connector in isopropyl alcohol and place in holding block with the back end up (wire side).
4. Using proper contact insertion tool, (see [▶ page 15](#) Contact Selection table for proper tool):
 - A. place contact in groove of tool
 - B. make sure that end of the tool is up against the shoulder of the contact.
5. Insert contact into proper cavity of the connector body by applying constant pressure until contact snaps into place. Isopropyl alcohol will help in doing this. (Warning: Do not tilt the tool during the insertion).
6. Insert all remaining contacts. To insure environmental sealing of the connector any empty contact cavities must be filled with wire hole fillers (see Contact Selection table, [▶ page 15](#), for proper wire hole filler).
7. Check mating side of the connector to be sure that all contacts are on the same plane (fully inserted).
8. If you are using jacket sealing boot, slide the boot down the cable and onto the connector.
9. Remove connector and wire assembly from holding block.

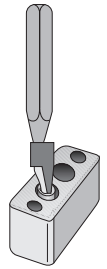
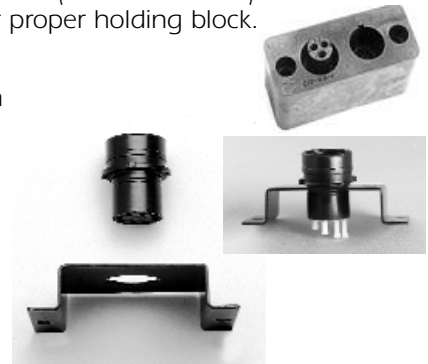

Pneumatic Automatic Insertion Tool (Leased)

CBIT-SS-150



For lease only

The CBIT-SS-150 Sure-Seal® insertion machine is pneumatically powered, and micro-processor controlled. It is designed to insert pre-crimped wires into the standard Sure-Seal® plug and receptacle housings for moderate to high volume applications. This machine is used for SS2P/R through SS10P/R including the 120-1873-007 and 120-1874-007 rectangular style Sure-Seal® connectors.

The benefits of using this insertion machine are:

- Ease of operation Short operator training time
- Low cycle time Reduces operator fatigue and insertion errors
- High connector integrity Quick change over for different connectors sizes
- Much faster than manual insertion
- Lower chance of damaging the wire sealing ripples

Power Requirements:

Electrical = 115 Vac, 60 Hz

Pneumatic = 80 PSI, 10 CFM dry oil free filtered air

Extraction of Contacts



1. Slide up any rear accessories (i.e. jacket cable sealing boots). Using isopropyl alcohol will help you slide these up your cable.
2. Grasp individual wire firmly and gently pull the contact out of the connector.

* Extraction tool available DRK32 & DRK152, please call.

Test Data

Sure-Seal® Circular Connectors

Typical: Power Sure-Seal®, Flange Sure-Seal®, and Mini Sure-Seal® are essentially the same except for mechanical and amperage capacity differences. Sure-Seal® products are designed to meet specification CS-155. Items of most general interest to users and designers are listed below. With its current capability and large size, Power Sure-Seal® contacts and currents are covered in CS-169.

Test Description	Reference Paragraph	Requirements																																				
Environmental Sealing	3.5.1	Sure-Seal® connectors when mated shall form an environmental seal against water, moisture, aqueous solutions, oils and certain chemicals as well as dust and dirt. Tests include immersion in 3 feet depth in water solution containing 5% salt.																																				
Contact Tensile Strength-Crimp	3.6.12	The minimum tensile load required to separate the wire from the contact, either by pulling the wire out of the crimp joint or breaking the wire within the crimp joint, shall not be less than the applicable limits as specified. Wire breakage, or contact damage not due to crimping, at less than tensile loads shall not constitute failure.																																				
		Crimp Tensile Strength, Pounds Minimum																																				
		<table border="1"> <thead> <tr> <th>Wire Size AWG</th> <th>Without Insulation Support Contacts</th> <th>With Insulation Support Contacts</th> <th>Wire Size AWG</th> <th>Without Insulation Support Contacts</th> <th>With Insulation Support Contacts</th> <th>Wire Size AWG</th> <th>Without Insulation Support Contacts</th> <th>With Insulation Support Contacts</th> </tr> </thead> <tbody> <tr> <td>4</td> <td>140</td> <td>—</td> <td>10</td> <td>80</td> <td>—</td> <td>18</td> <td>25</td> <td>25</td> </tr> <tr> <td>6</td> <td>100</td> <td>—</td> <td>14</td> <td>35</td> <td>35</td> <td>20</td> <td>—</td> <td>20</td> </tr> <tr> <td>8</td> <td>90</td> <td>—</td> <td>16</td> <td>35</td> <td>35</td> <td></td> <td></td> <td></td> </tr> </tbody> </table>	Wire Size AWG	Without Insulation Support Contacts	With Insulation Support Contacts	Wire Size AWG	Without Insulation Support Contacts	With Insulation Support Contacts	Wire Size AWG	Without Insulation Support Contacts	With Insulation Support Contacts	4	140	—	10	80	—	18	25	25	6	100	—	14	35	35	20	—	20	8	90	—	16	35	35			
		Wire Size AWG	Without Insulation Support Contacts	With Insulation Support Contacts	Wire Size AWG	Without Insulation Support Contacts	With Insulation Support Contacts	Wire Size AWG	Without Insulation Support Contacts	With Insulation Support Contacts																												
4	140	—	10	80	—	18	25	25																														
6	100	—	14	35	35	20	—	20																														
8	90	—	16	35	35																																	
Insulation Resistance	4.4.1	Properly assembled and mated connectors shall be tested in accordance with MIL-STD-202, Method 302, except a potential of 500 ± 15 volt DC shall be used. The resistance shall be measured between adjacent parts of contacts (or contacts to ground for SS-1) and shall not be less than 100 M. If the specimen has been immersed in fluid in the preceding test, it shall be placed wet on a conducting surface and insulation resistance measured within 5 minutes between each contact and also between each contact and the conducting surface (except for SS-1 to be measured contact to ground while immersed).																																				
Dielectric Withstanding Voltage	4.4.2	Assembled and mated connectors shall show no evidence of breakdown between adjacent contacts (or contact to ground for SS-1) when tested in accordance with MIL-STD-202, Method 301, and a test voltage of 1200 ± 15 volts A.C.																																				
Contact Resistance	4.4.3	The contact resistance of mated contacts shall be such that the resistance measured across the contacts and 5/8" behind the crimp junction shall not exceed 10 mΩ. Test current to be 1 amp, and MIL-STD-202, Method 307.																																				
Shock	4.4.4	Mated connectors properly mounted shall be subjected to the shock test in accordance with MIL-STD-202, Method 213B, CONDITION B. The shock test shall be repeated three (3) times in each of X, Y & Z axis. Suitable means shall be employed to monitor the current flow. Current discontinuity of 1 microsecond or more, disengagement of the mated connectors, evidence of cracking, breaking or loosening of parts shall be cause for rejection.																																				
Vibration	4.4.5	Properly assembled and mated connectors shall be mounted to the vibration table, with the wire leads strapped to a vibrating member approximately 3 inches from each end of the connector body and vibrated with a peak-to-peak amplitude of .25 inch across a frequency range of 5 to 39Hz, and a ±20g acceleration across 39 to 55 Hz, swept up in one minute and down in another minute. The vibration shall be swept up and down for a total of 36 hours under the following conditions: Six (6) hours at 180°F (82°C) along the longitudinal axis Six (6) hours at 180°F (82°C) along a perpendicular axis Six (6) hours at room temperature along the longitudinal axis Six (6) hours at room temperature along a perpendicular axis Six (6) hours at -40°F (-40°C) along the longitudinal axis Six (6) hours at -40°F (-40°C) along a perpendicular axis The connectors shall be connected in a series circuit with a minimum of 0.1 ampere flowing through the contacts. Electrical continuity shall be continually monitored. Breaks in continuity longer than one microsecond shall be cause for rejection.																																				
Durability	4.4.6	The connectors shall be subjected to 25 cycles of mating and unmating at -10°C and another 25 cycles at 50°C. There shall be no evidence of damage to the contacts, the contact plating, the insulators or sealing rings, which would be detrimental to connector function.																																				
Contact Retention	4.4.7	With the connector plug or receptacle held firmly, an axial dead weight of 7.5 lbs. shall be imposed on each wire for one minute without the contacts being dislodged from the connector. Plugs and receptacles to be tested separately.																																				
Maintenance Aging	4.4.8	Each wired receptacle and plug shall be subjected to 5 cycles of contact insertion and extraction in the same cavity using the approved tools. Plug and receptacle are to be tested separately. After the 5 cycles of insertion and extraction, each plug and receptacle in turn will be subjected to the contact retention test of 6 lbs. per paragraph 4.4.7.																																				
Connector Separating Force	4.4.11	Using an assembled and mated connector with the receptacle held firmly by the wires, a load shall be applied to the wires of the plug until the connector is completely separated. The rate of loading shall be one inch per minute. The sample shall fall within the limits specified as follows:																																				
		<table border="1"> <thead> <tr> <th rowspan="2">Connector Size</th> <th colspan="2">Unmating Forces (lbs.)</th> <th rowspan="2">Connector Size</th> <th colspan="2">Unmating Forces (lbs.)</th> </tr> <tr> <th>Max.</th> <th>Min.</th> <th>Max.</th> <th>Min.</th> </tr> </thead> <tbody> <tr> <td>SS-1</td> <td>12</td> <td>6</td> <td>SS-4</td> <td>20</td> <td>9</td> </tr> <tr> <td>SS-2</td> <td>15</td> <td>6</td> <td>SS-5/7</td> <td>30</td> <td>10</td> </tr> <tr> <td>SS-3</td> <td>18</td> <td>8</td> <td>SS-8/10</td> <td>55</td> <td>10</td> </tr> </tbody> </table>	Connector Size	Unmating Forces (lbs.)		Connector Size	Unmating Forces (lbs.)		Max.	Min.	Max.	Min.	SS-1	12	6	SS-4	20	9	SS-2	15	6	SS-5/7	30	10	SS-3	18	8	SS-8/10	55	10								
		Connector Size		Unmating Forces (lbs.)			Connector Size	Unmating Forces (lbs.)																														
Max.	Min.		Max.	Min.																																		
SS-1	12	6	SS-4	20	9																																	
SS-2	15	6	SS-5/7	30	10																																	
SS-3	18	8	SS-8/10	55	10																																	
Solvent Resistance	4.4.13	Wired and mated connectors shall be subjected to the applicable fluids for the length of time specified. Following the test the connectors shall be immersed to a depth of 3 feet in salt water for 24 hours at room temperature. At the completion of the salt water immersion test and while still immersed insulation resistance shall be measured. Failure to meet the insulation resistance requirements shall be cause for rejection.																																				
	4.4.14	Gasoline Splash 1 second dip - 3 minute air dry for 80 cycles at room ambient temperature.																																				
	4.4.15	Diesel Fuel Splash 1 second dip - 3 minute air dry for 80 cycles at room ambient temperature.																																				
	4.4.16	Automotive Lubricating Oil Immersed in S.A.E. 30 weight lubricating oil for 1 hour.																																				
	4.4.17	Antifreeze Immersed at 120°F (49°C) for 48 hours.																																				
	4.4.18	Brake Fluid Immersed at room ambient temperature for 24 hours.																																				
	4.4.19	Automatic Transmission Fluid Immersed at 120°F (49°C) for 48 hours. Gasoline Vapor Immersed in a gasoline vapor atmosphere at room temperature for 48 hours.																																				
Weather and Ozone Resistance	4.4.20	Wired and properly mated connectors shall be subjected to ozone test per ASTM D-1149 except that 100 ppm of ozones shall be used. The duration of the test shall be 7 days. Outdoor exposure to be conducted per ASTM D-1171. The connector shall show no cracking or other degradation which would result in loss of sealing integrity.																																				
High Temperature Long-Term	4.4.23	Wired mated connectors shall be tested in accordance with MIL-STD-202 Method 108A, Test Condition D at 105°C for 1000 hours. Following the test, they shall be subjected to 3 feet salt water immersion for 24 hours. While immersed, insulation resistance shall be determined. Failure to meet the insulation resistance requirements shall be cause for rejection.																																				
UV	-	Sure Seal Connections has recently completed testing of the Sure Seal PVC Nitrile material (SM 3400-06) for UV resistance. The material was tested in accordance with ASTM G-26 (Xenon Arc), 720 hours exposure with no loss in tensile strength and greater than 75% retention of elongation.																																				

Caution: "Sure-Seal® connectors are rated for use between temperatures of -40 to + 105 degrees Celsius. However, if a Sure-Seal® connector is exposed for long periods of time to temperatures exceeding 85 degrees Celsius and is unmated, it may lose its environmental sealing integrity upon remating. Thus, we recommend that both the plug and receptacle be replaced if environmental sealing is required after remating."

X-ON Electronics

Largest Supplier of Electrical and Electronic Components

Click to view similar products for [I/O Connectors](#) category:

Click to view products by [ITT](#) manufacturer:

Other Similar products are found below :

[571763P](#) [58098-0628](#) [61-168618-12P](#) [D38999/20FJ24PA L/C](#) [D38999/20FJ29SB L/C](#) [D38999/24FG11SN L/C](#) [72.250.1628.2](#) [72.250.2428.2](#)
[74720-0505](#) [76.350.0729.0](#) [76871-1403](#) [FCN-244F080-G/1](#) [FCN-260A9920](#) [FCN-268D024-G/2F#10X-R10](#) [PCS-E50FA](#) [PCS-XE26LKA](#)
[PCS-XE26MA+](#) [PCS-XES68MS+](#) [G38A71314B](#) [91-569719-35R](#) [9776-18-6](#) [DX40-50P\(55\)](#) [1571250010](#) [157-22500-3](#) [MS3476W12-10S](#)
[L/C](#) [1888020-8](#) [91-569786-35H](#) [91-569786-35M](#) [91-644626-35P](#) [172501-4002](#) [172501-6002](#) [FCN-260C008-A/L0](#) [FCN-260C024-AL0](#)
[FCN-261Z008](#) [FCN-268D008-G/1K](#) [2000314-1](#) [200331-1](#) [2007498-2](#) [PCR-E28LMDAG1+](#) [PCR-E36FC+](#) [PCS-E28FS+](#) [PCS-XE26SLFD+](#)
[PCS-XE26SLFDT+](#) [G38A71214B](#) [HDRA-E68W1LFDTC-SL+](#) [HDR-E14MSG1+](#) [R88A-CNK81S](#) [CRT1-ATT02](#) [54182-0605](#)
[U90B2054081210](#)