

# CR2016

3V Lithium Battery  
Swiss Made

## Technical Data Sheet

### Specifications

Chemical System	Li / MnO <sub>2</sub>
Nominal Voltage	3 V
Rated Capacity	80 mAh
Standard Discharge Current	0,2 mA
Max. Cont. Discharge Current	3,5 mA
Average Weight	1,7 g
Temperature Range	-30 - +70 °C
Self Discharge at 23°C	< 1% / year

### Dimensions

(According to IEC 60086)

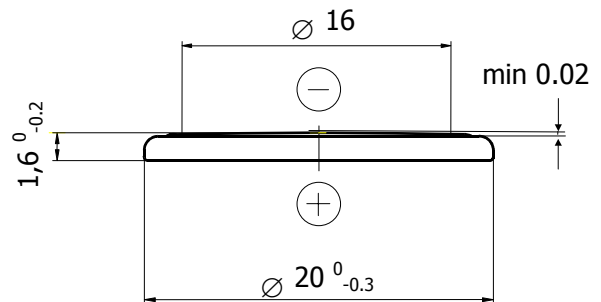

### Performance

Discharge performance at 23°C

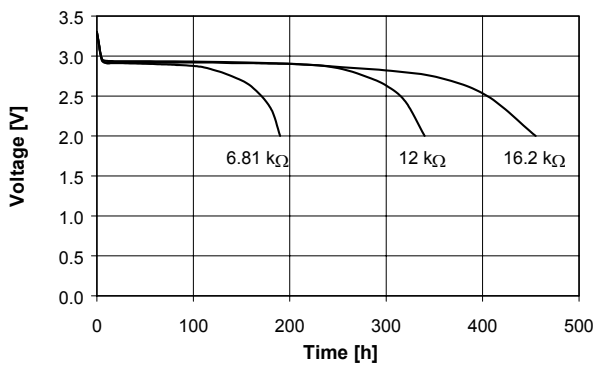

Discharge performance at 23°C

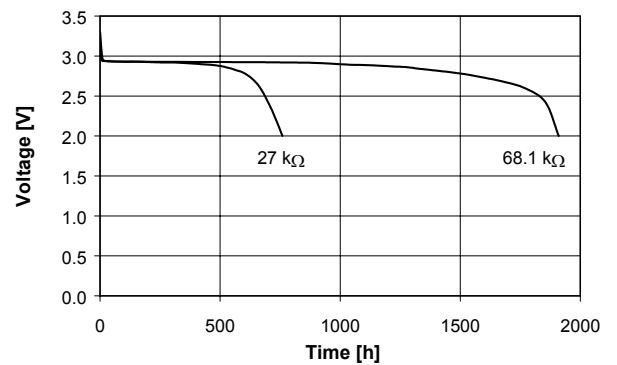

Temperature performance Load 27kΩ

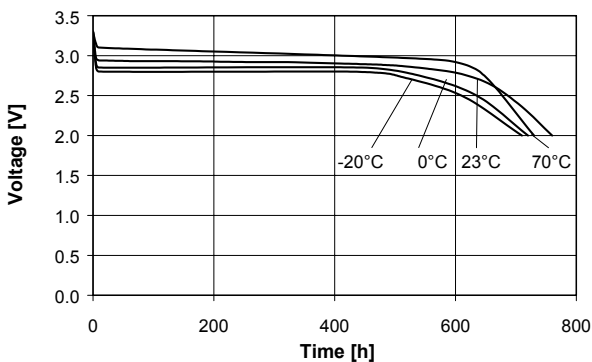

Cell capacity at various loads

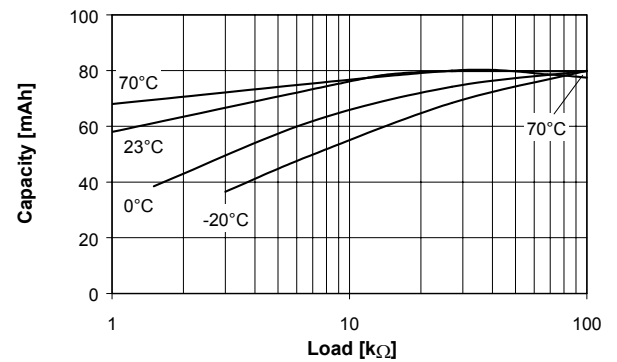

Rev. CR2016.04 10/01

## **X-ON Electronics**

Largest Supplier of Electrical and Electronic Components

*Click to view similar products for [renata](#) manufacturer:*

Other Similar products are found below :

[095995R](#) [CR1225](#) [SMTU 2477N-1-LF](#) [SMTU 2430-1-LF](#) [SMTU1632-LF.TR](#) [SMTU1632-C.TR](#) [SMTU 2450N-1-LF](#) [CR2025 MFR.IB](#) [HU](#)  
[2450N-1-LF](#) [HU2430-LF](#) [HU2450N-LF](#) [SMTU2450N-LF.TR](#) [SMTU2032-LF](#) [SMTU2450N-LF BULK](#) [HU357-LF](#) [CR1220 MFR.IB](#)  
[NL5077-LF](#) [NH5077-LF](#) [SMTU2430-LF.TR](#) [CR2032 \(R\)](#) [SMTU 1225-1-LF](#) [SMTM1632](#) [SMTU2450N-LF](#) [SMTU357-LF](#)