

## Printed-circuit board connector - DMC 1,5/ 3-G1-3,5 P20THR - 1786840

Please be informed that the data shown in this PDF Document is generated from our Online Catalog. Please find the complete data in the user's documentation. Our General Terms of Use for Downloads are valid (<http://phoenixcontact.com/download>)

Header, Nominal current: 8 A, Rated voltage (III/2): 160 V, Number of positions: 3, Pitch: 3.5 mm, Color: black, Contact surface: Tin, Mounting: SMD/THT/THR



The figure shows a 10-pos. version with 20 contacts

### Product Features

- Taped headers available on request
- Headers with flange can be combined with plugs with screw flange or with Lock & Release levers
- At 8 mm, the distance from the edge of the PCB to the first row of holes is compatible with MC headers
- Extremely small THR double-level headers for SMT and wave soldering processes



### Key commercial data

Packing unit	1 pc
Weight per Piece (excluding packing)	2.0 GRM
Custom tariff number	85366990
Country of origin	Germany

### Technical data

#### Dimensions

Length	11.6 mm
Height	12.8 mm
Pitch	3.5 mm
Dimension a	7 mm
Pin dimensions	0,8 x 0,8 mm
Pin spacing	2.50 mm
Hole diameter	1.4 mm

#### General

Range of articles	DMC 1,5/...G1-THR
-------------------	-------------------

# Printed-circuit board connector - DMC 1,5/ 3-G1-3,5 P20THR - 1786840

## Technical data

### General

Insulating material group	IIIa
Rated surge voltage (III/3)	2.5 kV
Rated surge voltage (III/2)	2.5 kV
Rated surge voltage (II/2)	2.5 kV
Rated voltage (III/3)	160 V
Rated voltage (III/2)	160 V
Rated voltage (II/2)	250 V
Connection in acc. with standard	EN-VDE
Nominal current I <sub>N</sub>	8 A
Maximum load current	8 A
Insulating material	LCP
Inflammability class according to UL 94	V0
Color	black
Number of positions	3

## Classifications

### eCl@ss

eCl@ss 4.0	272607xx
eCl@ss 4.1	27260701
eCl@ss 5.0	27260701
eCl@ss 5.1	27260701
eCl@ss 6.0	27260704
eCl@ss 7.0	27440402
eCl@ss 8.0	27440402

### ETIM

ETIM 4.0	EC002637
ETIM 5.0	EC002637

### UNSPSC

UNSPSC 6.01	30211810
UNSPSC 7.0901	39121409
UNSPSC 11	39121409
UNSPSC 12.01	39121409
UNSPSC 13.2	39121409

# Printed-circuit board connector - DMC 1,5/ 3-G1-3,5 P20THR - 1786840

## Approvals

### Approvals

---

#### Approvals

UL Recognized / cUL Recognized / VDE Gutachten mit Fertigungsüberwachung / IEC60335 CB Scheme / cULus Recognized

---

#### Ex Approvals

---

#### Approvals submitted

---

## Approval details

UL Recognized 		
	B	C
Nominal current I <sub>N</sub>	8 A	8 A
Nominal voltage U <sub>N</sub>	150 V	50 V

cUL Recognized 		
	B	C
Nominal current I <sub>N</sub>	8 A	8 A
Nominal voltage U <sub>N</sub>	150 V	50 V

VDE Gutachten mit Fertigungsüberwachung 	
Nominal current I <sub>N</sub>	8 A
Nominal voltage U <sub>N</sub>	160 V

# Printed-circuit board connector - DMC 1,5/ 3-G1-3,5 P20THR - 1786840

## Approvals

IECEE CB Scheme	
Nominal current I <sub>N</sub>	8 A
Nominal voltage U <sub>N</sub>	160 V

cULus Recognized	
------------------	--

## Drawings

Schematic diagram

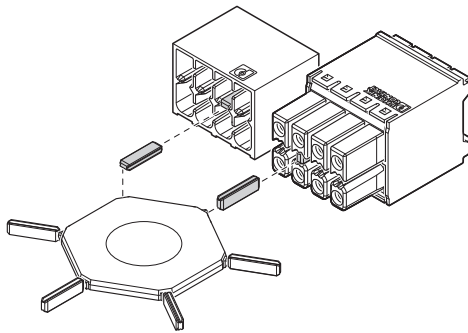

Drilling diagram

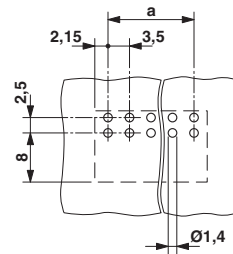

Use of the CP-DMC... coding profile

Diagram

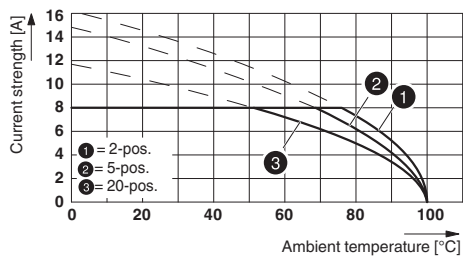

Dimensioned drawing

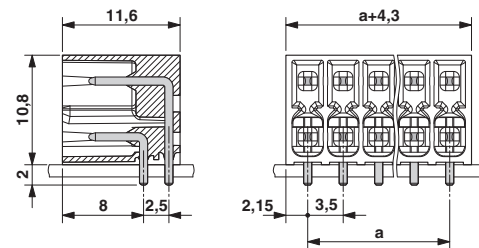

## X-ON Electronics

Largest Supplier of Electrical and Electronic Components

*Click to view similar products for [Headers & Wire Housings](#) category:*

*Click to view products by [Phoenix Contact](#) manufacturer:*

Other Similar products are found below :

[95000-104TRLF](#) [10135584-644402LF](#) [DF62W-EP2022PCA](#) [95000-106TRLF](#) [DF62W-2022SCA](#) [DF62W-EP2022PC](#) [2203348](#) [DF62W-2022SC](#) [1084018](#) [1029039](#) [1084017](#) [802-10-012-10-002000](#) [1112640](#) [1112639](#) [000-34000](#) [0009482033](#) [0009507031](#) [57102-S06-03LF](#) [57202-S52-04LF](#) [PCN6-15S-2.5E](#) [0039019024](#) [58102-G61-06LF](#) [582553-1](#) [0009485154](#) [0009508121](#) [0022285053](#) [0050291907](#) [018731A](#) [LY20-4P-DT1-P1E-BR](#) [02.125.8002.8](#) [60101931](#) [60598-1 \(Cut Strip\)](#) [M1625-3R/100](#) [61062-3](#) [61082-181009](#) [636-1427](#) [638009-1](#) [641938-9](#) [641991-4](#) [644168-1](#) [647662-1](#) [65039-019ELF](#) [65817-002LF](#) [65817-015LF](#) [65863-015LF](#) [66207-023LF](#) [67016-026LF](#) [67046-001LF](#) [67095-007LF](#) [67230-005LF](#)